

HIGH SNR, HIGH AOP ANALOG BOTTOM PORT SISONIC™ MICROPHONE

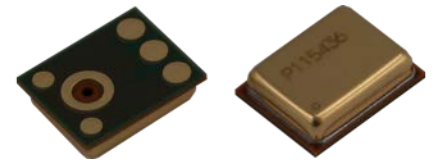

The SPM0687LR5H-1 is a high Signal-to-Noise Ratio (SNR), high Acoustic Overload Point (AOP), bottom port silicon microphone. Using Knowles' proven high performance SiSonic™ MEMS technology, the SPM0687LR5H-1 consists of an acoustic sensor, a low noise input buffer, and a differential output amplifier supporting optional single ended mode. This microphone's high SNR enables far field voice pick up for IoT applications, and its high AOP provides a large dynamic range for barge-in applications. The microphone's low phase distortion lends to superior algorithm performance. Its differential mode configuration improves noise immunity to power supply variations, allowing extension of microphone PCB traces.



PRODUCT FEATURES

- Differential/Single-Ended Output
- Low Distortion /High AOP
- High SNR
- Flat Frequency Response
- Low Current
- Sensitivity Matching
- Bottom Port
- Ultra-Stable Performance
- Omnidirectional
- Standard SMD Reflow
- LGA Package

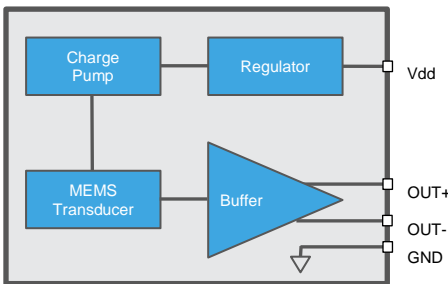

TYPICAL APPLICATIONS

- Voice-Enabled Smart Speaker/Hub (IoT)
- Voice-Enabled Home/Industrial Accessories (Thermostat, Light Bulb, Remote Control, TV)
- Speakerphones
- Active Noise Cancellation (ANC) Headsets
- Digital Action/Still Cameras
- Portable Music Recorders

ABSOLUTE MAXIMUM RATINGS

Table 1: Absolute Maximum Ratings

Parameter	Absolute Maximum Rating	Units
Vdd to Ground	-0.5, +5.0	V
OUT+, OUT- to Ground	-0.3, Vdd+0.3	V
Input Current	±5	mA
Storage Temperature	-40 to +100	°C
Operating Temperature	-30 to +100	°C

Stresses exceeding these "Absolute Maximum Ratings" may cause permanent damage to the device. These are stress ratings only. Functional operation at these or any other conditions beyond those indicated under "Acoustic & Electrical Specifications" is not implied. Exposure beyond those indicated under "Acoustic & Electrical Specifications" for extended periods may affect device reliability.



ACOUSTIC & ELECTRICAL SPECIFICATIONS¹

Table 2: General Microphone Specifications

Test Conditions: 23 ±2°C, 55±20% R.H., VDD= 2.75 V, no load, unless otherwise indicated

Parameter	Symbol	Conditions	Min	Typ	Max	Units
Supply Voltage	Vdd		2.3	2.75	3.6	V
Supply Current	Idd	Vdd = 3.6 V	-	365	-	µA
		Vdd = 2.75 V	-	295	-	
Sensitivity	S	94 dB SPL @ 1kHz, Single-Ended	-41	-40	-39	dBV/Pa
		94 dB SPL @ 1kHz, Differential	-35.7	-34.7	-33.7	
Signal to Noise Ratio	SNR	94 dB SPL @ 1kHz, A-weighted, Single-Ended	-	70	-	dB(A)
		94 dB SPL @ 1kHz, A-weighted, Differential	-	69.5	-	
Near-Ultrasonic SNR		94 dB SPL, @ 19 kHz, BW = 18.5 - 20.0 kHz, SE	-	83.9	-	dB
		94 dB SPL, @ 19 kHz, BW = 18.5 - 20.0 kHz, D	-	83.9	-	
Total Harmonic Distortion	THD	94 dB SPL @ 1 kHz	-	0.2	0.5	%
		115 dB SPL @ 1 kHz	-	1.4	-	%
		1% THD @ 1 kHz, S = typ	-	113	-	dB SPL
Acoustic Overload Point	AOP	10% THD @ 1 kHz, S = typ	-	130	-	dB SPL
Low Frequency Rolloff	LFRO	-3dB relative to 1 kHz	-	13	-	Hz
High Frequency Flatness		+3dB relative to 1 kHz	-	13	-	kHz
Resonant Frequency Peak	Fres		-	25	-	kHz
Power Supply Rejection Ratio	PSRR	200 mVpp sinewave @ 1 kHz, Single-Ended	-	90	-	dB
		200 mVpp sinewave @ 1 kHz, Differential	-	85	-	
Power Supply Rejection	PSR+N	200 mVpp 7/8 duty cycle rect. waveform @ 217 Hz, A-weighted, BW = 20 kHz, SE	-	-106.5	-	dBV(A)
		200 mVpp 7/8 duty cycle rect. waveform @ 217 Hz, A-weighted, BW = 20 kHz, Differential	-	-101.3	-	
DC Output			0.59	0.69	0.79	V
DC Offset		OUT+ to OUT-	-	-	±25	mV
Output Load	Cload		-	-	210	pF
	Rload	AC-coupled	7	-	-	kΩ
Output Impedance	Zout	@ 1 kHz	-	300	600	Ω
Sensitivity Drop		Vdd(min) ≤ Vdd ≤ Vdd(max)	-	-	±0.25	dB
Directivity			Omnidirectional			
Polarity		Increasing sound pressure	Increasing Output Voltage			
Startup Time		S within 1 dB of final value, outputs AC coupled	-	-	30	ms

¹ Sensitivity and Supply Current are 100% tested.



Figure 1: Typical Single-Ended Application Circuit

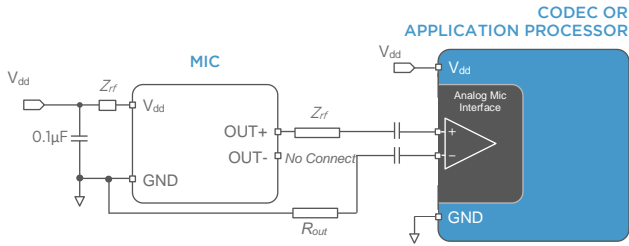

NOTES:

All Ground pins must be connected to ground.
 If necessary to improve RF performance, optional series components (resistors, ferrites, etc.) should be placed closest to the microphone pads.
 Bypass capacitors should be placed next to each Vdd pin for best performance.
 Capacitors near the microphone should not contain Class 2 dielectrics due to their piezoelectric effect.

PERFORMANCE CURVES

Test Conditions: 23 ±2°C, 55±20% R.H., Vdd=2.75 V, no load, unless otherwise indicated

Figure 3: Typical Free Field Magnitude Response and Masks

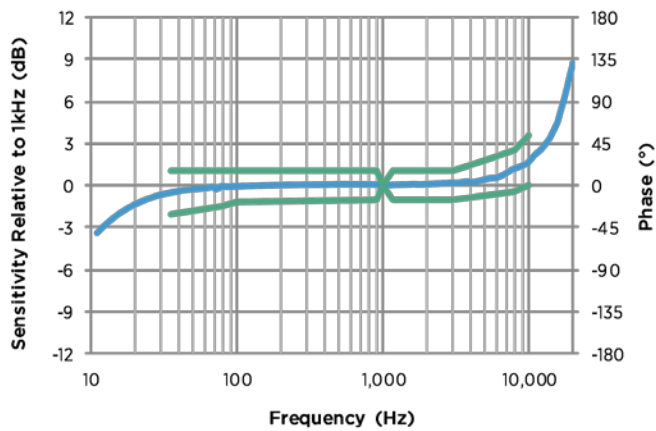

Figure 4: Typical Phase and Group Delay

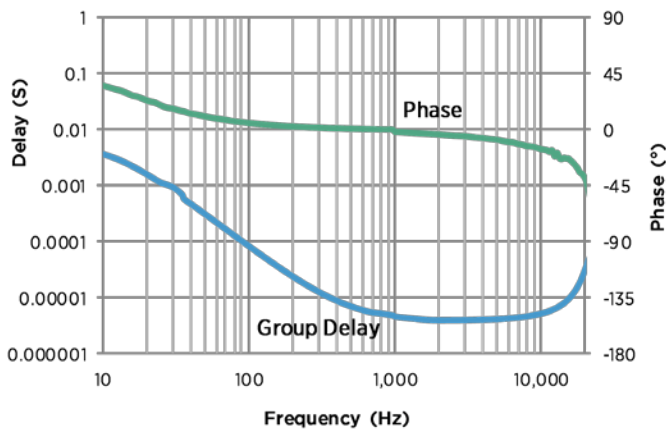

Figure 2: Typical Differential Mode Application Circuit

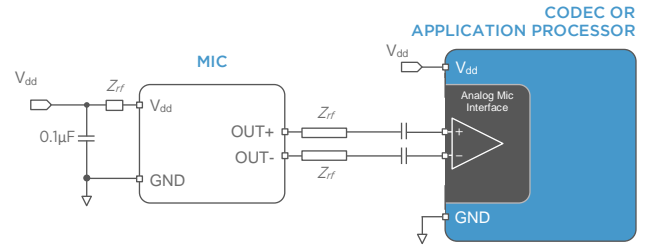

Figure 5: Typical THD vs SPL

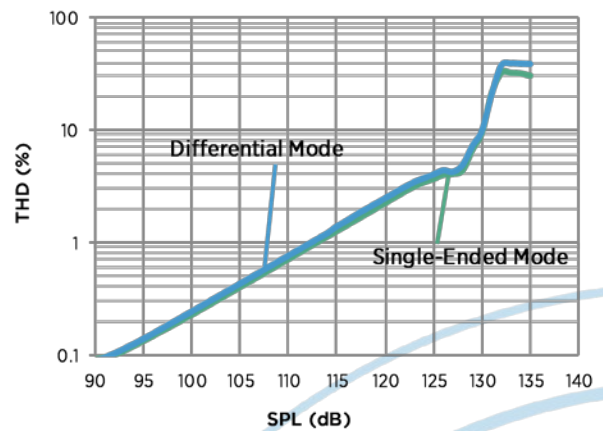

Figure 6: Typical THD vs Frequency

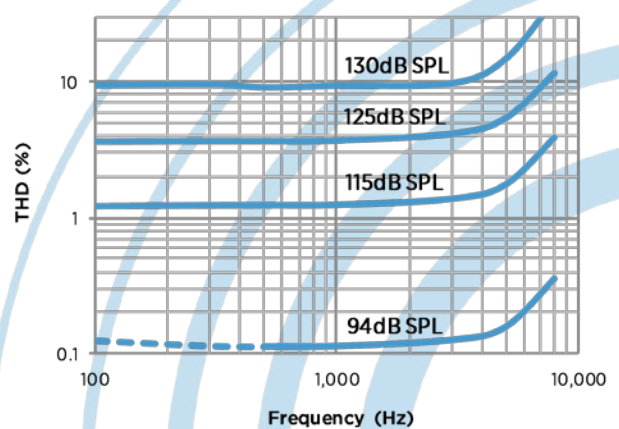

Figure 7: Typical Free Field Ultrasonic Response

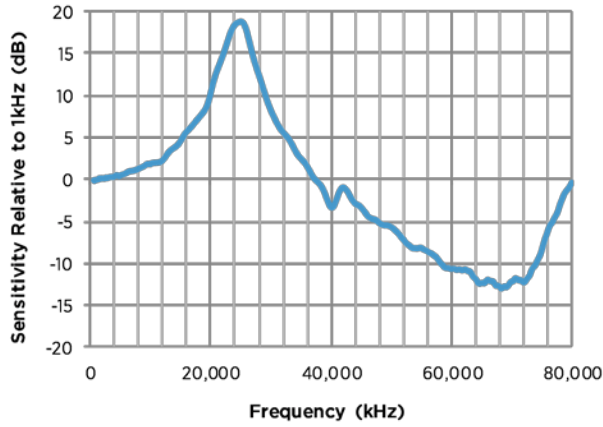

Figure 9: Noise Floor Power Spectral Density

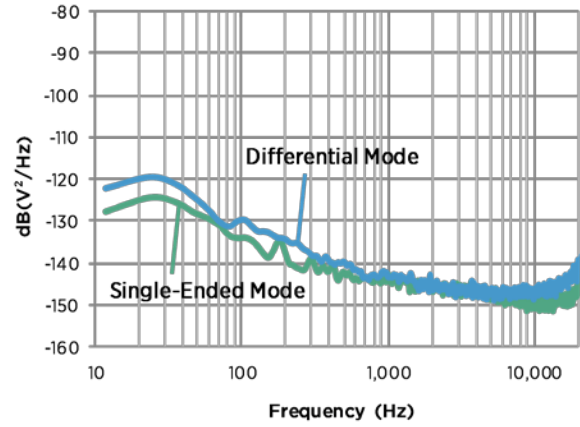

Figure 8: Typical Idd vs Vdd

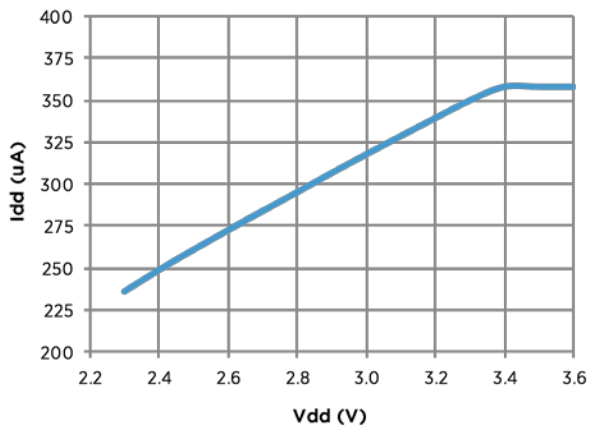
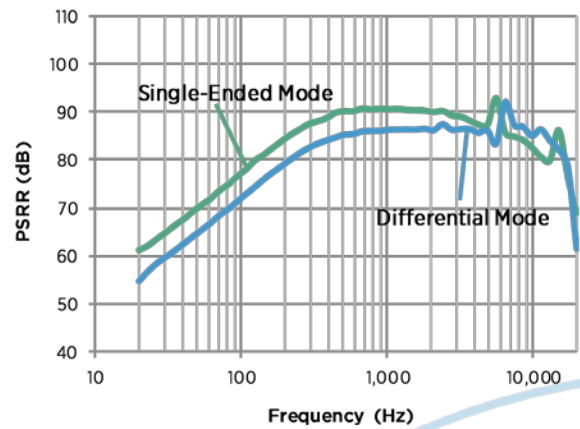
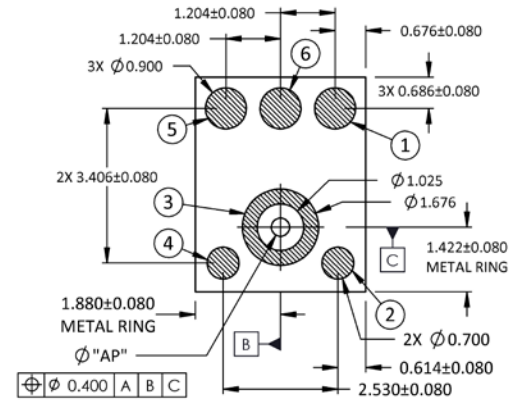
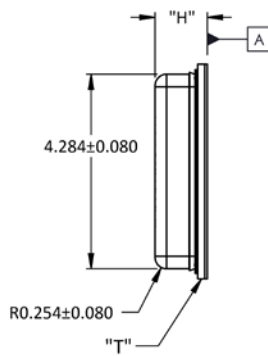
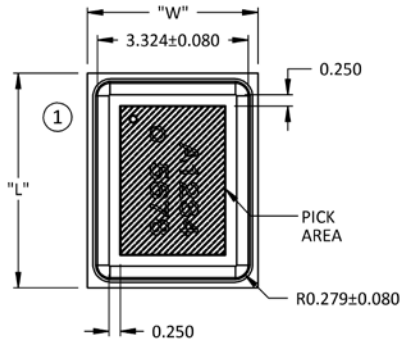

Figure 10: Typical PSRR



MECHANICAL SPECIFICATIONS



Item	Dimension	Tolerance
Length (L)	4.72	±0.10
Width (W)	3.76	±0.10
Height (H)	1.15	±0.10
Acoustic Port (AP)	Ø0.40	±0.05
PCB Thickness (T)	0.30	±0.05

Pin #	Pin Name	Type	Description
1	OUT+	Signal	Non-Inverted Output Signal
2	GROUND	Power	Ground
3	GROUND	Power	Ground
4	GROUND	Power	Ground
5	Vdd	Power	Power Supply
6	OUT-	Signal	Inverted Output Signal

Example Land Pattern

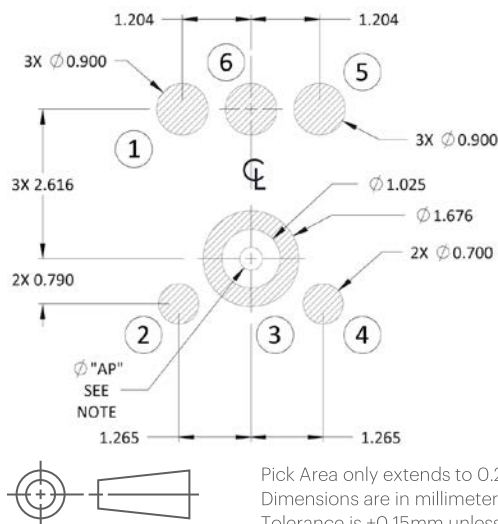

Pick Area only extends to 0.25 mm of any edge or hole unless otherwise specified.
 Dimensions are in millimeters unless otherwise specified.
 Tolerance is ±0.15mm unless otherwise specified.

In the acoustic path, the recommended PCB Hole Diameter is $0.7 \leq D \leq 1.0$ mm, the recommended Gasket Cavity Diameter is $D \geq 1.0$ mm and the recommended Case Hole Diameter is $1.0 \leq D \leq 1.5$ mm. Further optimizations based on application should be performed.

Example Solder Stencil Pattern

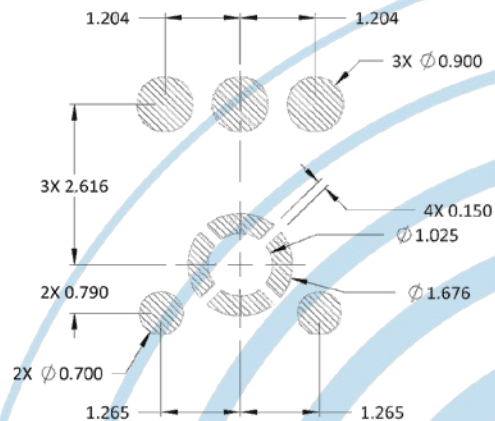

PACKAGING & MARKING DETAIL

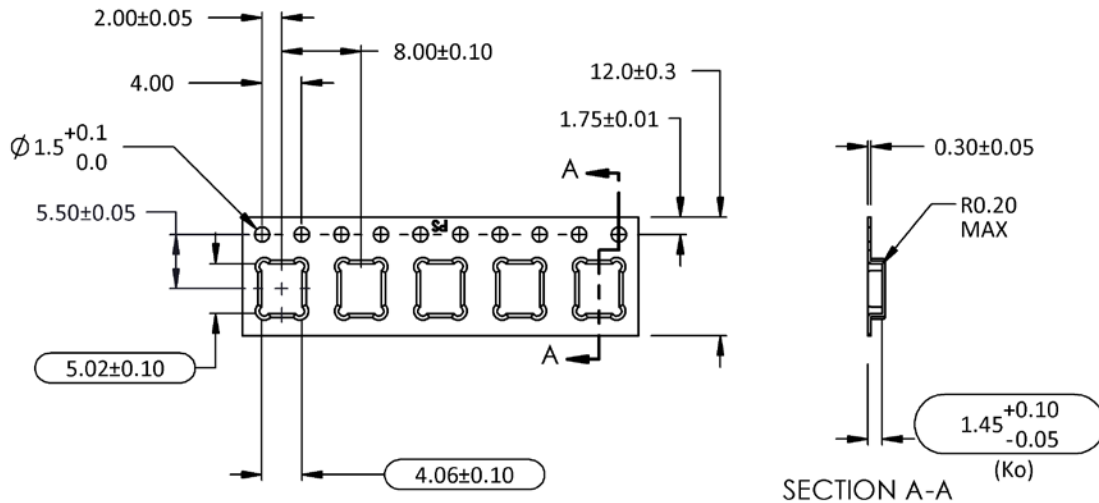

Model Number	Suffix	Reel Diameter	Quantity Per Reel
SPM0687LR5H-1	-6	13"	4800

Component	Surface Resistance (ohms)
Reel	10 ⁵ - 10 ⁹
Carrier Tape	10 ⁵ - 10 ⁹
Cover Tape	10 ⁴ - 10 ¹⁰

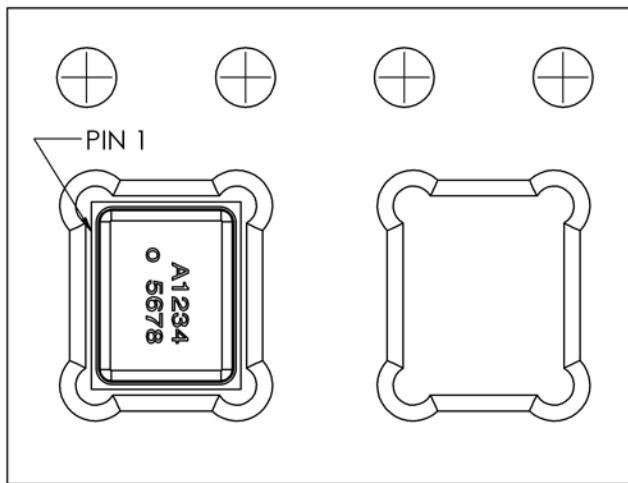

Alpha Character A:
 "S": Knowles SiSonic™ Production
 "E": Knowles Engineering Samples
 "P": Knowles Prototype Samples
 "12345678":
 Unique Job Identification Number for product traceability

NOTES:

- Dimensions are in millimeters unless otherwise specified.
- Vacuum pickup only in the pick area indicated in Mechanical Specifications.
- Tape & reel per EIA-481.
- Labels applied directly to reel and external package.
- Shelf life: Twelve (12) months when devices are stored in the factory-supplied, unopened ESD moisture sensitive bag under the maximum environmental conditions of 30°C, 70% R.H.



RECOMMENDED REFLOW PROFILE

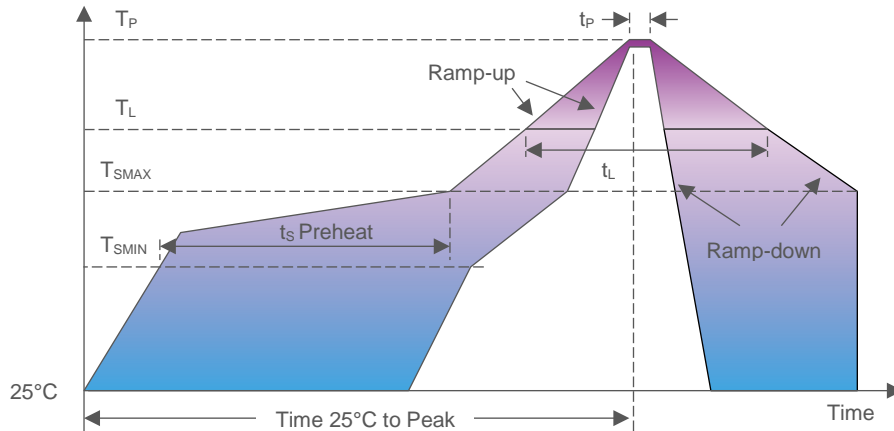

Profile Feature	Pb-Free
Average Ramp-up rate ($T_{S_{MAX}}$ to T_P)	3°C/second max.
Preheat <ul style="list-style-type: none"> • Temperature Min ($T_{S_{MIN}}$) • Temperature Max ($T_{S_{MAX}}$) • Time ($T_{S_{MIN}}$ to $T_{S_{MAX}}$) (t_s) 	150°C 200°C 60-180 seconds
Time maintained above: <ul style="list-style-type: none"> • Temperature (T_L) • Time (t_L) 	217°C 60-150 seconds
Peak Temperature (T_P)	260°C
Time within 5°C of actual Peak Temperature (t_p)	20-40 seconds
Ramp-down rate (T_P to $T_{S_{MAX}}$)	6°C/second max
Time 25°C to Peak Temperature	8 minutes max

NOTES:

Based on IPC/JDEC J-STD-020 Revision C.

All temperatures refer to topside of the package, measured on the package body surface.

The actual reflow profile used should be optimized based on the reflow requirements of all components, board design, solder paste formulation and reflow equipment used. Details of recommended handling and manufacturing processes can be found in AN25 SMT Manufacturing Guidelines for SiSonic™ Microphones.

ADDITIONAL NOTES

- MSL (moisture sensitivity level) Class 1.
- Maximum of 3 reflow cycles is recommended.
- In order to minimize device damage:
 - Do not board wash or clean after the reflow process.
 - Do not brush board with or without solvents after the reflow process.
 - Do not directly expose to ultrasonic processing, welding, or cleaning.
 - Do not insert any object in port hole of device at any time.
 - Do not apply over 30 psi of air pressure into the port hole.
 - Do not pull a vacuum over port hole of the microphone.
 - Do not apply a vacuum when repacking into sealed bags at a rate faster than 0.5 atm/sec.
 - Do not directly expose to vapor phase soldering.



MATERIALS STATEMENT

Meets the requirements of the European RoHS directive 2011/65/EC as amended.

Meets the requirements of the industry standard IEC 61249-2-21:2003 for halogenated substances and Knowles Green Materials Standards Policy section on Halogen-Free.

Product is Beryllium Free according to limits specified on the Knowles Hazardous Material List (HSL for Products).

Ozone depleting substances are not used in the product or the processes used to make the product, including compounds listed in Annex A, B, and C of the "Montreal Protocol on Substances That Deplete the Ozone Layer.

RELIABILITY SPECIFICATIONS

Test	Description
Thermal Shock	100 cycles of air-air thermal shock from -40°C to +125°C with 15 minute soaks (IEC 68-2-4)
High Temperature Storage	+105°C environment for 1,000 hours (IEC 68-2-2 Test Ba)
Low Temperature Storage	-40°C environment for 1,000 hours (IEC 68-2-1 Test Aa)
High Temperature Bias	+105°C environment while under bias for 1,000 hours (IEC 68-2-2 Test Ba)
Low Temperature Bias	-40°C environment while under bias for 1,000 hours (IEC 68-2-1 Test Aa)
Temperature/Humidity Bias	+85°C/85% R.H. environment while under bias for 1,000 hours (JESD22-A101A-B)
Vibration	12 minutes in each X, Y, Z axis from 20 to 2,000 Hz with peak acceleration of 20 G (MIL 883E, Method 2007.2,A)
ESD-HBM	3 discharges at ±2kV direct contact to I/O pins (MIL 883E, Method 3015.7)
ESD-LID/GND	3 discharges at ±8kV direct contact to lid when unit is grounded (IEC 61000-4-2)
ESD-MM	3 discharges at ±200V direct contact to IO pins (ESD STM5.2)
Reflow	5 reflow cycles with peak temperature of +260°C
Mechanical Shock	3 pulses of 10,000 G in each of the X, Y, and Z directions (IEC 68-2-27 Test Ea)

NOTES:

Microphones meet all acoustic and electrical specifications before and after reliability testing, except sensitivity which can deviate up to 3dB.

After 3 reflow cycles, the sensitivity of the microphones shall not deviate more than 1 dB from its initial value.



