

Datasheet SHTC3

Humidity and Temperature Sensor IC

- Ultra-low power consumption
- Full battery supply voltage range (1.62 - 3.6 V)
- Small DFN package: 2 × 2 × 0.75 mm³
- Typical accuracy: ±2 %RH and ±0.2 °C
- Fully calibrated and reflow solderable
- Power-up and measurement within 1 ms



Product Summary

The SHTC3 is a digital humidity and temperature sensor designed especially for battery-driven high-volume consumer electronics applications. This sensor is strictly designed to overcome conventional limits for size, power consumption, and performance to price ratio in order to fulfill current and future requirements. Sensirion's CMOSens[®] technology offers a complete sensor system on a single chip, consisting of a capacitive humidity sensor, a bandgap temperature sensor, analog and digital signal processing, A/D converter, calibration data memory, and a digital communication interface supporting I²C Fast Mode Plus. The small 2 × 2 × 0.75 mm³ DFN package enables applications in even the most limited of spaces.

The sensor covers a humidity measurement range of 0 to 100 %RH and a temperature measurement range of - 40 °C to 125 °C with a typical accuracy of ±2 %RH and ±0.2°C. The broad supply voltage of 1.62 V to 3.6 V and an energy budget below 1 μJ per measurement make the SHTC3 suitable for mobile or wireless applications powered by batteries. With the industry-proven quality and reliability of Sensirion's humidity and temperature sensors and constant accuracy over a large measurement range, the SHTC3 offers best performance-to-price ratio. Tape and reel packaging together with suitability for standard SMD assembly processes make the SHTC3 predestined for high-volume applications.

Benefits of Sensirion's CMOSens[®] Technology

- High reliability and long-term stability
- Industry-proven technology with a track record of more than 15 years
- Designed for mass production
- Optimized for lowest cost
- High signal-to-noise ratio

Contents of this Data Sheet

1	Humidity and Temperature Sensor Specifications	2
2	Electrical Specifications	3
3	Timing Specifications	4
4	Interface Specifications	6
5	Operation and Communication	6
6	Quality	9
7	Packaging and Traceability	9
8	Ordering Information	9
9	Technical Drawings	10
10	Further Information	11

Block diagram

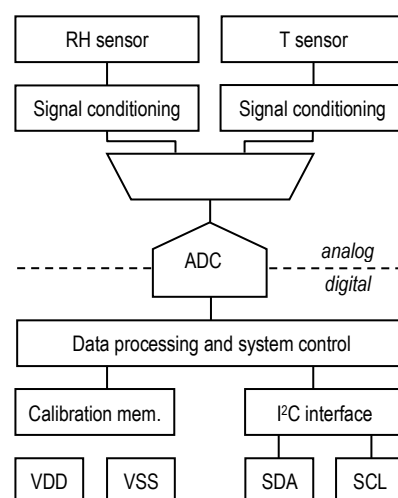

Figure 1 Functional block diagram of the SHTC3.

1 Humidity and Temperature Sensor Specifications

Relative Humidity

Parameter	Condition	Value	Unit
Accuracy tolerance ¹	Typ.	±2.0	%RH
	Max.	see Figure 2	%RH
Repeatability ²	-	0.1	%RH
Resolution ³	-	0.01	%RH
Hysteresis	-	±1	%RH
Specified range ⁴	extended ⁵	0 to 100	%RH
Response time ⁶	τ 63%	8	s
Long-term drift ⁷	Typ.	<0.25	%RH/y

Table 1 Humidity sensor specifications.

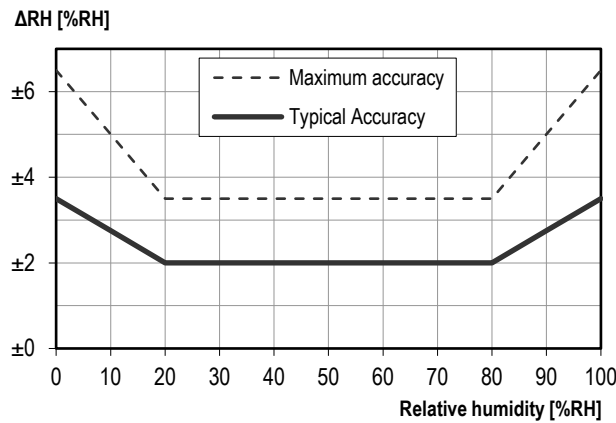

Figure 2 Typical and maximal tolerance for relative humidity in %RH at 25 °C.

Temperature

Parameter	Condition	Value	Unit
Accuracy tolerance ¹	Typ.	±0.2	°C
	Max.	see Figure 3	°C
Repeatability ²	-	0.1	°C
Resolution ³	-	0.01	°C
Specified range ⁴	-	-40 to +125	°C
Response time ⁸	τ 63%	<5 to 30	s
Long-term drift ⁹	Typ.	<0.02	°C/y

Table 2 Temperature sensor specifications.

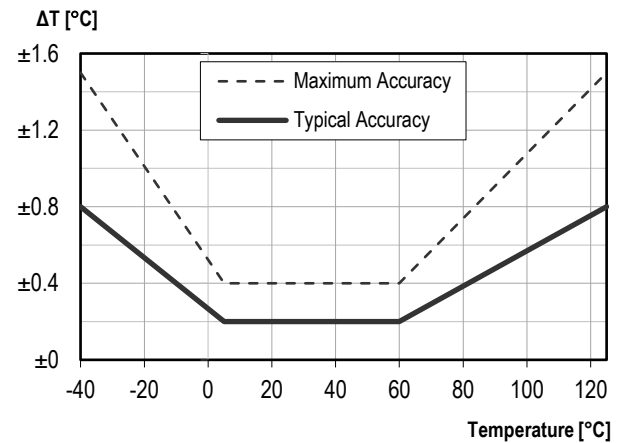

Figure 3 Typical and maximal tolerance for temperature sensor in °C.

¹ For definition of typ. and max. accuracy tolerance, please refer to the document "Sensirion Humidity Sensor Specification Statement". Specification applies to normal mode.

² The stated repeatability is 3 times the standard deviation (3σ) of multiple consecutive measurement values at constant conditions and is a measure for the noise on the physical sensor output. Specification applies to normal mode.

³ Resolution of A/D converter. Specification applies to normal mode.

⁴ Specified range refers to the range for which the humidity or temperature sensor specification is guaranteed.

⁵ For details about recommended humidity and temperature operating range, please refer to section 1.2.

⁶ Time for achieving 63% of a humidity step function, valid at 25°C and 1 m/s airflow. Humidity response time in the application depends on the design-in of the sensor.

⁷ Typical value for operation in normal RH/T operating range. Max. value is < 0.5 %RH/y. Value may be higher in environments with vaporized solvents, out-gassing tapes, adhesives, packaging materials, etc. For more details please refer to Handling Instructions.

⁸ Temperature response time depends on heat conductivity of sensor substrate and design-in of sensor in application.

⁹ Max. value is < 0.04°C/y.

1.1 RH Accuracy at Various Temperatures

Typical RH accuracy at 25°C is defined in Figure 2. For other temperatures, typical accuracy has been evaluated to be as displayed in Figure 4.

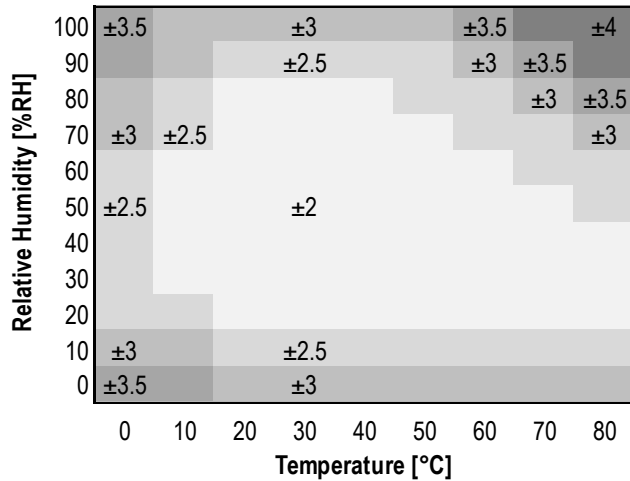

Figure 4 Typical accuracy of relative humidity measurements given in %RH for temperatures 0°C ... 80°C.

1.2 Recommended Operating Conditions

The sensor performs best when operated within the recommended normal temperature and humidity range of 5 – 60 °C and 20 – 80 %RH, respectively. Long-term exposure to conditions outside the normal range, especially at high humidity, may temporarily offset the RH signal (e.g. +3%RH after 60h at >80%RH). After returning to normal temperature and humidity range the sensor will slowly come back to its calibration state by itself. Prolonged exposure to extreme conditions may accelerate ageing.

To ensure stable operation of the humidity sensor, the conditions described in the document “SHTxx Assembly of SMD Packages”, section “Storage and Handling Instructions” regarding exposure to volatile organic compounds have to be met. Please note as well that this does apply not only to transportation and manufacturing, but also to operation of the SHTC3.

2 Electrical Specifications

2.1 Electrical Characteristics

Default conditions of 25 °C and 3.3 V supply voltage apply to values in the table below, unless otherwise stated.

Parameter	Symbol	Conditions	Min	Typ.	Max	Units	Comments	
Supply voltage	V _{DD}		1.62	3.3	3.6	V	-	
Power-up/down level	V _{POR}	Static power supply	1.28	1.4	1.55	V	-	
Supply current	I _{DD}	Idle state	-	45	70	µA	After power-up the sensor remains in the idle state unless a sleep command is issued or other data transmission is active	
		Sleep Mode	-	0.3	0.6	µA	When in sleep mode, the sensor requires a dedicated wake-up command to enable further I ² C communication	
		Measurement	Normal Mode	-	430	900	µA	Average current consumption while the sensor is measuring
			Low Power M.	-	270	570	µA	
		Average	Normal Mode	-	4.9	-	µA	Average current consumption (continuous operation with one measurement per second)
Low Power M.	-		0.5	-	µA	Average current consumption (continuous operation with one measurement per second)		
Low level input voltage	V _{IL}	-	-	-	0.42 V _{DD}	V	-	
High level input voltage	V _{IH}	-	0.7 V _{DD}	-	-	V	-	
Low level output voltage	V _{OL}	3 mA sink current	-	-	0.2 V _{DD}	V	-	

Table 3 Electrical specifications.

2.2 Absolute Maximum Ratings

Stress levels beyond the limits listed in Table 4 may cause permanent damage to the device. These are stress ratings only and functional operation of the device at these conditions cannot be guaranteed. Exposure to the absolute maximum rating conditions for extended periods may affect the reliability of the device. Parameters are only tested each at a time.

Parameter	Rating
Supply voltage, V_{DD}	-0.3 to +4 V
Operating temperature range	-40 to +125 °C
Storage temperature range ¹⁰	-40 to +125 °C
ESD HBM (human body model) ¹¹	-2 to 2 kV
ESD CDM (change device model) ¹²	-500 to 500 V
Latch up, JESD78 Class II, 125°C	-100 to 100 mA

Table 4 Absolute maximum ratings.

3 Timing Specifications

3.1 Sensor System Timings

Default conditions of 25 °C and 3.3 V supply voltage apply to values the table below, unless otherwise stated. Max. values are measured at -40 °C.

Parameter	Symbol	Conditions	Min.	Typ.	Max.	Units	Comments	
Power-up time	t_{PU}	After hard reset, $V_{DD} \geq V_{POR}$	-	180	240	μ s	Time between V_{DD} reaching V_{PU} and sensor entering the idle state	
Soft reset time	t_{SR}	After soft reset.	-	180	240	μ s	Time between ACK of soft reset command and sensor entering the idle state	
Measurement duration	t_{MEAS}	Average	Normal Mode	-	10.8	12.1	ms	Duration for a humidity and temperature measurement
			Low Power M.	-	0.7	0.8		

Table 5 System timing specifications.

¹⁰ The recommended storage temperature range is 10-50°C. Please consult the document "SHTxx Handling Instructions" for more information.

¹¹ According to ANSI/ESDA/JEDEC JS-001-2014; AEC-Q100-002.

¹² According to ANSI/ESD S5.3.1-2009; AEC-Q100-011.

3.2 Communication Timings

Default conditions of 25 °C and 3.3 V supply voltage apply to values in the table below, unless otherwise stated.

Parameter	Symbol	Conditions	Min.	Typ.	Max.	Units	Comments
SCL clock frequency	f_{SCL}	-	0	-	1	MHz	-
Hold time (repeated) START condition	$t_{HD,STA}$	After this period, the first clock pulse is generated	260	-	-	ns	-
LOW period of the SCL clock	t_{LOW}	-	500	-	-	ns	-
HIGH period of the SCL clock	t_{HIGH}	-	260	-	-	ns	-
Set-up time for a repeated START condition	$t_{SU,STA}$	-	260	-	-	ns	-
SDA hold time	$t_{HD,DAT}$	-	0	-	-	-	-
SDA set-up time	$t_{SU,DAT}$	-	50	-	-	ns	-
SCL/SDA rise time	t_R	-	-	-	120	ns	-
SCL/SDA fall time	t_F	-	-	-	120	ns	-
SDA valid time	$t_{VD,DAT}$	-	-	-	400	ns	-
Set-up time for STOP condition	$t_{SU,STO}$	-	260	-	-	ns	-
Capacitive load on bus line	C_B	-	-	-	550	pF	-

Table 6 Communication timing specifications. The numbers above are values according to the I²C Fast Mode Plus specification.

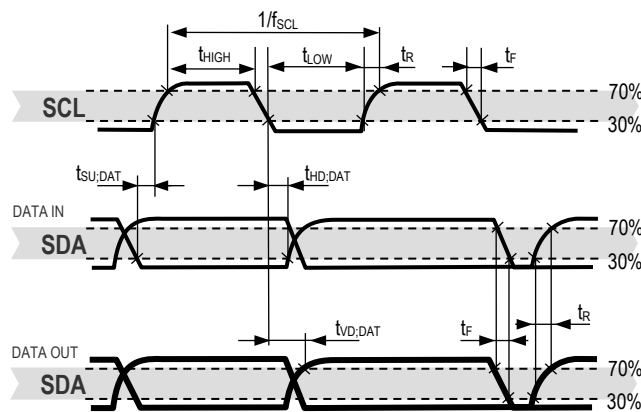

Figure 5 Timing diagram for digital input/output pads. SDA directions as seen from the sensor. Bold SDA lines are controlled by the sensor, plain SDA lines are controlled by the micro-controller. Note that SDA valid read time is triggered by falling edge of preceding toggle.

4 Interface Specifications

The SHTC3 supports I²C Fast Mode Plus (SCL clock frequency from 0 to 1 MHz) with clock stretching. For detailed information on the I²C protocol, refer to NXP I²C-bus specification and user manual UM10204, Rev. 6, April 4th, 2014.

The SHTC3 comes in a 4-pin package – see Table 7.

Pin	Name	Comments
1	VDD	Supply voltage
2	SCL	Serial clock, bidirectional
3	SDA	Serial data, bidirectional
4	VSS	Ground

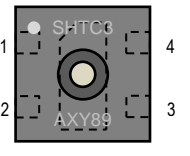

Table 7 SHTC3 pin assignment (top view). The center pad is internally connected to VSS.

Power-supply pins supply voltage (VDD) and ground (VSS) must be decoupled with a 100 nF capacitor that shall be placed as close to the sensor as possible – see Figure 6.

SCL is used to synchronize the communication between the microcontroller and the sensor. The master must keep the clock frequency within 0 to 1 MHz as specified in Table 6. The SHTC3 may pull down the SCL line when clock stretching is enabled.

The SDA pin is used to transfer data in and out of the sensor. For safe communication, the timing specifications defined in the I²C manual must be met.

To avoid signal contention, the microcontroller must only drive SDA and SCL low. External pull-up resistors (e.g. 10 kΩ) are required to pull the signal high. For dimensioning resistor sizes please take the bus capacity requirements into account. Note that pull-up resistors may be included in I/O circuits of microcontrollers.

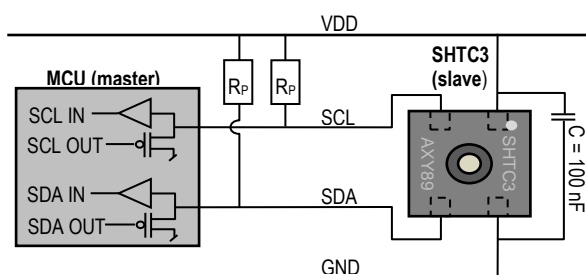

Figure 6 Typical application circuit, including pull-up resistors R_p and decoupling of VDD and VSS by a capacitor.

For good performance of the SHTC3 in the application, the center pad of the SHTC3 offers the best thermal contact to

the temperature sensor. For more information on design-in, please refer to the document “SHTxx Design Guide”.

For mechanical reasons the center pad should be soldered. Electrically, the center pad is internally connected to GND and may be connected to the GND net on the PCB additionally.

5 Operation and Communication

All commands and memory locations of the SHTC3 are mapped to a 16-bit address space which can be accessed via the I²C protocol.

5.1 I²C Address

The I²C device address is given Table 8:

SHTC3	Hex. Code	Bin. Code
I ² C address	0x70	111'0000

Table 8 SHTC3 I²C device address.

Each transmission sequence begins with START condition (S) and ends with an (optional) STOP condition (P) as described in the I²C-bus specification.

5.2 Power-Up, Sleep, Wakeup

Upon VDD reaching the power-up voltage level V_{POR} , the SHTC3 enters the idle state after a duration of t_{PU} . After that, the sensor should be set to sleep mode with the command given in Table 9¹³.

Command	Hex. Code	Bin. Code
Sleep	0xB098	1011'0000'1001'1000

Table 9 Sleep command of the sensor.

When the sensor is in sleep mode, it requires the following wake-up command before any further communication, see Table 10:

Command	Hex. Code	Bin. Code
Wakeup	0x3517	0011'0101'0001'0111

Table 10 Wake-up command of the sensor.

5.3 Measurement Commands

The SHTC3 provides a clock-stretching option and the order of the signal return can be selected. These parameters are selected by dedicated measurement commands as summarized in Table 11. N. B.: Each measurement command triggers always both, a temperature *and* a relative humidity measurement.

¹³ If an immediate sensor signal is desired, sending the sensor to sleep mode can be omitted. Not sending the sensor to sleep mode for an extended amount of time keeps up the current consumption of the sensor.

	Clock Stretching Enabled		Clock Stretching Disabled	
	Read T First	Read RH First	Read T First	Read RH First
Normal Mode	0x7CA2	0x5C24	0x7866	0x58E0
Low Power M.	0x6458	0x44DE	0x609C	0x401A

Table 11 Measurement commands.

5.4 Measuring and Reading the Signals

Each measurement cycle contains a set of four commands, each initiated by the I2C START condition and ended by the I2C STOP condition:

1. Wakeup command
2. Measurement command
3. Read out command
4. Sleep command

An exemplary measurement set is shown in Figure 7

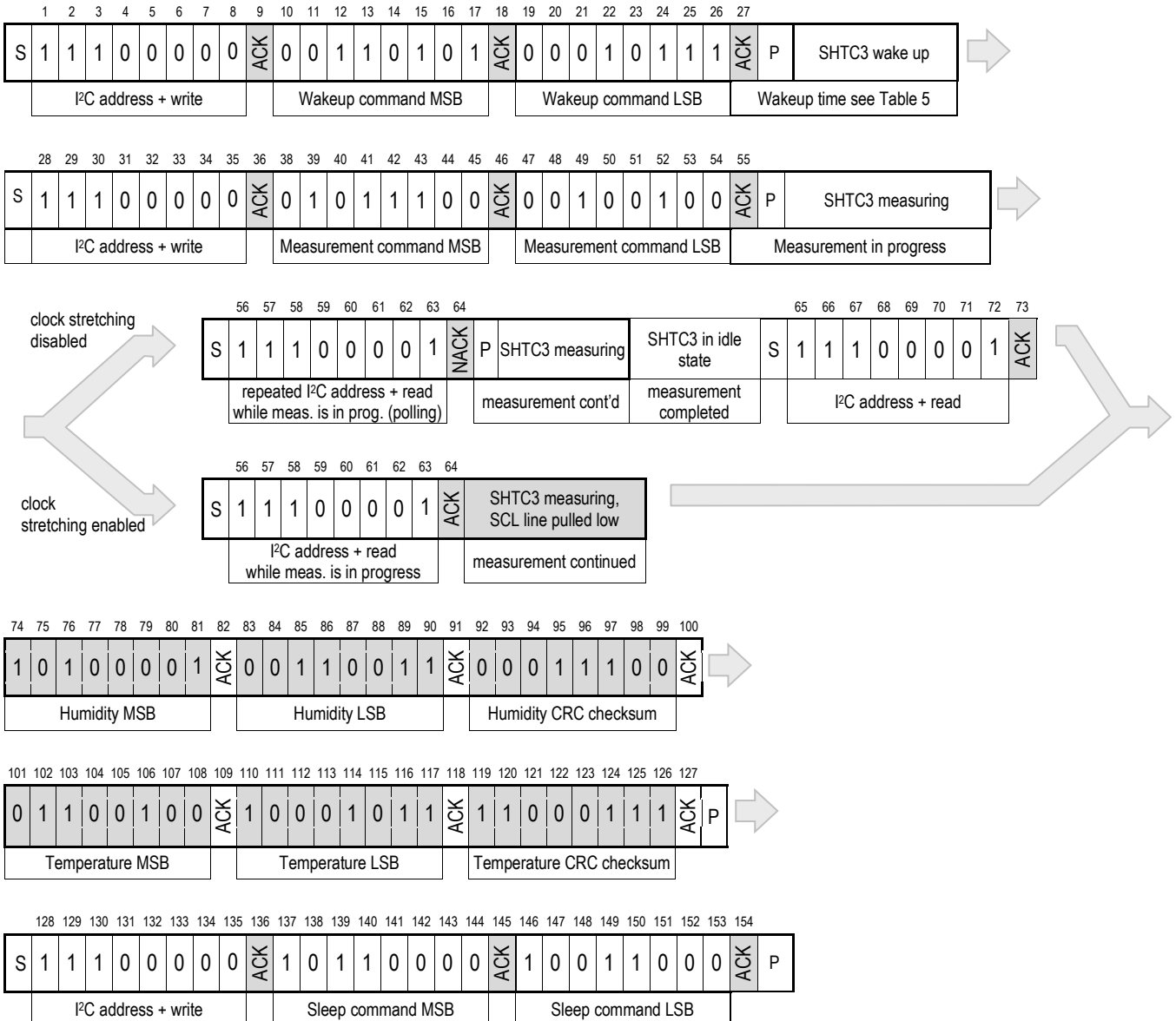

Figure 7 Communication sequence for waking up the sensor, starting a measurement and reading measurement results displaying both clock stretching options.

The numerical example corresponds to a read humidity-first command with clock stretching enabled. The physical values of the transmitted measurement results are 63 %RH and 23.7 °C. Clear blocks are controlled by the microcontroller, grey blocks by the SHTC3.

5.5 Sensor Behavior during Measurement and Clock Stretching

In general, the sensor does not respond to any I²C activity during measurement, i.e. I²C read and write headers are not acknowledged (NACK). However, when clock stretching has been enabled by using a corresponding measurement command, the sensor responds to a read header with an ACK and subsequently pulls down the SCL line until the measurement is complete. As soon as the measurement is complete, the sensor starts sending the measurement results.

During measurement, the sensor has a current consumption according to Table 3.

For best possible repeatability of humidity and temperature measurements, it is recommended to avoid any communication on the I²C bus while the SHTC3 is measuring. For more information, see the application note "Optimization of Repeatability".

5.6 Readout of Measurement Results

After a measurement command has been issued and the sensor has completed the measurement, the master can read the measurement results by sending a START condition followed by an I²C read header. The sensor will acknowledge the reception of the read header and send two bytes of data followed by one byte CRC checksum and another two bytes of data followed by one byte CRC checksum. Each byte must be acknowledged by the microcontroller with an ACK condition for the sensor to continue sending data. If the SHTC3 does not receive an ACK from the master after any byte of data, it will not continue sending data.

The I²C master can abort the read transfer with a NACK condition after any data byte if it is not interested in subsequent data, e.g. the CRC byte or the second measurement result, in order to save time.

In case the user needs humidity and temperature data but does not want to process CRC data, it is recommended to read the first two bytes of data with the CRC byte (without processing the CRC data) and abort the read transfer after reading the second two data bytes with a NACK. This procedure is more time efficient than starting two different measurements and aborting the read transfer after the first two data bytes each time.

5.7 Soft Reset

The SHTC3 provides a soft reset mechanism that forces the system into a well-defined state without removing the power supply. If the system is in its idle state (i.e. if no measurement is in progress) the soft reset command can be sent to SHTC3 according to Table 12. This triggers the

sensor to reset all internal state machines and reload calibration data from the memory.

Command	Hex. Code	Bin. Code
Software reset	0x805D	1000'0000'0101'1101

Table 12 Soft reset command.

5.8 Reset through General Call

Additionally, a reset of the sensor can also be generated using the "general call" mode according to I²C-bus specification¹⁴. This generates a reset which is functionally identical to using the nReset pin. It is important to understand that a reset generated in this way is not device specific. All devices on the same I²C bus that support the general call mode will perform a reset. Additionally, this command only works when the sensor is able to process I²C commands. The appropriate command consists of two bytes and is shown in Table 13.

Command	Code
Address byte	0x00
Second byte	0x06
Reset command using the general call address	0x0006

Table 13 Reset through the general call address (clear blocks are controlled by the microcontroller, grey blocks by the sensor)

5.9 Read-out of ID Register

The SHTC3 has an ID register which contains an SHTC3-specific product code. The read-out of the ID register can be used to verify the presence of the sensor and proper communication. The command to read the ID register is shown in Table 14.

Command	Hex. Code	Bin. Code
Read ID register	0xEFC8	1110'1111'1100'1000

Table 14 Read-out command of ID register.

It needs to be sent to the SHTC3 after an I²C write header. Once the SHTC3 has acknowledged the proper reception of the command, the master can send an I²C read header and the SHTC3 submits the 16-bit ID followed by 8 bits of CRC. The structure of the ID is described in Table 15.

¹⁴ http://www.nxp.com/documents/user_manual/UM10204.pdf

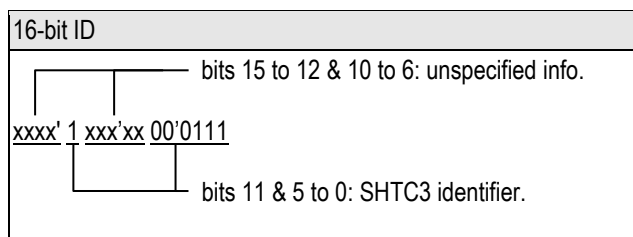

Table 15 Structure of the 16-bit ID. Bits 15:12 & 10:6 of the ID contain unspecified information (marked as “x”), which may vary from sensor to sensor, while bits 11 & 5:0 contain the SHTC3-specific product code.

5.10 Checksum Calculation

The 8-bit CRC checksum transmitted after each data word is generated by a CRC algorithm with the properties displayed in Table 16. The CRC covers the contents of the two previously transmitted data bytes.

Property	Value
Name	CRC-8
Width	8 bits
Polynomial	0x31 ($x^8 + x^5 + x^4 + 1$)
Initialization	0xFF
Reflect input	False
Reflect output	False
Final XOR	0x00
Examples	CRC (0x00) = 0xAC CRC (0xBEEF) = 0x92

Table 16 SHTC3 I²C CRC properties.

5.11 Conversion of Sensor Output

Measurement data is always transferred as 16-bit values. These values are already linearized and temperature compensated by the SHTC3. Humidity and temperature values can be calculated with the formulas in given below.

Relative humidity conversion formula (result in %RH):

$$RH = 100 \cdot \frac{S_{RH}}{2^{16}}$$

Temperature conversion formula (result in °C):

$$T = -45 + 175 \cdot \frac{S_T}{2^{16}}$$

S_{RH} and S_T denote the raw sensor output (as decimal values) for humidity and temperature, respectively.

6 Quality

6.1 Environmental Stability

Qualification of the SHTC3 is performed based on the JEDEC JESD47 qualification test method.

6.2 Material Contents

The device is fully RoHS, REACH and Halogen-Free compliant, e.g. free of Pb, Cd, and Hg.

7 Packaging and Traceability

SHTC3 sensors are provided in a DFN package with an outline of $2 \times 2 \times 0.75 \text{ mm}^3$ and a terminal pitch of 1 mm. DFN stands for dual flat no leads. The humidity sensor opening is centered on the top side of the package.

The sensor chip is made of silicon and is mounted to a lead frame. The latter is made of Cu plated with Ni/Pd/Au. Chip and lead frame are overmolded by an epoxy-based mold compound. Please note that the sidewalls of sensor are diced and therefore these diced lead frame surfaces are not covered with the respective plating.

The Moisture Sensitivity Level classification of the SHTC3 is MSL1, according to IPC/JEDEC J-STD-020.

All SHTC3 sensors are laser marked for easy identification and traceability. The marking on the sensor consists of two lines and a pin-1 indicator. The top line contains the sensor type (SHTC3), the bottom line contains a 5-digit alphanumeric tracking code. The pin-1 indicator is located in the top left corner. See Figure 8 for illustration.

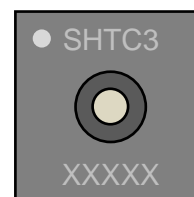

Figure 8 Laser marking on SHTC3, the top line with the pin-1 indicator and the sensor type, the bottom line with the 5-digit alphanumeric tracking code.

Reels are also labeled and provide additional traceability information.

8 Ordering Information

The SHTC3 can be ordered in tape and reel packaging with different sizes, see Table 17. The reels are sealed into antistatic ESD bags. A drawing of the packaging tape with sensor orientation is shown in Figure 11.

Quantity	Packaging	Reel Diameter	Order Number
2500	Tape & Reel	180 mm (7 inch)	3.000.047
10'000	Tape & Reel	330 mm (13 inch)	1-101681-01

Table 17 SHTC3 ordering options.

Revision History

Date	Version	Page(s)	Changes
July 2018	1	all	Initial version