

**SCHOTTKY BARRIER RECTIFIER**

**VOLTAGE RANGE 20 to 200 Volts CURRENT 16.0 Ampere**

**FEATURES**

- \* Low switching noise
- \* Low forward voltage drop
- \* Low thermal resistance
- \* High current capability
- \* High switching capability
- \* High surge capability
- \* High reliability

**MECHANICAL DATA**

- \* Case: To-220 molded plastic
- \* Epoxy: Device has UL flammability classification 94V-0
- \* Lead: MIL-STD-202E method 208C guaranteed
- \* Mounting position: Any
- \* Weight: 2.24 grams



**TO-220**

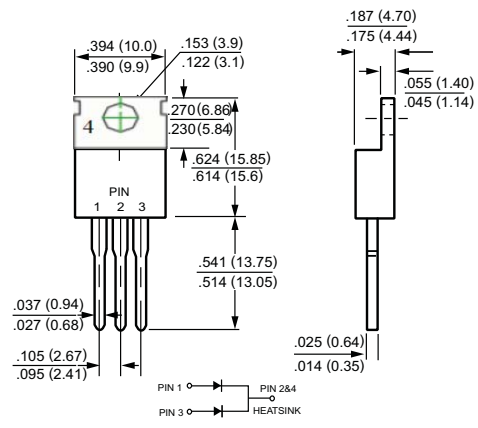

Dimensions in inches and (millimeters)

**MAXIMUM RATINGS AND ELECTRICAL CHARACTERISTICS**

Ratings at 25 °C ambient temperature unless otherwise specified.  
Single phase, half wave, 60 Hz, resistive or inductive load.  
For capacitive load, derate current by 20%.

**MAXIMUM RATINGS (@ TA=25 °C unless otherwise noted)**

RATINGS	SYMBOL	SR1620C	SR1630C	SR1635C	SR1640C	SR1645C	SR1650C	SR1660C	SR1680C	SR16100C	SR16150C	SR16200C	UNITS
Maximum Recurrent Peak Reverse Voltage	$V_{RRM}$	20	30	35	40	45	50	60	80	100	150	200	Volts
Maximum RMS Voltage	$V_{RMS}$	14	21	25	28	32	35	42	56	70	105	140	Volts
Maximum DC Blocking Voltage	$V_{DC}$	20	30	35	40	45	50	60	80	100	150	200	Volts
Maximum Average Forward Rectified Current at Derating Case Temperature	$I_O$	16.0											Amps
Peak Forward Surge Current 8.3 ms single half sine-wave superimposed on rated load (JEDEC method)	$I_{FSM}$	150											Amps
Typical Current Squared Time	$I^2t$	93.37											A <sup>2</sup> /Sec
Typical Thermal Resistance (Note 1)	$R_{\theta JC}$	2.0											°C/W
	$R_{\theta JA}$	40											
Typical Junction Capacitance (Note 3)	$C_J$	700					500						pF
Operating Temperature Range	$T_J$	150											°C
Storage Temperature Range	$T_{STG}$	-55 to + 150											°C

**ELECTRICAL CHARACTERISTICS (@TA=25 °C unless otherwise noted)**

CHARACTERISTICS	SYMBOL	SR1620C	SR1630C	SR1635C	SR1640C	SR1645C	SR1650C	SR1660C	SR1680C	SR16100C	SR16150C	SR16200C	UNITS	
Maximum Instantaneous Forward Voltage at 8.0A DC	$V_F$	.65					.75			.85				Volts
Maximum Average Reverse Current at Rated DC Blocking Voltage	$I_R$	@ $T_A = 25^\circ C$						0.2						mA
		@ $T_A = 100^\circ C$						2						mA

- NOTES : 1. Thermal Resistance : Heat-sink mounted.  
2. Suffix "A" = Common Anode.  
3. Measured at 1 MHz and applied reverse voltage of 4.0 volts.  
4. "Fully ROHS compliant", "100% Sn plating (Pb-free)".

# RATING AND CHARACTERISTICS CURVES ( SR1620C THRU SR16200C )

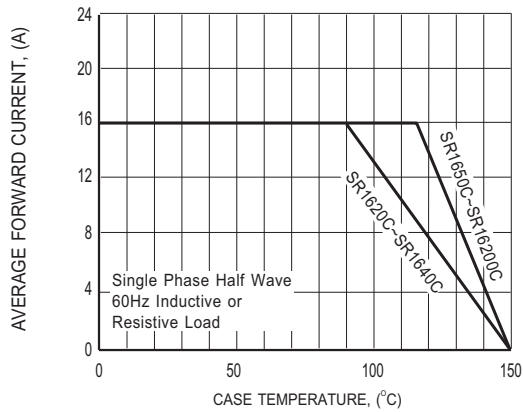

FIG.1 TYPICAL FORWARD CURRENT DERATING CURVE

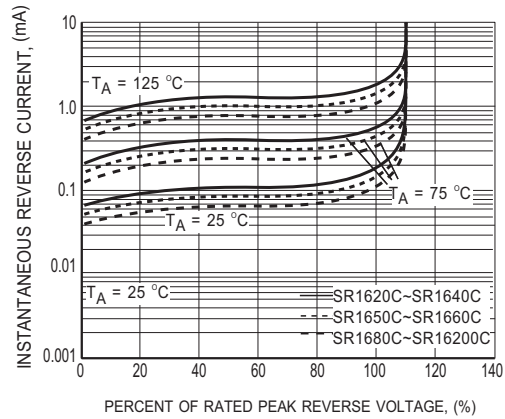

FIG.2 TYPICAL REVERSE CHARACTERISTICS

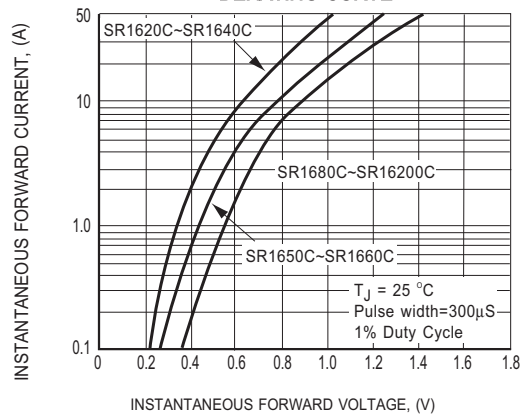

FIG.3 TYPICAL INSTANTANEOUS FORWARD CHARACTERISTICS

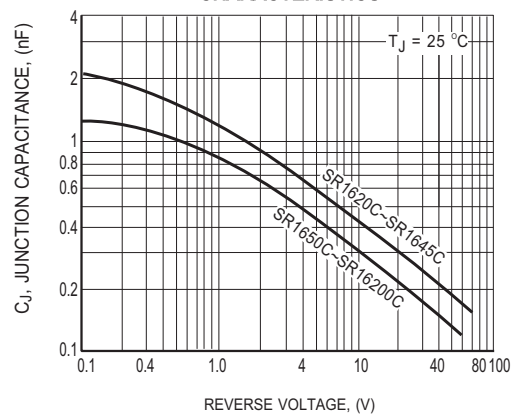

FIG.4 TYPICAL JUNCTION CAPACITANCE

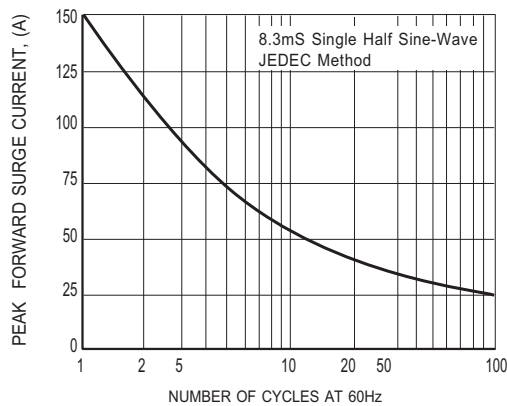

FIG.5 MAXIMUM NON-REPETITIVE FORWARD SURGE CURRENT



## Attachment information about SR16XXC

### 1. Internal Circuit



### 2. Marking on the body

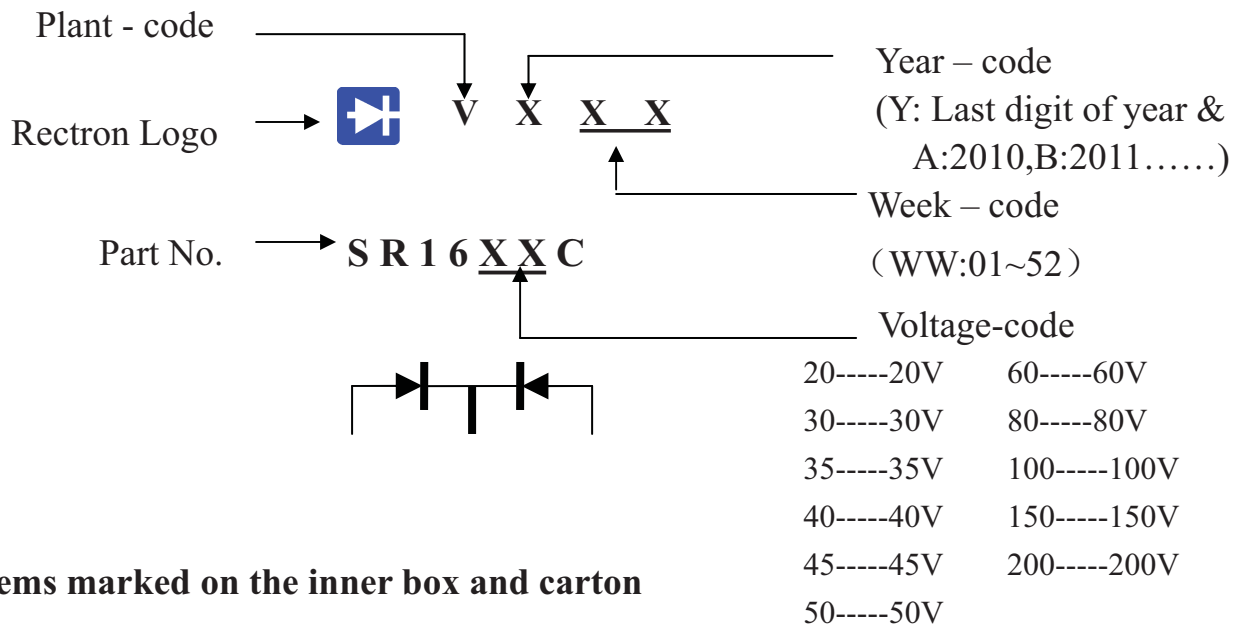

### 3. Items marked on the inner box and carton

#### 3.1 On the box (for -C)

CUSTOMER  
TYPE  
LOT NO.  
QUANTITY  
Q.A.  
DATE

#### 3.2 On the carton

CUSTOMER  
TYPE  
QUANTITY  
LOT NO.  
REMARK

# PACKAGING OF DIODE AND BRIDGE RECTIFIERS

## TUBE PACK

PACKAGE	PACKING CODE	EA PER BOX	INNER BOX SIZE (mm)	CARTON SIZE (mm)	EA PER CARTON	WEIGHT(Kg)
(I)TO-220/TO-220(A)	-C	2,000	550*140*92	572*308*120	4,000	11.80