

Start Guide

SmartStart, SmartFlex, SmartMotion

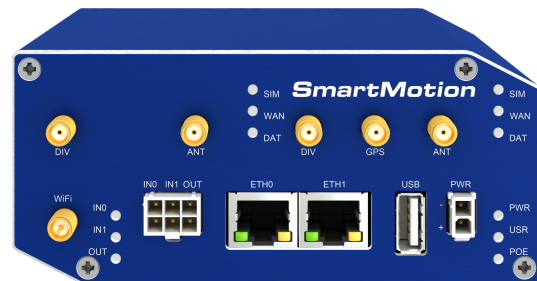
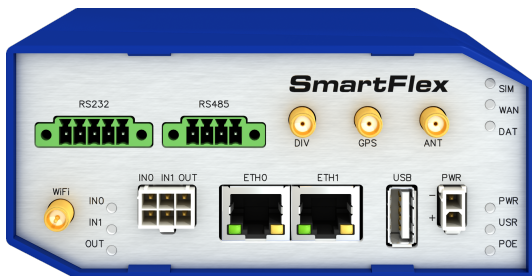

B+B SMARTWORX

Powered by

ADVANTECH



Safety instructions

Please take care to following instructions:

- Use the router in compliance with national and international law and in compliance with any special or additional restrictions regulating use of the router in the various applications and environments.
- To avoid possible injury and/or damage to the device, observe the relevant provisions and standards. Use only the original accessories as recommended. Unauthorized device or accessory modification, or using accessories that have not been approved can result in router damage and/or violation of the regulations.
- Unauthorized device or accessory modification or using the accessories that have not been approved can result in warranty termination.
- Do not open the router.
- **Caution!** The SIM card can be swallowed by small children.
- When connecting the device to a power supply do not exceed the defined voltage.
- Do not expose the router to extreme ambient conditions. Protect the router against dust, moisture, and high temperature.
- It is recommended that you do not use the router at petrol filling stations. We recommend observing local restrictions concerning the use of radio-based devices while working with explosive material for example, at petrol filling stations, or in chemical plants.
- While using the router close to personal medical devices, such as cardiac pacemakers or hearing aids, proceed with heightened caution.
- Operating the router too close to TV sets, radio receivers, personal computers, or telephones can cause interference.
- It is recommended that you create a copy or backup of the important settings stored in the memory of the router.



Product Disposal Instructions

The WEEE (Waste Electrical and Electronic Equipment: 2002/96/EC) directive has been introduced to ensure that electrical/electronic products are recycled using the best available recovery techniques to minimize the impact on the environment. This product contains high quality materials and components which can be recycled. At the end of its life this product **MUST NOT** be mixed with other commercial waste for disposal. Check with the terms and conditions of your supplier for disposal information.



Open Source Software License

The software in this device uses various pieces of open source software governed by following licenses:

- GPL versions 2 and 3
- LGPL version 2
- BSD-style licences
- MIT-style licences

The list of components together with complete license texts can be found on the device itself. See *Licenses* link at the bottom of the router's main Web page (*General Status*) or point your browser to this address (replace the DEVICE_IP string with real router's IP address):

https://DEVICE_IP/licenses.cgi

This is a written offer valid for 3 years since the device purchase offering any third party for a charge no more than cost of physically performing source distribution, a complete machine-readable copy of the corresponding source code on a flash drive medium. If you are interested in obtaining the source, please contact us at:

cellularsales@advantech-bb.com

Modifications and debugging of LGPL-linked executables:

The manufacturer of the device hereby grants the right to use debugging techniques (e.g. decompilation) and making customer modifications of any executable linked with a LGPL library for own purposes. Note these rights are limited to the customer's own usage. No further distribution of such modified executables and no transmission of the information obtained during these actions may be done.

SmartStart Router

SL302, SL304



First Use

Before applying power to the router, connect the components that you required for your applications. You cannot operate the router without connected antenna, inserted SIM card, nor connected power supply.



If you do not have connected main antenna during operation of the router, the router can be damaged!

1. Antenna

Use a SMA connector to connect the antennas to the router. The main antenna is connected to the router by screwing on the *ANT* connector (see the figure below). A second diversity antenna can also be connected to the *DIV* connector to improve performance.



2. SIM card

The SIM card readers, for 3 V and 1.8 V SIM cards, are located on the rear panel of the router. If you intend to use this device to communicate over a cellular network, please place an activated data-provisioned SIM card with an unblocked PIN into the SIM card reader. Push your SIM card into the *SIM1* (or *SIM2* in case of the SmartStart router **SL302** or **SL304**) slot until it clicks in place.



Before handling of the SIM card disconnect the router from power supply!

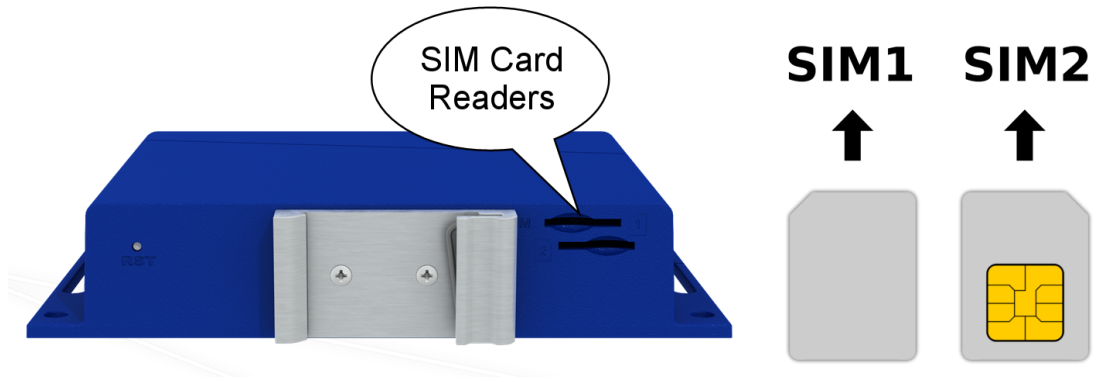

3. Power

The router requires an external DC power supply. The DC voltage required is between +9 to +36 V DC. The router has built-in protection against reverse polarity without signaling. Connect the power supply cable to the *PWR* connector on the front panel of the router (see figure below).

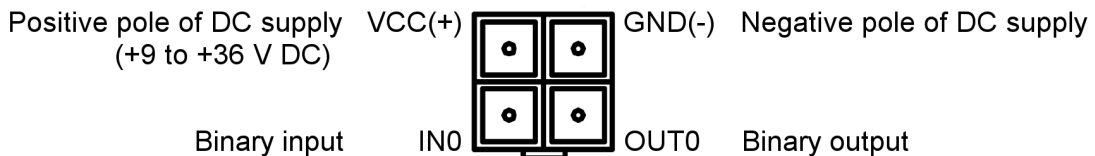
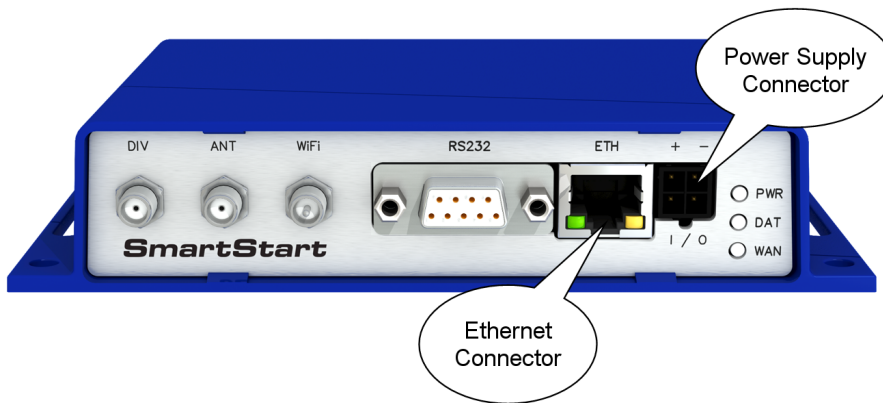

4. Ethernet

An Ethernet cable may be connected to the *ETH* connector (designated as *ETH0* in some versions of this router) on the front panel (see figure above). By default, the Ethernet port is configured as follows:

Connector	Purpose	Default Setting
ETH	LAN port (default) Connect your laptop or PC to this port to get a local web-server for device configuration and diagnostics.	DHCP Server IP Address: 192.168.1.1 NetMask: 255.255.255.0

Configuration

1. Configuring the Device Using the Web Browser

You can access the router for status monitoring, configuration, and administration after entering the IP address of the router into the web interface. The default router IP address is 192.168.1.1 (netmask 255.255.255.0). Configuration access is allowed for the user "root" with the initial password "root". **Attention, it is necessary to use HTTPS protocol for secure communication over a network!** For a detailed description and examples of the router configurations, see the Configuration manual.

2. Configuration Settings via SmartWorx Hub

If your router has been pre-installed with the SmartWorx Hub client, you may configure it from SmartWorx Hub. Navigate your browser to:

<https://hub.bb-smartworx.com>

If this is your first time, please register with the site. If not, please login with your username and password. Once logged in, further assistance can be found here:

https://hub.bb-smartworx.com/Login/Help?HelpFile=bbdms_help.pdf

3. Restoring and Backing up the Router Configuration

After you reset the router, the current configuration is overwritten by the default settings. We recommend that you back up the router configuration before resetting the device. Refer to the Configuration manual for more information.

When the *PWR* LED starts blinking, it is possible to restore the default configuration of the router by pressing the *RST* button on the rear panel. After pressing this button, the default configuration is restored and then the router reboots (green LED will be on).



After logging on to the device for the first time, we strongly recommend to change the default password due to security reasons. Simultaneously, you will gain access to all functions of the router.

Documentation

User's Manual and Configuration Manual for the router can be found on the company web site www.bb-smartcellular.eu/download. Please, use the following login information:

Username: smartrouters

Password: smartrouters



We declare that the SmartStart router **SL304** is in compliance with the essential requirements and other relevant provisions of direction **1995/5/EC**.

The Declaration of Conformity is available on the company website or from technical support, on request.

SmartFlex Router

SR300, SR303, SR305, SR306, SR307

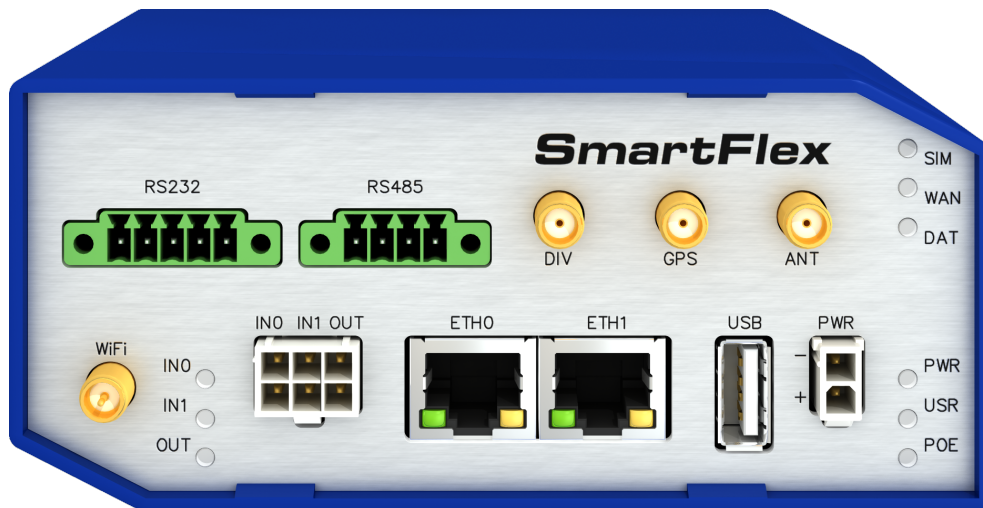

First Use

Before applying power to the router, connect the components that you required for your applications. You cannot operate the router without connected antenna, inserted SIM card, nor connected power supply.



If you do not have connected main antenna during operation of the router, the router can be damaged!



SmartFlex SR300 routers are not equipped with a GSM module which means that SIM card readers and antenna connectors are not available on the router.

1. Antenna

Use a SMA connector to connect the antennas to the router. The main antenna is connected to the router by screwing on the *ANT* connector (see the figure below). A second diversity antenna can also be connected to the *DIV* connector to improve performance.

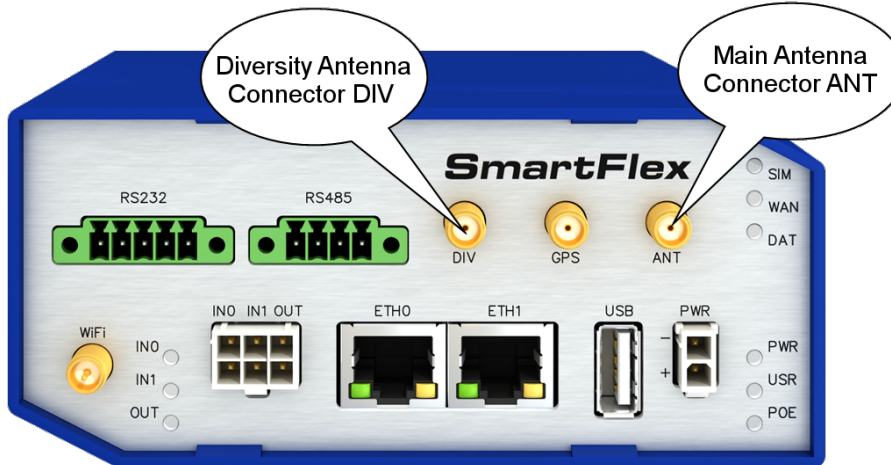

2. SIM card

The SIM card readers, for 3 V and 1.8 V SIM cards, are located on the rear panel of the router. If you intend to use this device to communicate over a cellular network, please place an activated data-provisioned SIM card with an unblocked PIN into the SIM card reader. Push your SIM card into the *SIM1* or *SIM2* slot until it clicks in place.



Before handling of the SIM card disconnect the router from power supply!

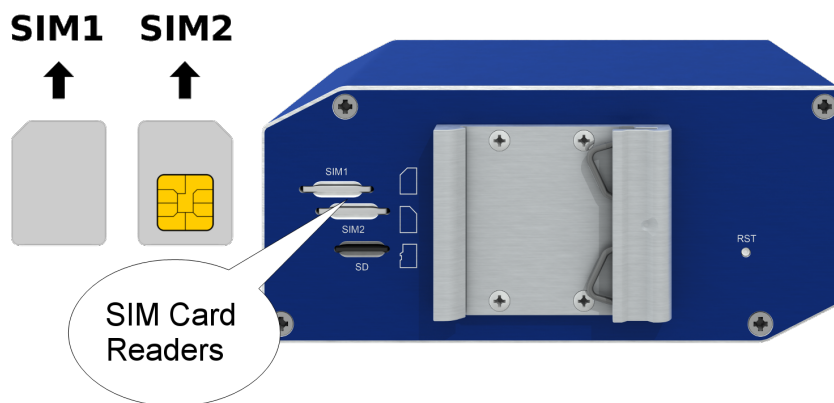

3. Power

The router requires an external DC power supply. The DC voltage required is between +10 to +60 V DC. The router has built-in protection against reverse polarity without signaling. Connect the power supply cable to the *PWR* connector on the front panel of the router (see figure below).

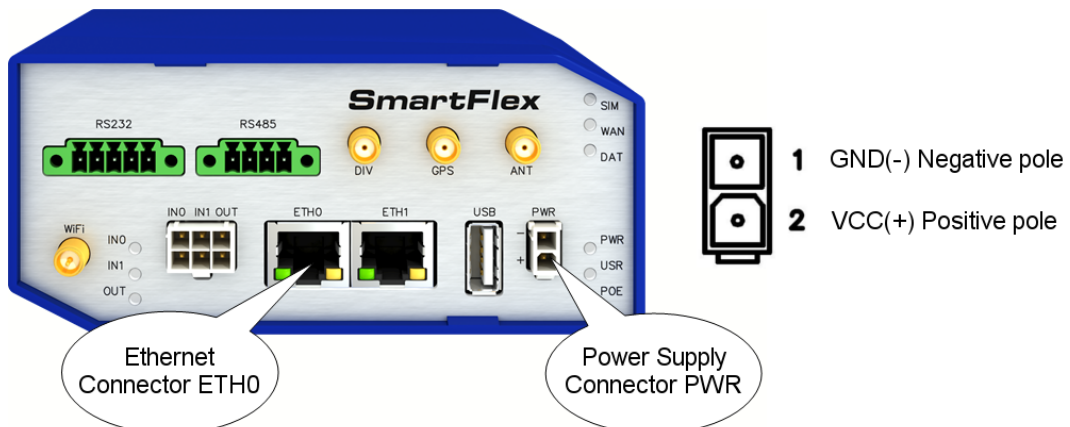

4. Ethernet

An Ethernet cable may be connected to the *ETH0* connector on the front panel (see figure above). By default, this Ethernet port is configured as follows:

Connector	Purpose	Default Setting
ETH0	LAN port (default) Connect your laptop or PC to this port to get a local web-server for device configuration and diagnostics.	DHCP Server IP Address: 192.168.1.1 NetMask: 255.255.255.0

Configuration

1. Configuring the Device Using the Web Browser

You can access the router for status monitoring, configuration, and administration after entering the IP address of the router into the web interface. The default IP address is 192.168.1.1 (netmask 255.255.255.0). Configuration access is allowed for the user "root" with the initial password "root". **Attention, it is necessary to use HTTPS protocol for secure communication over a network!** For a detailed description and examples of the router configurations, see the Configuration manual.

2. Configuration Settings via SmartWorx Hub

If your router has been pre-installed with the SmartWorx Hub client, you may configure it from SmartWorx Hub. Navigate your browser to:

<https://hub.bb-smartworx.com>

If this is your first time, please register with the site. If not, please login with your username and password. Once logged in, further assistance can be found here:

https://hub.bb-smartworx.com/Login/Help?HelpFile=bbdms_help.pdf

3. Restoring and Backing up the Router Configuration

After you reset the router, the current configuration is overwritten by the default settings. We recommend that you back up the router configuration before resetting the device. Refer to the Configuration manual for more information.

When the *PWR* LED starts blinking, it is possible to restore the default configuration of the router by pressing the *RST* button on the rear panel. After pressing this button, the default configuration is restored and then the router reboots (green LED will be on).



After logging on to the device for the first time, we strongly recommend to change the default password due to security reasons. Simultaneously, you will gain access to all functions of the router.

Documentation

User Manual and Configuration Manual for the router can be found on the company web site www.bb-smartcellular.eu/download. Please, use the following login information:

Username: smartrouters

Password: smartrouters

CE We declare that the SmartFlex **SR300** (versions with WiFi only), **SR303**, **SR305**, **SR306** and **SR307** are in compliance with the essential requirements and other relevant provisions of direction **1995/5/EC**.

SmartFlex SR300 versions without WiFi are in compliance with the essential requirements and other relevant provisions of directions **2014/30/EU** and **2014/35/EU**.

The Declaration of Conformity is available on the company website or from technical support, on request.

SmartMotion Router

ST352, ST355

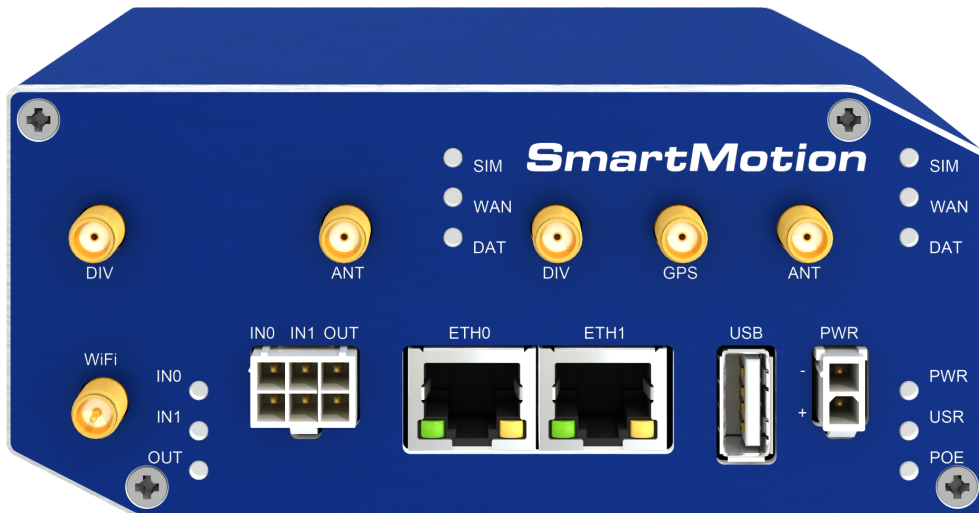

First Use

Before applying power to the router, connect the components that you required for your applications. You cannot operate the router without connected antenna, inserted SIM card, nor connected power supply.



If you do not have connected main antenna during operation of the router, the router can be damaged!

1. Antenna

Use a SMA connector to connect the antennas to the router. The main antenna is connected to the router by screwing on the *ANT* connector (see the figure below). A second diversity antenna can also be connected to the *DIV* connector to improve performance. Three antenna connectors on the right side of the front panel (*ANT*, *DIV* and *GPS*) are intended for connecting the antennas to the first module. There are also two antenna connectors for the second module on the left side (*ANT* and *DIV*).

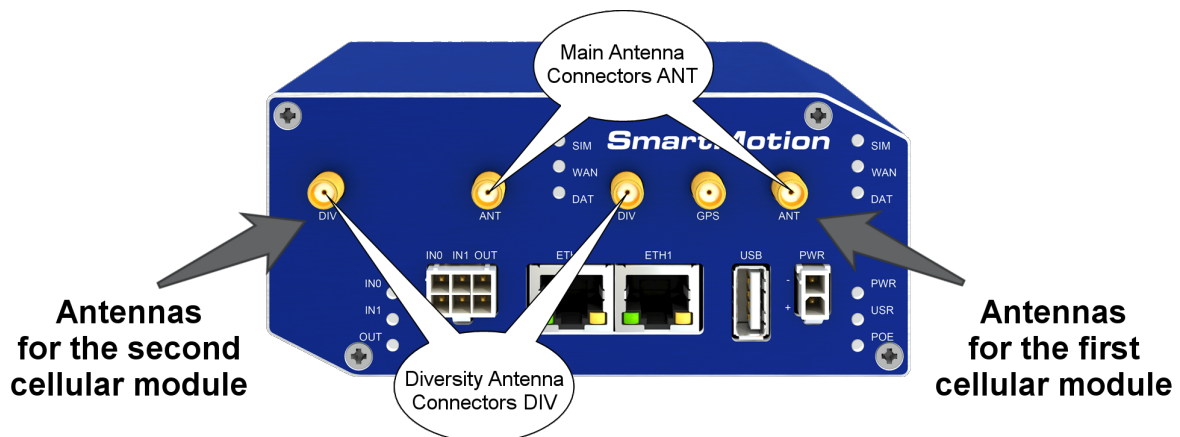

2. SIM card

The SIM card readers, for 3 V and 1.8 V SIM cards, are located on the rear panel of the router. If you intend to use this device to communicate over a cellular network, please place an activated data-provisioned SIM card with an unblocked PIN into the SIM card reader. Push your SIM card into the *SIM1*, *SIM2*, *SIM3* or *SIM4* slot until it clicks in place.



Before handling of the SIM card disconnect the router from power supply!



3. Power

The router requires an external DC power supply. The DC voltage required is between +10 to +60 V DC. The router has built-in protection against reverse polarity without signaling. Connect the power supply cable to the *PWR* connector on the front panel of the router (see figure below).

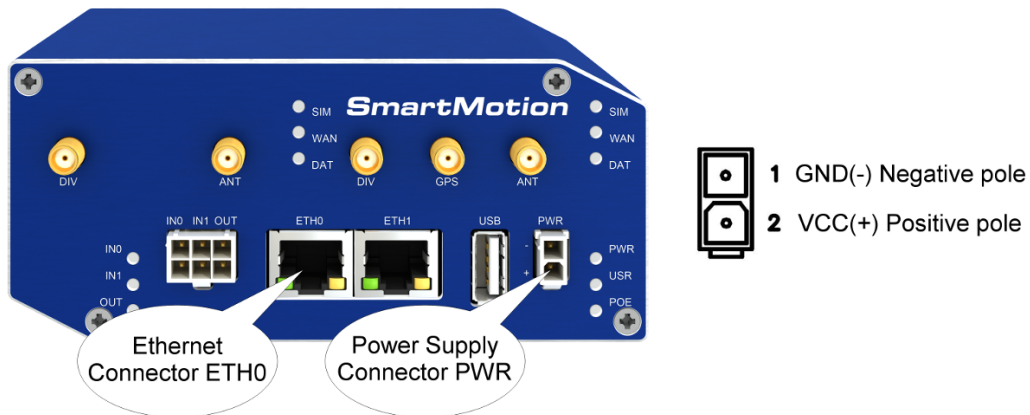

4. Ethernet

An Ethernet cable may be connected to the *ETH0* connector on the front panel (see figure above). By default, this Ethernet port is configured as follows:

Connector	Purpose	Default Setting
ETH0	LAN port (default)	DHCP Server
	Connect your laptop or PC to this port to get a local web-server for device configuration and diagnostics.	IP Address: 192.168.1.1 NetMask: 255.255.255.0