

# LTE Industrial Router

# SmartFlex SR306

## USER MANUAL

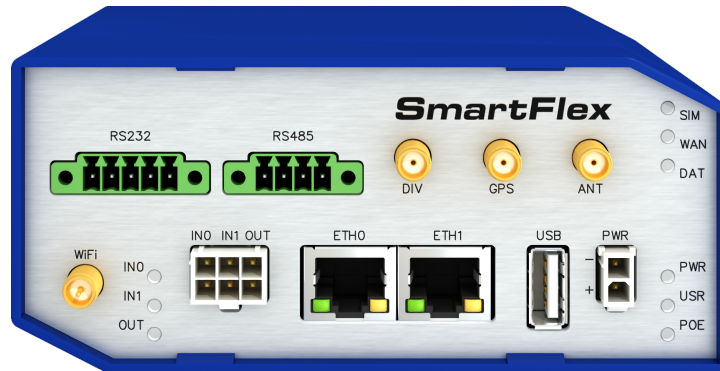
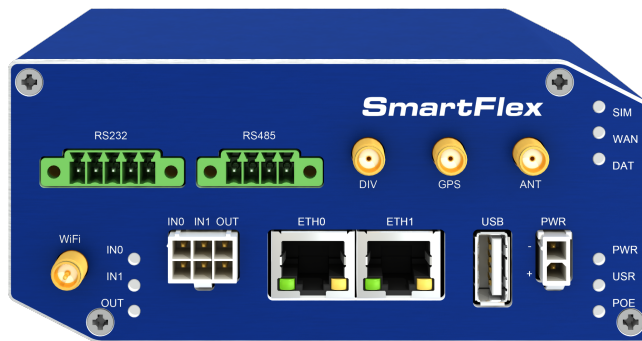

**B+B SMARTWORX**

Powered by

**ADVANTECH**

## **Advantech B+B SmartWorx – Americas**

**Advantech B+B SmartWorx**

707 Dayton Road  
Ottawa, IL 61350 USA

**Phone** +1 (815) 433-5100

**Fax** +1 (815) 433-5105

**Website**

[www.advantech-bb.com](http://www.advantech-bb.com)

## **Advantech B+B SmartWorx – Europe**

**Advantech B+B SmartWorx s.r.o.**

Sokolska 71  
562 04, Usti nad Orlici,  
Czech Republic

**Phone** +420 465 524 421

**Website**

[www.advantech-bb.com](http://www.advantech-bb.com)

© 2016 Advantech B+B SmartWorx s.r.o. No part of this publication may be reproduced or transmitted in any form or by any means, electronic or mechanical, including photography, recording, or any information storage and retrieval system without written consent. Information in this manual is subject to change without notice, and does not represent a commitment on the part of Advantech B+B SmartWorx.

Advantech B+B SmartWorx s.r.o. shall not be liable for incidental or consequential damages resulting from the furnishing, performance, or use of this manual.

All brand names used in this manual are the registered trademarks of their respective owners. The use of trademarks or other designations in this publication is for reference purposes only and does not constitute an endorsement by the trademark holder.

## Used symbols



*Danger* – Information regarding user safety or potential damage to the router.



*Attention* – Problems that can arise in specific situations.



*Information, notice* – Useful tips or information of special interest.

## GPL licence

Source codes under GPL licence are available free of charge by sending an email to:

[cellularsales@advantech-bb.com](mailto:cellularsales@advantech-bb.com).



# Contents

<b>1</b>	<b>Safety Instructions</b>	<b>3</b>
<b>2</b>	<b>WEEE directive</b>	<b>4</b>
<b>3</b>	<b>Router Description</b>	<b>5</b>
3.1	Usage of the Router . . . . .	6
<b>4</b>	<b>Contents of Package</b>	<b>9</b>
<b>5</b>	<b>Router Design</b>	<b>10</b>
5.1	Router versions . . . . .	10
5.2	Delivery identification . . . . .	12
5.3	Order codes . . . . .	13
5.4	Basic dimensions of the router box . . . . .	15
5.5	Mounting recommendations . . . . .	15
5.6	Removal of the DIN rail . . . . .	16
5.7	Description of the rear panel . . . . .	17
5.8	Description of the front panel . . . . .	17
5.8.1	Status indication . . . . .	18
5.8.2	Power connector PWR . . . . .	19
5.8.3	Antenna connector ANT, DIV, GPS and WiFi . . . . .	20
5.8.4	SIM card reader . . . . .	21
5.8.5	MicroSD card reader . . . . .	21
5.8.6	Ethernet Ports (ETH0 and ETH1) . . . . .	22
5.8.7	Power over Ethernet (PoE) . . . . .	23
5.8.8	USB Port . . . . .	25
5.8.9	I/O Port . . . . .	25
5.8.10	Reset . . . . .	28
5.9	Interfaces Description . . . . .	29
5.9.1	RS232 interface . . . . .	29
5.9.2	RS232-RS485/422 interface . . . . .	31
5.9.3	SWITCH interface . . . . .	33
5.9.4	RS232-RS485-ETH interface . . . . .	34
<b>6</b>	<b>First Use</b>	<b>37</b>
6.1	Connecting the router before first use . . . . .	37
6.2	Start . . . . .	38
6.3	Configuration . . . . .	38
6.3.1	Configuration by web browser . . . . .	38



<b>7</b>	<b>Technical Parameters</b>	<b>40</b>
7.1	Basic parameters . . . . .	40
7.2	Standards and regulations . . . . .	41
7.3	Type tests and environmental conditions . . . . .	42
7.4	Technical parameters of cellular module . . . . .	43
7.5	Technical parameters of GPS . . . . .	44
7.6	Technical parameters of WiFi . . . . .	44
7.7	Technical parameters of I/O port . . . . .	45
7.8	Technical Parameters of Power over Ethernet (PoE) . . . . .	45
7.9	Other Technical Parameters . . . . .	46
<b>8</b>	<b>Recommended Literature</b>	<b>47</b>
<b>9</b>	<b>Troubleshooting</b>	<b>48</b>
9.1	FAQ . . . . .	48
<b>10</b>	<b>Customers Support</b>	<b>50</b>
10.1	Customer Support for NAM . . . . .	50
10.2	Customer Support for Europe . . . . .	50
10.3	Customer Support for Asia . . . . .	50

# List of Figures

1	Access to the Internet from LAN	6
2	Backed up access to the Internet	7
3	Using VPN tunnel	7
4	Serial Gateway	8
5	Contents of package	9
6	Basic version (plastic)	10
7	Basic version with WiFi (plastic)	10
8	Basic version (metal)	10
9	Basic version with WiFi (metal)	10
10	Version SWITCH (plastic)	11
11	Version SWITCH and WiFi (plastic)	11
12	Version RS232 (plastic)	11
13	Version RS232-RS485 (plastic)	11
14	Ver. RS232-RS485 & WiFi (plastic)	11
15	Version SWITCH (metal)	11
16	Version SWITCH and WiFi (metal)	11
17	Version RS232 (metal)	11
18	Version RS232-RS485 (metal)	11
19	Version RS232-RS485 & WiFi (metal)	11
20	Version RS232-RS485-ETH (plastic)	12
21	RS232-RS485-ETH & WiFi (plastic)	12
22	Version RS232-RS485-ETH (metal)	12
23	RS232-RS485-ETH & WiFi (metal)	12
24	Label examples	12
25	Basic dimensions of the router box	15
26	Default position of DIN holder	16
27	Removal of the DIN rail	16
28	SmartFlex front panel	17
29	Power connector	19
30	Connection of power supply	19
31	Connecting the antenna	20
32	SIM cards	21
33	MicroSD card	22
34	Ethernet connector	22
35	Connection of Ethernet cable	23
36	PoE PD usage	23
37	PoE PSE usage	24
38	USB connector	25
39	I/O connector	25
40	Binary inputs connection	26

41	Binary output connection . . . . .	27
42	Router reset . . . . .	28
43	Version with RS232 interface . . . . .	29
44	RS232 connector . . . . .	30
45	Meter connection to router . . . . .	30
46	Version with RS232-RS485/422 interface . . . . .	31
47	RS232 connector . . . . .	31
48	RS485/422 connector . . . . .	32
49	Connection of jumpers . . . . .	32
50	Version with SWITCH board . . . . .	33
51	Version with RS232-RS485-ETH interface . . . . .	34
52	Ethernet connector . . . . .	35
53	RS485 connector . . . . .	35
54	RS232 connector . . . . .	35
55	Router connection . . . . .	37
56	Entering the IP address of the router . . . . .	38
57	Entering login information . . . . .	38
58	Router web interface . . . . .	39

# List of Tables

1	Router versions . . . . .	10
2	Delivery identification . . . . .	12
3	Order codes overview . . . . .	13
4	Power over Ethernet . . . . .	13
5	Type of router box . . . . .	14
6	Type of power supply . . . . .	14
7	Examples of order code . . . . .	14
8	Front panel description . . . . .	17
9	Status indication . . . . .	18
10	Connection of power connector . . . . .	19
11	Technical specifications of microSD card . . . . .	21
12	Connection of Ethernet connector . . . . .	22
13	Insulation strength of Ethernet ports . . . . .	23
14	Connection of USB connector . . . . .	25
15	Connection of I/O port . . . . .	25
16	Characteristics of inputs . . . . .	26
17	Description of router reset and restart . . . . .	28
18	Connection of RS232 connector . . . . .	29
19	State indication of RS232 interface . . . . .	30
20	RS232 interface technical specification . . . . .	30
21	Connection of RS232 connector . . . . .	31
22	Connection of RS485 connector . . . . .	31
23	Connection of RS422 connector . . . . .	32
24	Technical specification of RS232 and RS485 . . . . .	33
25	State indication of the SWITCH interface . . . . .	33
26	SWITCH interface parameters . . . . .	34
27	Connections of the Ethernet Connector . . . . .	34
28	Connections of Terminal Block Connector RS485 . . . . .	35
29	Connections of Terminal Block Connector RS232 . . . . .	35
30	State indication of the RS232-RS485-ETH interface . . . . .	36
31	Technical specification of RS232, RS485 and Ethernet . . . . .	36
32	Basic parameters . . . . .	40
33	Standards and regulations . . . . .	41
34	Type tests and environmental conditions . . . . .	42
35	Technical parameters of cellular module . . . . .	43
36	Technical parameters of GPS . . . . .	44
37	Technical parameters of WiFi . . . . .	44
38	Characteristics of inputs . . . . .	45
39	PoE PD: parameters for opposite PSE . . . . .	45
40	PoE PSE parameters . . . . .	45

41 Other technical parameters . . . . . 46

# 1. Safety Instructions



**Please, observe the following instructions:**

- The router must be used in compliance with all applicable international and national laws and in compliance with any special restrictions regulating the utilization of the router in prescribed applications and environments.
- To prevent possible injury and damage to appliances and to ensure compliance with all relevant provisions, use only the original accessories. Unauthorized modifications or the use of unapproved accessories may result in damage to the router and/or a breach of applicable regulations. Unauthorized modifications or use of unapproved accessories may void the warranty.
- The router can not be opened.
- Turn off the router and disconnect it from power supply before handling the SIM card.
- **Caution!** The SIM card could be swallowed by small children.
- Power supply must not exceed 60 V DC max.
- Do not expose the router to extreme ambient conditions. Protect the router against dust, moisture and high temperature.
- The router should not be used in locations where flammable and explosive materials are present, including gas stations, chemical plants, or locations in which explosives are used. We remind users of the duty to observe the restrictions concerning the utilization of radio devices at such places.
- Switch off the router when travelling by plane. Utilization of the router on a plane may endanger the operation of the plane or interfere with the mobile telephone network, and may be unlawful. Failure to observe these instructions may result in the suspension or cancellation of telephone services for the respective client and/or may result in legal sanctions.
- When using the router in close proximity to personal medical devices, such as cardiac pacemakers or hearing aids, you must proceed with heightened caution.
- The router may cause interference when used in close proximity to TV sets, radio receivers or personal computers.
- It is recommended that you create an appropriate copy or backup of all important settings that are stored in the memory of the device.



## 2. Product Disposal Instructions

The WEEE (Waste Electrical and Electronic Equipment: 2002/96/EC) directive was introduced to ensure that electrical/electronic products are recycled using the best available recovery techniques in order to minimize impact on the environment. This product contains high quality materials and components which can be recycled. At the end of its life this product **MUST NOT** be mixed with other commercial waste for disposal. Check the terms and conditions of your supplier for disposal information.

## 3. Router Description

SmartFlex SR306 is an industrial cellular router intended for the Latin American (LATAM) and Asia Pacific (APAC) markets. However, it can also be operated in Europe, Middle East and Africa (EMEA) area. This router is an ideal device for wireless communication in mobile networks that make use of LTE, HSPA+, UMTS, EDGE or GPRS technology. Due to the high speed of data transfer up to 100 Mbit/s (download) and up to 50 Mbit/s (upload) is this router an ideal solution for specialized M2M devices and IoT as well as for wireless connection of traffic and security camera systems, individual computers, LAN networks, automatic teller machines (ATM) and other self-service terminals.

The standard configuration includes two Ethernet 10/100 ports, one USB 2.0 Host port, two binary inputs and one output (I/O connector). The device also has two readers for 3 V and 1.8 V SIM cards, which are located on the rear panel of the router. The router also includes a microSD card port that supports up to 64 GB card storage (32 GB in the case of SDHC cards). The router can be equipped with a WiFi module, but this must be part of the initial configuration – it cannot be added to the router at some point in the future.

The router can be equipped with PoE PD (Power over Ethernet – Powered Device), which allows the router to be powered via Ethernet. It can also be equipped with PoE PSE (Power over Ethernet – Power Source Equipment), which lets the router power other devices via Ethernet. The SmartFlex can also be configured with a wide variety of port options. These can be SWITCH – three switched Ethernet ports; RS232 – serial interface; RS232-RS485/422 – combination of serial interfaces; RS232-RS485-ETH – combination of serial interfaces and Ethernet port with higher insulation. The router can be provided in either a plastic or metal casing, depending upon the customer's requirements.

Configuration of the router may be done via a password-protected Web interface. Web interface provides detailed statistics about the router's activities, signal strength, detailed system log etc. The router supports the creation of VPN tunnels using IPsec, OpenVPN and L2TP to ensure safe communication. DHCP, NAT, NAT-T, DynDNS, NTP, VRRP, control by SMS, backup primary connection and many other functions are supported.

The router provides diagnostic functions which include automatically monitoring the PPP connection, automatic restart in case of connection losses, and a hardware watchdog that monitors the router status. The user may insert Linux scripts which are started on various actions. It is possible to create up to four different configurations for the same router. These configurations can be switched whenever necessary via Web interface, SMS or binary input status. The router can automatically upgrade its configuration and firmware from your central server. This allows for mass reconfiguration of numerous routers at the same time.

The router also supports additional software like R-SeeNet for permanent traffic monitoring of routers.





**Examples of possible applications**

- mobile office
- fleet management
- security system
- telematic
- telemetric
- remote monitoring
- vending and dispatcher machines

**3.1 Usage of the Router**

The router is primarily intended for these four basic situations:

**I. Access to the Internet from LAN**

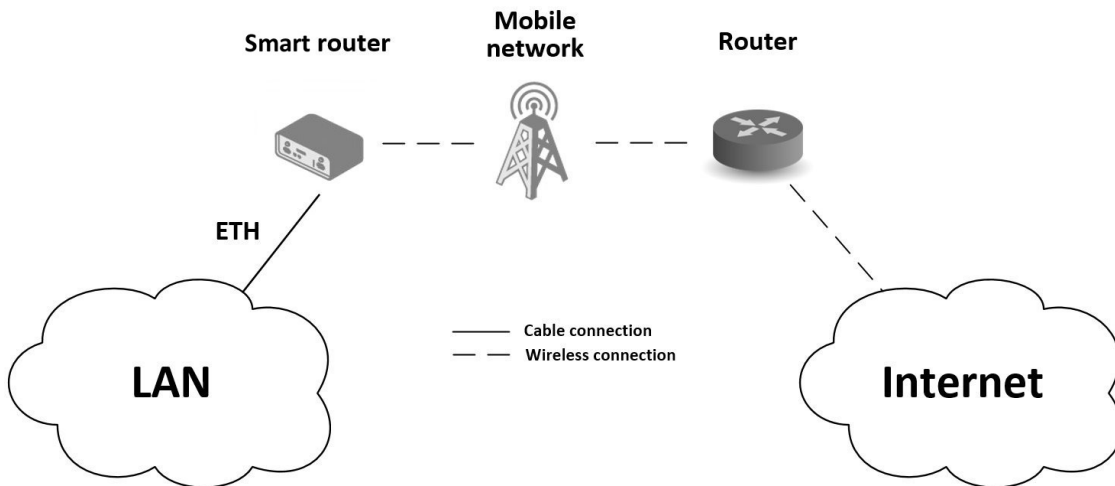

Figure 1: Access to the Internet from LAN

### II. Backed up access to the Internet (from LAN)

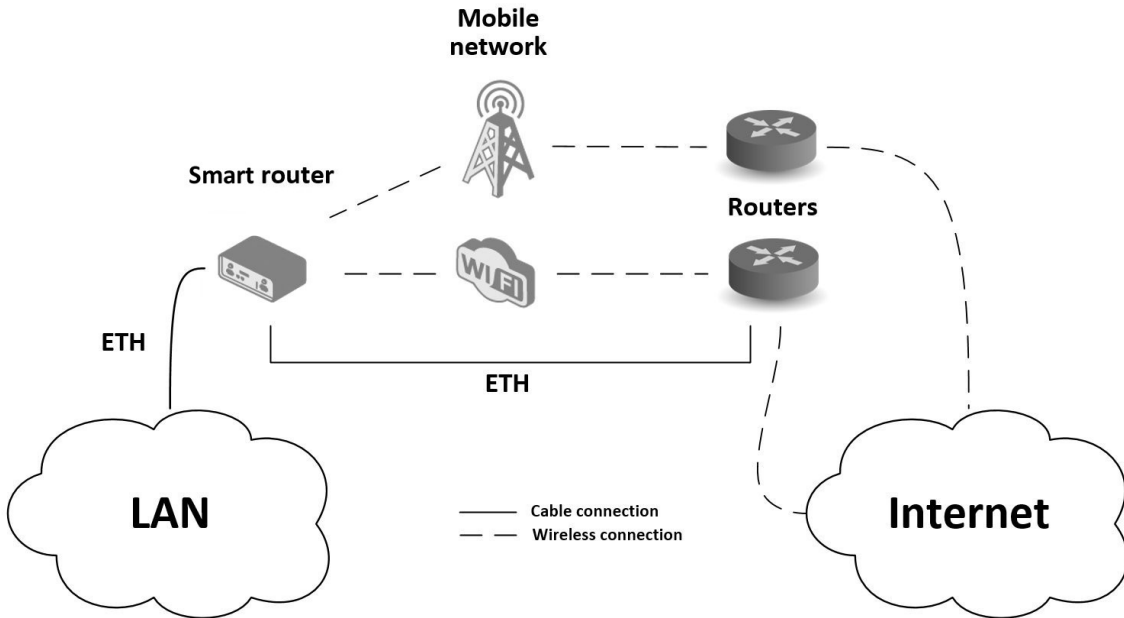

Figure 2: Backed up access to the Internet

### III. Secure networks interconnection or using VPN

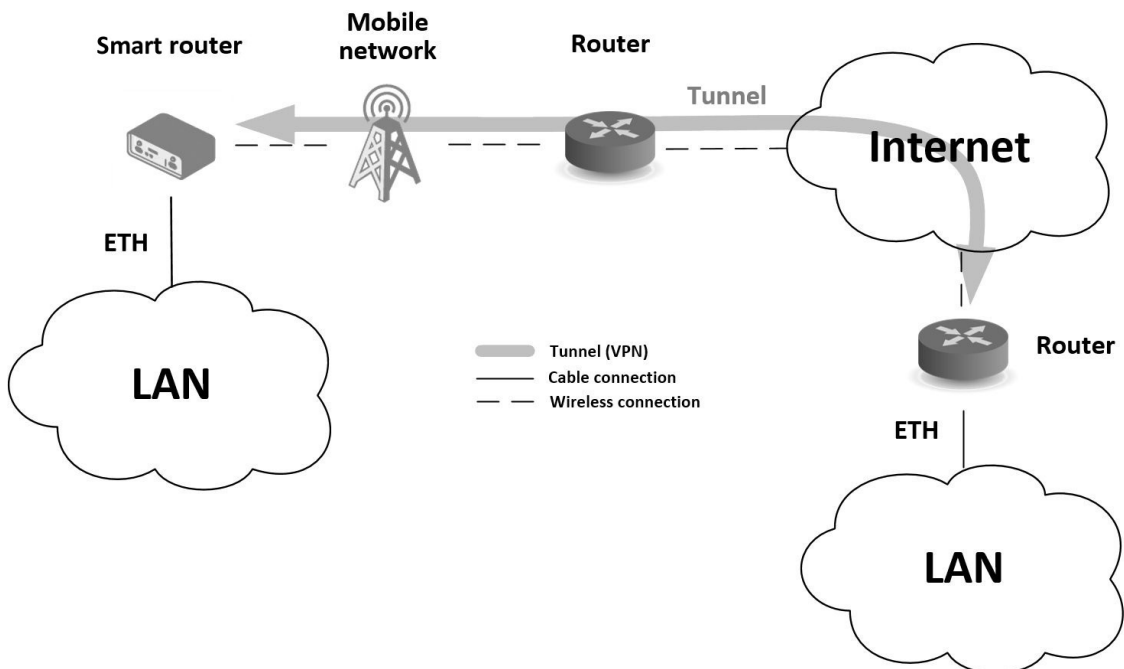

Figure 3: Using VPN tunnel

#### IV. Serial Gateway

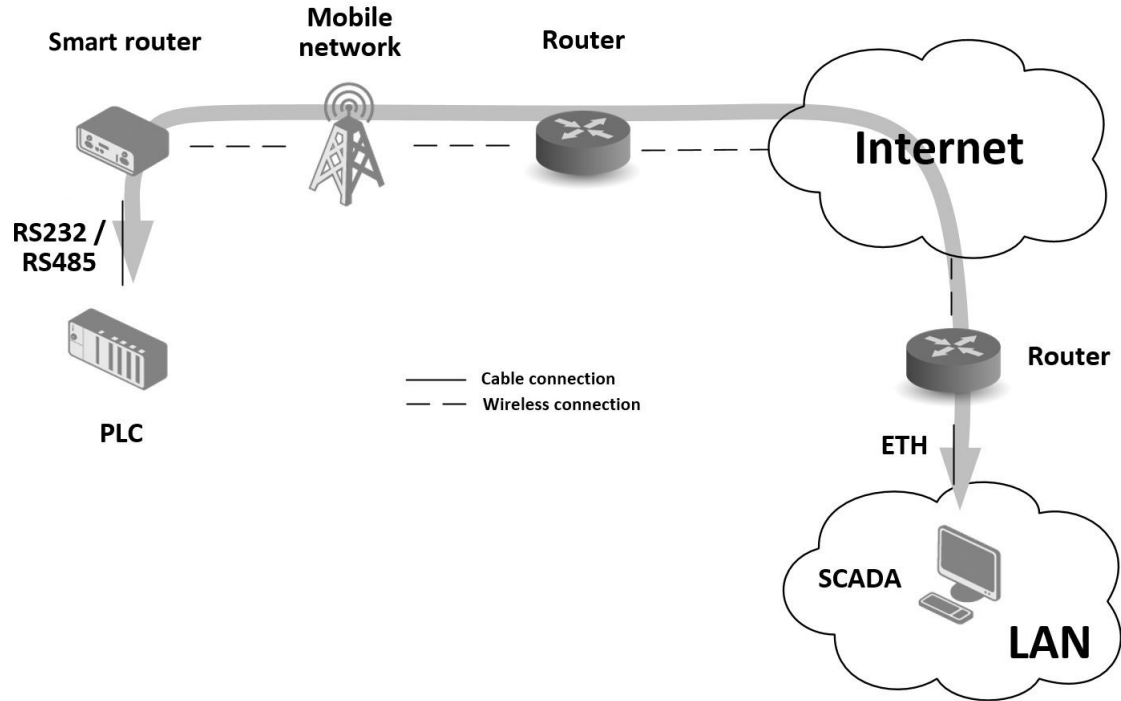

Figure 4: Serial Gateway

## 4. Contents of Package



Basic delivered set of router includes:

- router,
- power supply,
- crossover UTP cable,
- up to three external antennas,
- loose power and I/O connector (+8 pins<sup>1</sup>),
- 4-pins and 5-pins terminal block for RS485 and RS232 (**only for version with interface RS232-RS485/422**),
- 3-pins and 4-pins terminal block for RS485 and RS232 (**only for version with interface RS232-RS485-ETH**),
- clip for the DIN rail,
- paper start guide.

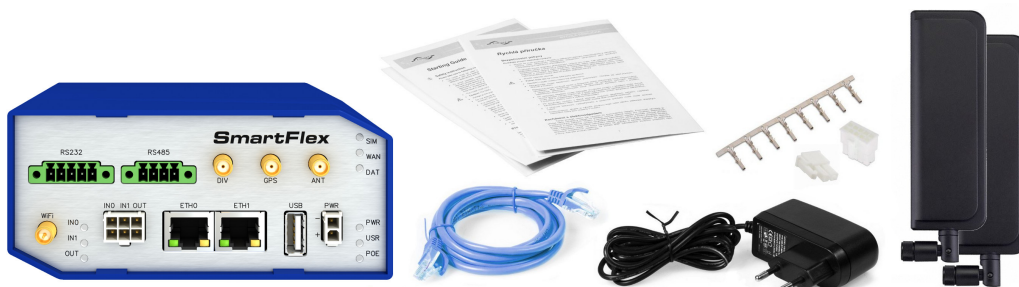

Figure 5: Contents of package



Temperature range for power supply is reduced to 0 °C to +40 °C!

<sup>1</sup>These pins are designed for cables with a diameter from 0.2 to 0.8 mm<sup>2</sup>

# 5. Router Design

## 5.1 Router versions

SmartFlex SR306 router is supplied in the following versions (see table below). All versions are available in plastic or metal box according to customer requirements. All versions are available with PoE PD (Power over Ethernet – powered device) so you can power the router from both ETH0 and ETH1 interfaces, or with PoE PSE (power source equipment) so you can power other devices by the router.

Router versions	SIM	BIN	BOUT	USB	SD	ETH	WiFi	232	485
Basic version	2x	2x	1x	1x	1x	2x			
Basic version with WiFi	2x	2x	1x	1x	1x	2x	1x		
Version with SWITCH board	2x	2x	1x	1x	1x	5x			
Version with SWITCH board & WiFi	2x	2x	1x	1x	1x	5x	1x		
Version with RS232 board	2x	2x	1x	1x	1x	2x		1x	
Version with RS232-RS485/422 board	2x	2x	1x	1x	1x	2x		1x	1x
Version with RS232-RS485/422 & WiFi	2x	2x	1x	1x	1x	2x	1x	1x	1x
Version with RS232-RS485-ETH board	2x	2x	1x	1x	1x	3x		1x	1x
Version with RS232-RS485-ETH & WiFi	2x	2x	1x	1x	1x	3x	1x	1x	1x

Table 1: Router versions

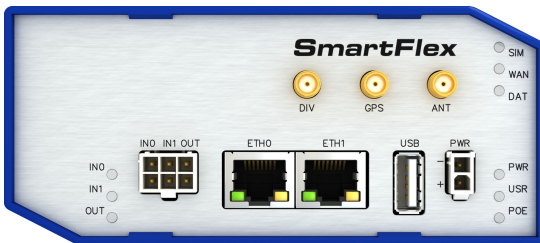

Figure 6: Basic version (plastic)

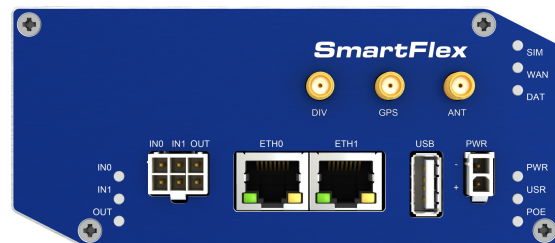

Figure 8: Basic version (metal)

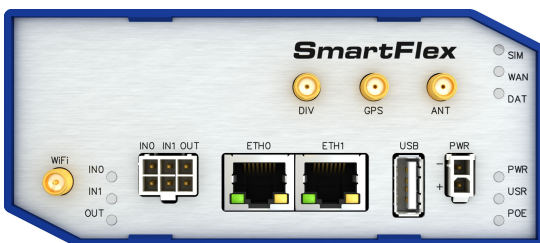

Figure 7: Basic version with WiFi (plastic)



Figure 9: Basic version with WiFi (metal)

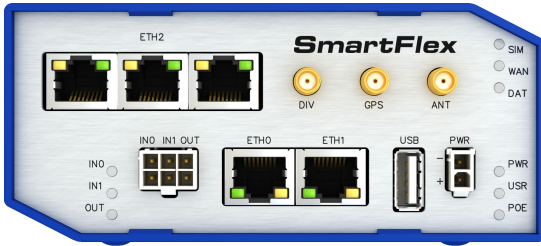

Figure 10: Version SWITCH (plastic)

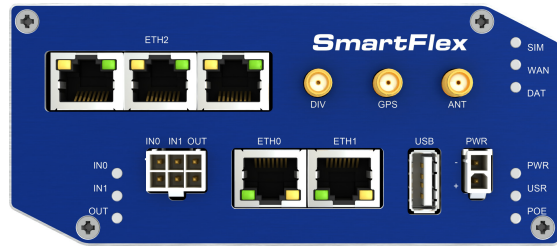

Figure 15: Version SWITCH (metal)

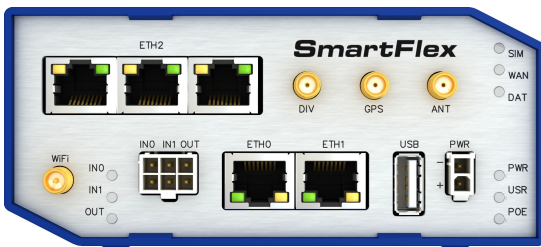

Figure 11: Version SWITCH and WiFi (plastic)

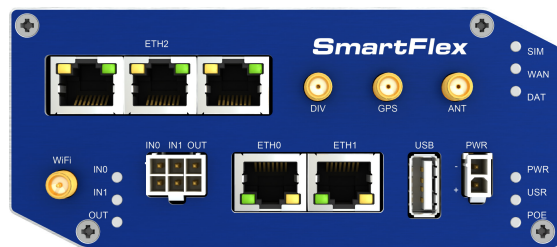

Figure 16: Version SWITCH and WiFi (metal)

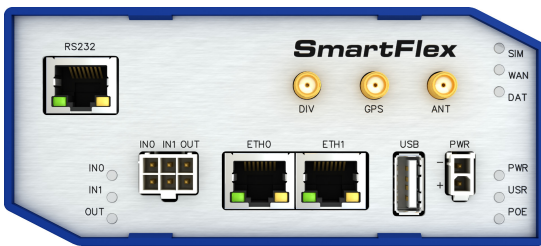

Figure 12: Version RS232 (plastic)

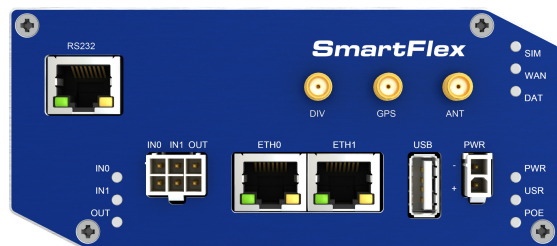

Figure 17: Version RS232 (metal)

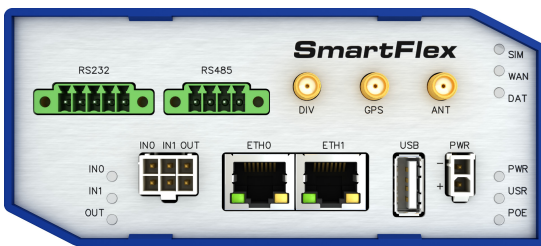

Figure 13: Version RS232-RS485 (plastic)

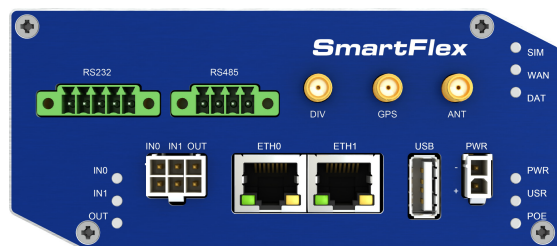

Figure 18: Version RS232-RS485 (metal)

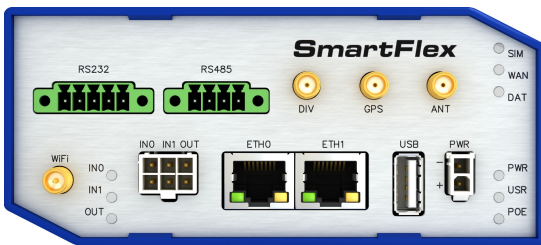

Figure 14: Ver. RS232-RS485 & WiFi (plastic)

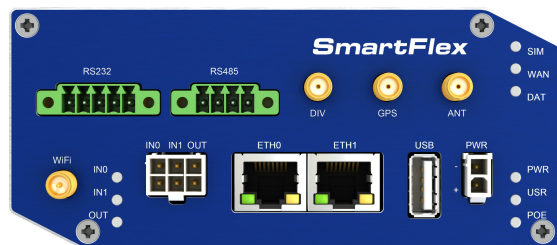

Figure 19: Version RS232-RS485 & WiFi (metal)



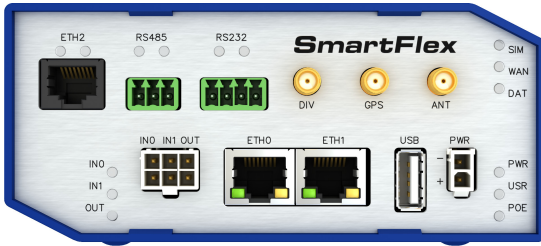

Figure 20: Version RS232-RS485-ETH (plastic)

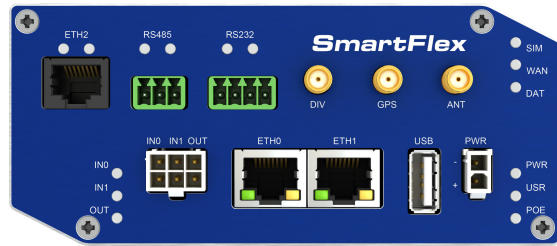

Figure 22: Version RS232-RS485-ETH (metal)

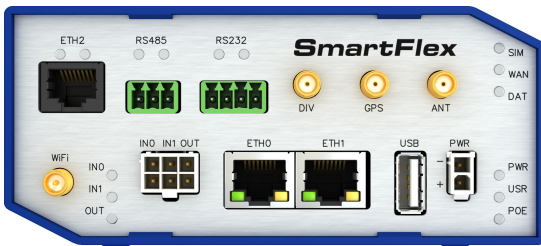

Figure 21: RS232-RS485-ETH & WiFi (plastic)

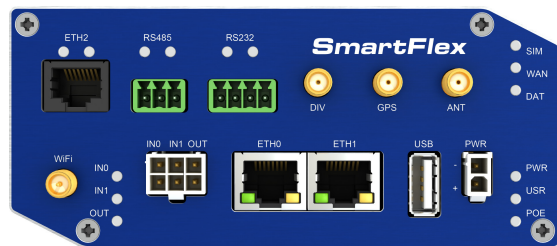

Figure 23: RS232-RS485-ETH & WiFi (metal)

## 5.2 Delivery identification

Trade name	Type name	Other
SmartFlex SR306	SmartFlex	Router in a plastic or metal box

Table 2: Delivery identification

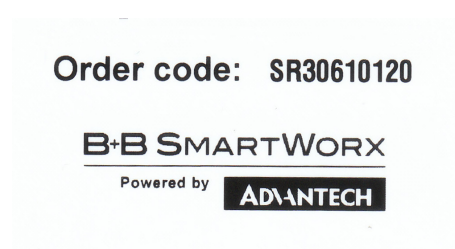

Figure 24: Label examples

### 5.3 Order codes

Order codes overview is shown in the table below.

Product Name	Order code	Features – interfaces
SR306	SR3060x0yz*	LTE module, 2x ETH, 1x USB, 2x BI, 1x BO, 1x microSD reader, 2x SIM reader
SR306	SR3061x0yz*	LTE module, 2x ETH, 1x USB, 2x BI, 1x BO, 1x microSD reader, 2x SIM reader, WiFi
SR306	SR3060x1yz*	LTE module, 5x ETH, 1x USB, 2x BI, 1x BO, 1x microSD reader, 2x SIM reader
SR306	SR3061x1yz*	LTE module, 5x ETH, 1x USB, 2x BI, 1x BO, 1x microSD reader, 2x SIM reader, WiFi
SR306	SR3060x2yz*	LTE module, 2x ETH, 1x USB, 2x BI, 1x BO, 1x microSD reader, 2x SIM reader, RS232
SR306	SR3060x3yz*	LTE module, 2x ETH, 1x USB, 2x BI, 1x BO, 1x microSD reader, 2x SIM reader, RS232, RS485
SR306	SR3061x3yz*	LTE module, 2x ETH, 1x USB, 2x BI, 1x BO, 1x microSD reader, 2x SIM reader, WiFi, RS232, RS485
SR306	SR3060x4yz*	LTE module, 3x ETH, 1x USB, 2x BI, 1x BO, 1x microSD reader, 2x SIM reader, RS232, RS485
SR306	SR3061x4yz*	LTE module, 3x ETH, 1x USB, 2x BI, 1x BO, 1x microSD reader, 2x SIM reader, WiFi, RS232, RS485

Table 3: Order codes overview



\* Replace the letters "x", "y" and "z" with the values from the following tables:

#### Letter "x" – Power over Ethernet (PoE)

Power over Ethernet (PoE)	Number "x" in code
Version without PoE	0
PoE PSE – Power Source Equipment – powers other devices	8
PoE PD – Powered Device – can be powered via Ethernet	9

Table 4: Power over Ethernet



**Letter "y" – type of the router box**

Type of box	Number "y" in code
Plastic	1
Metal	2

Table 5: Type of router box

**Letter "z" – type of the power supply connector**

Type of power supply	Number "z" in code
Europe	1
UK & Ireland	2
Australia	3
Without accessories	0

Table 6: Type of power supply

Examples of complete order code:

Order code	Features – interfaces	Box	Power supply
SR30608011	LTE module, 2x ETH, 1x USB, 2x BI, 1x BO, 1x microSD reader, 2x SIM reader, PoE PSE	plastic	Australia
SR30609121	LTE module, 5x ETH, 1x USB, 2x BI, 1x BO, 1x microSD reader, 2x SIM reader, PoE PD	metal	Australia
SR30600210	LTE module, 2x ETH, 1x USB, 2x BI, 1x BO, 1x microSD reader, 2x SIM reader, RS232	plastic	None
SR30610320	LTE module, 2x ETH, 1x USB, 2x BI, 1x BO, 1x microSD reader, 2x SIM reader, WiFi, RS232, RS485	metal	None

Table 7: Examples of order code



You can use the order codes configurator on the [www.bb-smartcellular.eu](http://www.bb-smartcellular.eu) web pages.

## 5.4 Basic dimensions of the router box

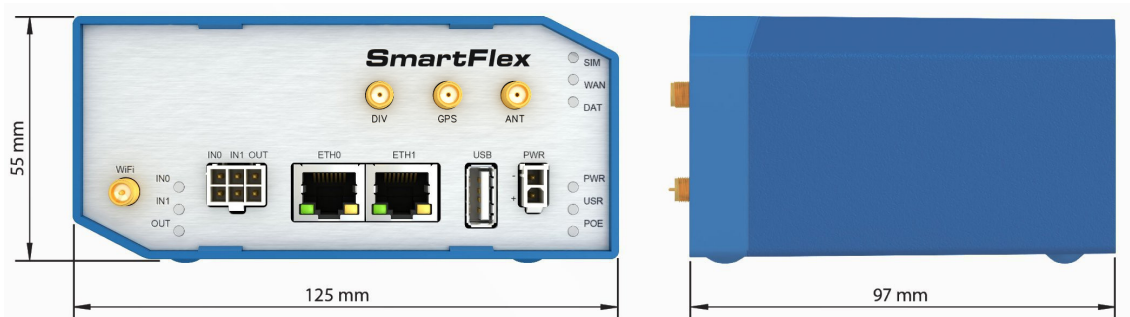

Figure 25: Basic dimensions of the router box

## 5.5 Mounting recommendations

- It is possible to place the router on a flat surface,
- DIN rail EN 60715 with the included plastic or metal clip.

For most applications with a built-in router within a switchboard it is possible to recognize two kinds of environments:

- A non-public, industry environment of low voltage with high interference,
- A public environment of low voltage and without high interference.

For both of these environments it is possible to mount router to a switchboard, after which there is no need to have examination immunity or issues in connection with EMC according to EN 61439-1:2011.



**Attention:** If the negative pole of the router is grounded, there is no protection against reversed polarity!



In compliance with the EN 61439-1:2011 specification it is necessary to observe the following assembly instructions for a router attached to a switchboard:

- For whip antennas it is recommended to observe a minimum distance of 6 cm from cables and metal surfaces on every side in order to avoid interference. When using an external antenna separate from the switchboard it is necessary to fit a lightning conductor.
- When mounting a router on sheet-steel we recommend using a "cable" antenna.
- For all cables we recommend to bind the bunch, and for this we recommend:

- The length of the bunch (combination of power supply and data cables) should be a maximum 1.5 m. If the length of data cables exceeds 1.5 m or if the cable is leading towards the switchboard, we recommend installing surge protectors.
- Data cables must not have a reticular tension of  $\sim 230$  V/50 Hz or  $\sim 120$  V/60 Hz.
- Sufficient space must be left between individual connectors for the handling of cables,
- To ensure correct functioning of the router we recommend the use of an earth-bonding distribution frame for the grounding of the power supply of the router, data cables and antenna within the switchboard.

## 5.6 Removal of the DIN rail

The DIN holder is suitable for a DIN rail according to EN 60715 standard only. The default position of plastic or metal holder, which is used for mounting the router on a DIN rail, is shown in the following figure:

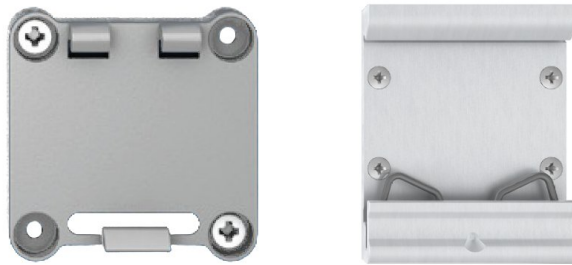

Figure 26: Default position of DIN holder

In order to remove the DIN rail it is necessary to lightly push the router upward so that the top part of the DIN holder hitched to the DIN rail comes out of this rail, then fold the top of the router away from the DIN rail.

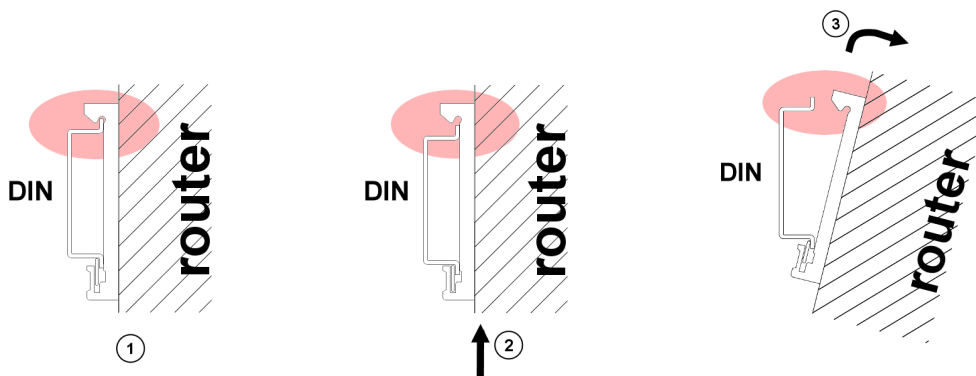

Figure 27: Removal of the DIN rail

## 5.7 Description of the rear panel

The rear panel contains two holders for SIM cards (*SIM1* and *SIM2*), a holder for microSD card (*SD*) and an *RST* button used to restore the default configuration and reboot the router.

## 5.8 Description of the front panel

On the front panel is the following:

Caption	Connector	Description
PWR	2-pin	Connector for the power supply
ETH0	RJ45	Connector for connection into the computer network, PoE (only for PoE PSE or PoE PD versions)
ETH1	RJ45	Connector for connection into the computer network, PoE (only for PoE PSE or PoE PD versions)
ANT	SMA	Connector for main antenna
DIV	SMA	Connector for diversity antenna
GPS	SMA	Connector for GPS antenna
WiFi	R-SMA	Connector for WiFi antenna ( <b>only for versions with WiFi module!</b> )
USB	USB-A 2.0 Host	Connector for connection of USB devices to the router. Supports devices with PL-2303 and FTDI USB/RS232 converters.
I/O	6-pin	Connector for connection of the binary inputs and output

Table 8: Front panel description

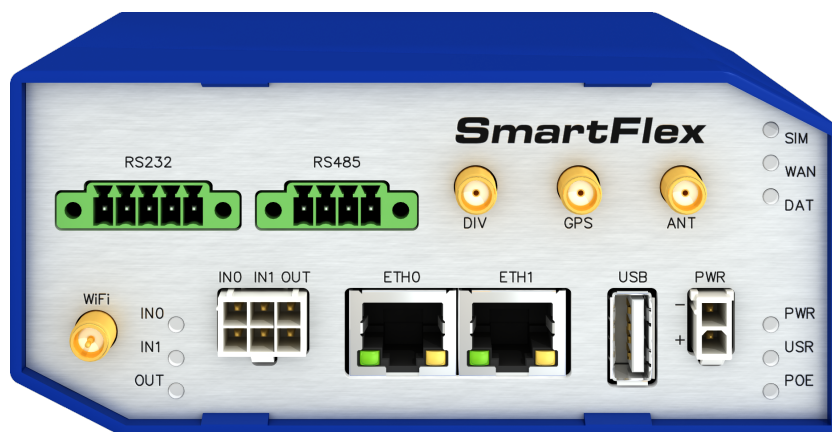

Figure 28: SmartFlex front panel

### 5.8.1 Status indication

There are nine LED indicators on the front panel to provide router status information. Each ETH port has two additional LEDs that provide information about the port status.

Caption	Color	State	Description
PWR	Green	Blinking On Fast blinking	Router is ready Starting of the router Updating firmware
USR	Yellow	—	Function of this LED diode can be selected by user
POE	Yellow Green	On Blinking On  Blinking Off	PSE: insufficient power supply via PWR connector PSE: overload (device takes much power)/short circuit* PoE PD versions: The voltage present in ETH port PSE: correct power supply via PWR connector PSE: The device is powered via one of the ETH ports PD: The voltage not present in ETH port PSE: disabled (not enabled on any of ETH ports)
SIM	Green Yellow	On (Green color) On (Yellow color)	The first SIM card is active The second SIM card is active
WAN	Yellow	LED goes out 1x per one sec. LED goes out 1x per two sec. LED goes out 1x per five sec.	Signal strength is from -50 dBm to -69 dBm  Signal strength is from -70 dBm to -89 dBm or difference between neighbouring cells is exactly 3 dBm Signal strength is from -90 dBm to -113 dBm or difference between neighbouring cells is smaller than 3 dBm
DAT	Red	Blinking	Communication in progress on radio channel
IN0	Green	On	Binary input no. 0 is active
IN1	Green	On	Binary input no. 1 is active
OUT	Yellow	On	Binary output is active
ETH0 ETH1	Green	On Off	Selected 100 Mbit/s Selected 10 Mbit/s
ETH0 ETH1	Yellow	On Blinking Off	The network cable is connected Data transmission The network cable is not connected

Table 9: Status indication

\* Additionally it can indicate a device without PoE support connected on the other side of the cable. In this case the indication is caused by low impedance (lower than 500 Ω) of the device without PoE support. This can be solved by disabling the PoE PSE feature on the relevant ETH port in the router's Web interface, see *Configuration manual* [2].



The status indication of the WAN LED is updated every 10 seconds.

### 5.8.2 Power connector PWR

Panel socket 2-pin.

Pin number	Signal mark	Description
1	GND(-)	Negative pole of DC supply voltage
2	VCC(+)	Positive pole of DC supply voltage (+10 to +60 V DC)

Table 10: Connection of power connector

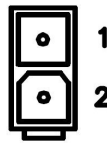

Figure 29: Power connector

The power supply for the router must be between +10 V to +60 V DC supply. Protection against reversed polarity without signaling is built into the router. **Note:** The protection against reversed polarity is lost if the negative pole is grounded!

The router can be put into low power mode using a special command `lpm`. It can then be awakened, for example, by an activity on binary input or using an internal timer.



Circuit example:

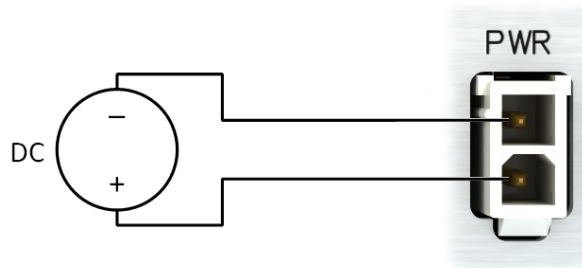

Figure 30: Connection of power supply



**Note for PoE:** See Chapter 5.8.7 for information on how PoE versions of the router impact the power supply usage. The power supply for a PoE PSE router has to meet other specific requirements.

### 5.8.3 Antenna connector ANT, DIV, GPS and WiFi

The main, diversity and GPS antennas are connected to the router using the SMA connector on the front panel. There is also an R-SMA antenna connector available, through which an additional antenna can be connected, if the router is equipped with a WiFi module.

The *ANT* connector is used to connect the main antenna to the router. To connect the diversity antenna, the second antenna connector *DIV* is used. The third connector (*GPS*) is intended for a GPS antenna (the router supports active GPS antennas). An R-SMA connector named *WiFi* is designed for the connection of a WiFi antenna (available only for versions with a WiFi module).



The router can not operate without a main antenna connected through the port marked as *ANT*!



An SMA connector is used for the connection of the antenna. The antenna is connected by screwing this antenna to the SMA connector on the front panel of the router (see figure below).

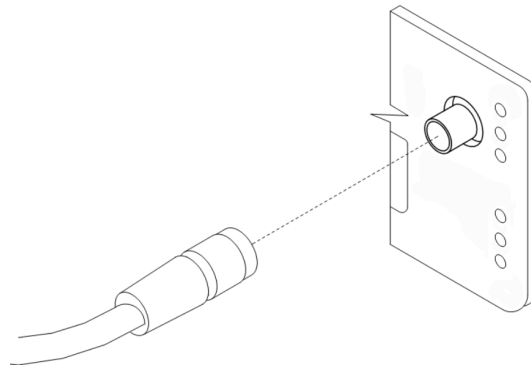

Figure 31: Connecting the antenna



A diversity antenna improves the radio capability of the router at low signal strength.

### 5.8.4 SIM card reader

Two SIM card readers for 3 V and 1.8 V SIM cards are located on the rear panel of the router. In order for the router to function, it is necessary to insert an activated SIM card with an unblocked PIN code. The SIM cards may have different adjusted APNs (Access Point Names).



#### Changing the SIM card:

- Always disconnect the router from power supply before handling the SIM card!
- Using a plastic opening tool, or your fingernail, press the SIM card slightly into its slot until you hear a click.
- After hearing this click, release the card and it will pop out of its slot.
- Remove the SIM card and push any other SIM card into the slot until it clicks into place.

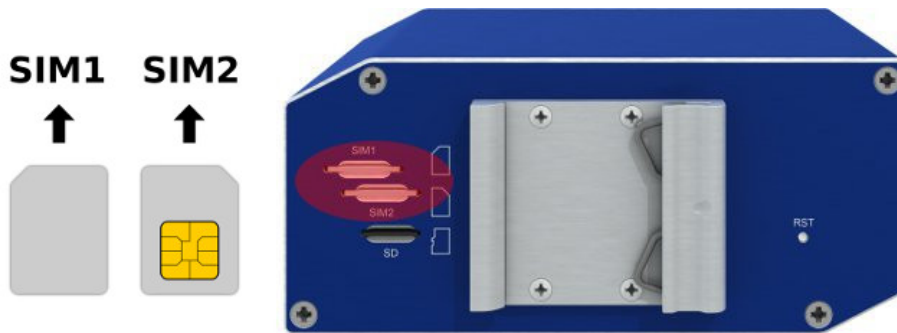

Figure 32: SIM cards

### 5.8.5 MicroSD card reader

The microSD card reader is located on the rear panel of the router (the third slot). This card reader allows the router to operate with microSD memory cards. The technical specifications are stated in the table below.

Technical specifications of microSD card		
Supported technologies		SDHC, SDXC
Supported capacity	SDHC	up to 32 GB
	SDXC	from 32 GB to 64 GB
Supported microSD card filesystems		vfat, ext2, ext3, ext4

Table 11: Technical specifications of microSD card



**Changing the microSD card:**



- Using the flat end of a spudger, or your fingernail, press the microSD card slightly into its slot until you hear a click.
- After hearing this click, release the card and it will pop out of its slot.
- Remove the microSD card and push any other microSD card into the slot until it clicks into place.



Figure 33: MicroSD card

**5.8.6 Ethernet Ports (ETH0 and ETH1)**

Panel socket RJ45.

Pin	Signal mark	Description	Data flow direction
1	TXD+	Transmit Data – positive pole	Input/Output
2	TXD-	Transmit Data – negative pole	Input/Output
3	RXD+	Receive Data – positive pole	Input/Output
4	DC+	PoE power + (if it's equipped by PoE)	
5	DC+	PoE power + (if it's equipped by PoE)	
6	RXD-	Receive Data – negative pole	Input/Output
7	DC-	PoE power - (if it's equipped by PoE)	
8	DC-	PoE power - (if it's equipped by PoE)	

Table 12: Connection of Ethernet connector

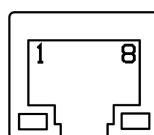

Figure 34: Ethernet connector

The crossover UTP cable (Ethernet cable) plugs into the RJ45 connector labeled as ETH0 or ETH1 (see figure below).

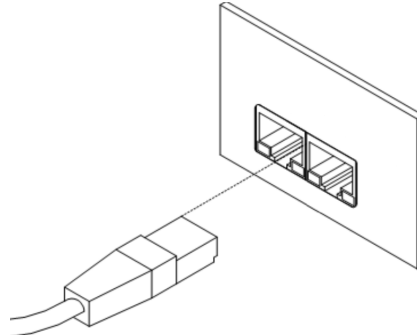

Figure 35: Connection of Ethernet cable



The insulation strength of Ethernet ports from each other and from the rest of the router (grounding) is dependent on the router version:

Router Version	Insul. Strength from Router	Insul. Strength between Ports
Without PoE	1.5 kV	1.5 kV
PoE PD	1.5 kV	none
PoE PSE	none	none

Table 13: Insulation strength of Ethernet ports

### 5.8.7 Power over Ethernet (PoE)

On the router models with PoE, the PoE+ standard IEEE 802.3at-2009 and PoE standard IEEE 802.3af-2003 are supported in both Ethernet ports (ETH0, ETH1). The PoE PD version allows the router to be powered over the Ethernet by another PoE PSE device. The PoE PSE version also allows the router to power other devices over the Ethernet.

#### PoE PD

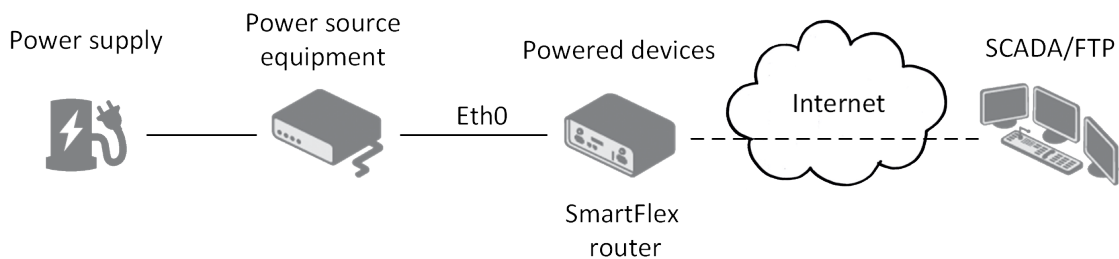

Figure 36: PoE PD usage

The PoE PD parameters can be found in Chapter 7.8. The POE LED on the front panel of the router lights up green when voltage is present in an Ethernet port so the user knows the router can be PoE powered. You can still power the router with this connector even if the router is powered with PoE (in PoE PD version), but the input voltage must be higher than 15 V DC. If the input voltage is lower than 15 V DC and the PoE voltage is present (PoE LED green on), the router will still be powered from the Ethernet connector via PoE.

**Note:** You can not power the router via the SWITCH version ETH2 connectors. The PoE PD is available on the ETH0 and ETH1 ports only.

### PoE PSE

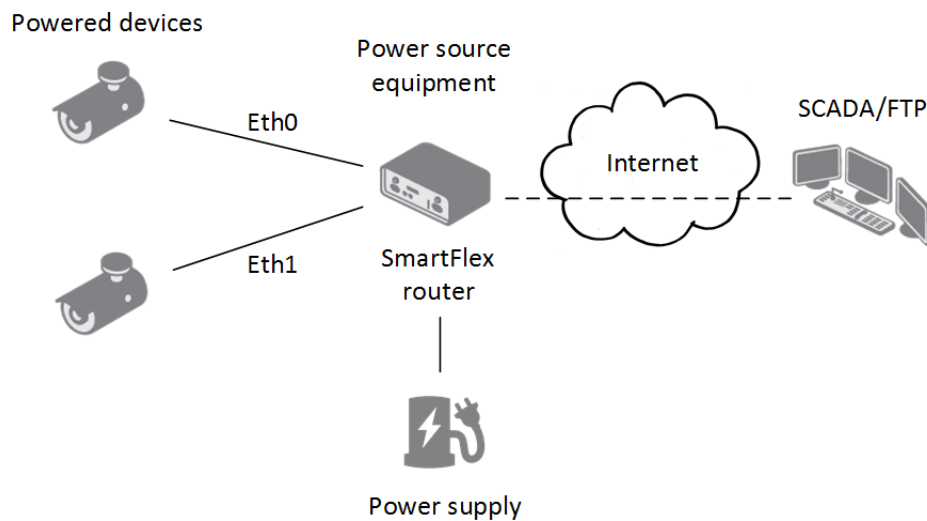

Figure 37: PoE PSE usage



The power supply used with the PoE PSE router has to provide voltage from 44 to 57 V DC and the output power has to be at least 65 W for full PoE+ use (Class 4) in both Ethernet ports (ETH0 and ETH1).

The PoE PSE parameters can be found in Chapter 7.8. The PoE state is indicated by the POE LED on the front panel of the router, see Chap. 5.8.1. When sufficient voltage (44 to 57 V) and power is available is indicated by the green light. A yellow POE LED indicates insufficient power or voltage through the PWR connector. When a device is being powered from the router, the POE LED is will show blinking green. Yellow blinking is shown for an overload (the powered device is using too much power) or a short circuit (incorrect wiring of the cable or of the device without PoE support).

You can enable or disable the PoE PSE feature separately on the ETH0 and ETH1 ports via the Web interface of the router. This can be found in the LAN configuration pages (*Primary* for ETH0, *Secondary* for ETH1). When PoE PSE is enabled, you can find the current, voltage, power and power class information on the *General* page of the router's Web interface. See the *Configuration manual* [2]. Via SSH or in scripts you can use the Shell command `pse`.

### 5.8.8 USB Port

Panel socket USB-A.

Pin	Signal mark	Description	Data flow direction
1	+5 V	Positive pole of 5 V DC supply voltage, 0.5 A	
2	USB data -	USB data signal – negative pole	Input/Output
3	USB data +	USB data signal – positive pole	Input/Output
4	GND	Negative pole of DC supply voltage	

Table 14: Connection of USB connector



Figure 38: USB connector



The USB port is disabled on overload to prevent its damage (connected device is trying to get too high current). The port is enabled again after reboot of the router.

### 5.8.9 I/O Port

Panel socket 6-pin.

Pin	Signal mark	Description
1	IN0	Binary input 0
2	IN0	Binary input 0
3	IN1	Binary input 1
4	IN1	Binary input 1
5	OUT	Binary output
6	OUT	Binary output

Table 15: Connection of I/O port

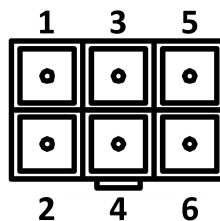

Figure 39: I/O connector

The I/O user Interface is designed for the processing of binary input and control (setting) of binary output. Binary output is open in the default configuration. The isolation strength is 1.5 kV. The pins are isolated from each other with the same strength.

The input circuits are bipolar and allow connection as needed with common plus or minus (according to the connection of an external voltage).

**Binary inputs**

- Characteristics of inputs:

logical 0/1*	Voltage	Current	Web interface status
log. 1 max	3 V	0.4 mA	Off
log. 0 min	5 V	0.7 mA	On
log. 0 type	12 V	2 mA	On
log. 0 max	60 V	7 mA	On

Table 16: Characteristics of inputs

\* The binary input status in the Shell is returned via `io get bin0` or `io get bin1`.

- Binary inputs connection example:

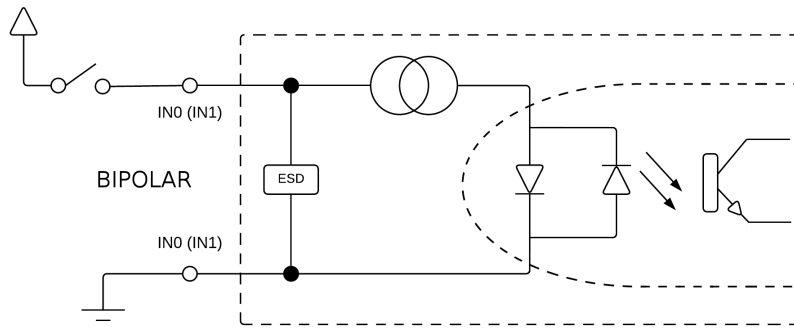

Figure 40: Binary inputs connection

## Binary output

- Binary output parameters:
  - 60 V AC / 300 mA
  - 60 V DC / 300 mA
- The current of the binary output is limited by a resettable fuse (300 mA).
- Binary output connection example:

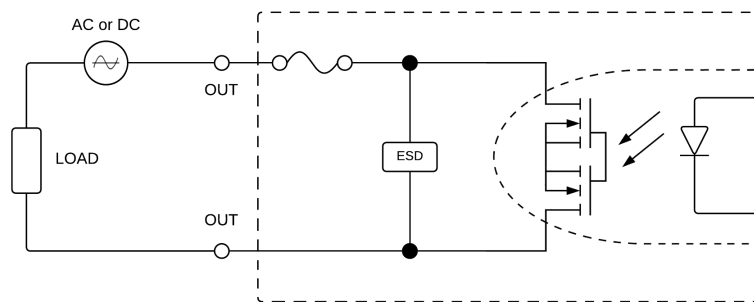

Figure 41: Binary output connection

### 5.8.10 Reset

When the *PWR* LED starts flashing on the front panel, it is possible to restore the default configuration of the router by pressing the *RST* button on the rear panel. After pressing this button the default configuration will be restored and the router will reboot (after which the green LED will be on).



In order to press the *RST* button it is necessary to use a narrow screwdriver or any other small tool.

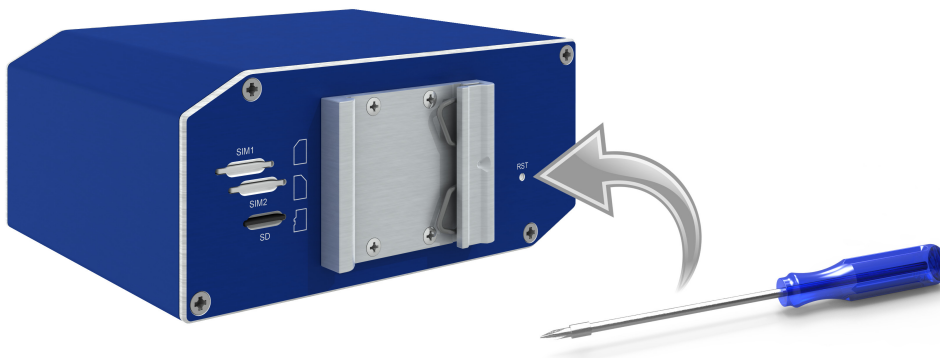

Figure 42: Router reset



Before resetting the router, it is recommended to back up the router configuration settings (see *Configuration manual*) because resetting the router will return all configuration settings to their default states.

It is important to distinguish between the router reset and reboot.

Action	Router behavior	Invoking events
Reboot	Turns off and then turns on the router	Disconnect and reconnect the power, press the <i>Reboot</i> button in the web configuration
Reset	Restores the default configuration and reboots the router	Press the <i>RST</i> button

Table 17: Description of router reset and restart

## 5.9 Interfaces Description

Besides the basic version of SmartFlex router there are available versions with one of the following interfaces:

- RS232 interface
- RS232-RS485/422 interface
- SWITCH interface
- RS232-RS485-ETH interface

### 5.9.1 RS232 interface

This interface is physically connected through the RJ45 connector. The RS232 converter is protected against bus overloads. State indication is displayed by LEDs on the RJ45 connector, as shown in the table below. This router version complies with the standards and temperature ranges stated in Chap. 7.1.

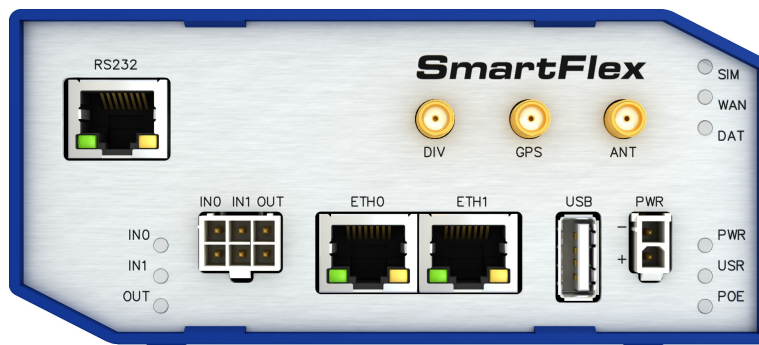

Figure 43: Version with RS232 interface

Connection of connector:

Pin	Signal	Description	Direction
1	RTS	Request To Send	Input
2	CTS	Clear To Send	Output
3	DTR	Data Terminal Ready	Input
4	DSR	Data Set Ready – connect to +3 V through R 330 Ohm	Output
5	GND	Signal ground	
6	TXD	Transmit Data	Output
7	CD	Carrier Detect	Output
8	RXD	Receive Data	Input

Table 18: Connection of RS232 connector



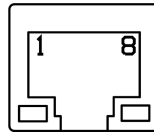

Figure 44: RS232 connector



Example of a meter connection to router:

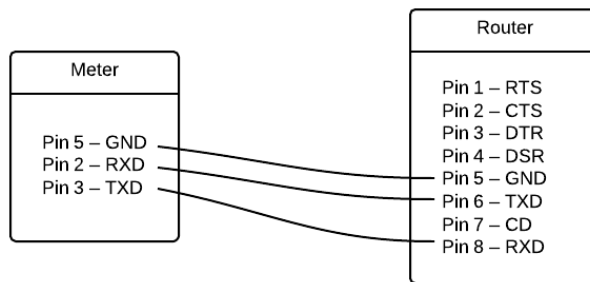

Figure 45: Meter connection to router

State indication of RS232 interface:

Description of indication	
Green LED	Indicates receiving data
Yellow LED	Indicates transmitting data

Table 19: State indication of RS232 interface

Technical specification of RS232 bus (EN 1434):

RS232 interface	
Max. operating bus current	15 mA
Max. data rate	230400 bit/s
Max. total cable length (300 Bd, 200 nF/km)	20 m

Table 20: RS232 interface technical specification

### 5.9.2 RS232-RS485/422 interface

These interfaces are physically connected through the 5-pin and 4-pin terminal block connectors. The insulation strength is up to 2.5 kV. **Attention, connectors are not isolated from each other!** No state indication is displayed for this interface. These router versions comply with the standards and temperature ranges stated in Chap. 7.1.

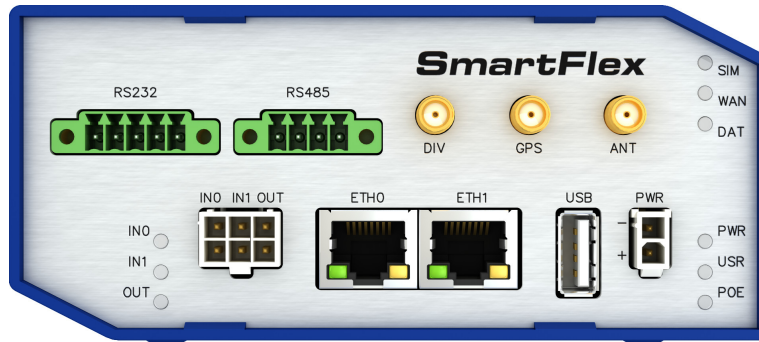

Figure 46: Version with RS232-RS485/422 interface

Connection of RS232 connector:

Pin	Signal	Description	Direction
1	CTS	Clear To Send	Output
2	RTS	Request To Send	Input
3	GND	Signal ground*	—
4	RXD	Receive Data	Input
5	TXD	Transmit Data	Output

Table 21: Connection of RS232 connector

\* Both connectors (RS232 and RS485/422) have a common ground connection.

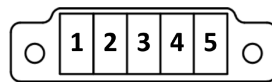

Figure 47: RS232 connector

Connection of RS485 connector:

Pin	Signal	Description	Direction
1	TxRx-	RS485 B (-)	Input/Output
2	TxRx+	RS485 A (+)	Input/Output
3	TxRx-	RS485 B (-)	Input/Output
4	TxRx+	RS485 A (+)	Input/Output

Table 22: Connection of RS485 connector

Connection of RS422 connector:

Pin	Signal	Description	Direction
1	RxD-	RS422 (-)	Output
2	RxD+	RS422 (+)	Output
3	TxD-	RS422 (-)	Input
4	TxD+	RS422 (+)	Input

Table 23: Connection of RS422 connector

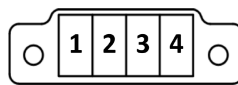

Figure 48: RS485/422 connector

The selection of either RS485 or RS422 can be performed by using jumpers on the board. The points where jumpers have to be mounted are shown on the port (see figure below). Three jumpers are required for the RS485 interface or one jumper for the RS422 interface. **The default configuration is RS485 with termination off.**

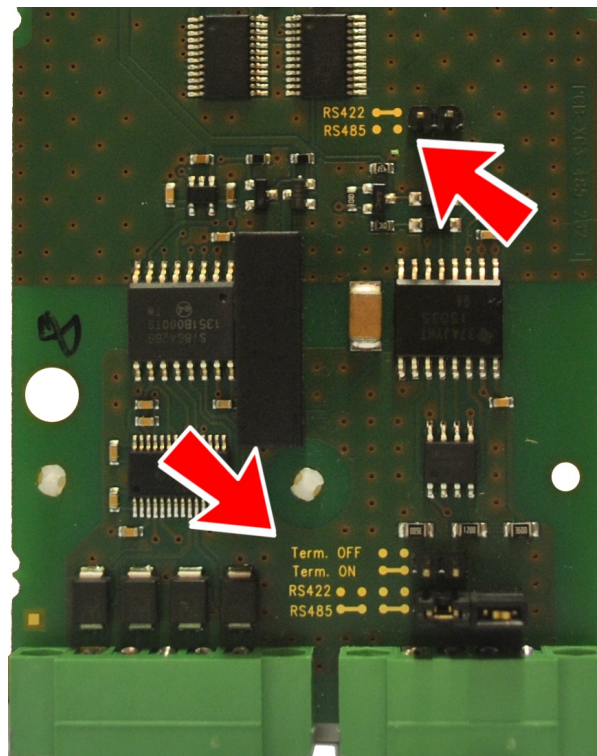

Figure 49: Connection of jumpers

Technical specification of RS232 and RS485 bus (EN 1434):

RS232 and RS485 interface	
Max. operating RS232 bus current	15 mA
Max. number of devices on RS485 bus (each 1,5 mA)	256
Max. data rate	230400 bit/s on RS232 38400 bit/s on RS485
Max. total cable length (300 Bd, 200 nF/km)	RS232 20 m, RS485 1200 m

Table 24: Technical specification of RS232 and RS485

### 5.9.3 SWITCH interface

The three LAN ports of the SWITCH interface for SmartFlex routers (RJ45 connectors for connecting Ethernet devices) act as a typical switch device. This means that the router reads Ethernet frames (data packets on an Ethernet link) from any port on the SWITCH interface and transmits them on other ports of the SWITCH interface. Each port can transmit frames independently on the other ports. State indication is displayed separately on each connector. These router versions comply with the standards and temperature ranges stated in Chap. 7.1 except for having a lower maximum operating temperature, which is +70 °C.

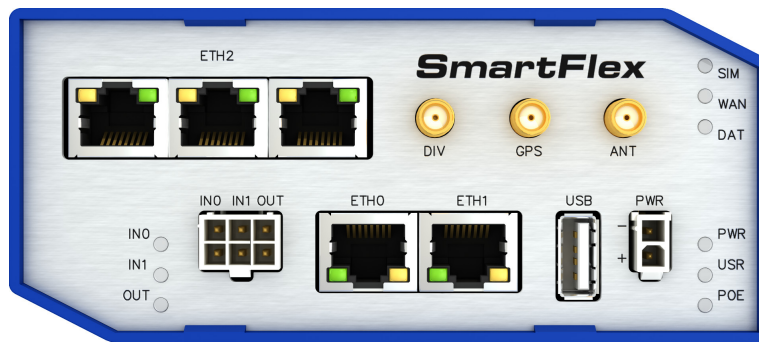

Figure 50: Version with SWITCH board

State indication of the interface:

Description of indication		
Green LED	On	Selected 100 Mbit/s
	Off	Selected 10 Mbit/s
Yellow LED	On	The network cable is connected
	Blinking	Data transmission
	Off	The network cable is not connected

Table 25: State indication of the SWITCH interface

Technical specification of Ethernet IEEE 802.3:

Ethernet interface, IEEE 802.3 standard	
Maximum data rate	100 Mbit/s
Max. total cable length (300 Bd, 200 nF/km)	100 m

Table 26: SWITCH interface parameters

### 5.9.4 RS232-RS485-ETH interface

This interface board includes a panel RJ45 connector for Ethernet connection (ETH2 in the figure), and four-pin and three-pin terminal block connectors for RS232 and RS485 connection. The insulation strength is up to 2.5 kV between the ETH2 and RS485 interfaces and from the rest of the router, too. The RS232 interface is not insulated from the rest of the router. State indication is displayed by LEDs above each connector, as shown in the table below. These router versions comply with the standards and temperature ranges stated in Chap. 7.1.

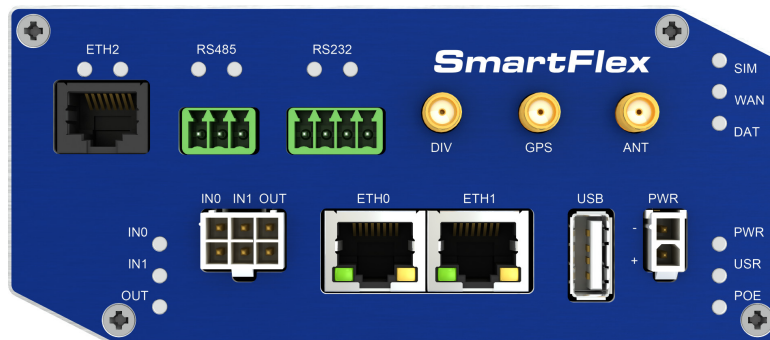

Figure 51: Version with RS232-RS485-ETH interface

Connection of ETH connector:

Pin	Signal	Description	Direction
1	TXD+	Transmit Data – positive pole	Input/Output
2	TXD-	Transmit Data – negative pole	Input/Output
3	RXD+	Receive Data – positive pole	Input/Output
4	—	—	—
5	—	—	—
6	RXD-	Receive Data – negative pole	Input/Output
7	—	—	—
8	—	—	—

Table 27: Connections of the Ethernet Connector

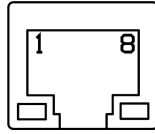

Figure 52: Ethernet connector

Connection of RS485 connector:

Pin	Signal	Description	Direction
1	GND	Signal ground*	—
2	TxRx-	RS485 B(-)	Input/Output
3	TxRx+	RS485 A(+)	Input/Output

Table 28: Connections of Terminal Block Connector RS485

\* Signal ground is isolated from the router's ground.

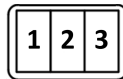

Figure 53: RS485 connector

Connection of RS232 connector:

Pin	Signal	Description	Direction
1	AUX	+5 V/500 mA	—
2	GND	Signal ground*	—
3	RXD	Receive Data	Input
4	TXD	Transmit Data	Output

Table 29: Connections of Terminal Block Connector RS232

\* Common with router's signal ground.

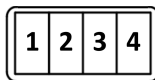

Figure 54: RS232 connector

State indication of the interface:

Description of indication		
ETH2 – green LED	On Off	Selected 100 Mbit/s Selected 10 Mbit/s
ETH2 – Yellow LED	On Blinking Off	The network cable is connected Data transmission The network cable is not connected
RS485, RS232 – green LED		Indicates Receive data
RS485, RS232 – yellow LED		Indicates Transmit data

Table 30: State indication of the RS232-RS485-ETH interface

Technical specification of RS232 and RS485 bus (EN 1434) and Ethernet IEEE 802.3:

ETH2, RS485 and RS232 interface	
Max. operating RS232 bus current	15 mA
Max. number of devices on RS485 bus (each 1,5 mA)	256
Max. data rate	230400 bit/s on RS232 38400 bit/s on RS485 100 Mbit/s on ETH2
Max. total cable length (300 Bd, 200 nF/km)	RS232 20 m RS485 1200 m ETH2 100 m

Table 31: Technical specification of RS232, RS485 and Ethernet

# 6. First Use

## 6.1 Connecting the router before first use

Before putting the router into operation it is necessary to connect all of the components that are required to run your applications. Don't forget to insert a SIM card.



The router can not operate without a connected antenna, SIM card and power supply. If the antenna is not connected, the router may be damaged.

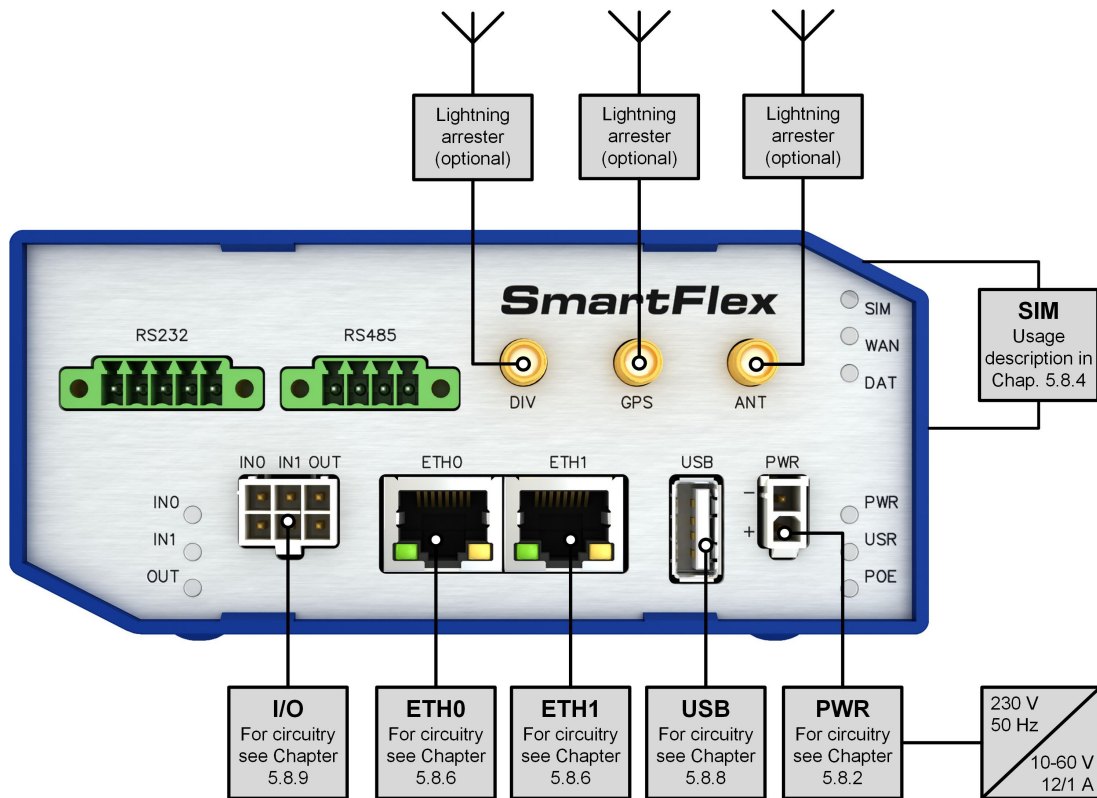

Figure 55: Router connection



## 6.2 Start

The router will start when a power supply is connected to the router. By default, the router will automatically start to log on to the default APN. The DHCP server will start to assign addresses for devices connected through the Ethernet port ETH0. These router behaviors can be changed via the web interface. This is described in detail in the *Configuration manual for SmartFlex routers*.

## 6.3 Configuration



**Attention!** If no SIM card is inserted in the router, it is not possible for the router to operate. Any inserted SIM card must have active data transmission.

### 6.3.1 Configuration by web browser

For status monitoring, configuration and administration of the router a web interface is available which can be accessed by entering the IP address of the router into the web browser. The default IP address of the router is 192.168.1.1. **Attention, it is necessary to use HTTPS protocol for secure communication over a network!**

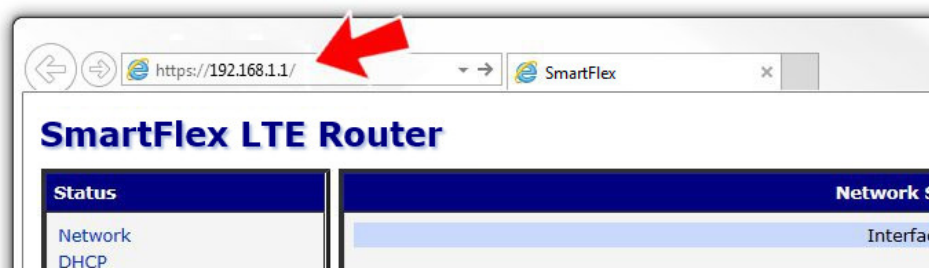

Figure 56: Entering the IP address of the router

By default, configuration can only be performed with the default username "root" and default password "root".

Figure 57: Entering login information

After successfully entering login information, the user will have access to the router web interface via their browser.

<b>Status</b>	<b>General Status</b>
<b>Configuration</b>	
<b>Customization</b>	
<b>Administration</b>	
General	Mobile Connection
Mobile WAN	SIM Card : Primary IP Address : 10.0.6.239 Rx Data : 1.0 KB Tx Data : 3.3 KB Uptime : 0 days, 0 hours, 1 minute » More Information «
WiFi	Primary LAN
WiFi Scan	IP Address : 192.168.1.1 / 255.255.255.0 MAC Address : 7C:66:9D:35:8B:74 Rx Data : 165.3 KB Tx Data : 431.7 KB » More Information «
Network	Secondary LAN
DHCP	IP Address : 192.168.2.1 / 255.255.255.0 MAC Address : 7C:66:9D:35:8B:76 Rx Data : 1.1 KB Tx Data : 7.9 KB » More Information «
IPsec	Tertiary LAN
DynDNS	IP Address : 192.168.3.1 / 255.255.255.0 MAC Address : 00:80:0F:11:70:00 Rx Data : 0 B Tx Data : 0 B » More Information «
System Log	WiFi
LAN	IP Address : 192.168.4.1 / 255.255.255.0 MAC Address : 34:B1:F7:E1:2A:84 Rx Data : 0 B Tx Data : 0 B » More Information «
VRRP	Peripheral Ports
Mobile WAN	Expansion Port 1 : Ethernet Switch Expansion Port 2 : None Binary Input 1 : Off Binary Input 2 : Off Binary Output : Off
PPPoE	System Information
WiFi	Firmware Version : 0.1_RC2 (2014-10-07) BETA Serial Number : N/A Profile : Standard Supply Voltage : 12.0 V Temperature : 45 °C Time : 2000-01-01 01:09:29 Uptime : 0 days, 0 hours, 4 minutes
WLAN	
Backup Routes	
Firewall	
NAT	
OpenVPN	
IPsec	
GRE	
L2TP	
PPTP	
DynDNS	
NTP	
SNMP	
SMTP	
SMS	
Expansion Port 1	
Expansion Port 2	
USB Port	
Startup Script	
Up/Down Script	
Automatic Update	
User Modules	
Remote Access	
Change Profile	
Change Password	
Add User	
Delete User	
Set Real Time Clock	
Set SMS Service Center	
Unlock SIM Card	
Send SMS	
Backup Configuration	
Restore Configuration	
Update Firmware	
Reboot	

Figure 58: Router web interface



A detailed description of the router settings in the Web interface can be found in the *Configuration manual for SmartFlex routers*.

# 7. Technical Parameters

## 7.1 Basic parameters

SmartFlex Router		
Temperature range	Operating Storage	-40 °C to +75 °C -40 °C to +85 °C
Cold start	-35 °C	Data transfers via mobile network are available immediately
	-40 °C	Data transfers via mobile network are available approximately five minutes after the start of the router. Everything else is functional immediately.
Humidity	Operating Storage	0 to 95 % relative humidity non condensing 0 to 95 % relative humidity non condensing
Altitude	Operating	2000 m / 70 kPa
Degree of protection		IP30
Supply voltage		10 to 60 V DC
Consumption	Idle	2.5 W
	Average	4 W
	Peak	11 W
	Sleep mode	10 mW
Dimensions		55 x 97 x 125 mm (DIN 35 mm, EN 60715)
Weight	Plastic box	approximately 170 g (depends on interface)
	Metal box	approximately 375 g (depends on interface)
Antenna connectors		SMA – 50 Ohm
User interface	2x ETH	Ethernet (10/100 Mbit/s)
	USB	USB 2.0
	I/O	6-pin panel socket

Table 32: Basic parameters

## 7.2 Standards and regulations

The router complies with the following standards and regulations.

<b>Standards and regulations</b>	
Telecom and emission	ETSI EN 301 511 v9.0.2, ETSI EN 301 908-1 v5.2.1, ETSI EN 301 908-2 v5.2.1, ETSI EN 301 908-13 v5.2.1, ETSI EN 300 328 v1.8.1
EMC	ETSI EN 301 489-1 v1.9.2, IEC 61000-6-2:2005, IEC 61000-6-3:2006
Safety	EN 60950-1:2006 + A11:2009 + A1:2010 + A12:2011 + A2:2013, EN 62311:2008
E8 – EMC for devices in transportation	E8 homologation number: 10R – 04 7737

Table 33: Standards and regulations

### 7.3 Type tests and environmental conditions

Phenomena	Test	Description	Test levels
ESD	EN 61000-4-2	Enclosure contact Enclosure air	± 6 kV (crit. A) ± 8 kV (crit. A)
RF field AM modulated	IEC 61000-4-3	Enclosure	20 V/m (crit. A) (80 – 2700 MHz)
Fast transient	EN 61000-4-4	Signal ports Power ports Ethernet ports	± 2 kV (crit. A) ± 2 kV (crit. A) ± 2 kV (crit. A)
Surge	EN 61000-4-5	Ethernet ports Power ports I/O ports	± 2 kV (crit. B), shielded cab. ± 0,5 kV (crit. B) ± 1 kV, L to L (crit. A) ± 2 kV, L to GND (crit. A)
RF conducted	EN 61000-4-6	All ports	10 V/m (crit. A) (0,15 – 80 MHz)
Radiated emission	EN 55022	Enclosure	Class B
Conducted emission	EN 55022	DC power ports Ethernet ports	Class B Class B
Power frequency magnetic field	EN 61000-4-8	Enclosure	160 A/m (crit. A)
Dry heat	EN 60068-2-2	+75 °C *, 40 % rel. humidity	
Cold	EN 60068-2-1	-40 °C *	
Dump heat	EN 60068-2-78	95 % rel. humidity (+40 °C)	

Table 34: Type tests and environmental conditions

\* The temperatures given are for the basic version of the router. These can vary for other versions.

## 7.4 Technical parameters of cellular module

Technical parameters of cellular module	
LTE parameters	Bit rate 100 Mbit/s (DL) / 50 Mbit/s (UL) UE CAT. 3 3GPP rel. 9 standard Supported bandwidths: 5 Mhz, 10 Mhz, 20 Mhz Supported frequencies: 800 / 900 / 1800 / 2100 / 2600 MHz
HSPA+ parameters	Bit rate 42 Mbit/s (DL) / 5,76 Mbit/s (UL) UE CAT. 24, 6 3GPP rel. 5, 6, 7, 8 standard Supported frequencies: 850 / 900 / 1900 / 2100 MHz
UMTS parameters	PS bit rate 384 kbit/s (DL) / 384 kbit/s (UL) 3GPP rel. 5, 6, 7, 8 standard W-CDMA FDD standard Supported frequencies: 850 / 900 / 1900 / 2100 MHz
GPRS/EDGE parameters	Data throughput max. 236 kbit/s 3GPP rel. 99 standard GPRS multislot class 10 EDGE multislot class 12 Coding schemes CS 1 to 4, MCS 1 to 9 Supported frequencies: 850 / 900 / 1800 / 1900 MHz
GPRS/EDGE power classes	GSM 850 CS: Class 4 (32 dBm) EGSM 900 CS: Class E2 (27 dBm) DCS 1800 CS: Class 1 (29 dBm) PCS 1900 CS: Class E2 (26 dBm)

Table 35: Technical parameters of cellular module

## 7.5 Technical parameters of GPS

GPS specifications	
Antenna	50 Ohms – active
Protocols	NMEA 0183 v3.0
Frequency	1575.42 MHz
Sensitivity	Tracking: -161 dBm* Acquisition (Assisted): -158 dBm** Acquisition (Standalone): -145 dBm**
Acquisition time	Hot start: 1 s Warm start: 29 s Cold start: 32 s
Accuracy	Horizontal: < 2m (50 %); < 5 m (90 %) Altitude: < 4 m (50 %); < 8 m (90 %) Velocity: < 0.2 m/s

Table 36: Technical parameters of GPS

\* Tracking sensitivity is the lowest GPS signal level for which the device can still detect an in-view satellite 98 % of the time when in sequential tracking mode.

\*\* Acquisition sensitivity is the lowest GPS signal level for which the device can still detect an in-view satellite 50 % of the time.

## 7.6 Technical parameters of WiFi

WiFi	
Antenna connector	R-SMA – 50 Ohms
Supported WiFi band	2.4 GHz, 5 Ghz
Standards	802.11a, 802.11b, 802.11g, 802.11n
2.4 GHz supported channels	1, 2, 3, 4, 5, 6, 7, 8, 9, 10, 11, 12, 13
5 GHz supported channels	36, 40, 44, 48, 52, 56, 60, 64, 149, 153, 157, 161, 165
Type of device	Access point, station
Max. clients in AP mode	10
WiFi TX Output Power	17,3 dBm
WiFi RX Sensitivity	-96,3 dBm

Table 37: Technical parameters of WiFi

## 7.7 Technical parameters of I/O port

- Characteristics of inputs:

logical 0 / 1*	Voltage	Current	Web interface status
log. 1 max	3 V	0.4 mA	Off
log. 0 min	5 V	0.7 mA	On
log. 0 type	12 V	2 mA	On
log. 0 max	60 V	7 mA	On

Table 38: Characteristics of inputs

\* The binary input status in the Shell is returned via `io get bin0` or `io get bin1`.

- Binary output parameters:
  - 60 V AC / 300 mA
  - 60 V DC / 300 mA

## 7.8 Technical Parameters of Power over Ethernet (PoE)

Standards IEEE 802.3at-2009 (PoE+) and IEEE 802.3af-2003 (PoE) are supported. Cabling needed is Category 5, up to 12.5 Ω. It is possible to use a passive PoE injector.

PoE PD: parameters for opposite PSE	
Input voltage range	42.5 – 57 V
Power available	25.50 W
Maximum current	600 mA

Table 39: PoE PD: parameters for opposite PSE

PoE PSE parameters	
Power supply needed	44 – 57 V, 65 W
Power available	2x 25.50 W (ETH0, ETH1)

Table 40: PoE PSE parameters



## 7.9 Other Technical Parameters

Other technical parameters	
CPU power	2 DMIPS per MHz
Flash memory	256 MB
RAM	512 MB
M-RAM	128 kB

Table 41: Other technical parameters

## 8. Recommended Literature

- [1] Advantech B+B SmartWorx: **Start Guide,**
- [2] Advantech B+B SmartWorx: **Configuration Manual for SmartFlex Routers.**

## 9. Troubleshooting



If you can not connect to the router from your PC, your network card may be configured the way it is not possible to connect to the router. Take one or more of the following steps to solve the problem:

- Select the communication rate 10 MB/s in the properties of your network card.
- Connect the router to the PC via Switch.
- Connect the router to the PC, start the router first and then start the PC after the router's initialization.

### 9.1 FAQ

 **I have NAT enabled. My equipment is not connecting to the network.**

- *The device's gateway has to be configured as the router.*

 **The router resets itself and the Ethernet connection fails.**

- *The router will not function without an antenna. Keep the antenna as far as possible from the power supply.*

 **I can't access the Web server over NAT.**

- *The remote HTTP access of the router has to be disabled, the default server address has to be your web server and the gateway of the web server has to be the IP of the router.*

 **Mobile WAN connection fails. (DAT LED off)**

- *Check signal power. If the signal power is weak, you will have to use a better antenna. If the neighboring cells have a similar signal strength, you will need to use a directional antenna. For proper operation, the signal levels have to be in the range from -50 dBm to -90 dBm.*
- *It is necessary to set ping, which will check the connection and, in the case of failed ping, restart connection.*

 **Mobile WAN connection cannot be established. (DAT LED off)**

- *Recheck GPRS settings – APN, name, password and IP address.*
- *Try to enter PIN – verify if the SIM card has the PIN code set.*
- *In a private APN, switch the DNS server send off.*
- *Switch the system log on and observe where the error occurs.*

 **Ethernet connection fails or isn't establishing.**

- *It is possible to turn auto negotiation off and set a rate and duplex manually on the Ethernet interface of the router.*

 **DynDNS doesn't function.**

- *With private APN this is not functional.*
- *If the same IP address is recorded in your canonic name as dynamically assigned address, it means that the operator is using NAT or firewall.*
- *Verify NAT using ping to the static server address.*
- *Verify Firewall accessing remotely to the router's Web interface.*
- *The operator may not provide the address of DNS server and without DNS server's adress it is impossible to connect to the dyndns.org server. There will be these messages in the system log:*
  - *DynDNS daemon started*
  - *Error resolving hostname: no such file or directory*
  - *Connect to DynDNS server failed*

 **L2TP or IPSec isn't establishing.**

- *Check the system log for error messages.*

 **I switched the router to offline mode by SMS message, but the router is in online mode after restart.**

- *SMS messages do not change the router configuration. They remain in effect only until the router is restarted.*

 **FTP doesn't function.**

- *Router doesn't support active FTP mode. It supports passive mode only.*

 **RS232 doesn't function.**

- *Verify that the router supports RS232 communications. Also verify the RS232 communication settings. To do so, open the router's configuration menu via the web browser, select the appropriate expansion port and verify the settings in the configuration menu.*