



RR Series Power Relays

Key features:

- SPDT through 3PDT, 10A contacts
- Midget power type relays
- Available in pin and blade terminal styles.
- Options include an indicator, check button for test operations and side flange.
- DIN rail, surface and panel mount sockets are available for a wide a variety of mounting applications.



Part Number Selection

| Contact | Model | Part Number | | Coil Voltage Code (Standard Stock Items in Bold) |
|-------------------------------------------------------------------------------------|---------------------------------|------------------------------------|------------------------------------|-----------------------------------------------------------------------------------------------|
| | | Pin Terminal | Blade Terminal* | |
|  | Standard | — | RR1BA-U <input type="checkbox"/> | AC6V, AC12V, AC24V, AC110V, AC120V , AC240V, DC6V, DC12V, DC24V , DC48V, DC110V |
| | With Indicator | | RR1BA-UL <input type="checkbox"/> | |
| | With Check Button | | RR1BA-UC <input type="checkbox"/> | |
| | With Indicator and Check Button | | RR1BA-ULC <input type="checkbox"/> | |
| | Side Flange Model | | RR1BA-US <input type="checkbox"/> | |
|  | Standard | RR2P-U <input type="checkbox"/> | RR2BA-U <input type="checkbox"/> | |
| | With Indicator | RR2P-UL <input type="checkbox"/> | RR2BA-UL <input type="checkbox"/> | |
| | With Check Button | RR2P-UC <input type="checkbox"/> | RR2BA-UC <input type="checkbox"/> | |
| | With Indicator and Check Button | RR2P-ULC <input type="checkbox"/> | RR2BA-ULC <input type="checkbox"/> | |
| | Side Flange Model | — | RR2BA-US <input type="checkbox"/> | |
|  | Standard | RR3PA-U <input type="checkbox"/> | RR3B-U <input type="checkbox"/> | |
| | With Indicator | RR3PA-UL <input type="checkbox"/> | RR3B-UL <input type="checkbox"/> | |
| | With Check Button | RR3PA-UC <input type="checkbox"/> | RR3B-UC <input type="checkbox"/> | |
| | With Indicator and Check Button | RR3PA-ULC <input type="checkbox"/> | RR3B-ULC <input type="checkbox"/> | |
| | Side Flange Model | — | RR3B-US <input type="checkbox"/> | |

 *Blade type not TUV tested or CE marked.
Side flange model mounts directly to panel with no socket required.

Ordering Information
When ordering, specify the Part No. and coil voltage code:
(example) **RR3B-U** **AC120V**
Part No. Coil Voltage Code

Sockets



| Relays | Standard DIN Rail Mount | Finger-safe DIN Rail Mount | Through Panel Mount |
|------------------------|-------------------------|----------------------------|---------------------|
| RR2P | SR2P-05 SR2P-06 | SR2P-05C | SR2P-51 |
| RR3PA | SR3P-05 SR3P-06 | SR3P-05C | SR3P-51 |
| RR1BA RR2BA RR3B | SR3B-05 | — | SR3B-51 |







 All DIN rail mount sockets shown here can be mounted using DIN rail BNDN1000.

Switches & Pilot Lights | Signaling Lights | Relays & Sockets | Timers | Contactors | Terminal Blocks | Circuit Breakers

Hold Down Springs & Clips

| Appearance | Description | Relay | For DIN Mount Socket | For Through Panel & PCB Mount Socket |
|-----------------------------------------------------------------------------------|--------------------------|--------------------|----------------------|--------------------------------------|
|  | Pullover Wire Spring | RR2P | SR2B-02F1 | SR3P-01F1 |
| | | RR3PA | SR3B-02F1 | |
| | | RR1BA, RR2BA, RR3B | SR3B-02F1 | SR3B-02F1 |
|  | Leaf Spring (side latch) | RR2P, RR3PA | SFA-203 | — |

Accessories

| Item | Appearance | Use with | Part No. | Remarks |
|-------------------------------------|-----------------------------------------------------------------------------------|------------------------------------------------------|----------|-------------------------------------------------------------------------------------------------------------------------------------------------------------------------------------------------------------------------|
| Aluminum DIN Rail (1 meter length) |  | All DIN rail sockets | BNDN1000 | The BNDN1000 is designed to accommodate DIN mount sockets. Made of durable extruded aluminum, the BNDN1000 measures 0.413 (10.5mm) in height and 1.37 (35mm) in width (DIN standard). Standard length is 39" (1,000mm). |
| DIN Rail End Stop |  | DIN rail | BNL5 | 9.1 mm wide. |
| Replacement Hold-Down Spring Anchor |  | Horseshoe clip for sockets SR3B-05, SR2P-06, SR3P-06 | Y778-011 | For use on DIN rail mount socket when using pullover wire hold down spring. 2 pieces included with each socket. |
| |  | Chair clip for sockets SR2P-05(C), SR3P-05(C) | Y703-102 | |

Specifications

| | | | |
|------------------------------------|----------------------------------------------|--------------------------------------|--------------------|
| Contact Material | Silver | | |
| Contact Resistance ¹ | 30 mΩ maximum | | |
| Minimum Applicable Load | 1V DC, 10 mA | | |
| Operating Time ² | 25 ms maximum | | |
| Release Time ² | 25 ms maximum | | |
| Power Consumption (approx.) | AC: 3 VA (50 Hz), 2.5 VA (60 Hz) DC: 1.5W | | |
| Insulation Resistance | 100 MΩ minimum (500V DC megger) | | |
| Dielectric Strength | Pin Terminal | Between live and dead parts: | 1500V AC, 1 minute |
| | | Between contact and coil: | 1500V AC, 1 minute |
| | | Between contacts of different poles: | 1500V AC, 1 minute |
| | | Between contacts of the same pole: | 1000V AC, 1 minute |
| | Blade Terminal | Between live and dead parts: | 2000V AC, 1 minute |
| | | Between contact and coil: | 2000V AC, 1 minute |
| | | Between contacts of different poles: | 2000V AC, 1 minute |
| | | Between contacts of the same pole: | 1000V AC, 1 minute |
| Operating Frequency | Electrical: | 1800 operations/h maximum | |
| | Mechanical: | 18,000 operations/h maximum | |
| Vibration Resistance | Damage limits: | 10 to 55 Hz, amplitude 0.5 mm | |
| | Operating extremes: | 10 to 55 Hz, amplitude 0.5 mm | |
| Shock Resistance | Damage limits: | 1000 m/s ² (100g) | |
| | Operating extremes: | 100 m/s ² (10G) | |
| Mechanical Life | 10,000,000 operations | | |
| Electrical Life | 200,000 operations (220V AC, 5A) | | |
| Operating Temperature ³ | -25 to +40°C (no freezing) | | |
| Operating Humidity | 5 to 85% RH (no condensation) | | |
| Weight (approx.) (Standard type) | RR2P: 90g, RR3PA: 96g, RR1BA/RR2BA/RR3B: 82g | | |



1. Measured using 5V DC, 1A voltage drop method
2. Measured at the rated voltage (at 20°C), excluding contact bouncing
3. For use under different temperature conditions, refer to Continuous Load Current vs. Operating Temperature Curve.

Coil Ratings

| Rated Voltage (V) | Rated Current (mA) ±15% (at 20°C) | | Coil Resistance (Ω) ±10% (at 20°C) | Operating Characteristics (values at 20°C) | | |
|-------------------|-----------------------------------|-------|------------------------------------|--------------------------------------------|----------------|-----------------|
| | 50 Hz | 60 Hz | | Maximum Continuous Applied Voltage | Pickup Voltage | Dropout Voltage |
| AC (50/60 Hz) | 6 | 490 | 420 | 110% | 80% maximum | 30% minimum |
| | 12 | 245 | 210 | | | |
| | 24 | 121 | 105 | | | |
| | 110 | 27 | 23 | | | |
| | 120 | 24 | 20.5 | | | |
| | 240 | 12.1 | 10.5 | | | |
| DC | 6 | 240 | | 110% | 80% maximum | 10% minimum |
| | 12 | 120 | | | | |
| | 24 | 60 | | | | |
| | 48 | 30 | | | | |
| | 110 | 13 | | | | |

Contact Ratings

| Maximum Contact Capacity | | | | | |
|--------------------------|-------------------------|----------------|-------------|----------------------|----------------------|
| Continuous Current | Allowable Contact Power | | Rated Load | | |
| | Resistive Load | Inductive Load | Voltage (V) | Res. Load | Ind. Load |
| | | | 10A | 1650VA AC 300W DC | 1100VA AC 150W DC |



Note: Inductive load for the rated load — $\cos \phi = 0.3$, L/R = 7 ms

TÜV Ratings

| Voltage | |
|---------|-----|
| 240V AC | 10A |
| 30V DC | 10A |



AC: $\cos \phi = 1.0$, DC: L/R = 0 ms

UL Ratings

| Voltage | Resistive | General use | Horse Power Rating |
|---------|-----------|-------------|--------------------|
| 240V AC | 10A | 7A | 1/3 HP |
| 120V AC | 10A | 7.5A | 1/4 HP |
| 30V DC | 10A | 7A | — |

CSA Ratings

| Voltage | Resistive | General use |
|---------|-----------|-------------|
| 240V AC | 10A | 7A |
| 120V AC | 10A | 7.5A |
| 100V DC | — | 0.5A |
| 30V DC | 10A | 7.5A |

Socket Specifications

| | Relays | Terminal | Electrical Rating | Wire Size | Torque |
|-----------------------------|----------|----------------------------------------------|--------------------------------|---------------------|----------------|
| DIN Rail Sockets | SR2P-05 | M3 screw with captive wire clamp | 300V, 10A | Maximum 2 - #12 AWG | 9 - 11.5in•lbs |
| | SR2P-05C | M3 screw with captive wire clamp, fingersafe | 300V, 10A | Maximum 2 - #12 AWG | 9 - 11.5in•lbs |
| | SR2P-06 | M3 screw with captive wire clamp | 300V, 10A | Maximum 2 - #12 AWG | 9 - 11.5in•lbs |
| | SR3P-05 | M3 screw with captive wire clamp | 300V, 10A | Maximum 2 - #12 AWG | 9 - 11.5in•lbs |
| | SR3P-05C | M3 screw with captive wire clamp, fingersafe | 300V, 10A | Maximum 2 - #12 AWG | 9 - 11.5in•lbs |
| | SR3P-06 | M3 screw with captive wire clamp | 300V, 10A | Maximum 2 - #12 AWG | 9 - 11.5in•lbs |
| | SR3B-05 | M3 screw with captive wire clamp | 300V, 15A (10A)* (*CSA rating) | Maximum 2 - #12 AWG | 9 - 11.5in•lbs |
| Through Panel Mount Sockets | SR2P-51 | Solder | 300V, 10A | — | — |
| | SR3P-51 | Solder | 300V, 10A | — | — |
| | SR3B-51 | Solder | 300V, 10A | — | — |

Characteristics (Reference Data)

Electrical Life Curves

AC Load

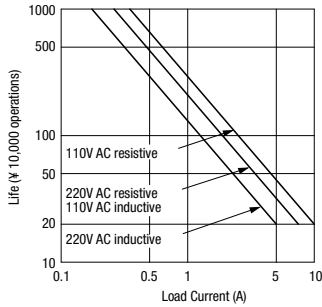

DC Load

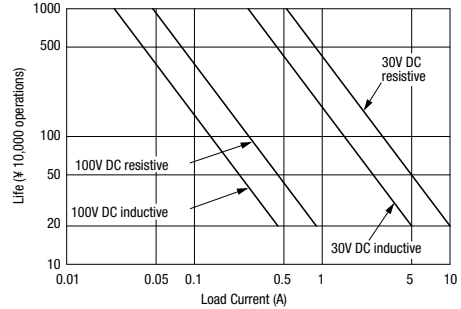

Maximum Switching Capacity

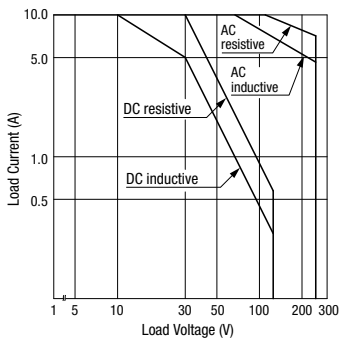

Continuous Load Current vs. Operating Temperature Curve (Standard Type, With Check Button, and Side Flange Type)

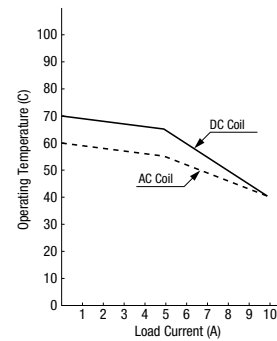

Internal Connection (View from Bottom)

Standard Type

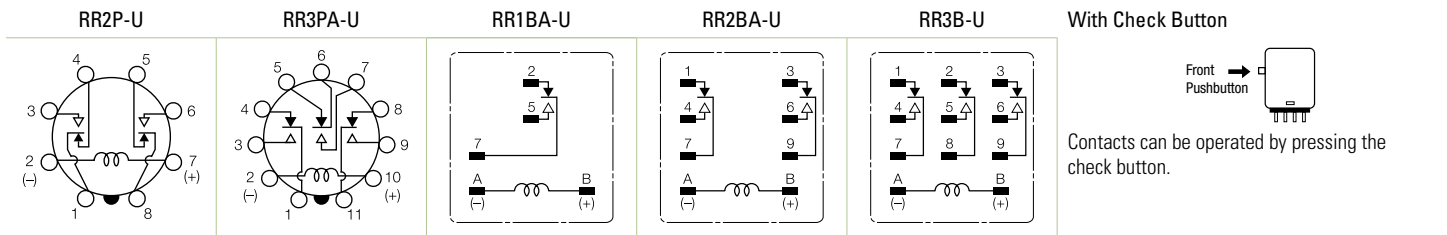

With Indicator (-UL type)

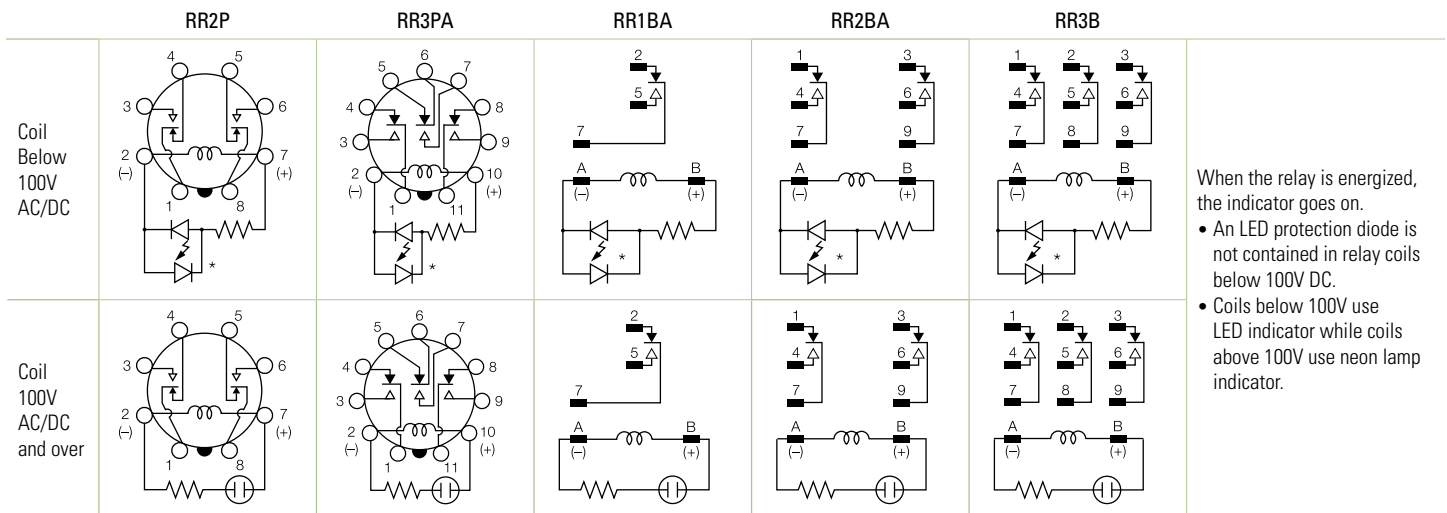

Switches & Pilot Lights

Signaling Lights

Relays & Sockets

Timers

Contactors

Terminal Blocks

Circuit Breakers

Dimensions (mm)

RR2P-U/RR2P-UL

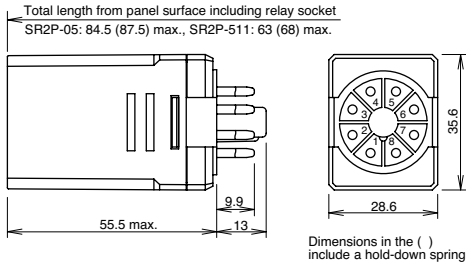

RR3PA-U/RR3PA-UL

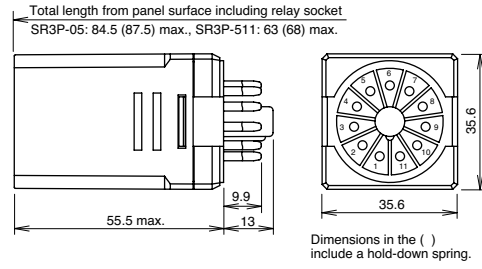

RR1BA-U/RR2BA-UL/RR2BA-U
RR2BA-UL/RR3B-U/RR3B-UL

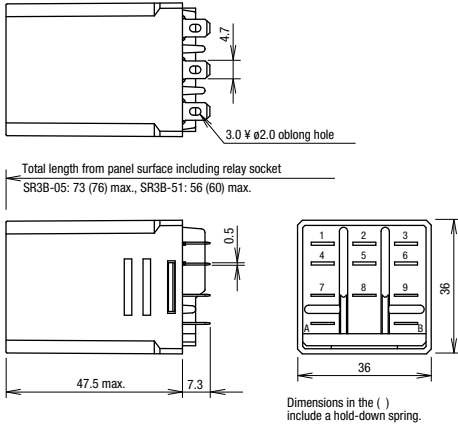

RR1BA-US/RR2BA-US/RR3B-US

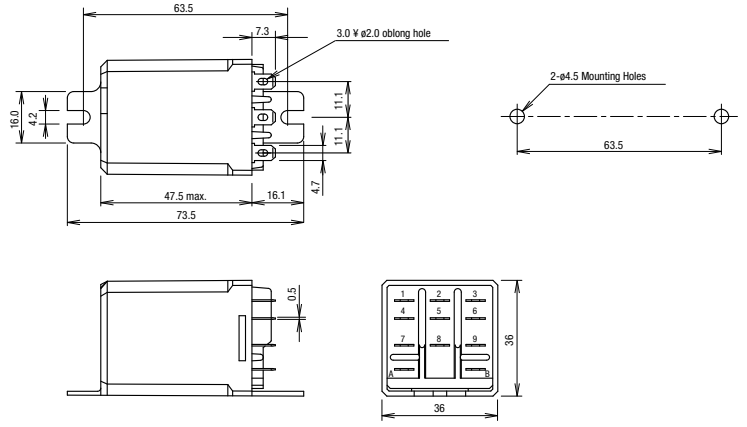

Standard DIN Rail Mount Sockets

SR2P-05

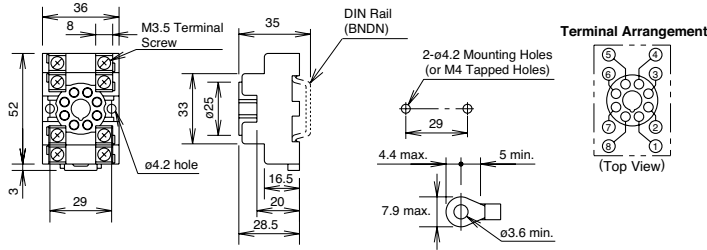

SR2P-06

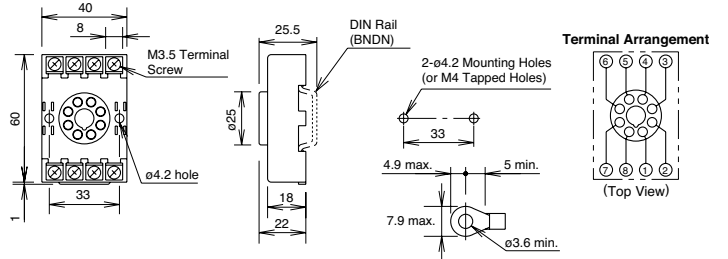

SR3P-05

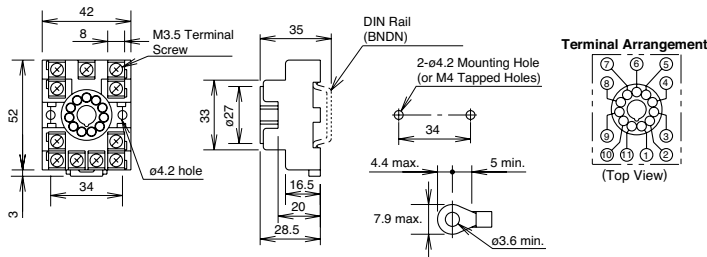

SR3P-06

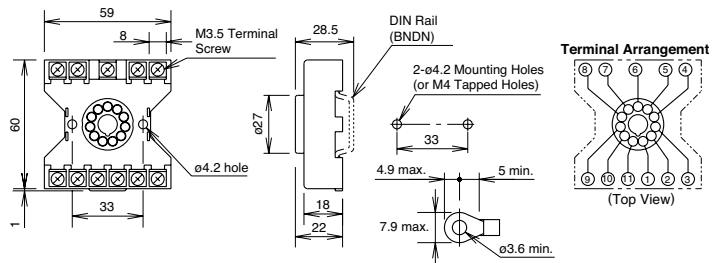

Switches & Pilot Lights

Signaling Lights

Relays & Sockets

Timers

Contactors

Terminal Blocks

Circuit Breakers