

## 1. Features

- Antenna for ISM 868 and 915 MHz applications including LoRa, SigFox, and Weightless-P.
- Frequency bands from 863- 928MHz
- Maintains high performance on device: DFI (Designed for Integration)
- Corner placement to save space
- Low profile innovative design.
- SMD mounting
- Supplied in Tape and Reel
- Automotive temperature rating

## 2. Description

Grandis uses a ground plane on the host PCB to radiate effectively. The antenna itself requires a clearance underneath. An external matching circuit is used to optimise the antenna within a device to the required bands. Designed specifically for 868/915 ISM applications that require a small robust solution. Grandis comes in Left and Right hand versions to optimise placement on a host PCB.

## 3. Applications

- Industrial/Scientific/Medical (ISM)
- Remote monitoring/ Smart meters
- Network Devices
- Manufacturing automation
- Agriculture/Environment
- Consumer tracking

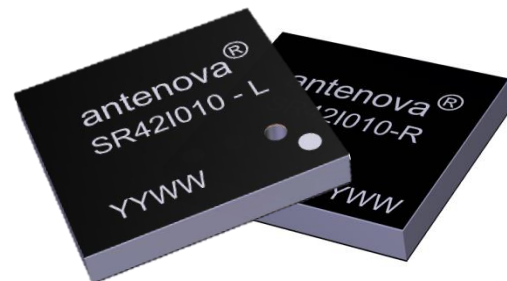

## 4. Part Number

**Grandis Left: SR42I010-L**

**Grandis Right: SR42I010-R**

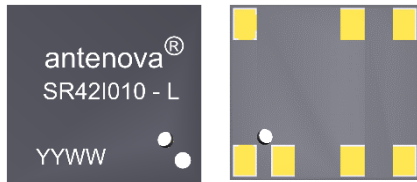

## 5. General Data

Product name	Grandis
Part Number	SR42I010-L; SR42I010-R
Frequency	863 – 928MHz
Polarization	Linear
Operating temperature	-40°C to140°C
Environmental Condition Test	ISO16750-4 5.1.1.1/5.1.2.1/5.3.2
Impedance with matching	50 Ω
Weight	< 2g
Antenna type	SMD
Dimensions	12.0 x 11.0 x 1.7 (mm)

## 6. RF Characteristics

	ISM 868	ISM 915	Dual band mode
	863 – 870 MHz	902 – 928 MHz	863 – 928MHz
<b>Peak gain</b>	0.2dBi	0.4dBi	0.2dBi
<b>Average gain (Linear)</b>	-2.50dBi	-2.20dBi	-4.0dBi
<b>Average efficiency</b>	>60%	>65%	>45%
<b>Maximum return loss</b>	<-18dB	<-10dB	<-6dB
<b>Maximum VSWR</b>	1.2:1	1.8:1	3.1:1

All data measured on Antenna's evaluation PCB  
Part No. SR42I010-EVB-1

## 7. RF Performance

The performance is shown for two tuned variants (Tuning dependant on required band). Matching circuit is used for band selection.

### 7.1 Return Loss

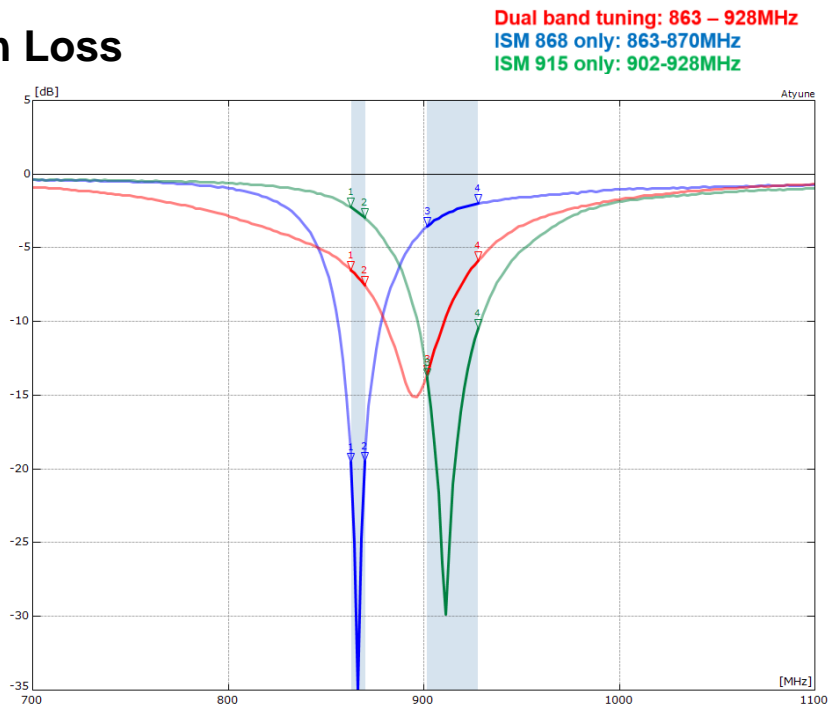

### 7.2 VSWR

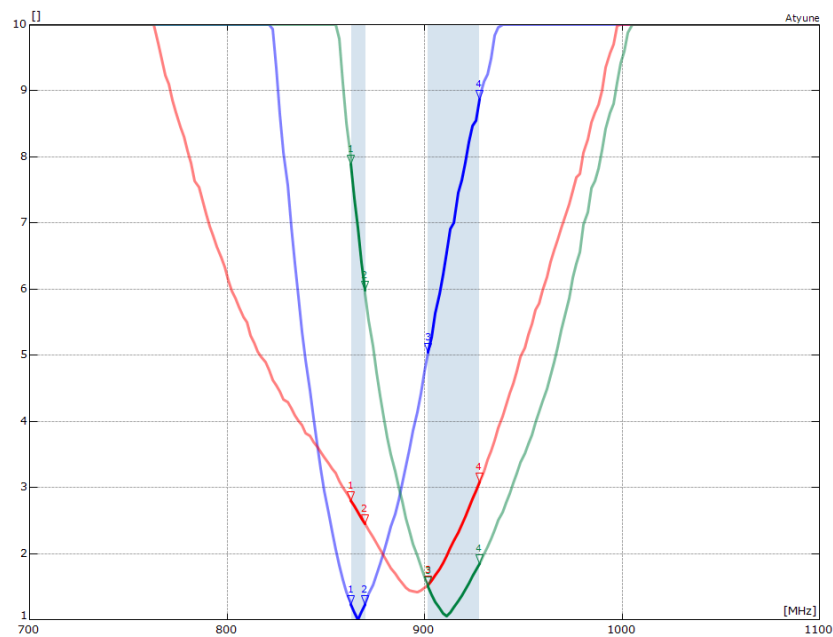

## 7.3 Antenna pattern

### 7.3.1 863 – 870 MHz

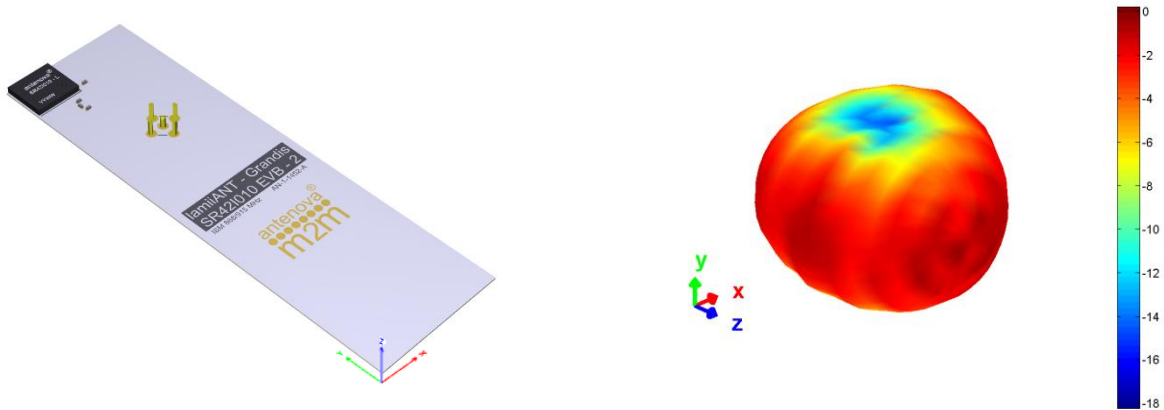

#### 3D pattern at 867 MHz

Drag to rotate pattern and PCB by using Adobe Reader  
(Click to Activate)

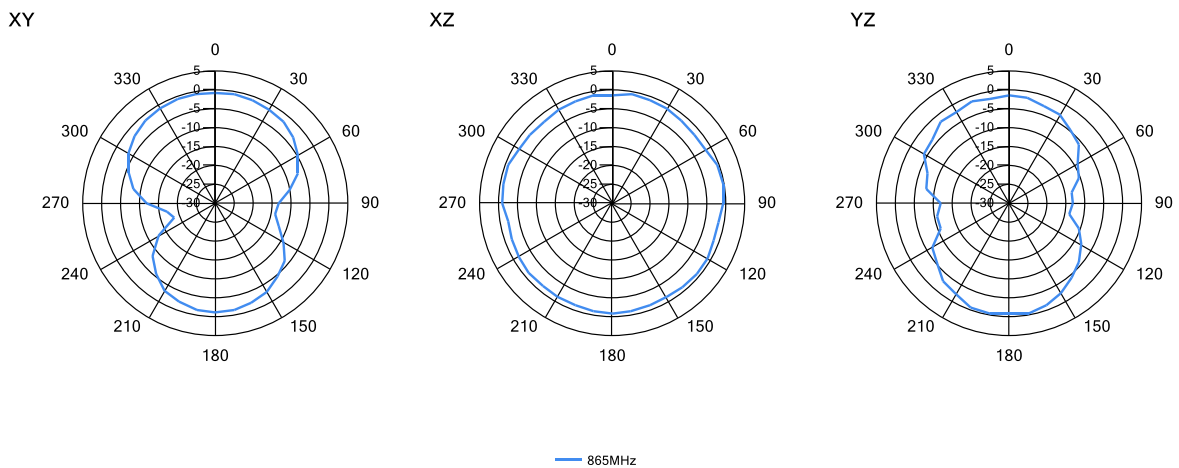

### 7.3.2 902 – 928 MHz

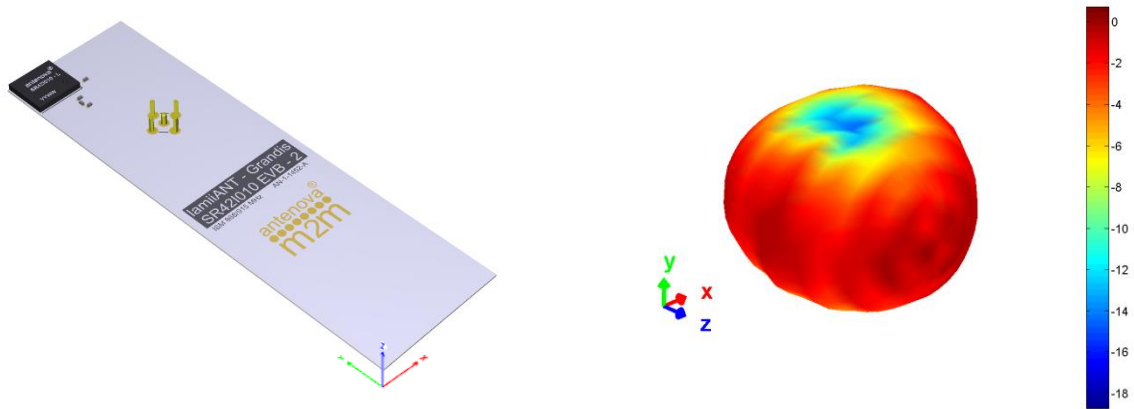

**3D pattern at 915 MHz**  
*Drag to rotate pattern and PCB by using Adobe Reader  
(Click to Activate)*

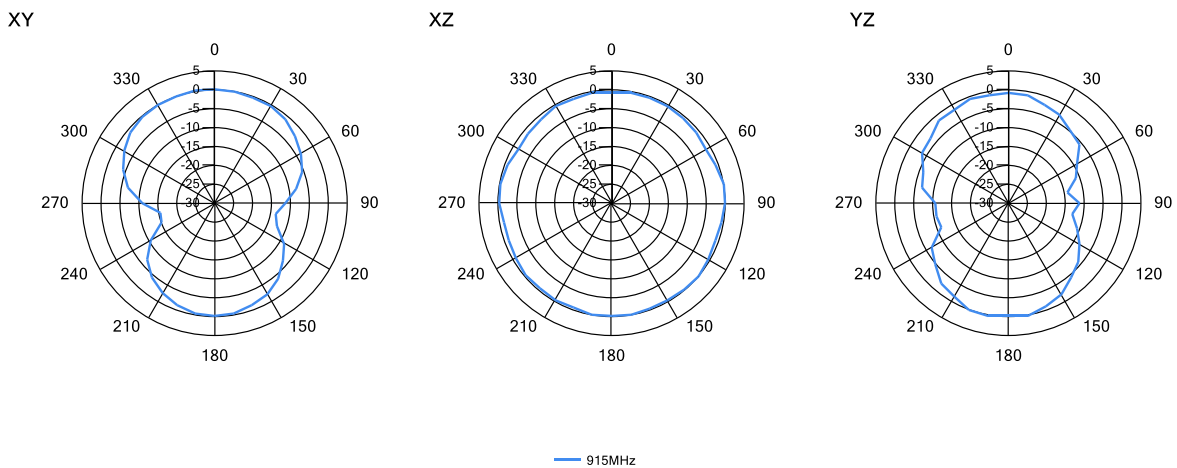

## 8. Antenna Dimensions

Grandis Left: SR42I010-L

Grandis Right: SR42I010-R

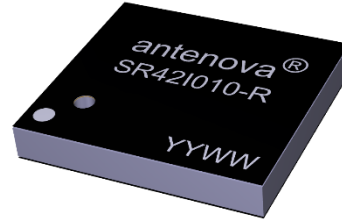

Top side

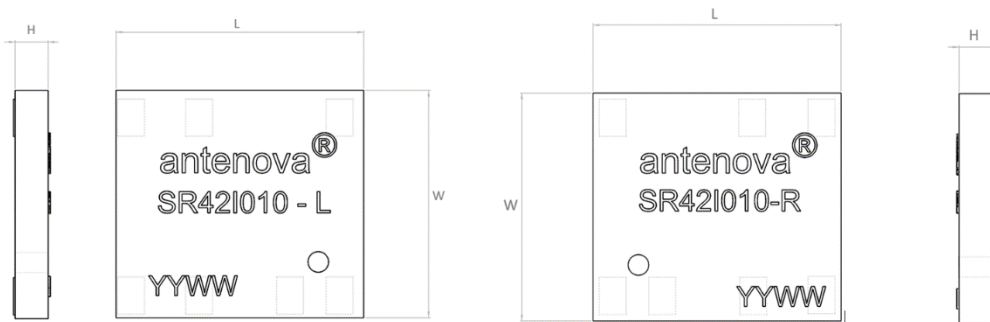

L	W	H
Length	Width	Height
12.0 ±0.1	11.0 ±0.1	1.7 +0.1 -0.0

All Dimensions in (mm)

Bottom Side

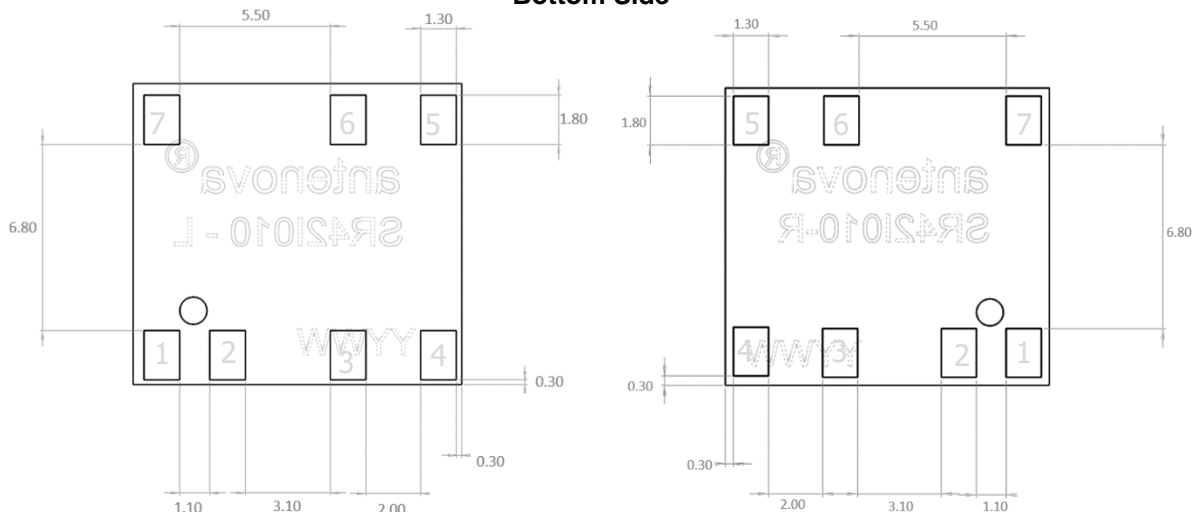

All Dimensions in (mm)

Antennas for Wireless Applications

## 9.0 Schematic symbol and Pin definition

The circuit symbol for the antenna is shown below. The antenna has 9 pins with only two as functional. All other pins are for mechanical strength.

Pin	Description
2	Feed
1	Band Select (B.SEL)
3,4,5,6,7	Not used (Mechanical only)

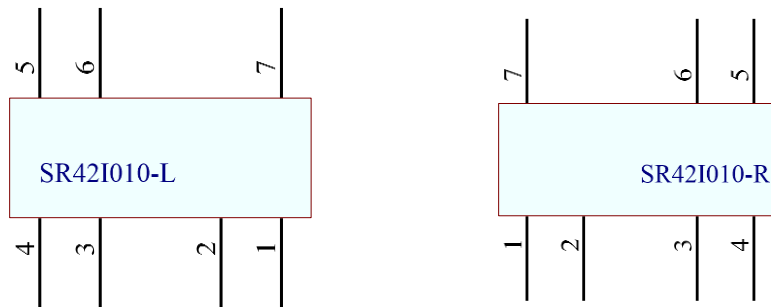

## 10.0 Antenna footprint

The recommended host PCB footprint is below.

**Grandis Left: SR42I010-L**

**Grandis Right: SR42I001-R**

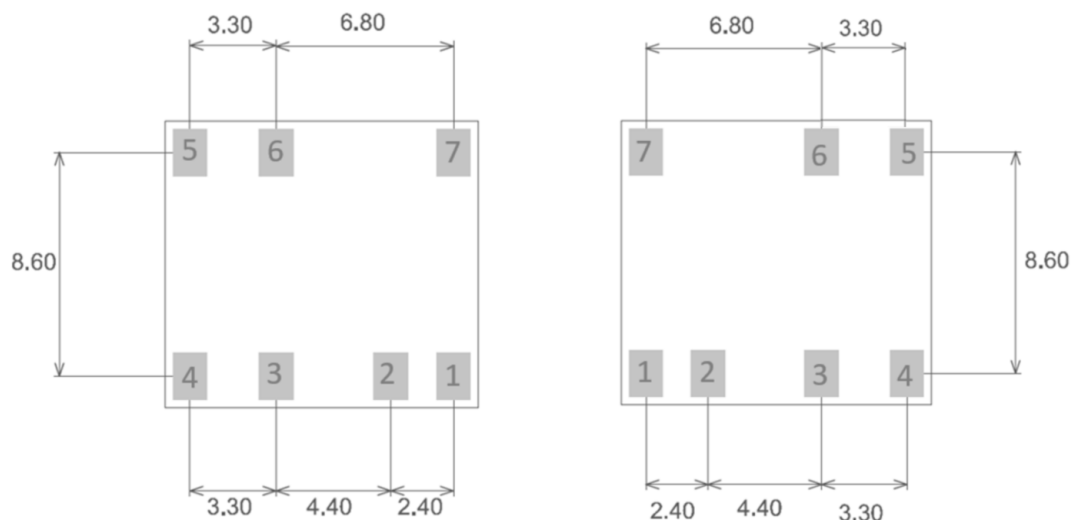

7 copper pads all 1.8 x 1.3 (mm)  
All Dimensions in mm

## 11. Electrical Interface

### 11.1 Transmission Line

All transmission lines should be designed to have a characteristic impedance of 50Ω.

- The length of the transmission lines should be kept to a minimum
- Any other parts of the RF system like transceivers, power amplifiers, etc, should also be designed to have an impedance of 50 Ω

Once the material for the PCB has been chosen (PCB thickness and dielectric constant), a coplanar transmission line can easily be designed using any of the commercial software packages for transmission line design. For the chosen PCB thickness, copper thickness and substrate dielectric constant, the program will calculate the appropriate transmission line width and gaps on either side of the track so the characteristic impedance of the co-planar transmission is 50 Ω.

### 11.2 Matching Circuit

The antenna requires a matching circuit that must be optimized for each product. The matching circuit will require up to five components and the following circuit should be designed into the host PCB. Not all components may be required but should be included as a precaution. The matching network must be placed close to the antenna feed to ensure it is more effective in tuning the antenna.

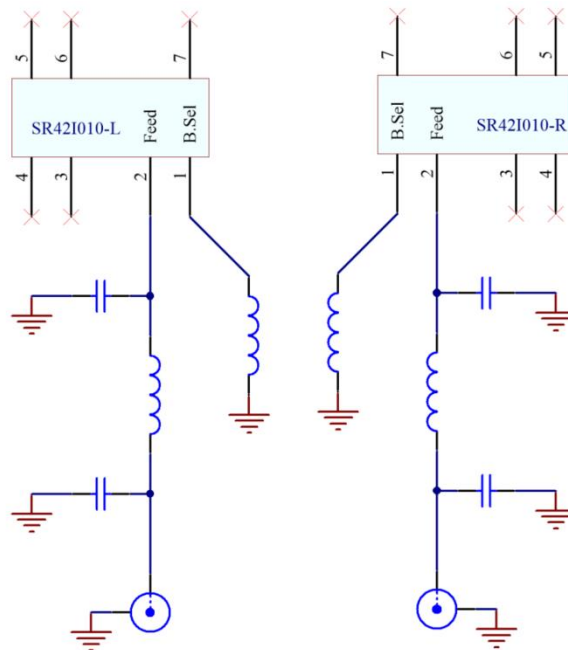



## 12.0 Antenna Integration Guide

### 12.1 Antenna Placement

Whatever the size of the host PCB, the antenna should be placed ideally on the host PCB's shortest side in the corner. The antenna should be placed in the corresponding corner: SR42I010-L (Left corner) and SR42I010-R (Right Corner).

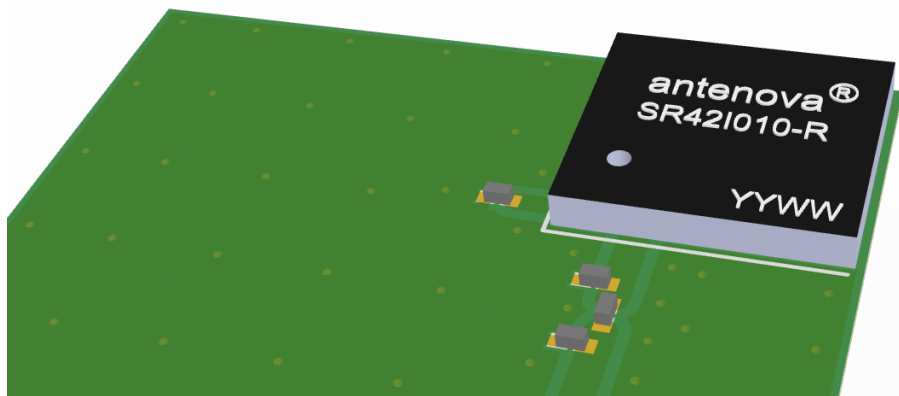

### 12.2 Host PCB Layout

The design for the host PCB must ensure that the footprint and clearance meets the antenna specification. An example of the PCB layout shows the antenna footprint with clearance. The feed (Pin 2) connects to the matching circuit close to the antenna. For Pin 1 (B.SEL) the component should be close to this pin.

Example host layout



## 12.3 Host PCB Clearance

Below shows the antenna footprint and clearance through all layers on the PCB. Only the antenna pads and connections to feed and GND are present within this clearance area. The clearance area required is 12.0 x 11.0 (mm).

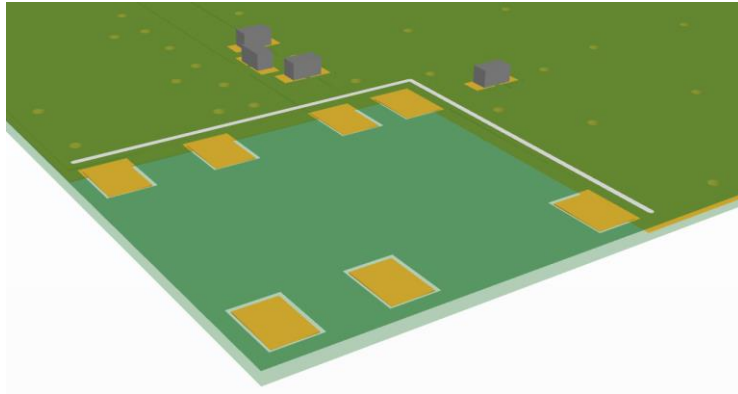

The clear-out area is simply defined as the same size as the antenna. No additional clearance is required.

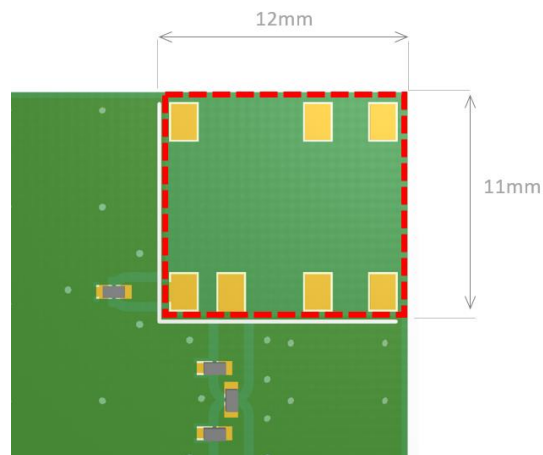
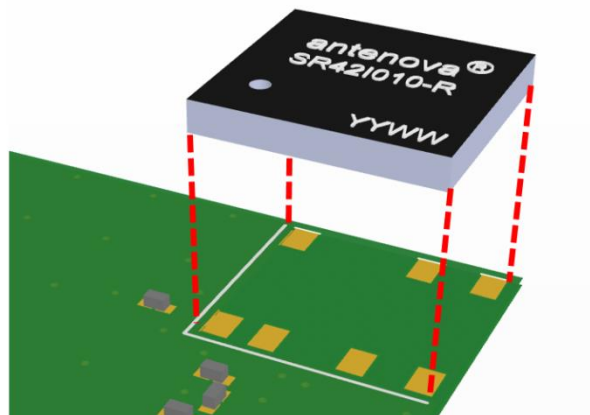

--- Clearance area

## 13.0 Reference Board

The reference board has been designed for the purpose of evaluating the SR42I010 antenna and includes a SMA female connector.

SR42I010-EVB-1 Evaluation Board (For SR42I010-R)



SR42I010-EVB-2 Evaluation Board (For SR42I010-L)



To order a reference board please see [www.antenna.com](http://www.antenna.com)  
Please order Left or Right version.

SR42I010-EVB-1 = SR42I010-R (Right)

SR42I010-EVB-2 = SR42I010-L (Left)

## 13.1 Reference Board Matching Circuit

The reference board has been designed for evaluation purposes of SR42I010-L and SR42I010-R and includes a SMA female connector.

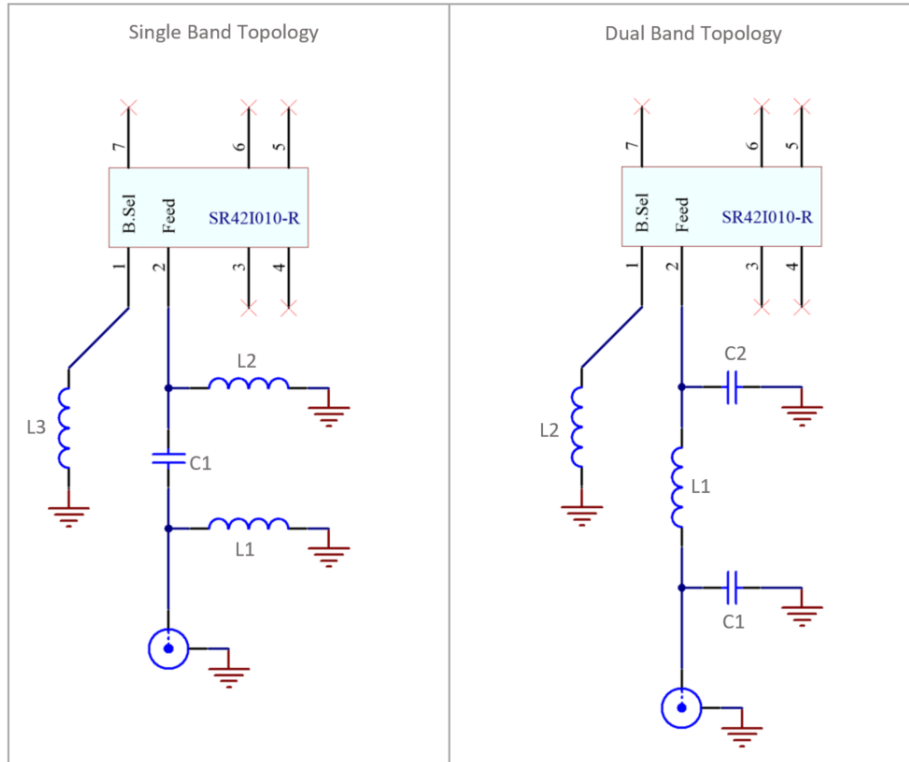

### Single Band Matching

Designator	Type	Value	Description
C1	Capacitor	2.2pF	Murata GJM15HN series
L1, L2	Not Fitted	Not Fitted	Not Fitted

B.SEL (Band Selection pin component)				
Frequency band	Designator	Type	Value	Description
ISM 868	L3	Inductor	4.2nH	Murata LQG15 series
ISM 915	L3	Inductor	2.2nH	Murata LQG15 series

### Dual Band Matching

Designator	Type	Value	Description
C1	Capacitor	6.8pF	Murata GJM15HN series
C2	Capacitor	10pF	Murata GJM15HN series
L1	Inductor	4.7nH	Murata LQG15 series
L2	Inductor	1.8nH	Murata LQG15 series

## 14. Soldering

This antenna is suitable for lead free soldering.

The reflow profile should be adjusted to suit the device, oven and solder paste, while observing the following conditions:

- The maximum temperature should not exceed 240 °C
- However for lead free soldering, a maximum temperature of 255 °C for no more than 20 seconds is permitted.
- The antenna should not be exposed to temperatures exceeding 120 °C more than 3 times during the soldering process.

## 15. Hazardous Material Regulation Conformance

The antenna has been tested to conform to RoHS requirements. A certificate of conformance is available from Antenova's website.

## 16. Packaging

### 16.1 Optimal Storage Conditions

Temperature	-10°C to 40°C
Humidity	Less than 75% RH
Shelf life	24 Months
Storage place	Away from corrosive gas and direct sunlight
Packaging	Reels should be stored in unopened sealed manufacturer's plastic packaging.

**Note: Storage of open reels of antennas is not recommended due to possible oxidization of pads on antennas. If short term storage is necessary, then it is highly recommended that the bag containing the antenna reel is re-sealed and stored in like storage conditions as in above table.**

## 16.2 Tape Characteristics

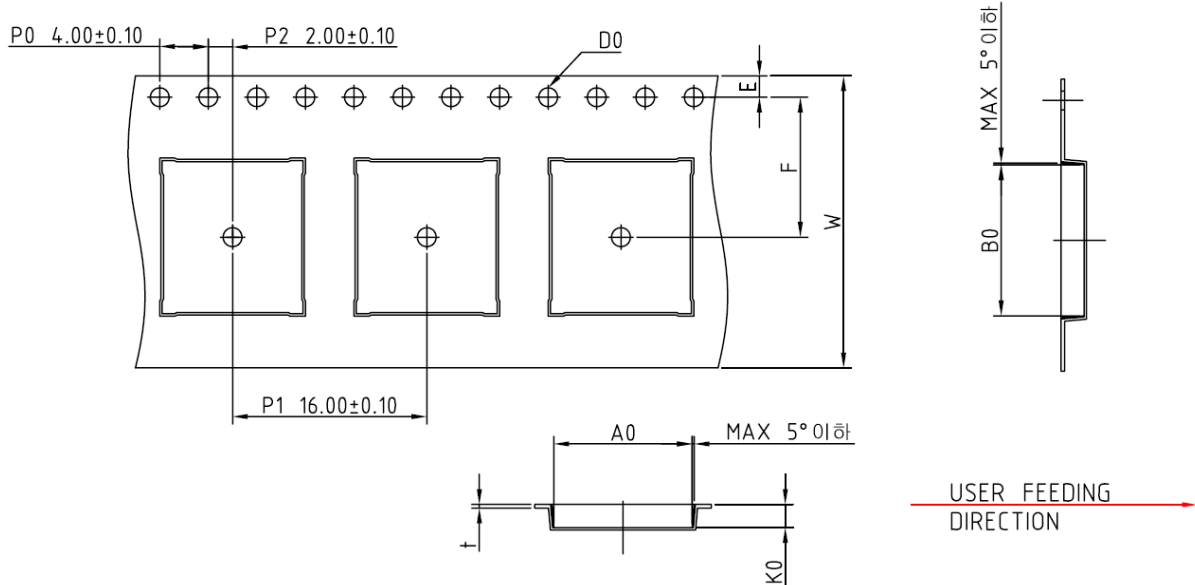

Ko	Ao	Bo	P0	P1	P2
1.90	11.40 ± 0.1	12.40 ± 0.1	4.00 ± 0.1	16.00 ± 0.1	2.00 ± 0.1

E1	F	W
1.75 ± 0.1	11.5 ± 0.15	24.00 ± 0.3

Dimensions in mm

### Notes:

- 1) 10 sprocket hole pitch cumulative tolerance  $\pm 0.2\text{mm}$ .
- 2) Camber not to exceed 1mm in 100mm.
- 3) Ao and Bo measured on a plane 0.1mm above the bottom of the packet.
- 4) Ko measured from a plane on the inside bottom of the packet to the top surface carrier.

### 16.3 Reel Dimensions

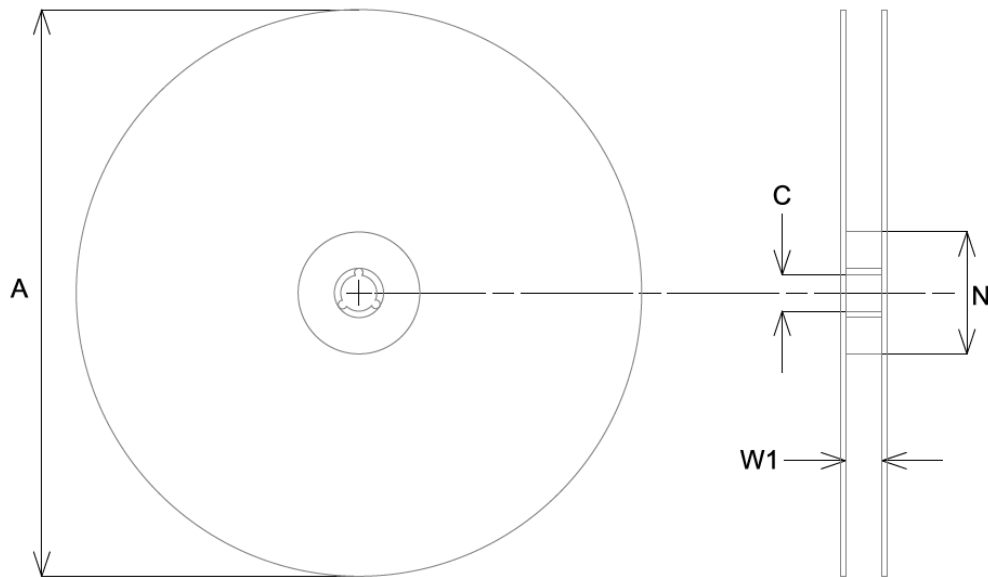

A	C	N	W1
330.0 ± 2.0	13.2 ± 0.5	178.0 ± 0.2	26.0 ± 0.3

All dimensions in mm

## 16.4 Box Dimensions

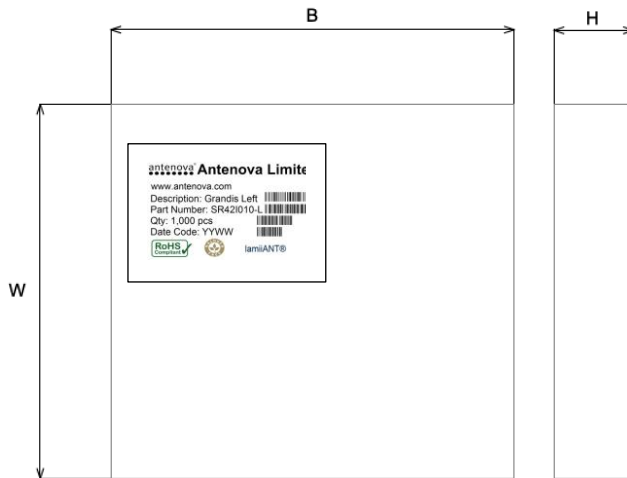

Width (W)	Breadth (B)	Thickness (H)
350mm	355mm	70mm

## 16.5 Bag Properties

Reels are supplied in protective plastic packaging.

## 16.6 Reel Label Information

