

DATASHEET

Sinica

SR4G008 · lamiiANT[®]



Features

- Antenna for 1559 – 1609 MHz, GNSS for embedded applications
- Solution for all global public constellations: GPS, GLONASS, Beidou and Galileo
- Maintains high performance on device: DFI (Designed For Integration)
- Ultra-flat compact design of only 0.4mm thickness
- Designed for SMD mounting
- Supplied on Tape and Reel

Contents

1.	Description	2
2.	Applications	2
3.	General data	2
4.	Part number	3
5.	RF characteristics	3
6.	RF performance	4
6.1.	Return loss	4
6.2.	VSWR	4
6.3.	Efficiency	5
6.4.	Antenna pattern	6
7.	Antenna dimensions	7
8.	Schematic symbol and pin definition	8
9.	Host PCB footprint	8
10.	Electrical interface	9
10.1.	Transmission line	9
10.2.	Matching circuit	9
11.	Antenna integration guide	10
11.1.	Antenna placement	10
11.2.	Host PCB layout	11
11.3.	Host PCB clearance	11
11.4.	Host PCB size	12
12.	Reference board	13
12.1.	Reference board matching circuit	13
13.	Soldering	14
14.	Hazardous material regulation conformance	14
15.	Packaging	14
15.1.	Optimal storage conditions	14
15.2.	Tape characteristics	15
15.3.	Reel dimensions	16
15.4.	Box dimensions	16
15.5.	Bag properties	17
15.6.	Reel label information	17

1. Description

Sinica is intended for use with all positioning applications. The antenna has RHCP characteristics suitable for GNSS signals. A truly novel antenna approach with ultra-low profile, but with the high performance of a ceramic patch.

2. Applications

- Trackers
- Portable devices
- Drones
- Telematics
- Wearable devices

3. General data

FREQUENCY	1559 – 1609 MHz
POLARIZATION	Linear
OPERATING TEMPERATURE	-40°C to 140°C
ENVIRONMENTAL CONDITION TEST	ISO16750-4 5.1.1.1/5.1.2.1/5.3.2
IMPEDANCE WITH MATCHING	50 Ω
WEIGHT	< 0.2g
ANTENNA TYPE	SMD
DIMENSIONS	7.0 x 5.8 x 0.4 (mm)

4. Part number

SINICA
SR4G008

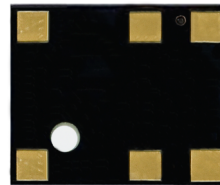

5. RF characteristics

	1559-1609MHZ
PEAK GAIN	1.5dBi
AVERAGE GAIN (LINEAR)	-2.1dBi
AVERAGE EFFICIENCY (LINEAR)	>60%
MAXIMUM RETURN LOSS	-12dB
MAXIMUM VSWR	1.4:1

All data measured on Antenna's evaluation PCB Part No. SR4G008-EVB-1

6. RF performance

6.1. Return loss

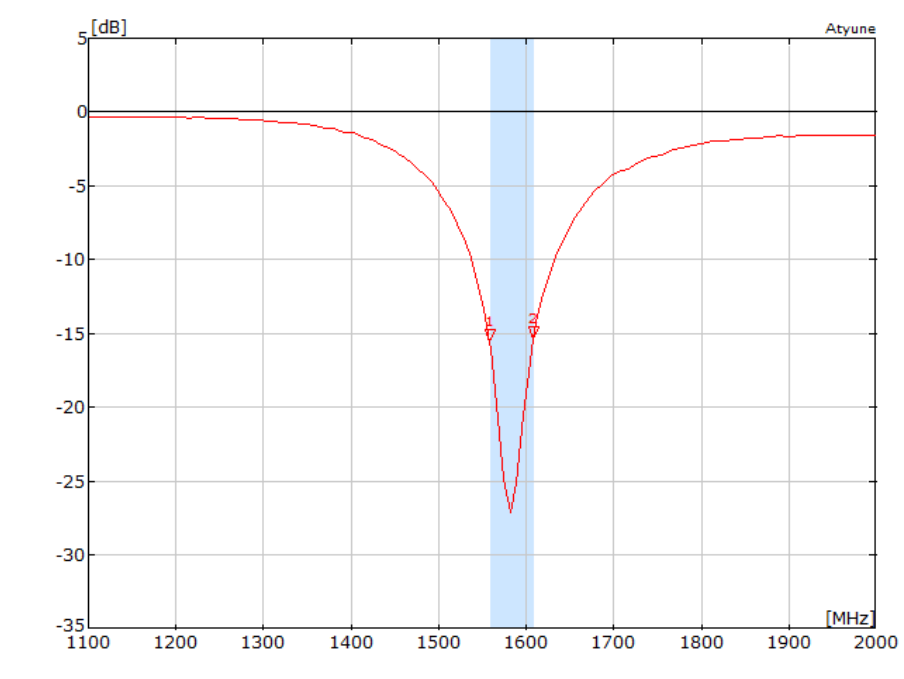

6.2. VSWR

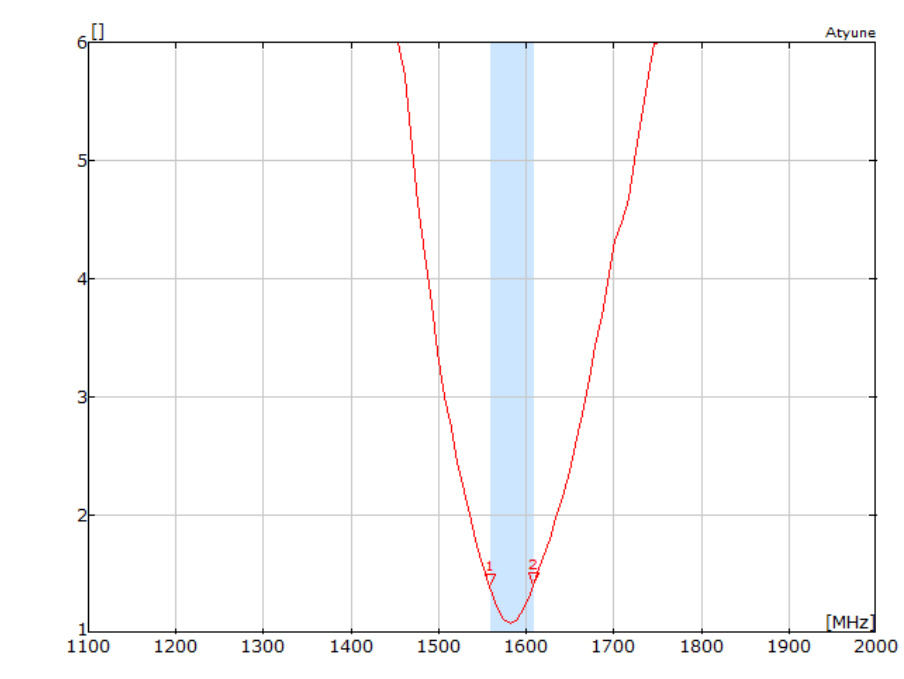

6.3. Efficiency

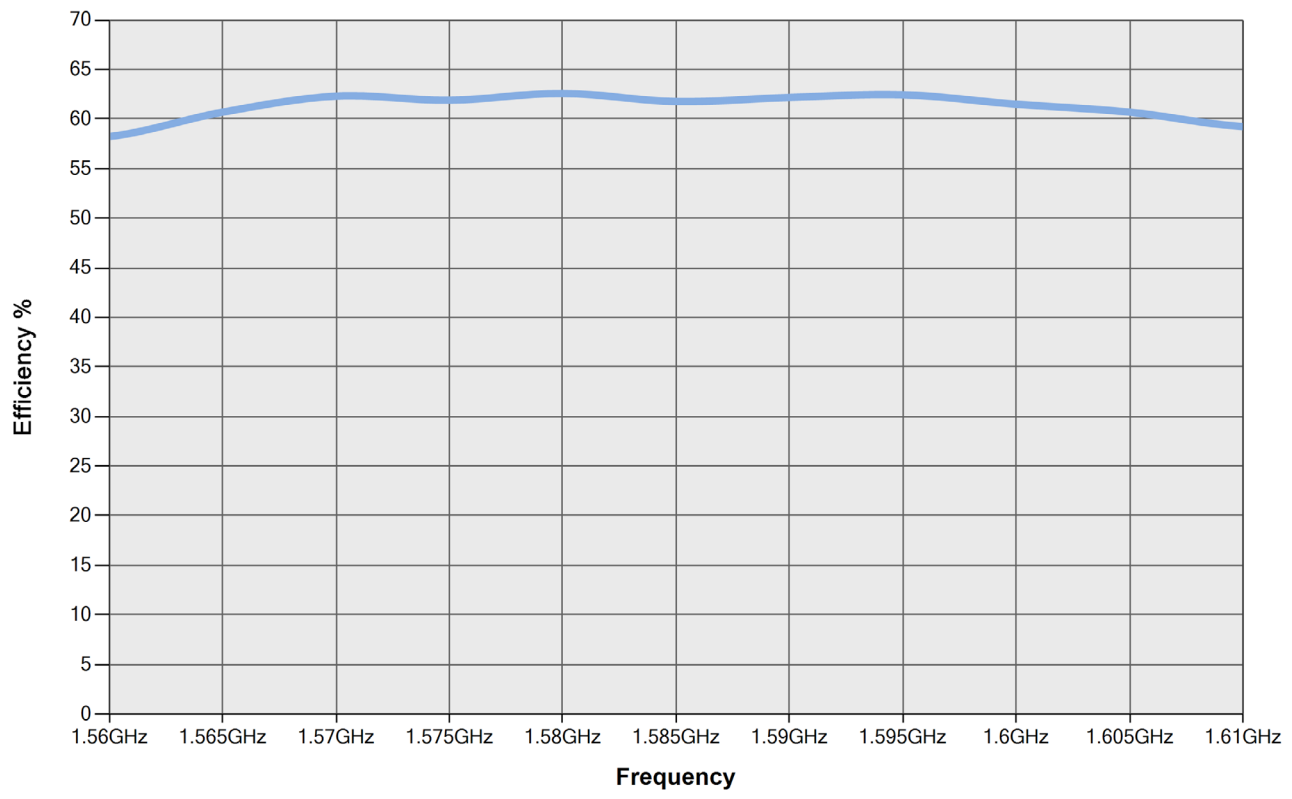

6.4. Antenna pattern

6.4.1. 159 MHz – 1609MHz

3D pattern at 1575MHz

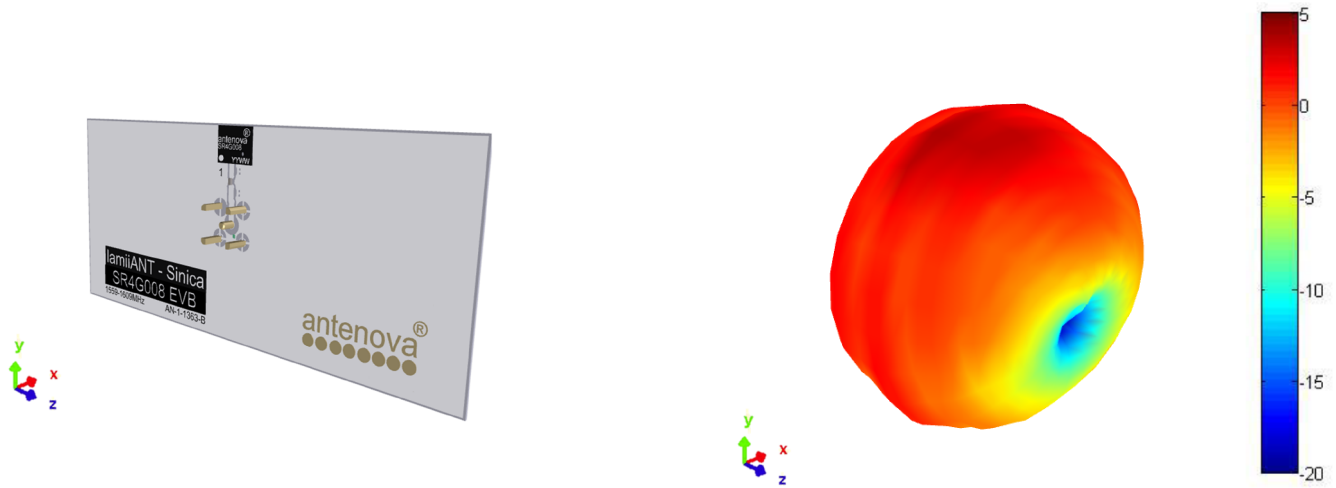

XY

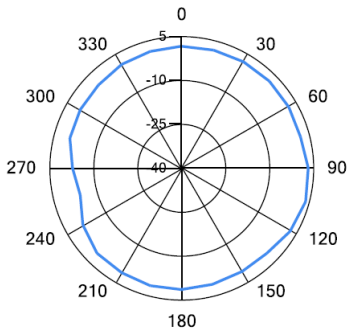

XZ

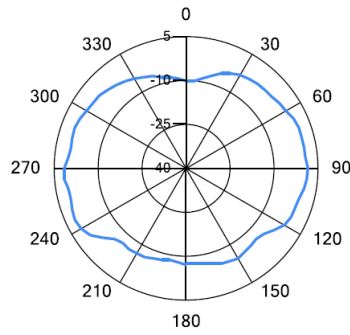

YZ

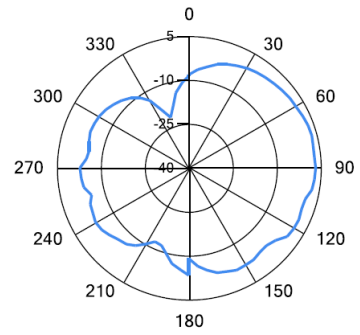

— 1.575GHz

7. Antenna dimensions

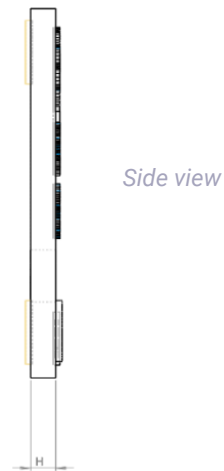

L	W	H
Length	Width	Height
7.0 ±0.1	5.8 ±0.1	0.4 ±0.2

All dimensions in (mm)

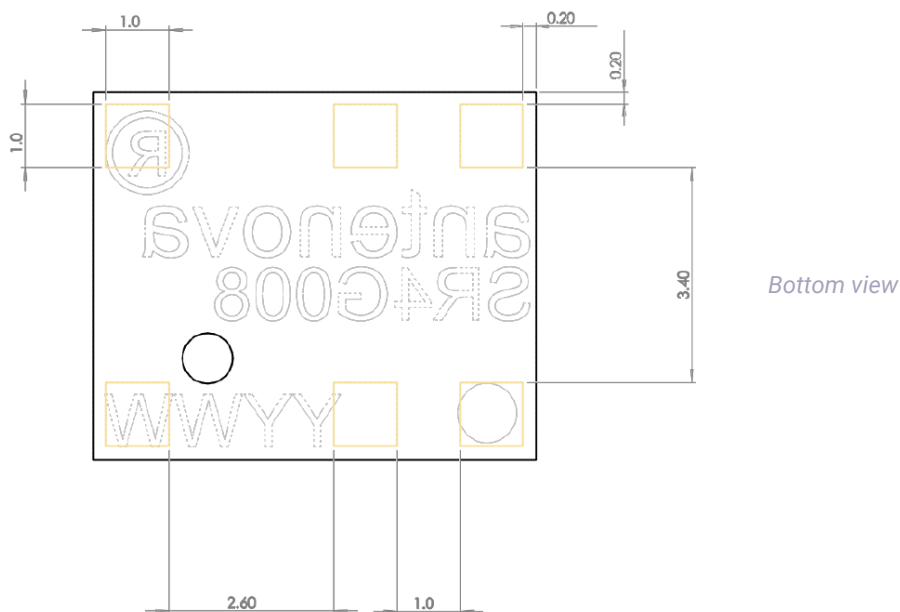

8. Schematic symbol and pin definition

The circuit symbol for the antenna is shown below. The antenna has 6 pins with only four as functional. All other pins are for mechanical strength.

PIN	DESCRIPTION
2	Feed (Transceiver port)
3, 4, 6	Return/GND
1, 5	NC (Not used, mechanical only)

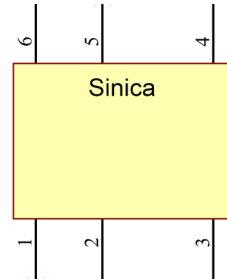

9. Host PCB footprint

The recommended host PCB footprint is below.

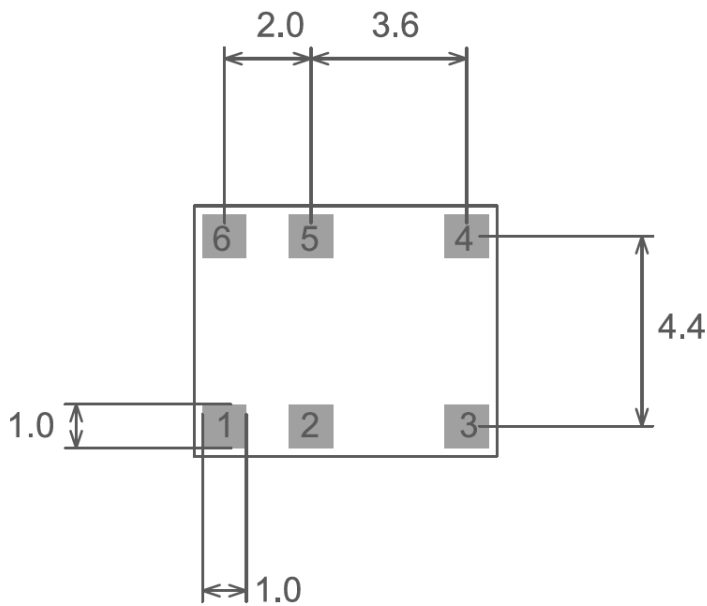

Pads 1-6 = 1.0 x 1.0 (mm)

10. Electrical interface

10.1. Transmission line

All transmission lines should be designed to have a characteristic impedance of 50Ω.

- The length of each transmission lines should be kept to a minimum
- All other parts of the RF system like transceivers, power amplifiers, etc, should also be designed to have a 50 Ω impedance

A co-planar transmission line can be designed using an online transmission line calculator tool, such as:

<https://blog.antenova.com/rf-transmission-line-calculator>

The PCB thickness, copper thickness and substrate dielectric constant are entered, then the tool calculates the transmission line width and gaps on either side of the track to give a 50 Ω impedance.

10.2. Matching circuit

The antenna requires a matching circuit that must be optimized for each product. The matching circuit will require up to three components and the following pad layout should be designed into the device so the correct circuit can be installed.

The Pi matching network must be placed close to the antenna feed to ensure it is more effective in tuning the antenna.

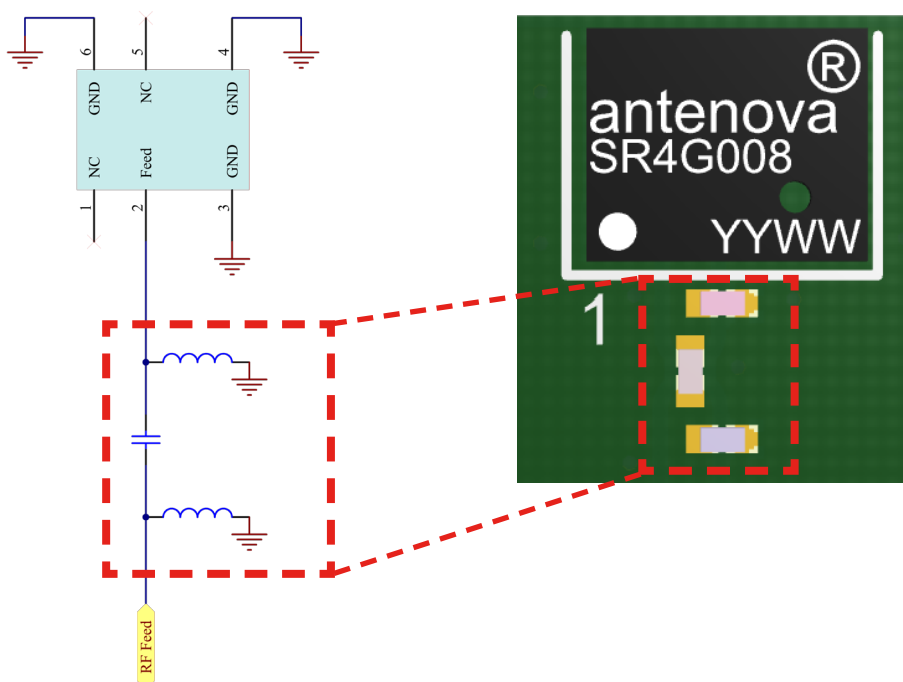

11. Antenna integration guide

We recommend the following during the design phase to maximise antenna performance and minimize noise:

- Minimum 4 layer PCB
- Route signals and power internally where possible
- Flood all layers with ground
- Knit ground on all layers together with plenty of vias

Follow placement guidance carefully, in addition Antenova provide technical support to help you through all stages of your design. Register for an account on <https://ask.antenova.com/> to access technical support.

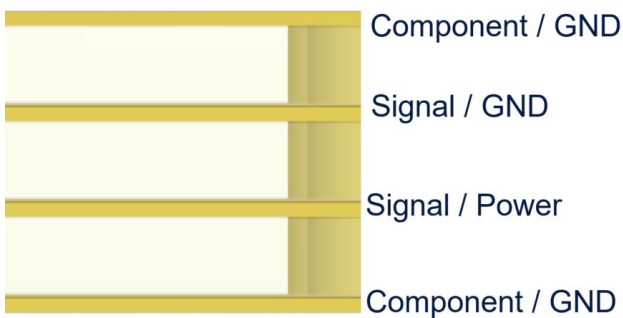

11.1. Antenna placement

The best position for the antenna is at the centre of the longest edge of the PCB.

Where the centre is not a viable option the antenna can be placed offset on the PCB to within the limits shown below. A minimum of 5mm from either PCB edge should be observed. Where possible this distance should be greater than 5mm.

The Antenova placement tool can be used to advise on antenna placement, see: <https://blog.antenova.com/intelligent-antenna-selection-and-placement-tool-antenova>

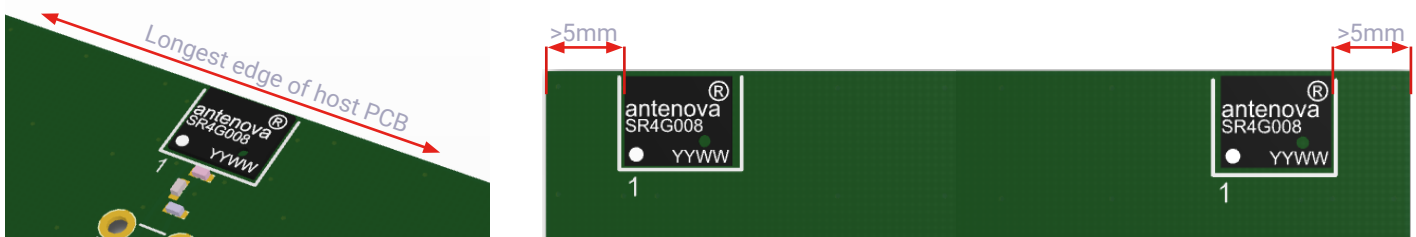

11.2. Host PCB layout

The host PCB must be designed using the PCB footprint shown with the correct clearances. An example of the PCB layout shows the antenna footprint. Please note this clearance area is critical to the performance of the antenna and must be applied through all layers of the PCB.

Pins 3, 4 and 6 (GND) are shown directly connecting to the GND with the shortest route. The feed (Pin 2) connects to the matching circuit close to the antenna.

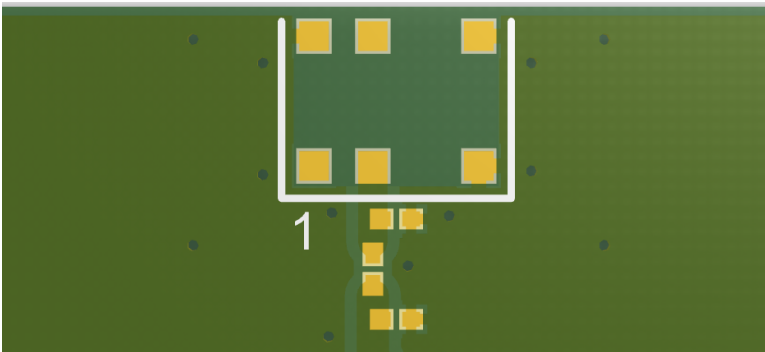

Example host layout

11.3. Host PCB clearance

Below shows the antenna footprint and clearance through all layers on the PCB. Only the antenna pads and connections to feed and GND are present within this clearance area. The clearance area required is 7.0 x 5.8 (mm).

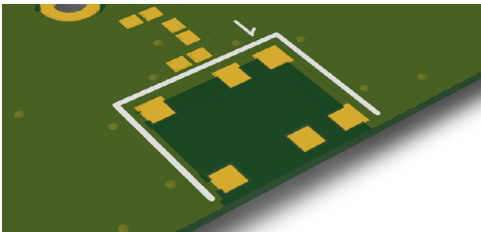

The clear-out area is simply defined as the same size as the antenna. No additional clearance is required.

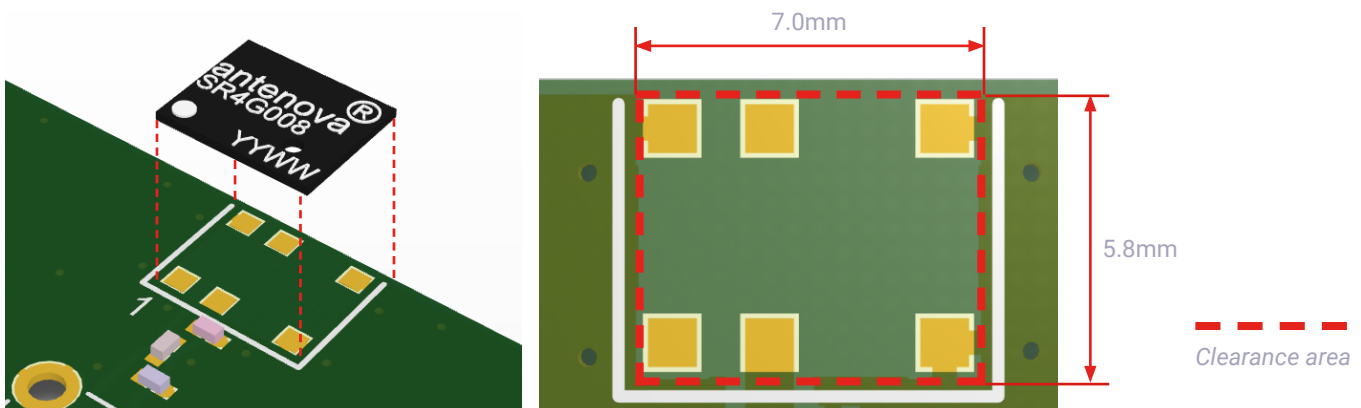

11.4. Host PCB size

The minimum recommended host PCB size to be used is 60 x 20 (mm). Below is the antenna performance vs PCB length.

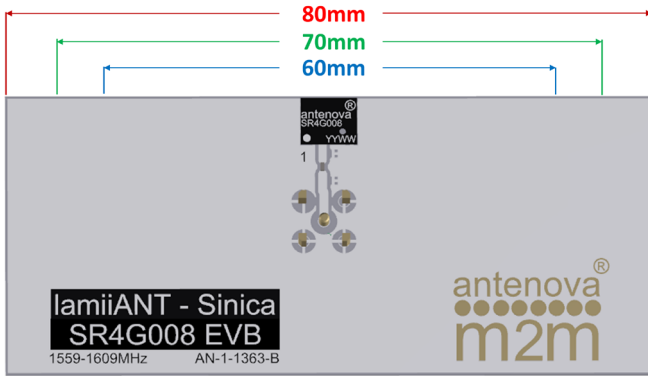

Passive Efficiency vs. PCB length.
All results measured in Antenova's anechoic chamber.

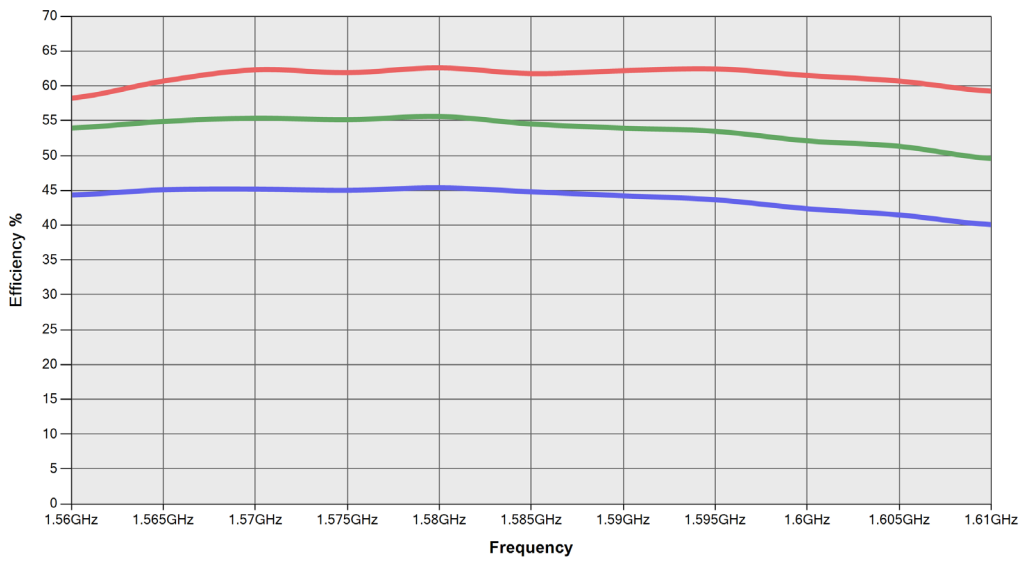

Sinica can also work well on the long edge of smaller PCBs, please contact techsupport@antenova.com for further information.

12. Reference board

A reference board is used for evaluating the antenna SR4G008 and it includes a SMA female connector. (Part number: SR4G008-EVB-1)

To order a reference board please see antenna.com

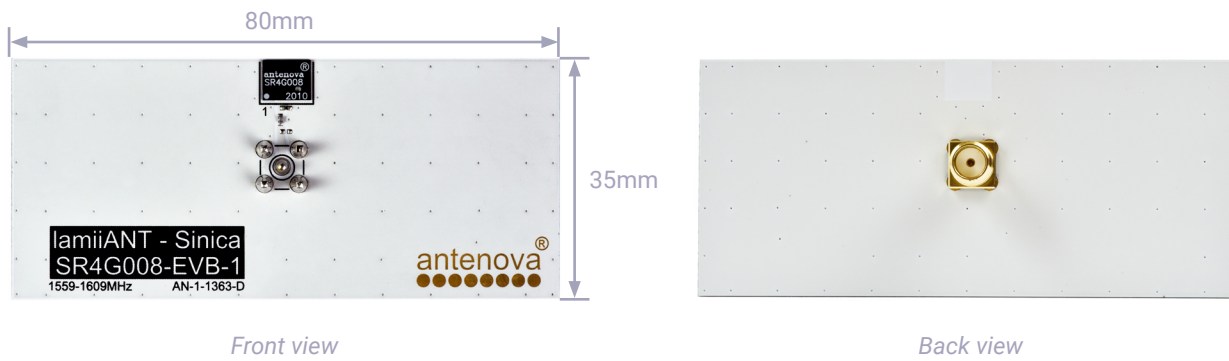

12.1. Reference board matching circuit

DESIGNATOR	TYPE	VALUE	DESCRIPTION
C1	Capacitor	1.5pF	Murata GJM15 series
L1	Inductor	Not fitted	Not fitted
L2	Inductor	12nH	Murata LQG15HN series

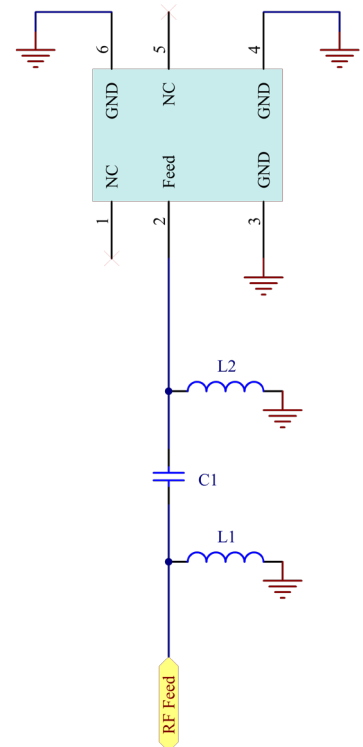

13. Soldering

This antenna is suitable for lead free soldering. The reflow profile should be adjusted to suit the device, oven and solder paste, while observing the following conditions:

- For leaded soldering, the maximum temperature should not exceed 240 °C.
- For lead free soldering, a maximum temperature of 255 °C for no more than 20 seconds is permitted.
- The antenna should not be exposed to temperatures exceeding 120 °C more than 3 times during the soldering process.

14. Hazardous material regulation conformance

The antenna has been tested to conform to RoHS and REACH requirements. A certificate of conformance is available from Antenova's website.

15. Packaging

15.1. Optimal storage conditions

TEMPERATURE	-10°C to 40°C
HUMIDITY	Less than 75% RH
SHELF LIFE	24 Months
STORAGE PLACE	Away from corrosive gas and direct sunlight
PACKAGING	Reels should be stored in unopened sealed manufacturer's plastic packaging.
MSL LEVEL	1

Note: Storage of open reels of antennas is not recommended due to possible oxidization of pads on antennas. If short term storage is necessary, then it is highly recommended that the bag containing the antenna reel is re-sealed and stored in conditions as described in the tabel above.

The shelf life of the antenna is 2 years provided the factory seal on the package has not been broken.

15.2. Tape characteristics

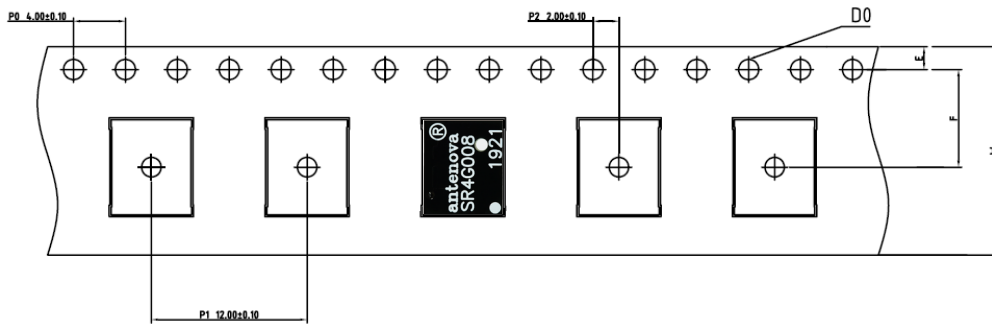

P0	P1	P2	D0
4.00 ± 0.1	12.00 ± 0.1	2.00 ± 0.1	1.55 ± 0.1

E	F	W
1.75 ± 0.1	7.50 ± 0.1	16.00 ± 0.3

All dimensions in (mm)

QUANTITY	LEADING SPACE	TRAILING SPACE
1000 pcs / reel	25 blank antenna holders	25 blank antenna holders

15.3. Reel dimensions

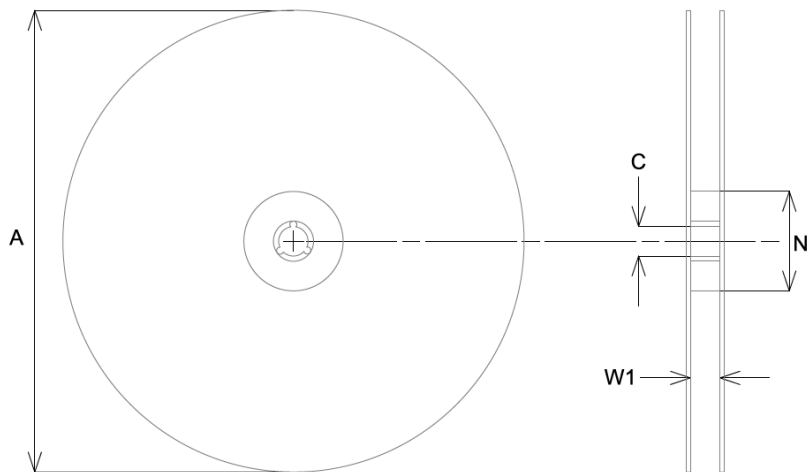

A	C	N	W1
178.0 ± 2.0	13.2 ± 0.5	60.0 ± 0.5	14.0 ± 0.3

All dimensions in (mm)

15.4. Box dimensions

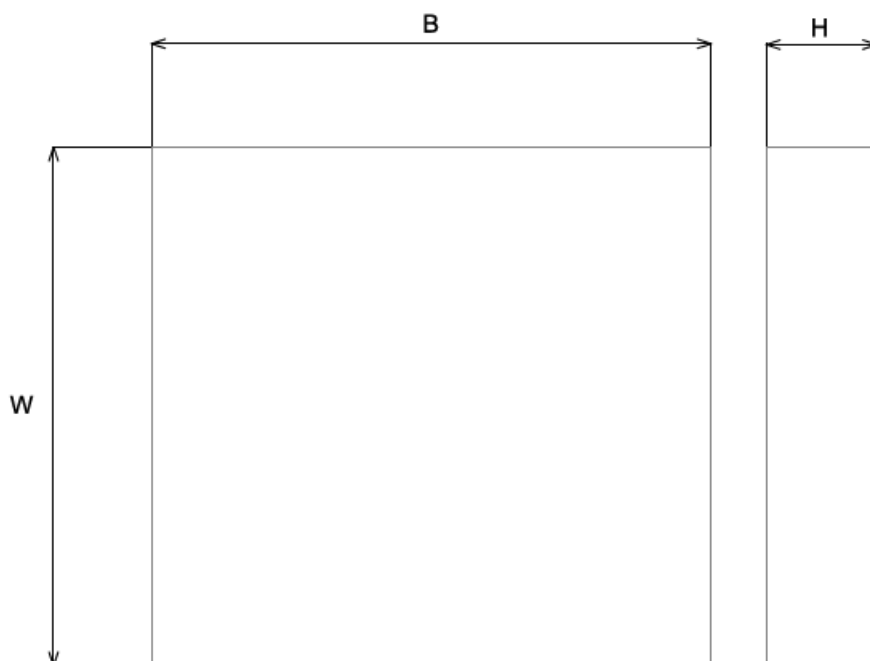

WIDTH (W)	BREADTH (B)	HEIGHT (H)
203mm	188mm	40mm

15.5. Bag properties

Reels are supplied in protective plastic packaging.

15.6. Reel label information



Quality statements

Antenova’s products conform to REACH and RoHS legislation. For our statements regarding these and other quality standards, please see antenova.com.

