

1. Features

- REFLECTOR Technology
- Antenna for GNSS applications
- GPS, GLONASS, Beidou and Galileo
- Maintains high performance within device: DFI (Designed For Integration)
- 1.13mm diameter RF cable with IPEX MHF connector
- Self-Adhesive mounted
- Quick integration minimizes design cycle
- High performance
- Available in 2 standard cable lengths

2. Description

The Robusta antenna is intended for use with all positioning applications. It is a rigid antenna with a cable that enables direct connection to the host device (Plastic/Metal/PCB). This antenna can be placed against any material and will not detune. It is designed for simple integration with plug and play simplicity. This product specification shows the performance of the antenna covering the frequency range: 1559 - 1609 MHz.

3. Applications

- Trackers
- Portable Devices
- Drones
- Wearable devices



Patent pending

4. Part Number

Robusta: **SR4G031-xxx**

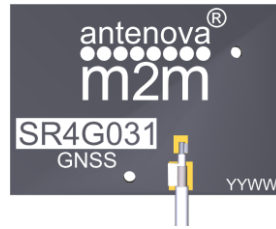

Note. -xxx refers to cable length option:

Part Number	Cable Length
SR4G031-100	100mm
SR4G031-150	150mm



5. General Data

Product name	Robusta
Part Number	SR4G031
Frequency	1559 – 1609 MHz
Polarization	Linear
Operating temperature	-40°C to +85°C
Environmental condition test	ISO 16750-4 5.1.1.1 / 5.1.2.1 / 5.3.2
Impedance with matching	50 Ω
Weight	< 0.5 g
Antenna Assembly type	FR4 Self-adhesive (3M 468MP)
Dimensions (Antenna)	23.0 x 16.0 x 1.6 (mm)
Cable length	100 / 150 (mm)
Connection	MHF IPEX

6. RF Characteristics

The RF characteristics are shown with the antenna placed in three scenarios:

- 1) **Placed on a metal surface (RF GND Plane)**
- 2) **In free space**
- 3) **Placed on a metal surface (Floating unconnected copper)**

	1559-1609MHz		
	Metal (RF GND)	Free space	Metal (Floating)
			
Peak gain	3.80dBi	2.45dBi	3.60dBi
Average gain	-3.00dBi	-2.45dBi	-3.00dBi
Average efficiency	>50%	>55%	>50%
Maximum return loss	<-11.0dB	<-13.0dB	<-13.0dB
Maximum VSWR	1.70:1	1.60 0:1	1.55:1

7. RF Performance

7.1 Return Loss

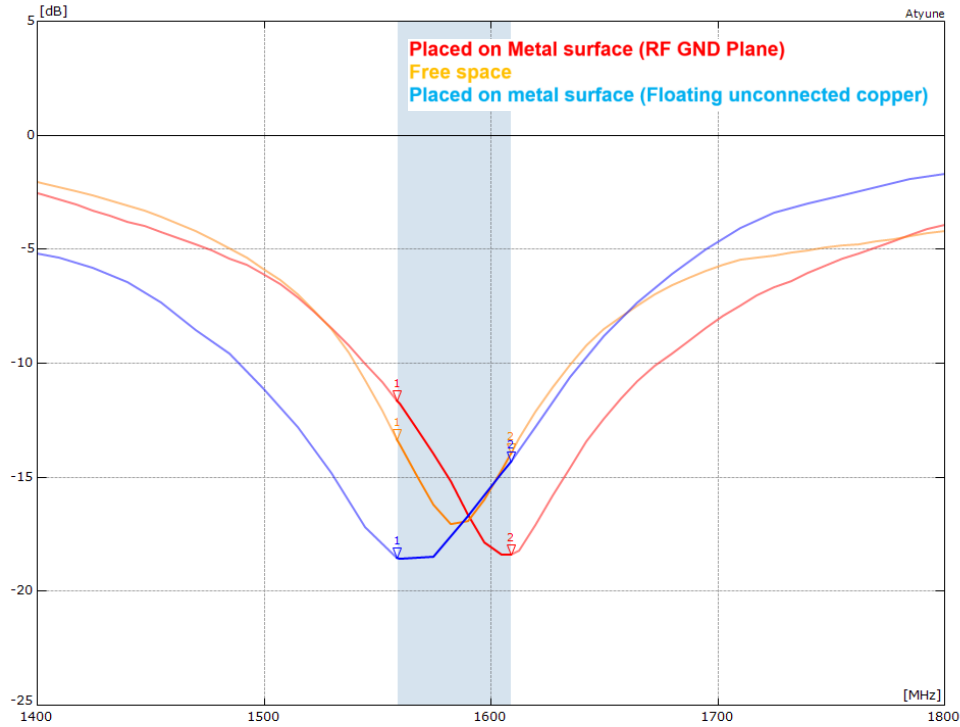

7.2 VSWR

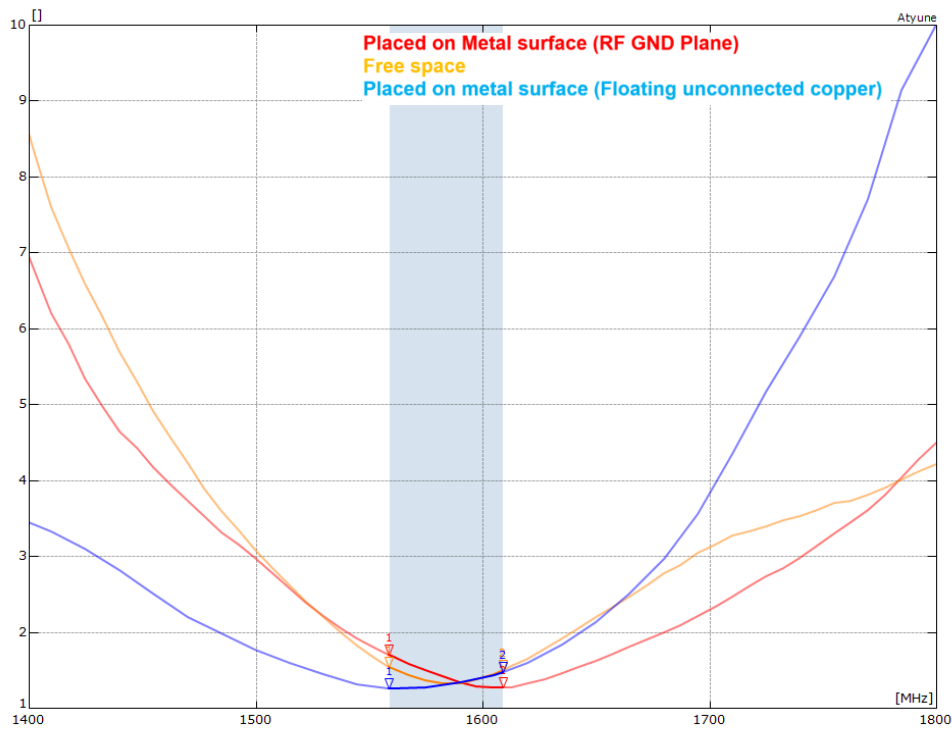

7.3 Antenna Pattern Free Space

7.3.1 1559 MHz – 1609 MHz

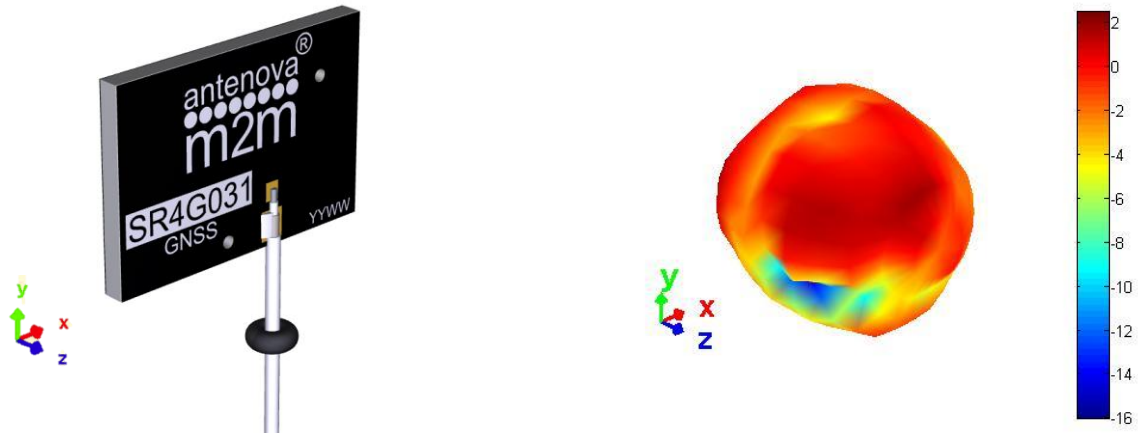

3D pattern at 1575.4 MHz
*Drag to rotate pattern and PCB by using Adobe Reader
(Click to Activate)*

XY

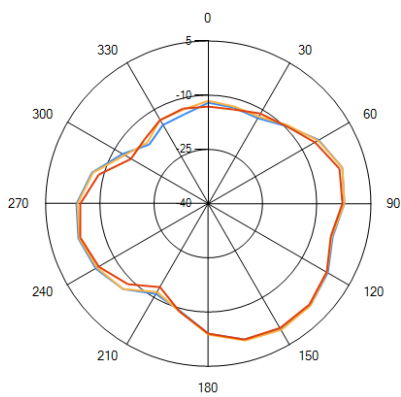

XZ

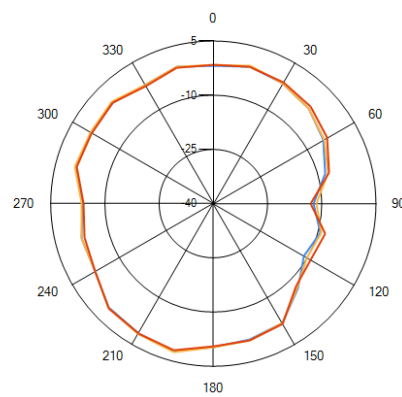

YZ

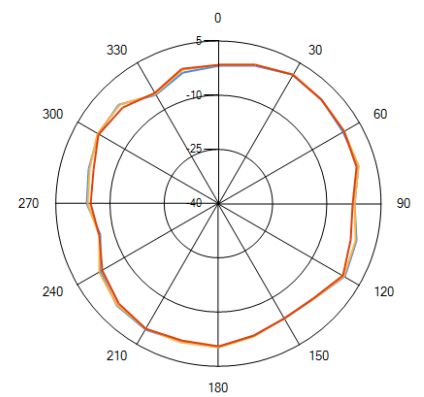

— 1.56GHz — 1.575GHz — 1.605GHz

8. Antenna Dimensions

8.1 Dimensions Antenna section

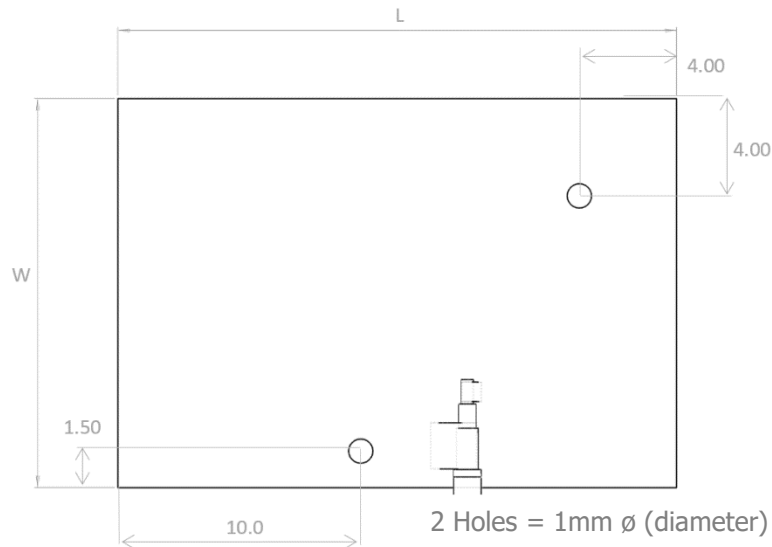

L	W	T
Length	Width	Thickness
23.0 \pm 0.2 (mm)	16.0 \pm 0.2 (mm)	1.6 (mm) nominal

All dimensions in mm

8.2 Dimensions assembled

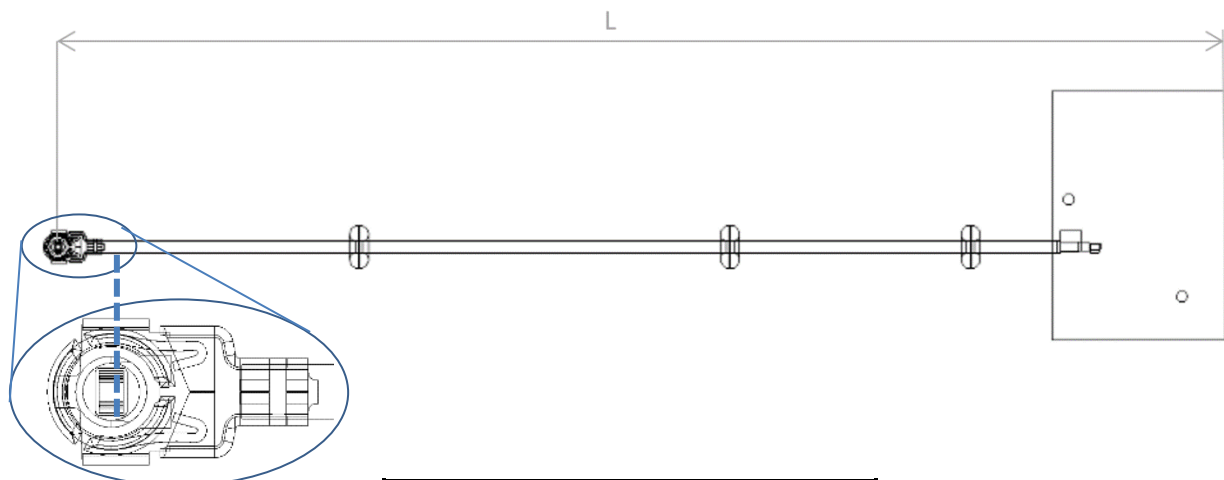

SR4G031-100	SR4G031-150
L	L
108 \pm 2.0 (mm)	158 \pm 2.0 (mm)

Antennas for Wireless Applications

8.3 IPEX Connector

I-PEX	
Material	Copper Alloy
Plating	Ag

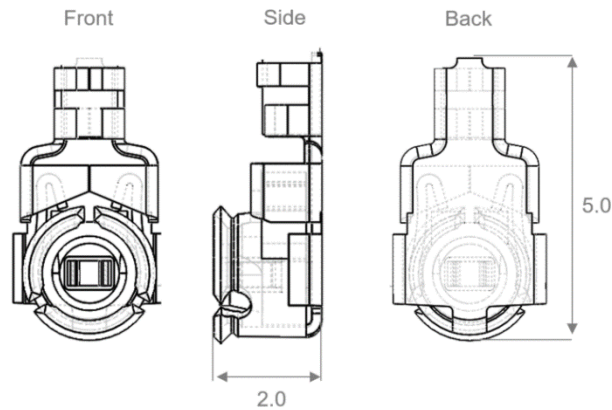

All dimensions in mm

8.4 O-Ring Spacer

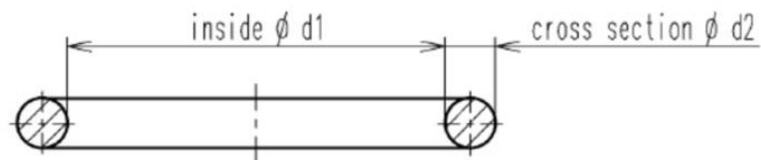

d1	d2
1.02 ±0.1	1.78 ±0.08

All dimensions in mm

8.5 Assembly

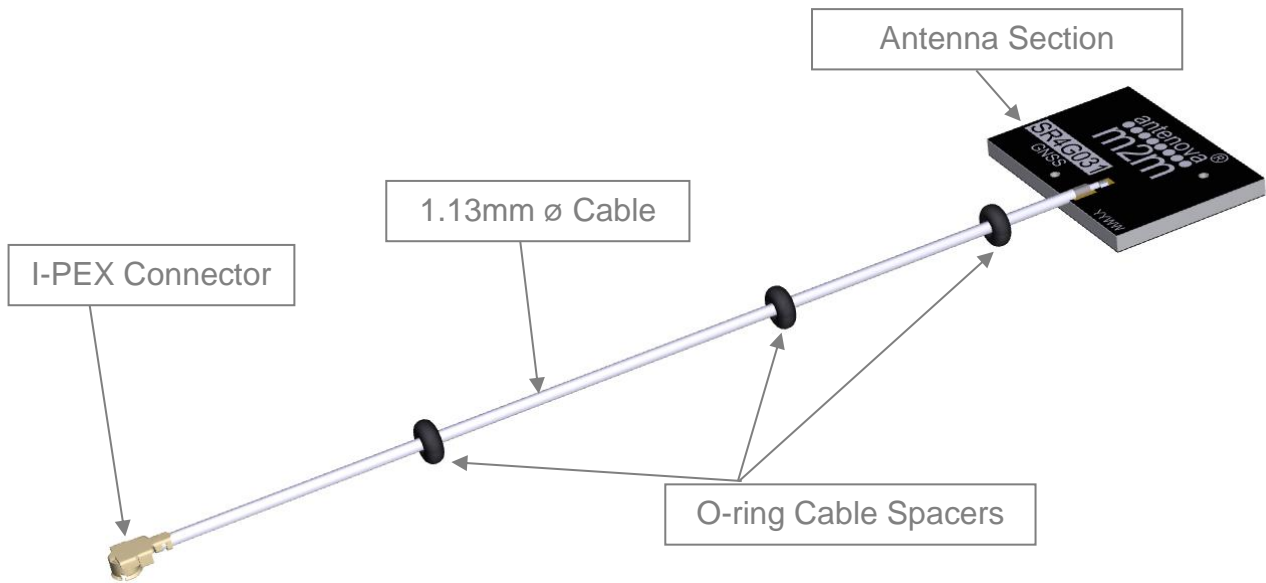

9. Electrical Interface

9.1 Host Interface

The host PCB requires the mating connector which is the IPEX MHF (UFL) receptacle. The location should be close to the chip/modules pin for the RF. Any feed from this receptacle should be maintained at 50Ω impedance.

9.2 Transmission Line

All transmission lines should be designed to have a characteristic impedance of 50Ω.

- The length of the transmission lines should be kept to a minimum.
- Any other parts of the RF system like transceivers, power amplifiers, etc, should also be designed to have an impedance of 50 Ω.

Once the material for the PCB has been chosen (PCB thickness and dielectric constant), a coplanar transmission line can easily be designed using any of the commercial software packages for transmission line design. For the chosen PCB thickness, copper thickness and substrate dielectric constant, the program will calculate the appropriate transmission line width and gaps on either side of the feed.

A DC blocking capacitor should be placed in line to protect the RF front end.

10. Mechanical Adhesion

The antenna uses 3M 468MP adhesive on the reverse side of the antenna section. It is designed for a one time fix to a clean smooth surface.

Antenna section reverse side

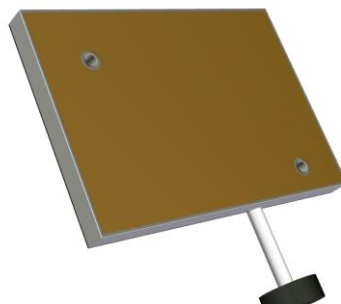

11.0 Antenna Integration Guide

11.1 Applied Surface Material

The antenna can be placed on any material and will radiate effectively in the direction away from the material. The performance will vary depending on the type of material or surface used. This antenna is intended for use internally within a device and this simply illustrates the versatility of the antenna.

The material behind the antenna is not critical, which enables it to be used in close proximity in devices that are thin, and it can be placed on a variety of surfaces.

Examples:

- Wall mounted devices.
- Mounting onto metal chassis (e.g. light switch chassis)
- Direct to host PCB
- Devices installed in places where the material is not defined or where it may be any of the above.



11.2 Placement

When placing the antenna within a device, the host PCB size is not a factor as with PCB mounted antennas. However, the placement still needs to follow some basic rules, as any antenna is sensitive to its environment.

The top side of the antenna must be clear of all obstructions that are electrically conductive.

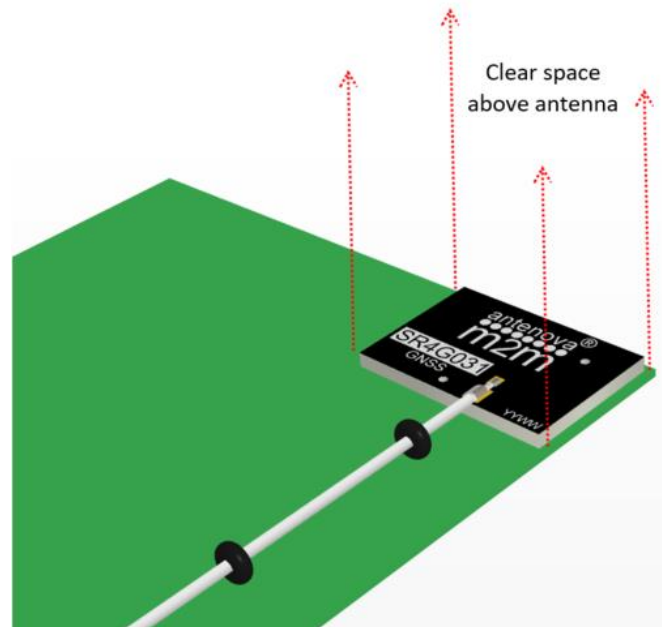

The location within the device should ideally be along any outer edge. The antenna can be in direct contact with any surface.

If the antenna is placed on a PCB, it should be kept a minimum distance away from any other board mounted component. This distance can be defined by projecting a 5° angle from the bottom of the antenna as shown below.

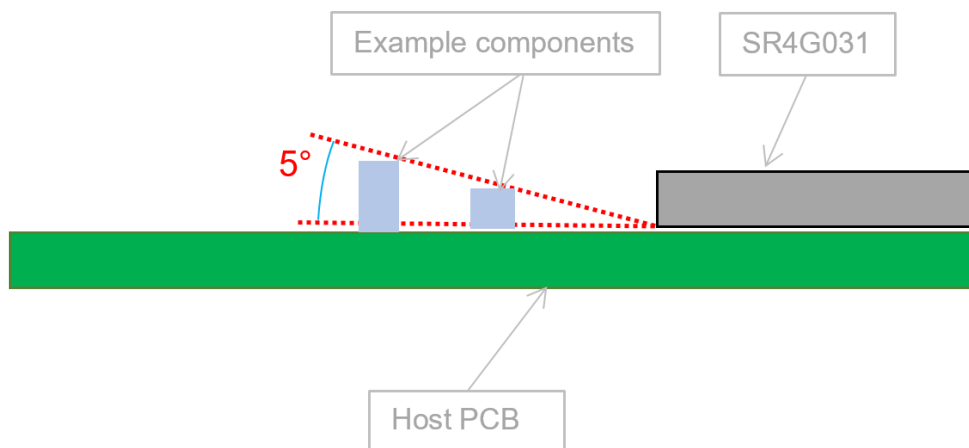

11.3 Cable Routing

The cable has three spacers for clearance and to prevent it from being in direct contact with any surface. The distance 'd' is defined by the O-ring ($d=1.78\text{mm}$).

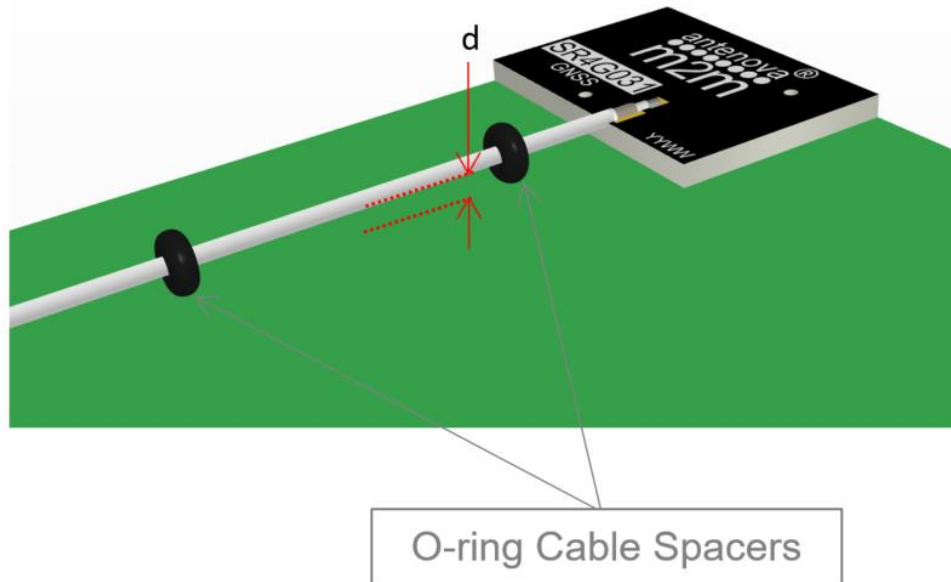

12. Hazardous Material Regulation Conformance

The antenna has been tested to conform to RoHS requirements. A certificate of conformance is available from Antenova's website.

13. Packaging

The antennas are stored in individual plastic (PE) bags. These are stored within a second bag of 100 pieces.

Single antenna per bag

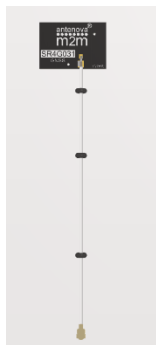

100 units per second bag (Labelled)

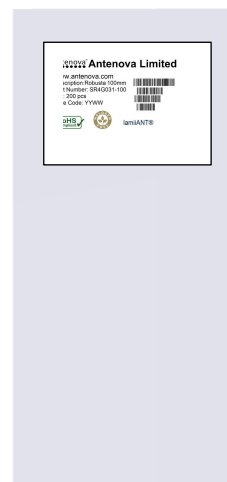

13.1 Optimal Storage Conditions

Temperature	-10°C to 40°C
Humidity	Less than 75% RH
Shelf life	18 Months
Storage place	Away from corrosive gas and direct sunlight
Packaging	Antennas should be stored in unopened sealed manufacturer's plastic packaging.

13.2 Label Information

