

DATASHEET

Agosti

SR4G080 • lamiiANT[®]



Features

- SMD Antenna for all GNSS constellations (1559 – 1609 MHz)
- GPS (L1), GLONASS (L1), Galileo (E1), BeiDou (B1), IRNSS & QZSS
- Evaluation board size: 70x25mm
- Minimum ground plane size: 40x20mm
- High efficiency, up to 67% on an 80x30mm groundplane
- Low Profile, Small size Antenna, dimensions: 9.0 x 5.8 x 1.7 mm
- Complies to Reach & RoHS standards

Contents

1.	Description	2
2.	Applications	2
3.	General data	2
4.	Part number	3
5.	RF characteristics	3
6.	RF performance	4
6.1.	Return loss	4
6.2.	VSWR	4
6.3.	Efficiency	5
6.4.	Antenna pattern	6
7.	Antenna dimensions	7
8.	Schematic symbol and pin definition	8
9.	Host PCB footprint	8
10.	Electrical interface	9
10.1.	Transmission line	9
10.2.	Matching circuit	9
11.	Antenna integration guide	10
11.1.	Antenna placement	10
11.2.	Host PCB layout	11
11.3.	Host PCB clearance	11
11.4.	Host PCB size	12
11.5.	Integration example	13
12.	Reference board	14
12.1.	Reference board matching circuit	14
13.	Soldering	15
14.	Hazardous material regulation conformance	15
15.	Packaging	15
15.1.	Optimal storage conditions	15
15.2.	Tape characteristics	16
15.3.	Reel dimensions	17
15.4.	Box dimensions	17
15.5.	Bag properties	18
15.6.	Reel label information	18

1. Description

Agosti is intended for use with all GNSS positioning applications. The antenna is omni-directional and is suited to small PCB sizes. It has an ultra-low profile, and comparable performance to a small ceramic patch on a small ground plane.

Agosti is designed to be placed in the left hand corner of a design, it should be placed on the shorter edge of a rectangular PCB. This is different to the Sinica antenna that should be placed on the long edge of a PCB.

2. Applications

- Wearables such as Fitness monitors
- Trackers such as Pet trackers & Bike trackers
- Asset tracking devices
- UAVs / Drones
- Robotics
- Telematics devices

3. General data

FREQUENCY	1559-1609MHz
POLARIZATION	Linear
OPERATING TEMPERATURE	-40°C to 140°C
ENVIRONMENTAL CONDITION TEST	ISO16750-4 5.1.1.1/5.1.2.1/5.3.2
IMPEDANCE WITH MATCHING	50 Ω
WEIGHT	<0.2g
ANTENNA TYPE	SMD
DIMENSIONS	9.0 x 5.8 x 1.7 (mm)

4. Part number

AGOSTI
SR4G080

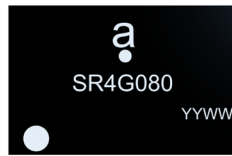

5. RF characteristics

All data measured on Antenna's evaluation PCB Part No. SR4G080EVB-1 (EVK size 70mm x 25mm)

	1559-1609MHZ
PEAK GAIN	0.7dBi
AVERAGE GAIN (LINEAR)	-2.97dBi
AVERAGE EFFICIENCY	>50%
MAXIMUM RETURN LOSS	-6.3dB
MAXIMUM VSWR	2.8:1

6. RF performance

6.1. Return loss

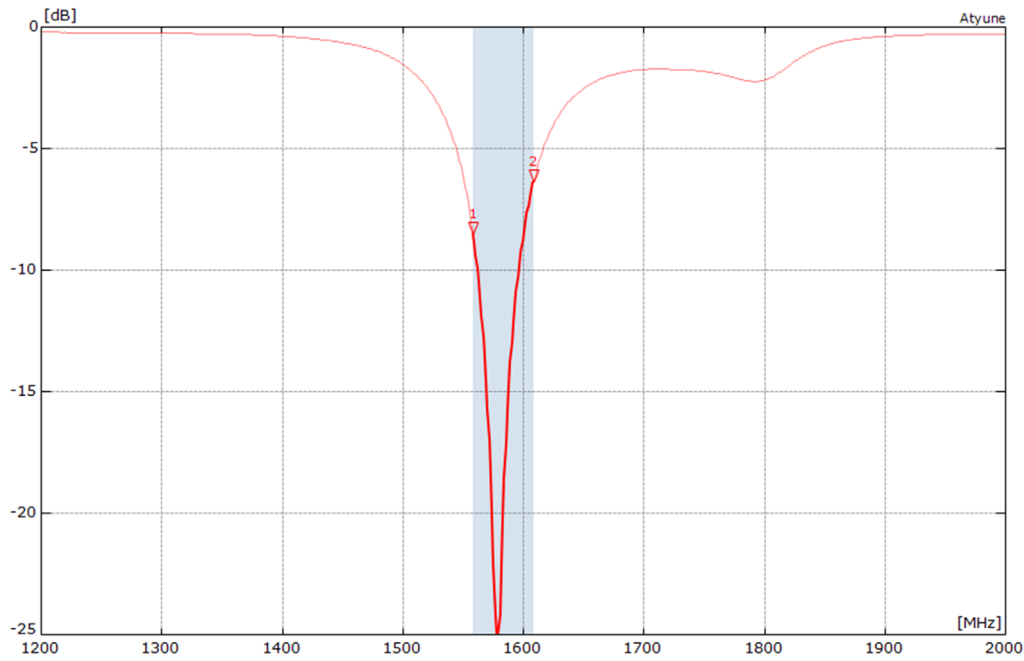

All data measured on Antenna's evaluation PCB Part No. SR4G080EVB-1 (EVK size 70mm x 25mm)

6.2. VSWR

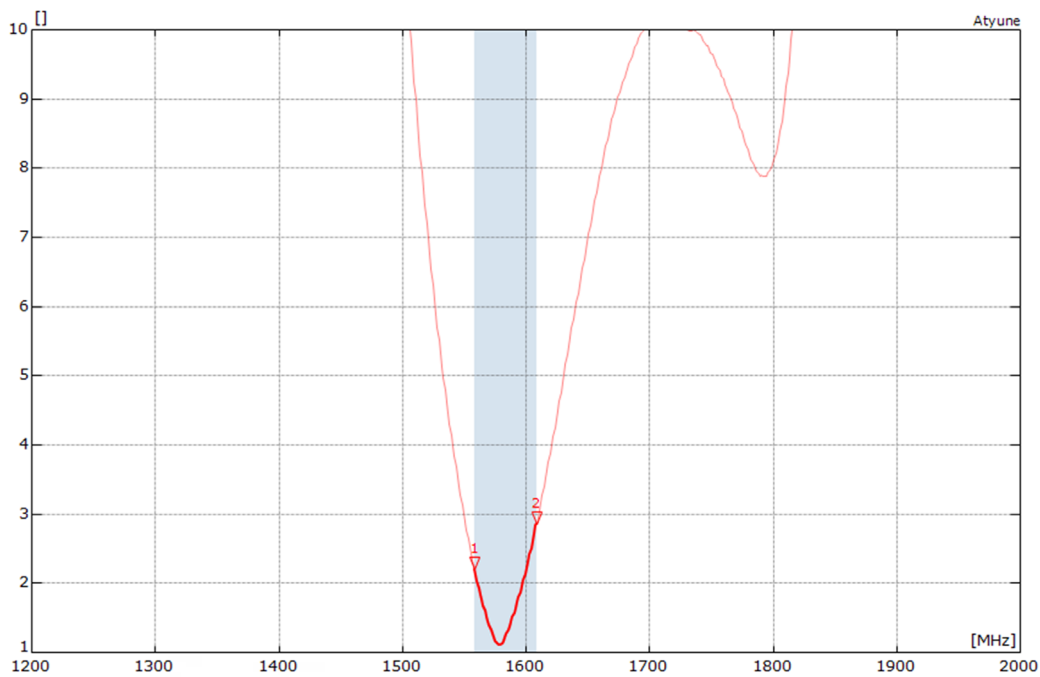

All data measured on Antenna's evaluation PCB Part No. SR4G080EVB-1 (EVK size 70mm x 25mm)

6.3. Efficiency

All data measured on Antenova's evaluation PCB Part No. SR4G080EVB-1 (EVK size 70mm x 25mm)

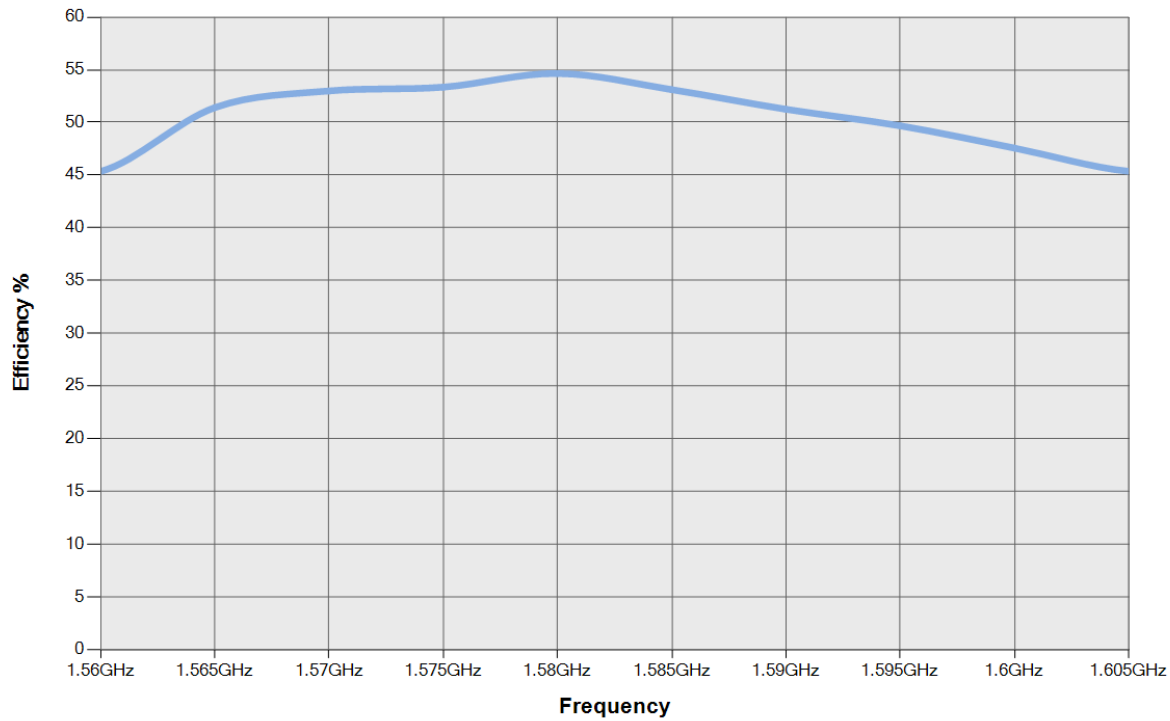

6.4. Antenna pattern

6.4.1. 1559-1609MHz

3D pattern at 1575MHz

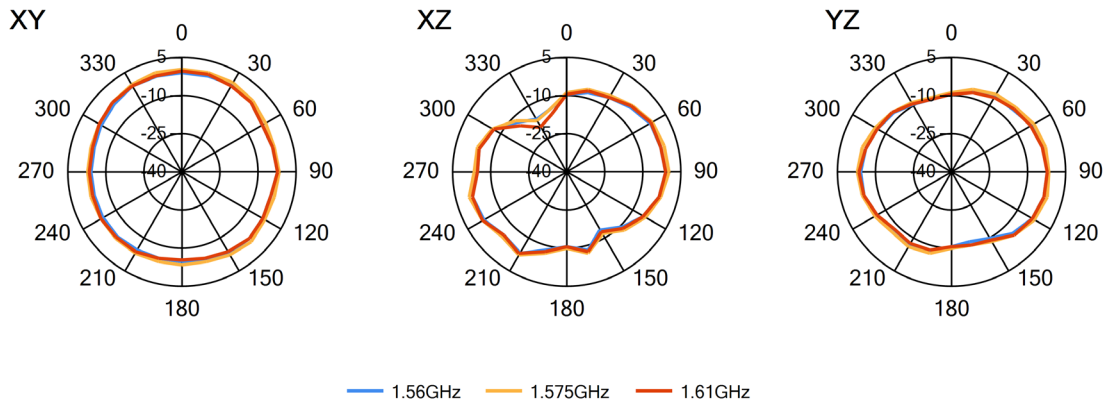
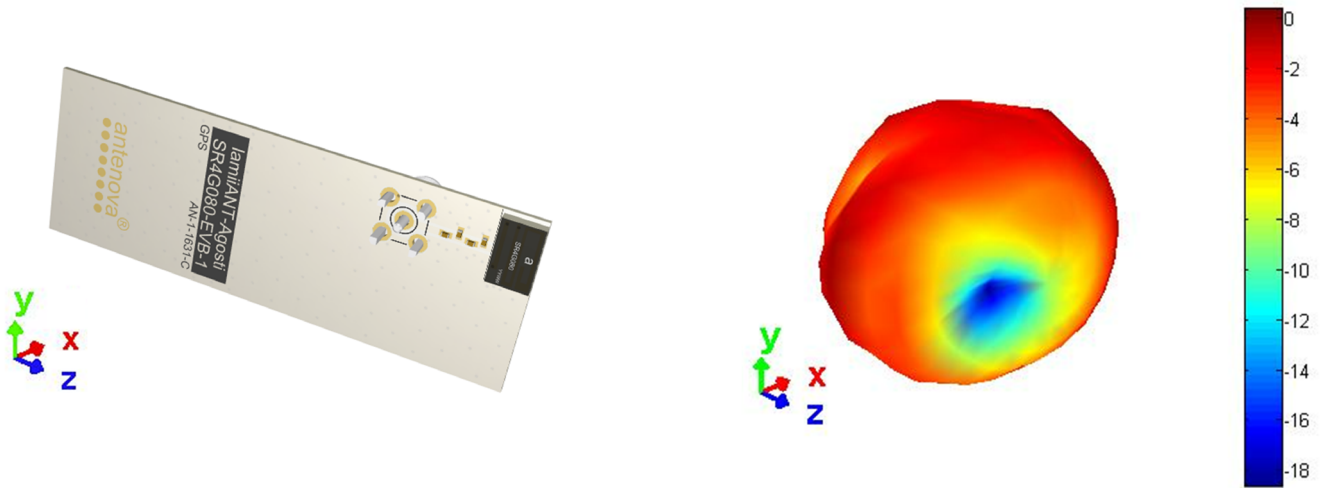

7. Antenna dimensions

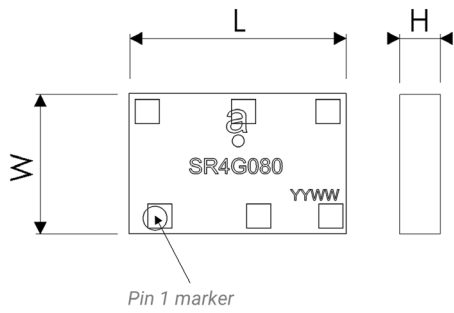

Top view

L	W	H
Length	Width	Height
9.0 ±0.1	5.8 ±0.1	1.7 ±0.1

All dimensions in (mm)

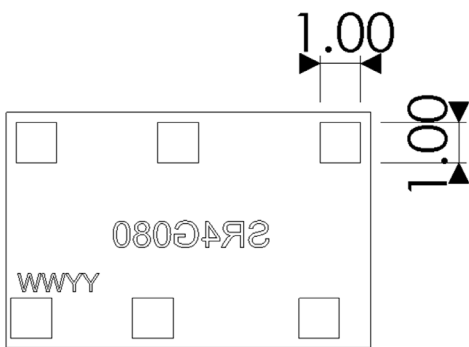

Bottom view

8. Schematic symbol and pin definition

The circuit symbol for the antenna is shown below. The antenna has 6 pins with only 2 as functional. All other pins are for mechanical strength.

PIN	DESCRIPTION
2	Feed (Transceiver port)
3	Return/GND
1, 4, 5, 6	NC (Not used, mechanical only)

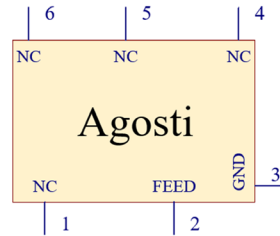

9. Host PCB footprint

The recommended host PCB footprint is below.

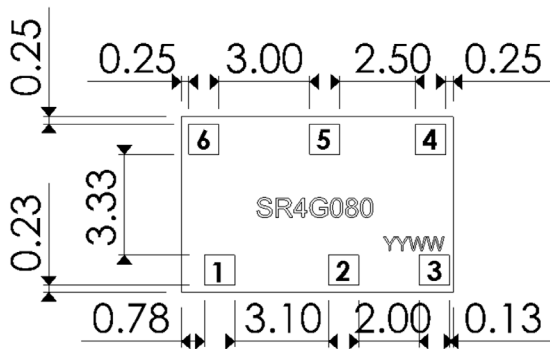

Pads 1-6 = 1.0 x 1.0 (mm)

10. Electrical interface

10.1. Transmission line

All transmission lines should be designed to have a characteristic impedance of 50Ω.

- The length of each transmission lines should be kept to a minimum
- All other parts of the RF system like transceivers, power amplifiers, etc, should also be designed to have a 50 Ω impedance

A co-planar transmission line can be designed using an online transmission line calculator tool, such as:

<https://blog.antenova.com/rf-transmission-line-calculator>

The PCB thickness, copper thickness and substrate dielectric constant are entered, then the tool calculates the transmission line width and gaps on either side of the track to give a 50 Ω impedance.

10.2. Matching circuit

The antenna requires a matching circuit that must be optimized for each product. The matching circuit will require up to four components and the following circuit should be designed into the host PCB. Not all components may be required but should be included as a precaution. The matching network should be placed close to the antenna feed to ensure it is optionally effective in tuning the antenna.

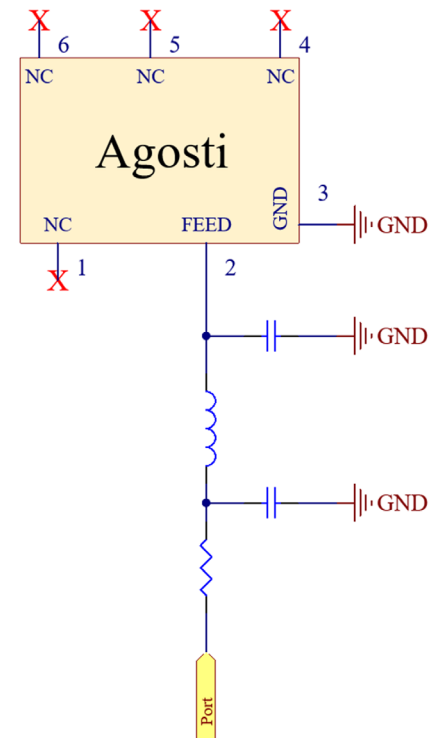

11. Antenna integration guide

We recommend the following during the design phase to maximise antenna performance and minimize noise:

- Minimum 4 layer PCB
- Route signals and power internally where possible
- Flood all layers with ground
- Knit ground on all layers together with plenty of vias

Follow placement guidance carefully. Antenova provide technical support to help you with your design, and also provide design assistance on PTCRB certification. Register for an account on <https://ask.antenova.com/> to access technical support.

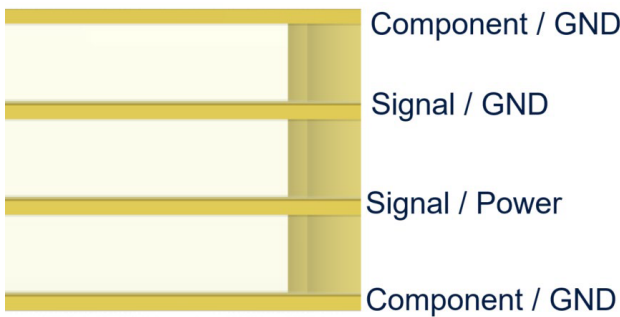

11.1. Antenna placement

The best position for the antenna is in the corner of the short side of the PCB. This allows the longer side of the PCB to be a ground plane, a long ground plane improves the antenna's efficiency. The antenna requires clearance ideally in 5 spatial directions as shown below. Where this cannot be achieved you should keep as many clear as possible to a minimum of 3. Please note performance will degrade with fewer clearances.

The Antenova placement tool can be used to advise on antenna placement, see: <https://blog.antenova.com/intelligent-antenna-selection-and-placement-tool-antenova>

Correct



Incorrect

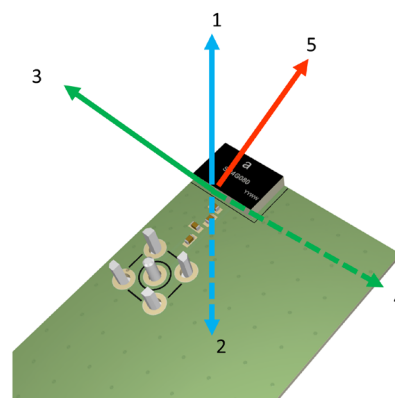

11.2. Host PCB layout

The host PCB must be designed using the PCB footprint shown with the correct clearances. An example of the PCB layout shows the antenna footprint. Please note this clearance area is critical to the performance of the antenna and must be applied through all layers of the PCB.

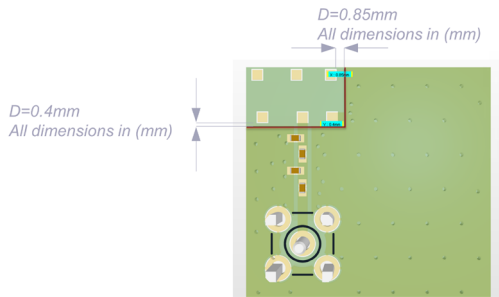

All dimensions in (mm)

11.3. Host PCB clearance

The diagram below shows the antenna footprint and clearance through all layers on the PCB. Only the antenna pads and connections to feed and GND are present within this clearance area.

Placement of components and GND with traces adjacent to the antenna should maintain a minimum clearance of 10mm x 6mm. The antenna should therefore be placed in the corner to only have one side affected.

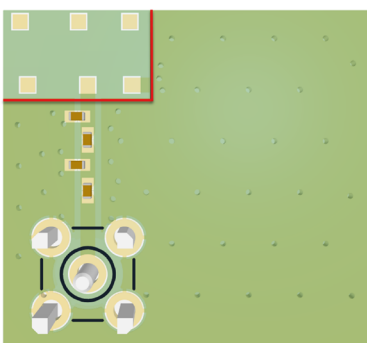
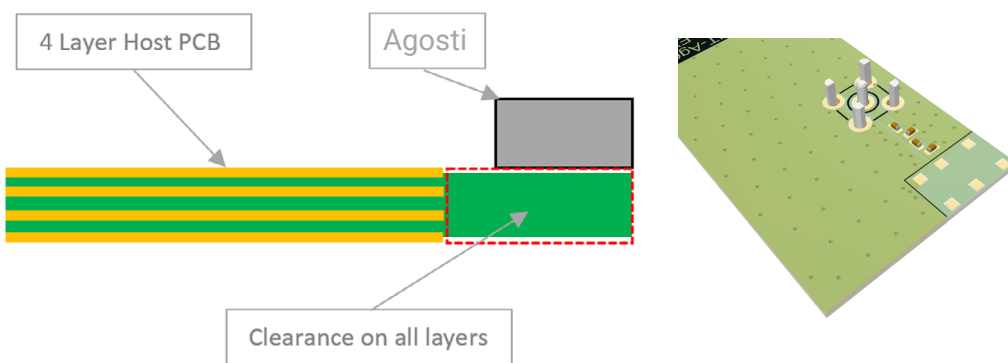

11.4. Host PCB size

As with all Antenova SMD antennas Agosti requires the ground plane of the PCB in order to radiate effectively. To illustrate this the Agosti antenna was used with the Antenova M10578-A2 module for active 'open sky' testing on various PCB lengths.

70X25MM (EVB)	TIME TO FIRST FIX (S)	AVG 4 SV (CN)	PEAK (CN)	NO. FIXED SV
Test 1	30	43	44	11
Test 2	25	42.5	44	11
Test 3	25	43	45	11

60X25MM	TIME TO FIRST FIX (S)	AVG 4 SV (CN)	PEAK (CN)	NO. FIXED SV
Test 1	25	43	45	10
Test 2	25	42.5	43	11
Test 3	30	43	43	11

50X25MM	TIME TO FIRST FIX (S)	AVG 4 SV (CN)	PEAK (CN)	NO. FIXED SV
Test 1	30	41	42	11
Test 2	35	41.5	43	11
Test 3	30	41	42	11

40X25MM	TIME TO FIRST FIX (S)	AVG 4 SV (CN)	PEAK (CN)	NO. FIXED SV
Test 1	30	39	39	10
Test 2	30	39	40	10
Test 3	30	39	39	10

All data measured with Agosti SR4G080-EVB-1 & M20048-EVB-1

11.5. Integration example

Agosti was integrated on a 65x42mm PCB with OBD connector, along with Antenova Pharaoh LTE antenna. Agosti was measured with Antenova M10578-A2 module for active 'open sky' testing. Pharaoh passive efficiency was measured in an anechoic chamber and isolation was measured on a VNA.

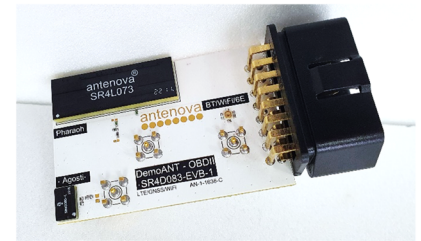

OBDII Device – Cat M1

AGOSTI	TIME TO FIRST FIX (S)	AVG 4 SV (CN)	PEAK (CN)	NO. FIXED SV
Test 1	30	41	42	11
Test 2	25	41	42	12
Test 3	25	41	42	10

All data measured with M20048-EVB-1

PHARAOH	698-960MHZ	1710-2170MHZ	2300-2400MHZ	2500-2690MHZ
Efficiency(min)	20%	35%	35%	45%
Efficiency(avg)	30%	60%	50%	65%
Gain(peak)	-1.1dBi	3.2dBi	3.3dBi	2.2dBi
Gain(avg)	-5.6dBi	-2.3dBi	-3.2dBi	-3.2dBi

Agosti-Pharaoh ISOLATION

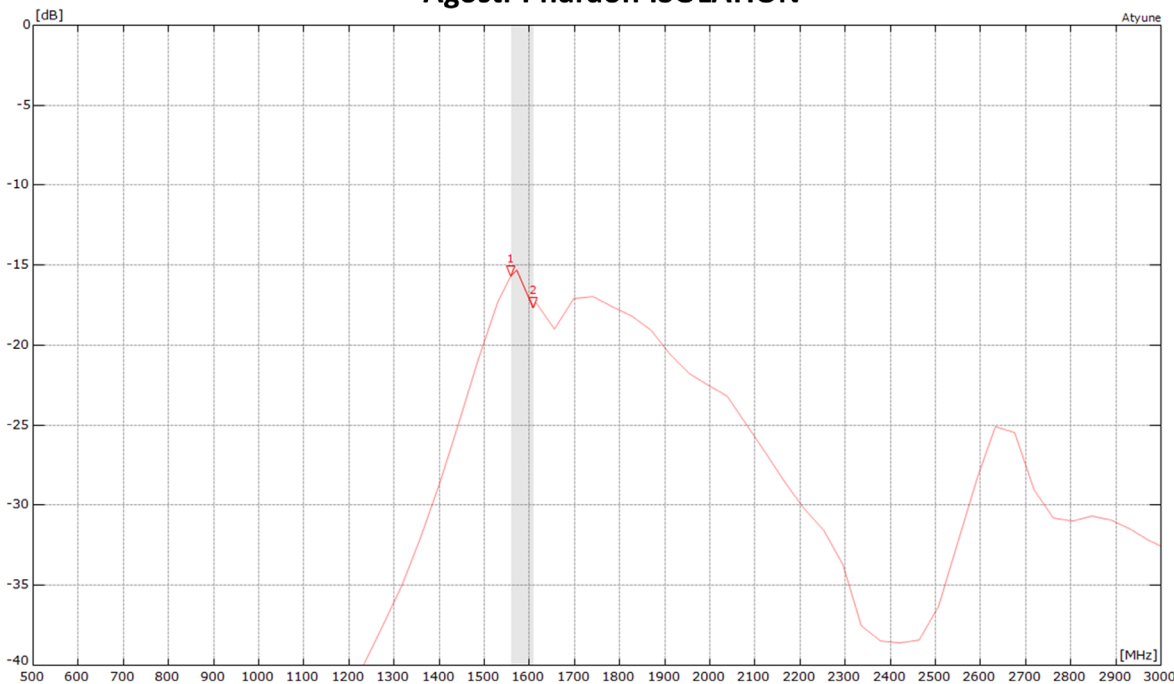

MARKERS:	MHz	dB
RD8083 AGOSTI PHARAOH ISOLATION.S2P - S21		
1:	1560	-15.64
2:	1610	-17.64

All data measured with Keysight E5071C VNA

12. Reference board

A reference board is used for evaluating the antenna SR4G080 and it includes a SMA female connector. (Part number: SR4G080-EVB-1)

To order a reference board please see antenna.com

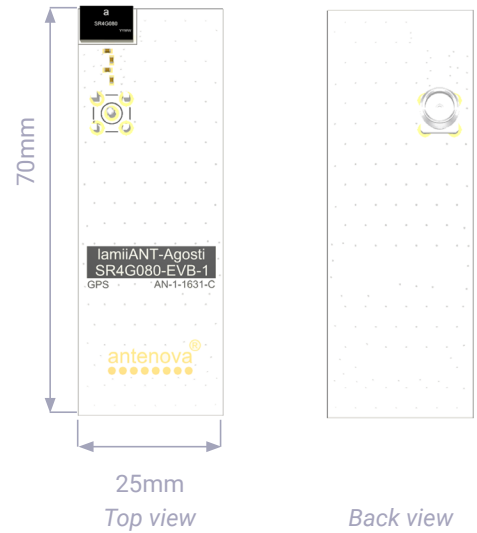

12.1. Reference board matching circuit

DESIGNATOR	TYPE	VALUE	DESCRIPTION
L1	Inductor	5.1nH	Murata LQG15HN series
C1	Capacitor	3.6pF	Murata GJM15 series
C2	Capacitor	4.3pF	Murata GJM15 series
R1	Resistor	0ohm	Non-specific

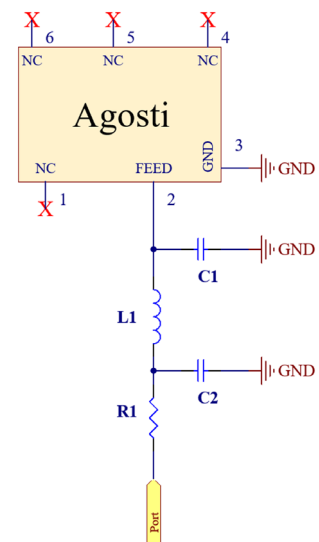

13. Soldering

This antenna is suitable for lead free soldering. The reflow profile should be adjusted to suit the device, oven and solder paste, while observing the following conditions:

- For leaded soldering, the maximum temperature should not exceed 240 °C.
- For lead free soldering, a maximum temperature of 255 °C for no more than 20 seconds is permitted.
- The antenna should not be exposed to temperatures exceeding 120 °C more than 3 times during the soldering process.

14. Hazardous material regulation conformance

The antenna has been tested to conform to RoHS and REACH requirements. A certificate of conformance is available from Antenova's website.

15. Packaging

15.1. Optimal storage conditions

TEMPERATURE	-10°C to 40°C
HUMIDITY	Less than 75% RH
SHELF LIFE	24 Months
STORAGE PLACE	Away from corrosive gas and direct sunlight
PACKAGING	Reels should be stored in unopened sealed manufacturer's plastic packaging.
MSL LEVEL	1

Note: Storage of open reels of antennas is not recommended due to possible oxidization of pads on antennas. If short term storage is necessary, then it is highly recommended that the bag containing the antenna reel is re-sealed and stored in conditions as described in the table above.

The shelf life of the antenna is 2 years provided the factory seal on the package has not been broken.

15.2. Tape characteristics

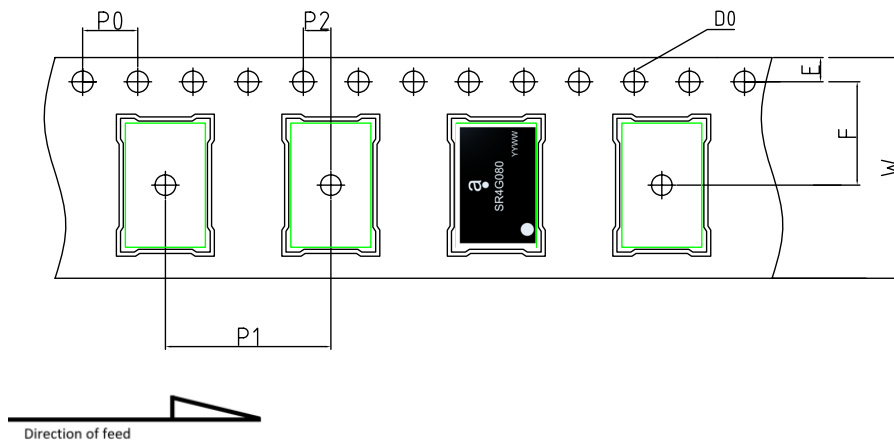

P0	P1	P2	D0
4.00 ± 0.1	12.00 ± 0.1	2.00 ± 0.1	1.50 ± 0.1

E	F	W
1.75 ± 0.1	7.50 ± 0.1	16.00 ± 0.3

All dimensions in (mm)

QUANTITY	LEADING SPACE	TRAILING SPACE
1000 pcs / reel	25 blank antenna holders	25 blank antenna holders

15.3. Reel dimensions

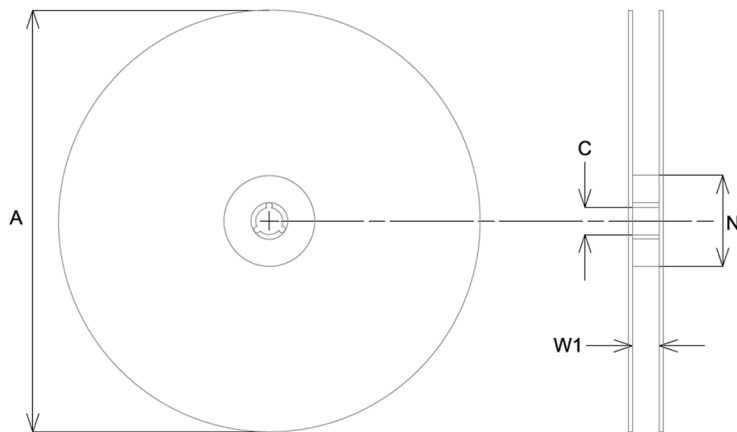

A	C	N	W1
178.0 ± 2.0	13.2 ± 0.5	60.0 ± 0.5	14.0 ± 0.3

All dimensions in (mm)

15.4. Box dimensions

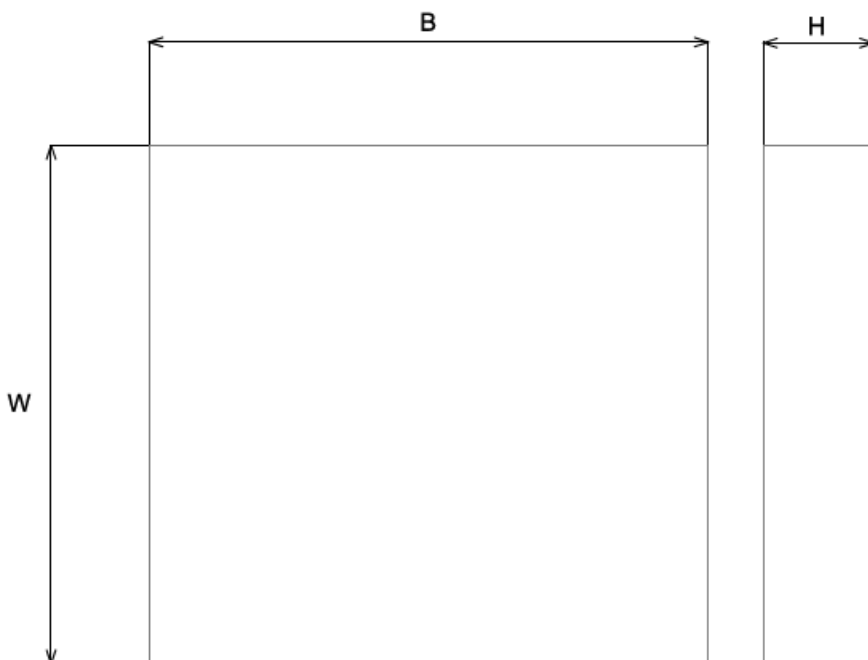

WIDTH (W)	BREADTH (B)	HEIGHT (H)
200mm	185mm	38mm

15.5. Bag properties

Reels are supplied in protective plastic packaging.

15.6. Reel label information



Quality statements

Antenova's products conform to REACH and RoHS legislation. For our statements regarding these and other quality standards, please see antenova.com.



Antenova reserves all rights to the contents of this document. Antenova gives no warranties based solely on the accuracy or completeness of the contents of this document and reserves the right to make changes to the specifications of the products described herein at any time and without notice.

Datasheet version

1.01 released Jul 31st 2022