

DATASHEET

# Lucida

SR4L002 • lamiiANT<sup>®</sup>



## Features

- Antenna for LTE applications including MIMO systems
- LTE 700, GSM850, GSM900, DCS1800, PCS1900, WCDMA2100
- LTE B7 (2500-2690 MHz), LTE B40 (2300-2400 MHz)
- High performance antenna using DFI (Designed for Integration)
- Small clearance area while maintaining high efficiency
- Innovative design with low profile
- SMD mounting
- Supplied on Tape and Reel

# Contents

<b>1.</b>	<b>Description</b>	<b>2</b>
<b>2.</b>	<b>Applications</b>	<b>2</b>
<b>3.</b>	<b>General data</b>	<b>2</b>
<b>4.</b>	<b>Part number</b>	<b>3</b>
<b>5.</b>	<b>RF characteristics</b>	<b>3</b>
<b>6.</b>	<b>RF performance</b>	<b>4</b>
<b>6.1.</b>	Return loss	4
<b>6.2.</b>	VSWR	4
<b>6.3.</b>	Efficiency	5
<b>6.4.</b>	Antenna pattern	6
<b>6.5.</b>	Optimising antenna efficiency	11
<b>7.</b>	<b>Antenna dimensions</b>	<b>12</b>
<b>8.</b>	<b>Schematic symbol and pin definition</b>	<b>13</b>
<b>9.</b>	<b>Host PCB footprint</b>	<b>13</b>
<b>10.</b>	<b>Electrical interface</b>	<b>14</b>
<b>10.1.</b>	Transmission line	14
<b>10.2.</b>	Matching circuit	14
<b>11.</b>	<b>Antenna integration guide</b>	<b>15</b>
<b>11.1.</b>	Antenna placement	15
<b>11.2.</b>	Host PCB layout	16
<b>11.3.</b>	Host PCB clearance	16
<b>11.4.</b>	Diversity	16
<b>12.</b>	<b>Reference board</b>	<b>17</b>
<b>12.1.</b>	Reference board matching circuit	17
<b>13.</b>	<b>Soldering</b>	<b>18</b>
<b>14.</b>	<b>Hazardous material regulation conformance</b>	<b>18</b>
<b>15.</b>	<b>Packaging</b>	<b>18</b>
<b>15.1.</b>	Optimal storage conditions	18
<b>15.2.</b>	Tape characteristics	19
<b>15.3.</b>	Reel dimensions	20
<b>15.4.</b>	Box dimensions	20
<b>15.5.</b>	Bag properties	21
<b>15.6.</b>	Reel label information	21

## 1. Description

---

A compact low profile antenna for all 4G/LTE applications, including MIMO systems. The novel design of the antenna reduces susceptibility to detuning.

## 2. Applications

---

- 4G MiFi routers
- Pico base stations
- Portable devices
- Telematics devices
- OBDII & Automotive devices
- Network devices
- Wearable devices

## 3. General data

---

FREQUENCY	698-824MHz 824-960MHz 1710-2170MHz 2300-2400MHz 2500-2690MHz
POLARIZATION	Linear
OPERATING TEMPERATURE	-40°C to 140°C
ENVIRONMENTAL CONDITION TEST	ISO16750-4 5.1.1.1/5.1.2.1/5.3.2
IMPEDANCE WITH MATCHING	50 Ω
WEIGHT	<2.0g
ANTENNA TYPE	SMD
DIMENSIONS	35.0 x 8.5 x 3.3 (mm)

## 4. Part number

LUCIDA  
SR4L002



## 5. RF characteristics

	698-824MHZ	824-960MHZ	1710-2170MHZ
PEAK GAIN	0.5dBi	1.0dBi	2.5dBi
AVERAGE GAIN (LINEAR)	-1.5dBi	-1.5dBi	-1.5dBi
AVERAGE EFFICIENCY	>45%	>60%	>65%
MAXIMUM RETURN LOSS	-6.0dB	-6.0dB	-6.0dB
MAXIMUM VSWR	3.2:1	2.8:1	3.1:1

	2300-2400MHZ	2500-2690MHZ
PEAK GAIN	1.6dBi	2.5dBi
AVERAGE GAIN (LINEAR)	-2.0dBi	-2.0dBi
AVERAGE EFFICIENCY	>50%	>50%
MAXIMUM RETURN LOSS	-10.0dB	-5.0dB
MAXIMUM VSWR	1.7:1	3.4:1

All data measured on Antenna's evaluation PCB Part  
No. SR4L002-EVB-1

## 6. RF performance

### 6.1. Return loss

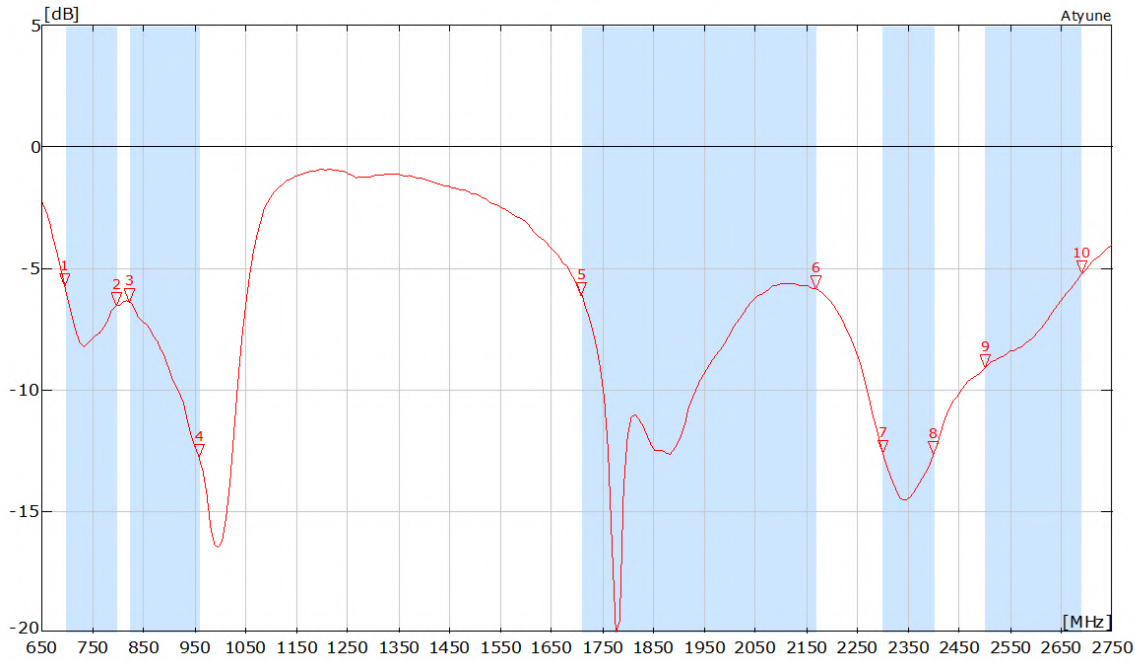

### 6.2. VSWR

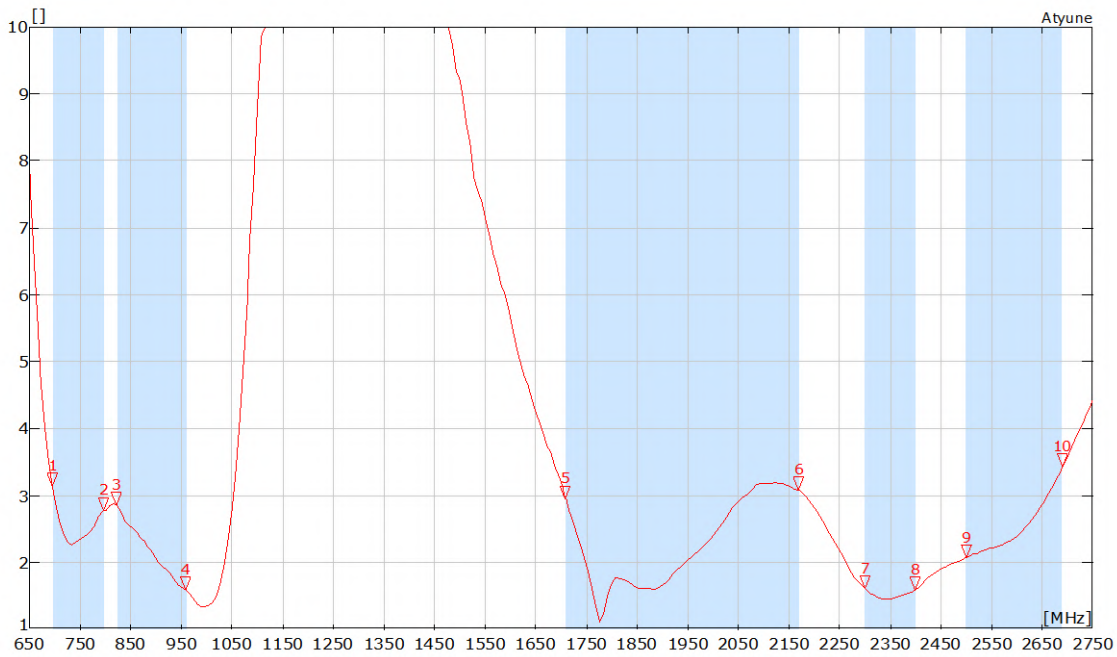

### 6.3. Efficiency

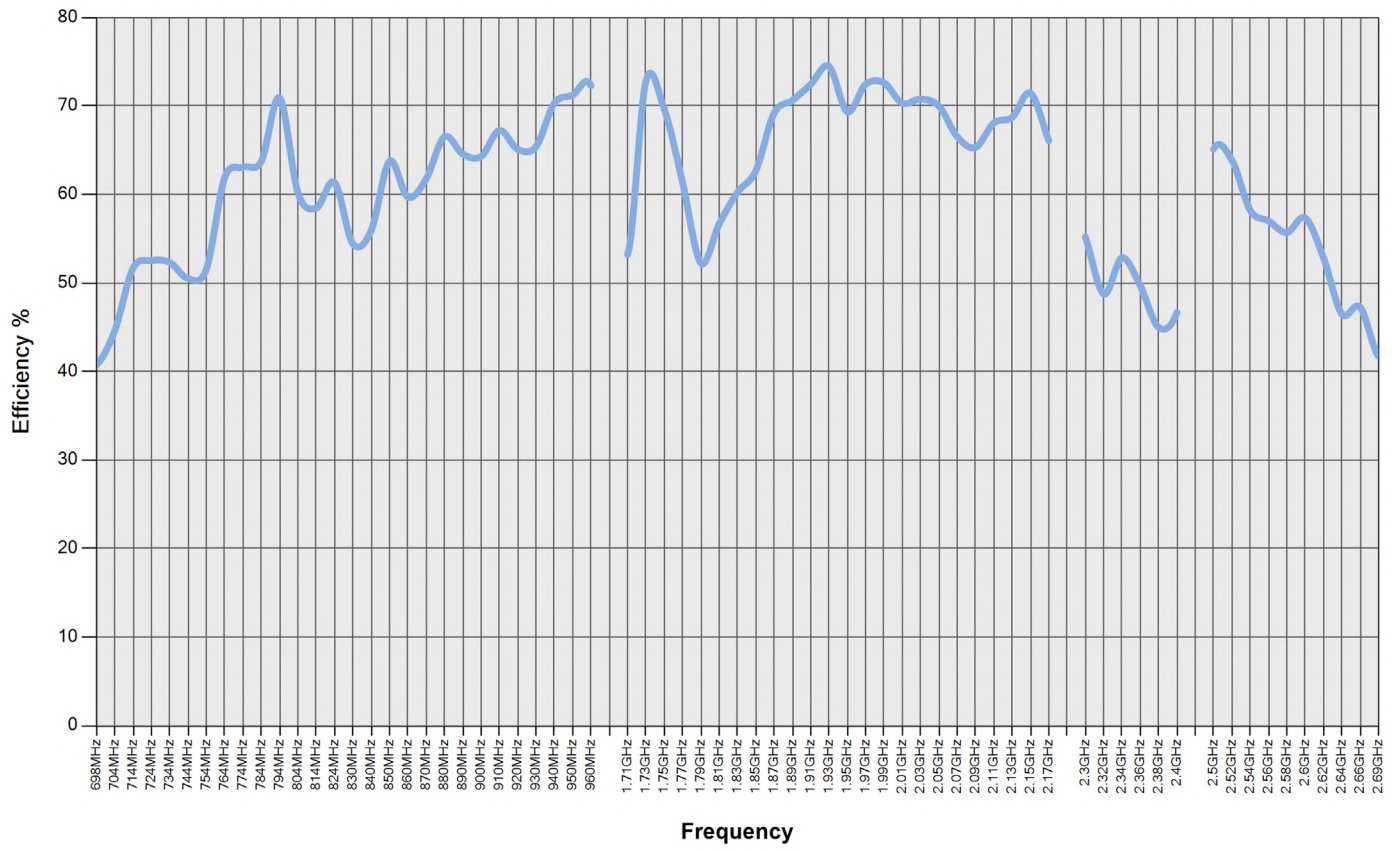

## 6.4. Antenna pattern

### 6.4.1. 698 MHz – 824 MHz

3D pattern at 734MHz

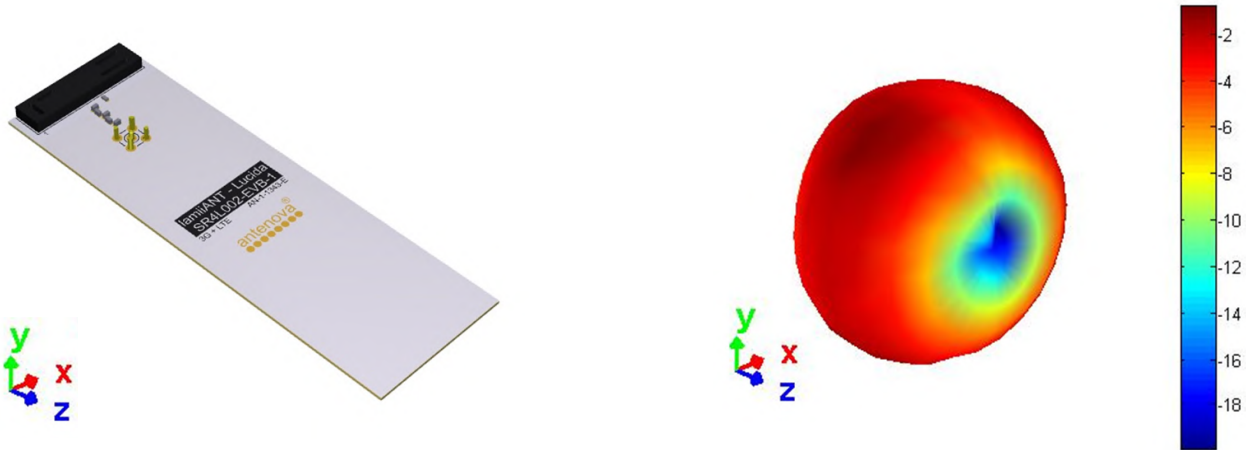

XY

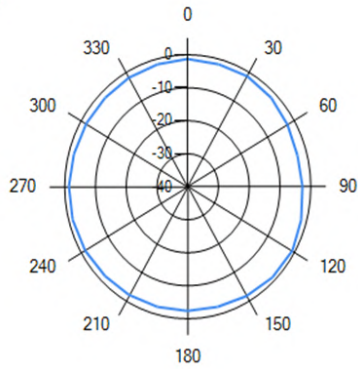

XZ

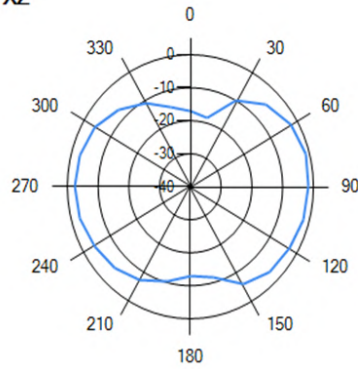

YZ

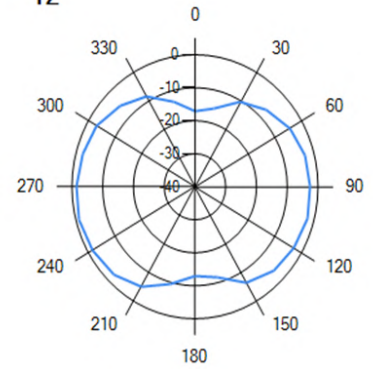

— 734MHz

6.4.2. 824 MHz – 960 MHz

3D pattern at 900MHz

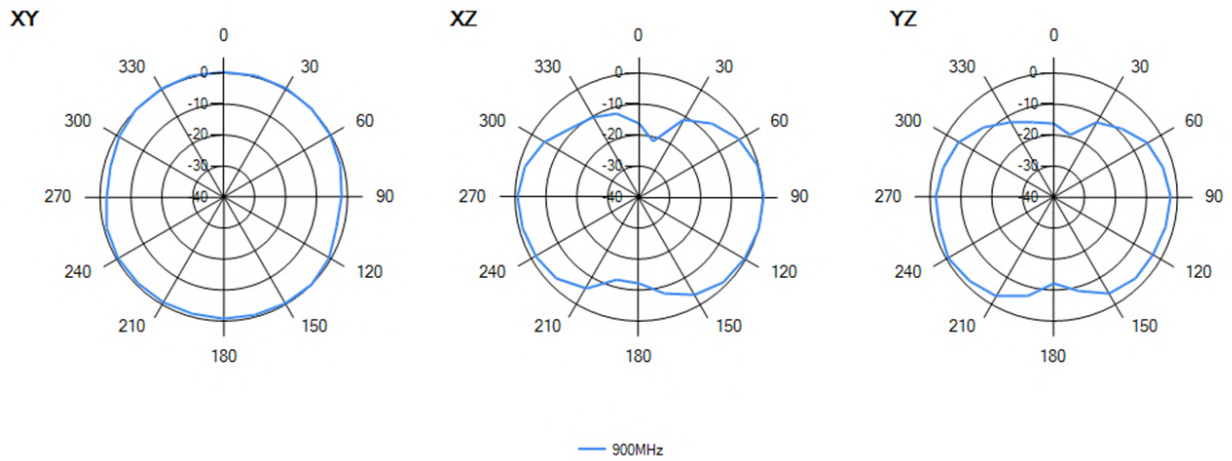
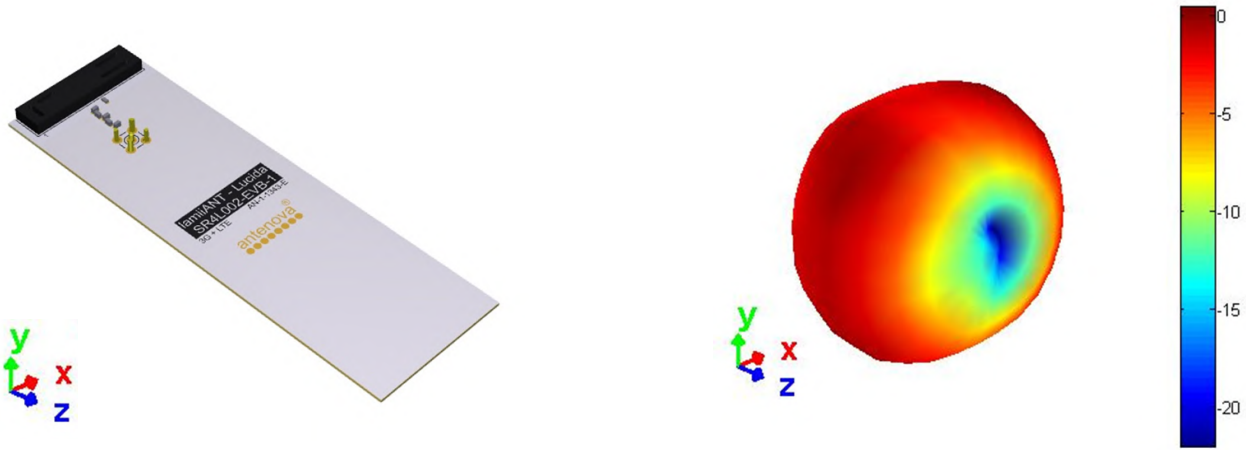



6.4.3. 1710 MHz – 2170 MHz

3D pattern at 1930MHz

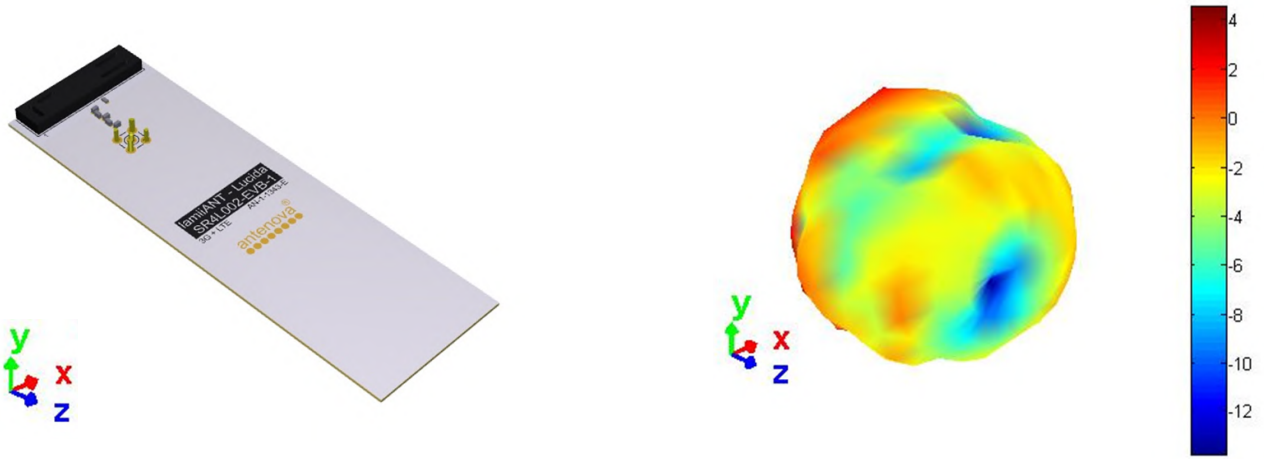

XY

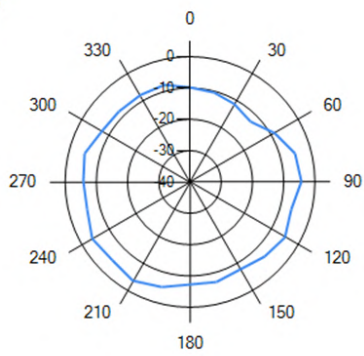

XZ

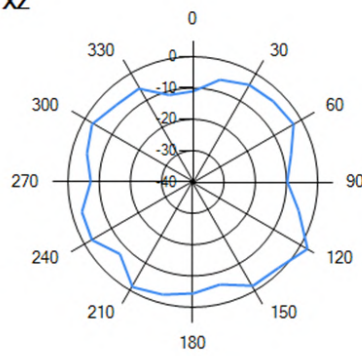

YZ

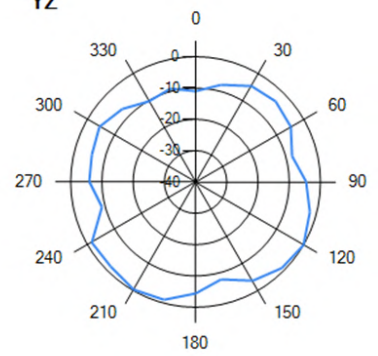

— 1.93GHz

6.4.4. 2300 MHz – 2400 MHz

3D pattern at 2340MHz

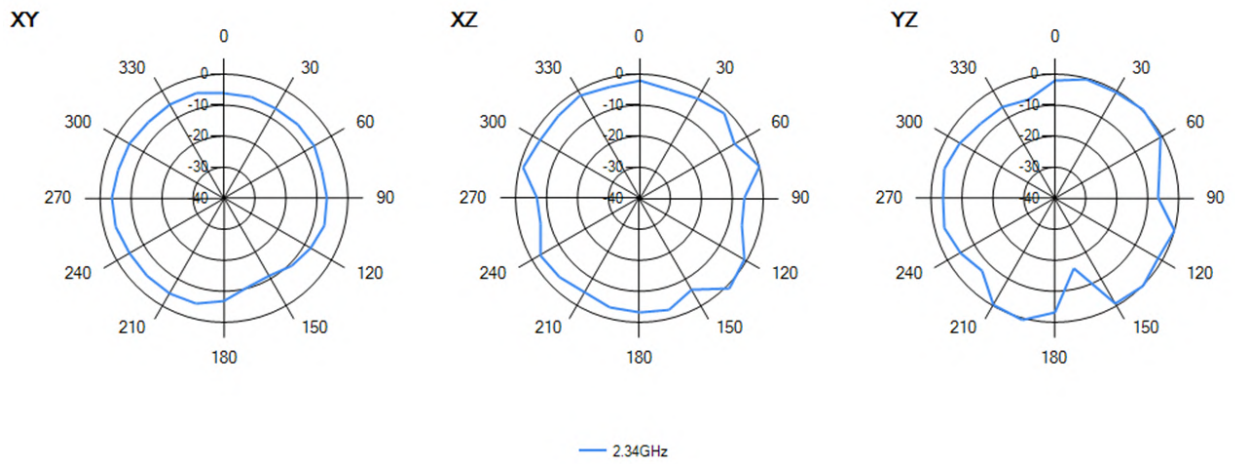
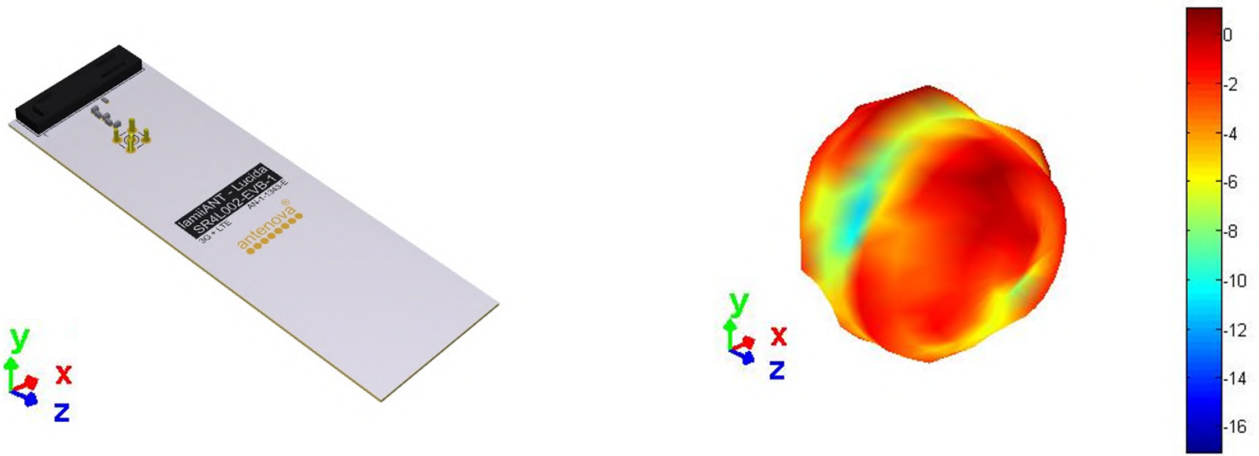

6.4.5. 2500 MHz – 2690 MHz

3D pattern at 2600MHz

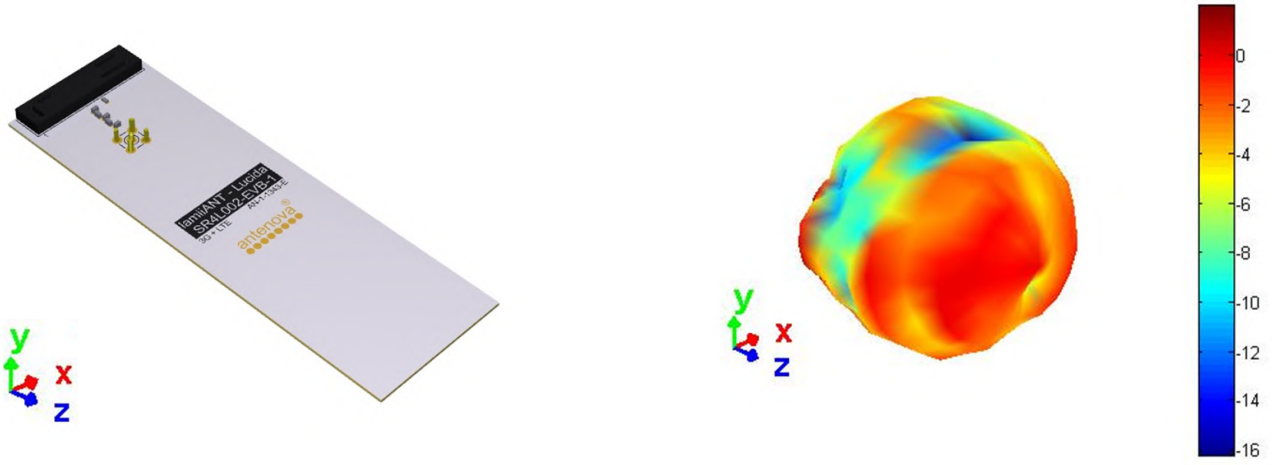

XY

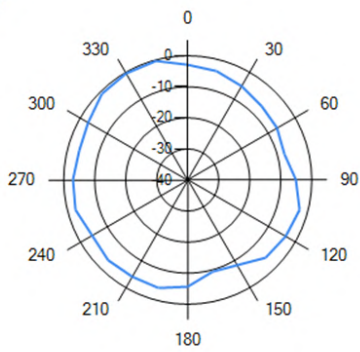

XZ

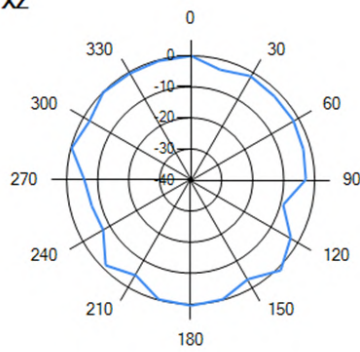

YZ

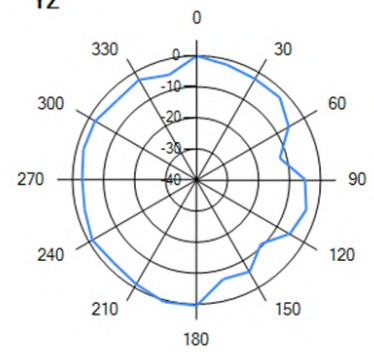

— 2.6GHz

## 6.5. Optimising antenna efficiency

---

All SMD cellular antennas require a ground plane on the host PCB for best radiation efficiency, especially in the sub-GHz bands. On an ideal PCB the antenna needs the ground plane length to be greater than a quarter wavelength of the lowest frequency used. If the ground plane is less than this, the efficiency will be reduced. E.g. to calculate the wavelength of 698MHz:

$$\lambda = \frac{c}{f} = \frac{3 \times 10^8}{698 \times 10^6} = 430 \text{mm}$$

$$\frac{1}{4} \lambda = 107 \text{mm}$$

In practise, the optimum PCB length will be slightly greater than  $\frac{1}{4}$  wavelength + antenna + clearance area, for Lucida that optimum PCB length is 125mm.

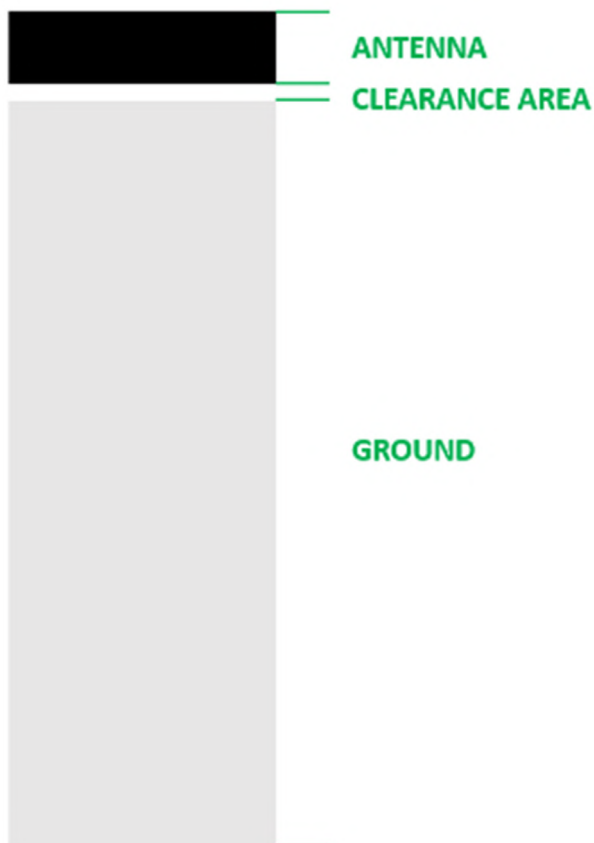

## 7. Antenna dimensions



Top view

L	W	H
Length	Width	Height
35.0 ±0.1	8.5 ±0.1	3.3 ±0.1

All dimensions in (mm)

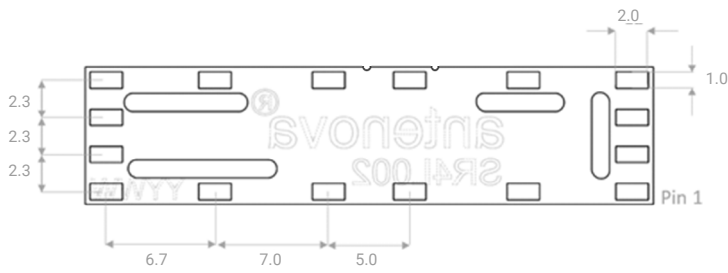

Bottom view

## 8. Schematic symbol and pin definition

The circuit symbol for the antenna is shown below. The antenna has 16 pins with only 2 as functional. All other pins are for mechanical strength.

PIN	DESCRIPTION
3	Feed (Transceiver port)
4	Return/GND
1, 2, 5, 6, 7, 8, 9, 10, 11, 12, 13, 14, 15, 16	NC (Not used, mechanical only)

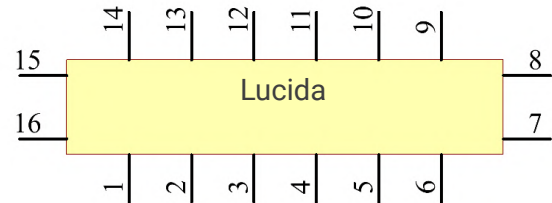

## 9. Host PCB footprint

The recommended host PCB footprint is below.

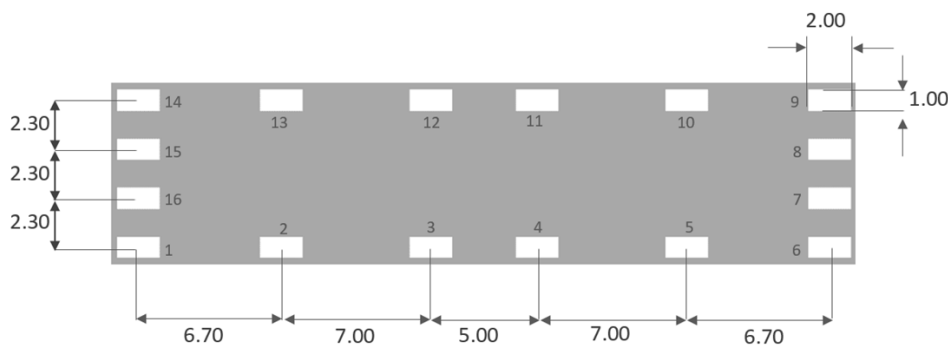

Pads 1-16 = 2.0 x 1.0 (mm)

## 10. Electrical interface

### 10.1. Transmission line

All transmission lines should be designed to have a characteristic impedance of 50Ω.

- The length of each transmission lines should be kept to a minimum
- All other parts of the RF system like transceivers, power amplifiers, etc, should also be designed to have a 50 Ω impedance

A co-planar transmission line can be designed using an online transmission line calculator tool, such as:

<https://blog.antenova.com/rf-transmission-line-calculator>

The PCB thickness, copper thickness and substrate dielectric constant are entered, then the tool calculates the transmission line width and gaps on either side of the track to give a 50 Ω impedance.

### 10.2. Matching circuit

The antenna requires a matching circuit that must be optimized for each product. The matching circuit will require up to six components and the following circuit should be designed into the host PCB. Not all components may be required but should be included as a precaution. The matching network should be placed close to the antenna feed to ensure it is optionally effective in tuning the antenna.

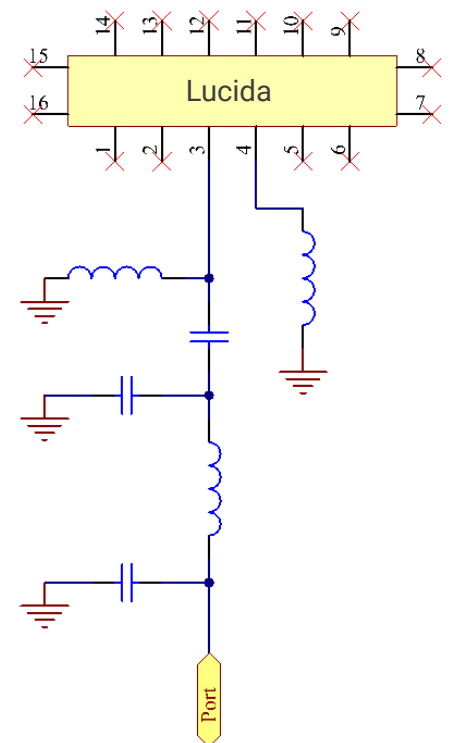

## 11. Antenna integration guide

We recommend the following during the design phase to maximise antenna performance and minimize noise:

- Minimum 4 layer PCB
- Route signals and power internally where possible
- Flood all layers with ground
- Knit ground on all layers together with plenty of vias

Follow placement guidance carefully, in addition Antenova provide technical support to help you through all stages of your design. Register for an account on <https://ask.antenova.com/> to access technical support.

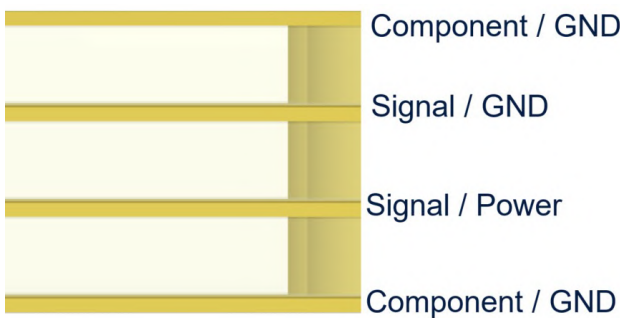

### 11.1. Antenna placement

The best position for the antenna is in the corner of the short side of the PCB. This allows the longer side of the PCB to be a ground plane, a long ground plane improves the antenna's efficiency. The antenna requires clearance ideally in 5 spatial directions as shown below. Where this cannot be achieved you should keep as many clear as possible to a minimum of 3. Please note performance will degrade with fewer clearances.

The Antenova placement tool can be used to advise on antenna placement, see: <https://blog.antenova.com/intelligent-antenna-selection-and-placement-tool-antenova>

Correct

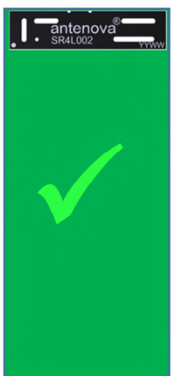

Incorrect

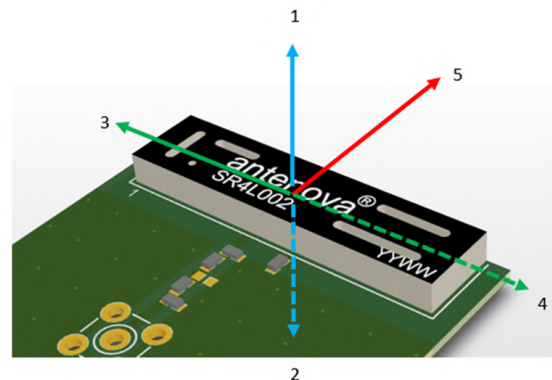
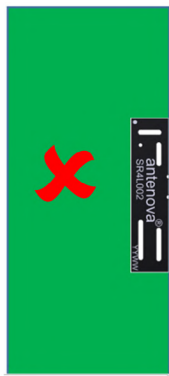



### 11.2. Host PCB layout

The host PCB must be designed using the PCB footprint shown with the correct clearances. An example of the PCB layout shows the antenna footprint. Please note this clearance area is critical to the performance of the antenna and must be applied through all layers of the PCB.

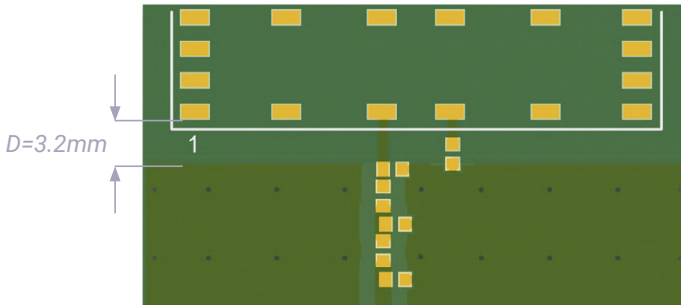

All dimensions in (mm)

### 11.3. Host PCB clearance

The diagram below shows the antenna footprint and clearance through all layers on the PCB. Only the antenna pads and connections to feed and GND are present within this clearance area.

Placement of components and GND with traces adjacent to the antenna should maintain a minimum clearance of 15mm from either side. The antenna should therefore be placed in the corner to only have one side affected.

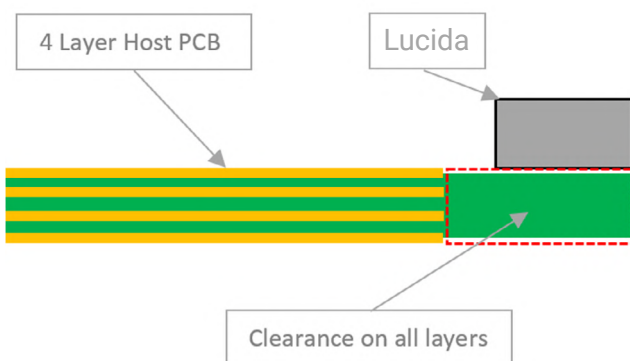

### 11.4. Diversity

The Lucida antenna is suitable for use in diversity antennas. To implement a diversity antenna, follow the guidance given in the Diversity Antennas app note. This can be downloaded from [Antenova.com](https://www.antenova.com).

## 12. Reference board

A reference board is used for evaluating the antenna SR4L002 and it includes a SMA female connector. (Part number: SR4L002-EVB-1)

To order a reference board please see [antenna.com](http://antenna.com)



### 12.1. Reference board matching circuit

DESIGNATOR	TYPE	VALUE	DESCRIPTION
L1, L3	Inductor	15nH	Murata LQG15HN series
L2	Inductor	3.3nH	Murata LQG15HN series
C1	Capacitor	2.2pF	Murata GJM15 series
C2	NA	DNP	Not Fitted
C3	Capacitor	0.5pF	Murata GJM15 series

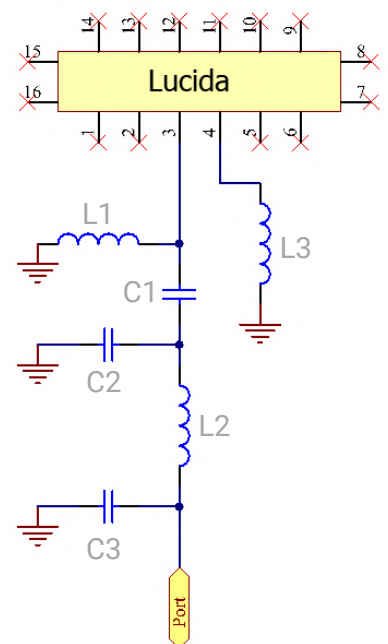

## 13. Soldering

---

This antenna is suitable for lead free soldering. The reflow profile should be adjusted to suit the device, oven and solder paste, while observing the following conditions:

- For leaded soldering, the maximum temperature should not exceed 240 °C.
- For lead free soldering, a maximum temperature of 255 °C for no more than 20 seconds is permitted.
- The antenna should not be exposed to temperatures exceeding 120 °C more than 3 times during the soldering process.

## 14. Hazardous material regulation conformance

---

The antenna has been tested to conform to RoHS and REACH requirements. A certificate of conformance is available from Antenova's website.

## 15. Packaging

---

### 15.1. Optimal storage conditions

---

TEMPERATURE	-10°C to 40°C
HUMIDITY	Less than 75% RH
SHELF LIFE	24 Months
STORAGE PLACE	Away from corrosive gas and direct sunlight
PACKAGING	Reels should be stored in unopened sealed manufacturer's plastic packaging.
MSL LEVEL	1

Note: Storage of open reels of antennas is not recommended due to possible oxidization of pads on antennas. If short term storage is necessary, then it is highly recommended that the bag containing the antenna reel is re-sealed and stored in conditions as described in the table above.

The shelf life of the antenna is 2 years provided the factory seal on the package has not been broken.

15.2. Tape characteristics

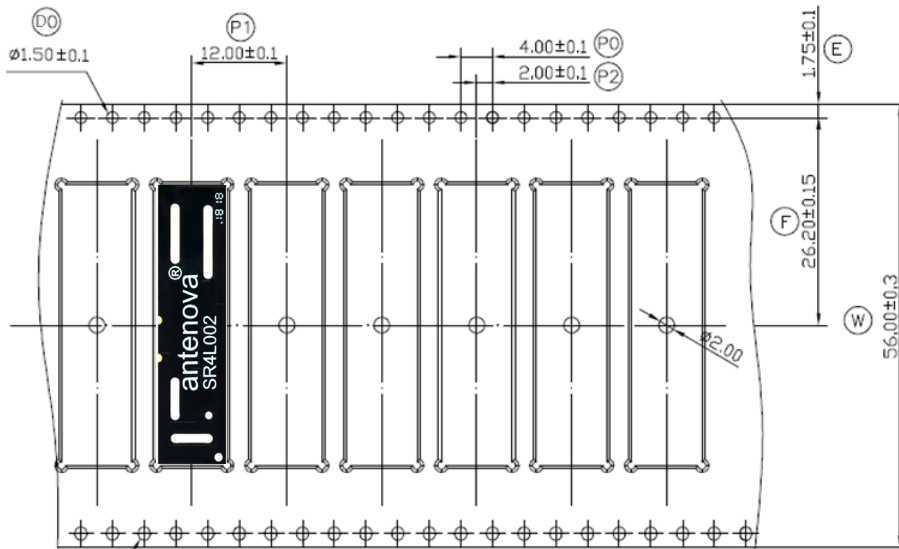

P0	P1	P2	D0
4.00 ± 0.1	12.00 ± 0.1	2.00 ± 0.1	1.50 ± 0.1

E	F	W
1.75 ± 0.1	26.20 ± 0.15	56.00 ± 0.3

All dimensions in (mm)

QUANTITY	LEADING SPACE	TRAILING SPACE
1000 pcs / reel	30 blank antenna holders	30 blank antenna holders

### 15.3. Reel dimensions

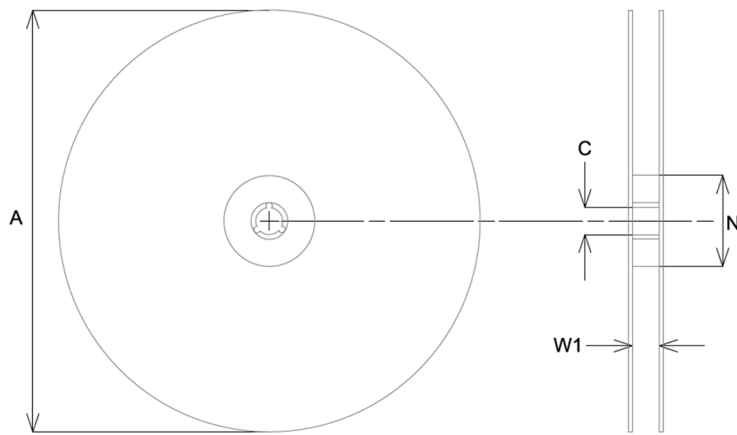

A	C	N	W1
330.0 ± 2.0	13.0 ± 0.5	100.0 ± 0.5	56 ± 0.3

All dimensions in (mm)

### 15.4. Box dimensions

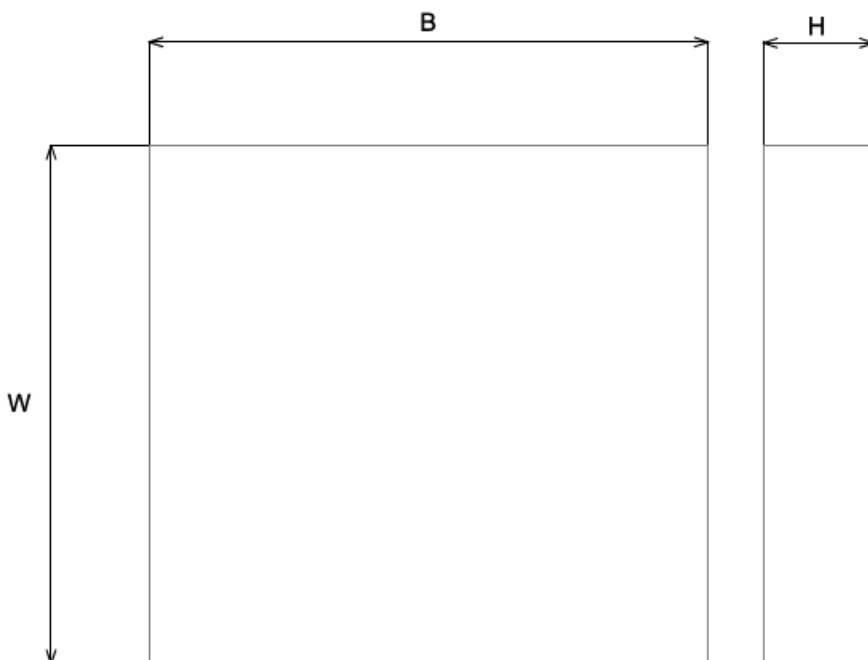

WIDTH (W)	BREADTH (B)	HEIGHT (H)
350mm	355mm	70mm

### 15.5. Bag properties

---

Reels are supplied in protective plastic packaging.

### 15.6. Reel label information

---



### Quality statements

Antenova’s products conform to REACH and RoHS legislation. For our statements regarding these and other quality standards, please see [antenova.com](http://antenova.com).



Antenova reserves all rights to the contents of this document. Antenova gives no warranties based solely on the accuracy or completeness of the contents of this document and reserves the right to make changes to the specifications of the products described herein at any time and without notice.

### Datasheet version

3.01 released Aug 24th 2021

3.02 released Apr 21th 2022