

DATASHEET

Inversa

SR4L034-L • lamiiANT®
SR4L034-R • lamiiANT®

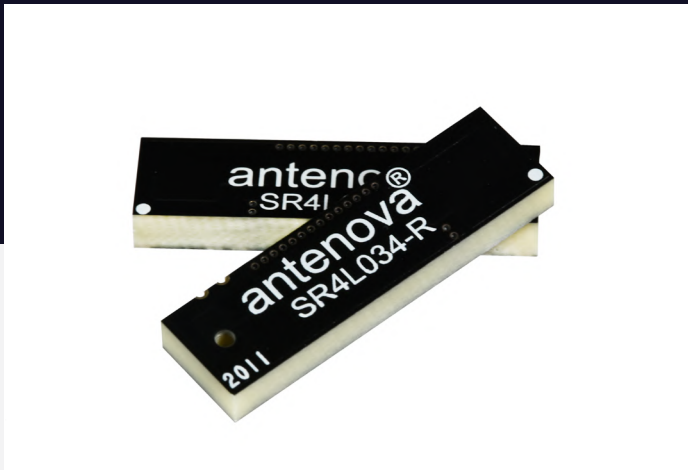

Features

- Antenna for 3G and 4G applications
- LTE, GSM, CDMA, DCS, PCS, WCDMA, UMTS, HSPDA, GPRS, EDGE, IMT
- Frequencies: 698-960MHz; 1710-2170MHz; 2300-2400MHz; 2500-2690MHz
- Corner placement for ergonomic design-in
- SMD mounted device
- Supplied on Tape and Reel
- Automotive temperature rating
- Compact 28 x 8 x 3.3mm
- Ideal for MIMO systems

Contents

1.	Description	2
2.	Applications	2
3.	General data	2
4.	Part number	3
5.	RF characteristics	3
6.	RF performance	4
6.1.	Return loss	4
6.2.	VSWR	4
6.3.	Efficiency	5
6.4.	Antenna pattern	6
6.5.	Optimising antenna efficiency	11
7.	Antenna dimensions	12
8.	Schematic symbol and pin definition	13
9.	Host PCB footprint	13
10.	Electrical interface	14
10.1.	Transmission line	14
10.2.	Matching circuit	14
11.	Antenna integration guide	15
11.1.	Antenna placement	15
11.2.	Host PCB layout	16
11.3.	Host PCB clearance	16
11.4.	Diversity	16
12.	Reference board	17
12.1.	Reference board matching circuit	17
13.	Soldering	18
14.	Hazardous material regulation conformance	18
15.	Packaging	18
15.1.	Optimal storage conditions	18
15.2.	Tape characteristics	19
15.3.	Reel dimensions	20
15.4.	Box dimensions	20
15.5.	Bag properties	21
15.6.	Reel label information	21

1. Description

Inversa is intended for use with 3G/4G applications. As a single antenna or in MIMO systems, this antenna was specifically designed for coexistence and minimal space requirements by being corner placed on the host PCB. This product specification shows the performance of the antenna over all stated frequency ranges.

2. Applications

- 4G Mi-Fi Routers
- Medical equipment
- Tablets
- OBD2 systems
- MIMO Systems
- Femtocell / Picocell basestations
- Remote monitoring

3. General data

FREQUENCY	698-960MHz 1710-2170MHz 2300-2400MHz 2500-2690MHz
POLARIZATION	Linear
OPERATING TEMPERATURE	-40°C to 140°C
ENVIRONMENTAL CONDITION TEST	ISO16750-4 5.1.1.1/5.1.2.1/5.3.2
IMPEDANCE WITH MATCHING	50 Ω
WEIGHT	<2.5g
ANTENNA TYPE	SMD
DIMENSIONS	28.0 x 8.0 x 3.3 (mm)

4. Part number

INVERSA LEFT
SR4L034-L



INVERSA RIGHT
SR4L034-R



5. RF characteristics

	698-824MHZ	824-960MHZ	1710-2170MHZ
PEAK GAIN	0.40dBi	1.60dBi	3.50dBi
AVERAGE GAIN (LINEAR)	-2.0dBi	-1.10dBi	-2.00dBi
AVERAGE EFFICIENCY	>55%	>70%	>60%
MAXIMUM RETURN LOSS	-6.0dB	-6.6dB	-5.1dB
MAXIMUM VSWR	2.8:1	2.8:1	3.5:1

	2300-2400MHZ	2500-2690MHZ
PEAK GAIN	3.60dBi	2.10dBi
AVERAGE GAIN (LINEAR)	-1.60dBi	-2.30dBi
AVERAGE EFFICIENCY	>60%	>55%
MAXIMUM RETURN LOSS	-7.0dB	-4.9dB
MAXIMUM VSWR	2.5:1	3.7:1

All data measured on Antenna's evaluation PCB Part
No. SR4L034-EVB-4

6. RF performance

6.1. Return loss

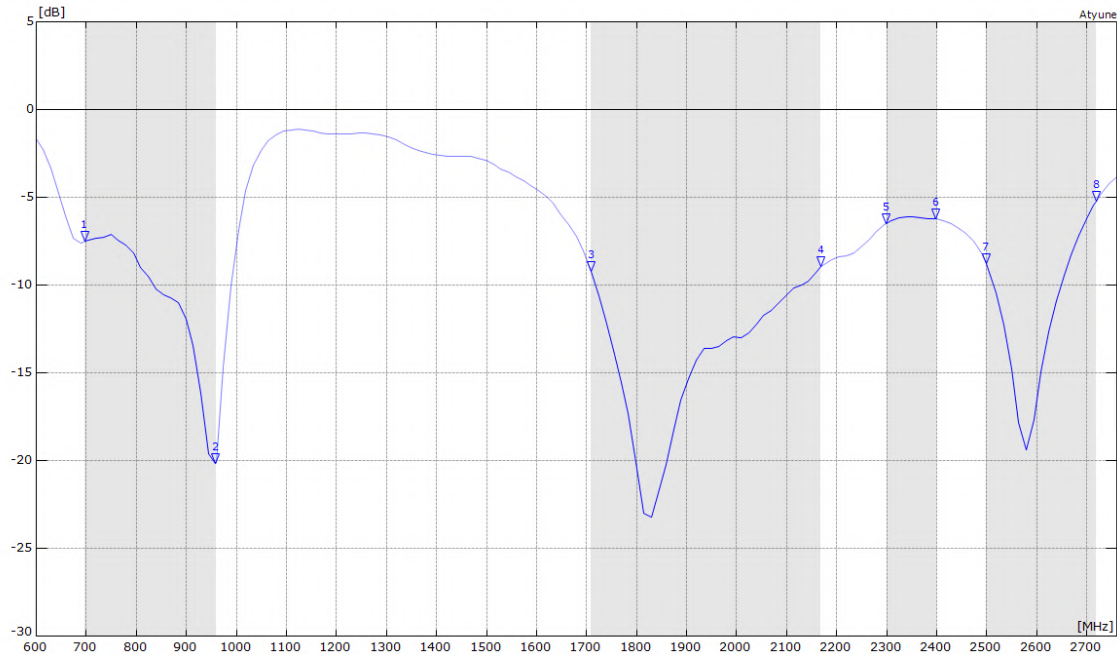

6.2. VSWR

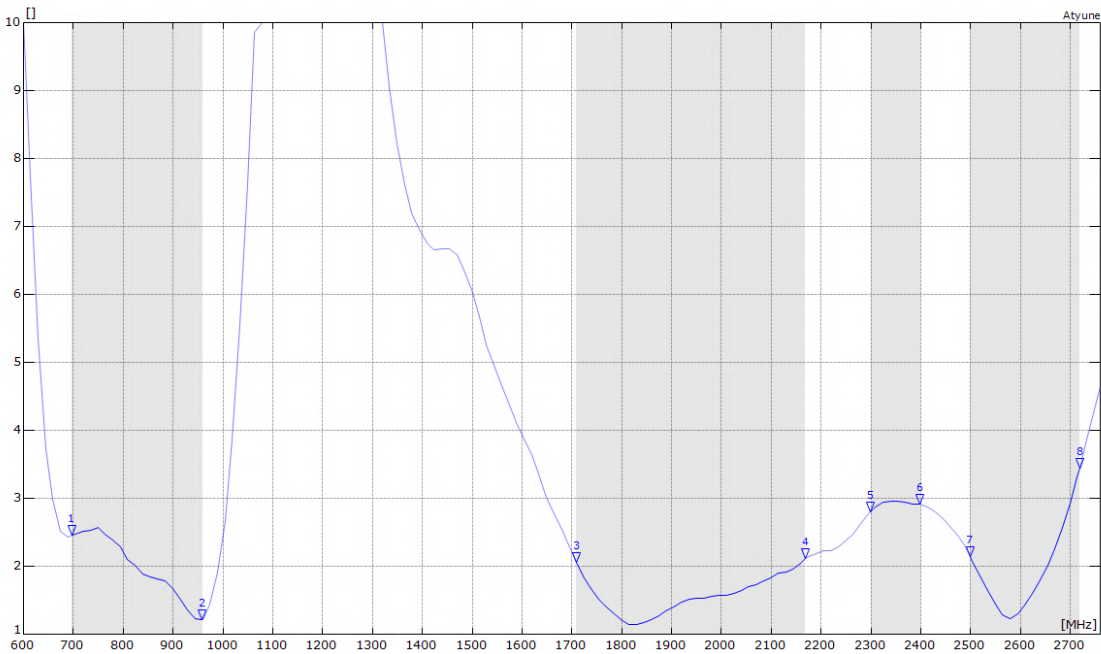

6.3. Efficiency

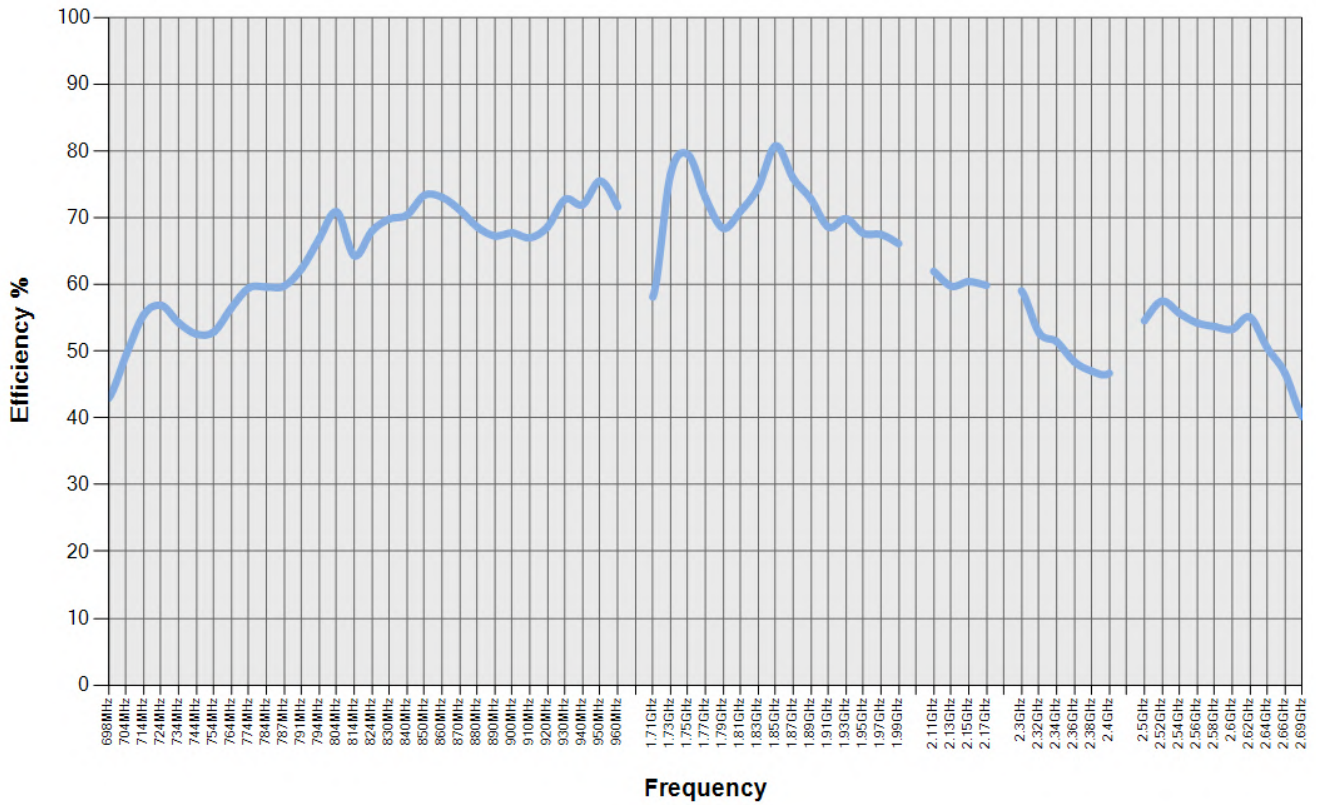

6.4. Antenna pattern

6.4.1. 698 MHz – 824 MHz

3D pattern at 746MHz

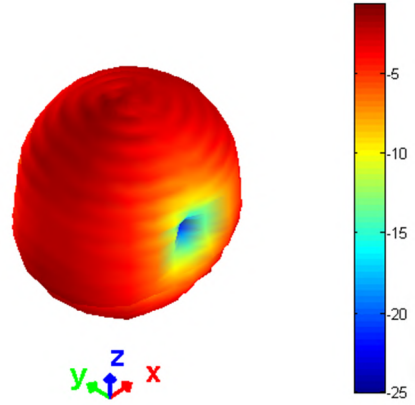

XY

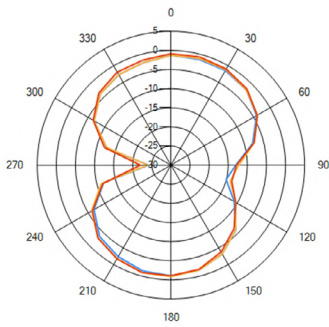

XZ

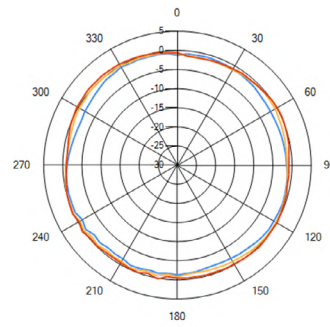

YZ

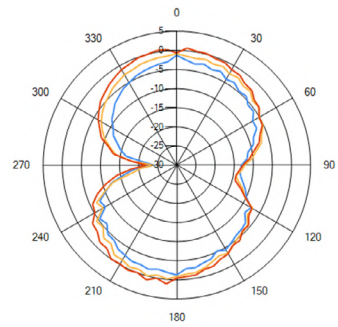

— 698MHz — 754MHz — 830MHz

6.4.2. 824 MHz – 960 MHz

3D pattern at 880MHz

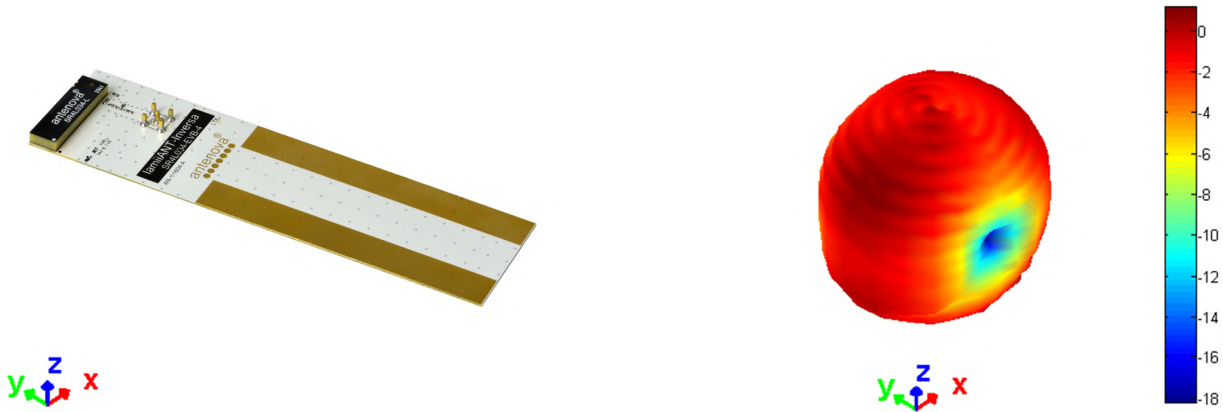

XY

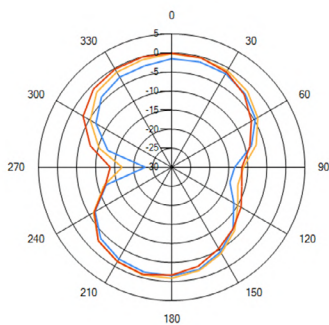

XZ

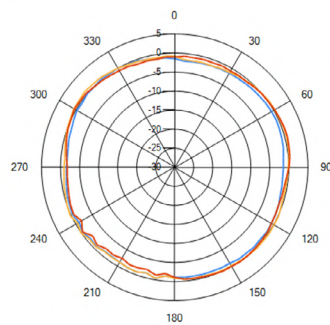

YZ

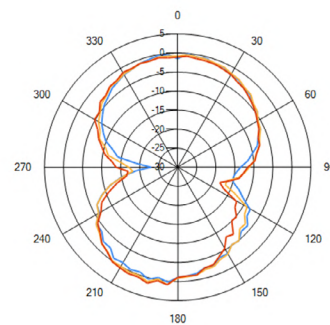

— 824MHz — 880MHz — 960MHz

6.4.3. 1710 MHz – 2170 MHz

3D pattern at 1990MHz

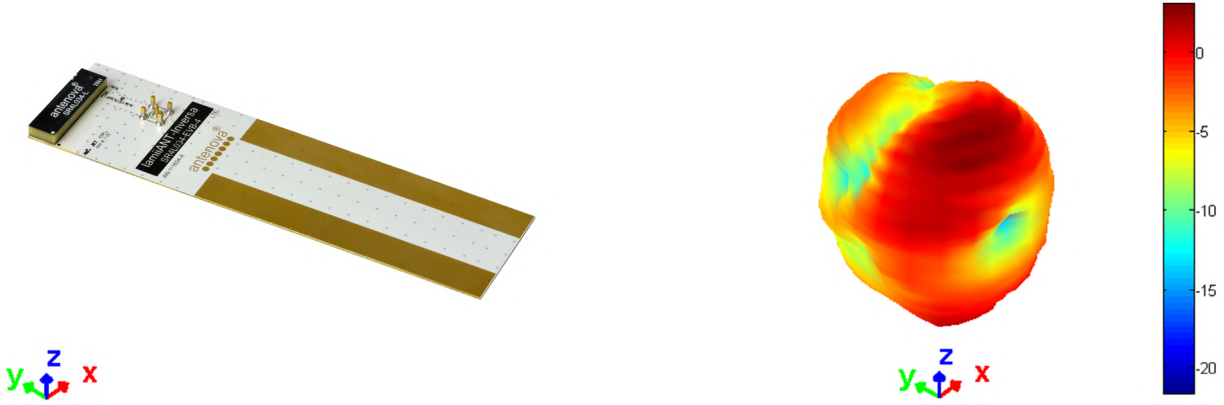

XY

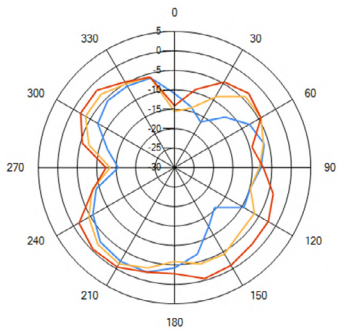

XZ

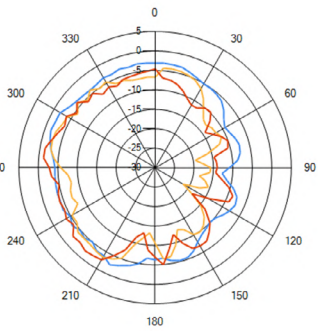

YZ

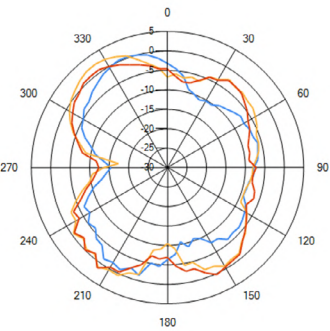

— 1.71GHz — 1.99GHz — 2.17GHz

6.4.4. 2300 MHz – 2400 MHz

3D pattern at 2.35GHz

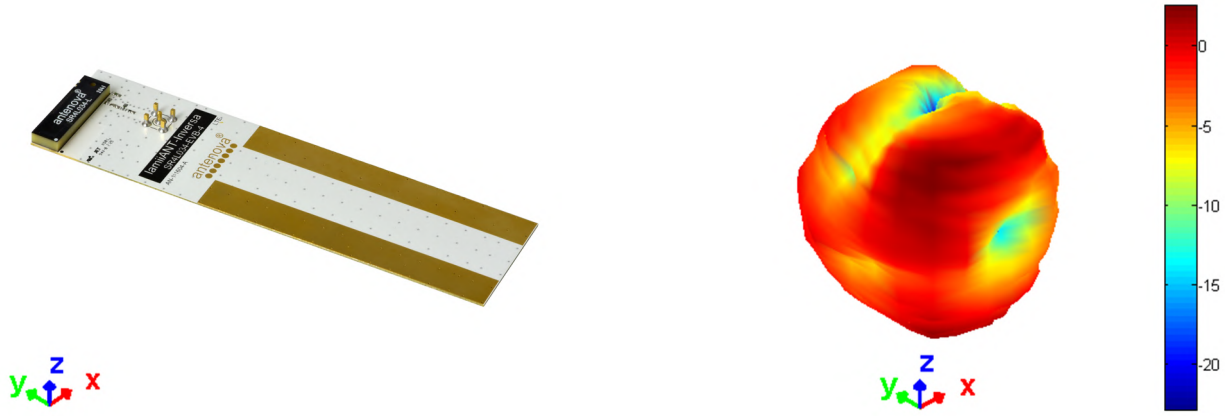

XY

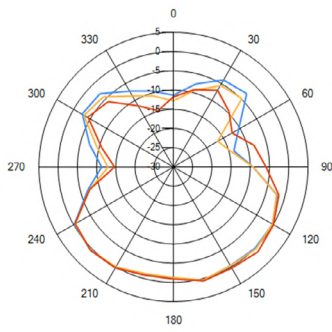

XZ

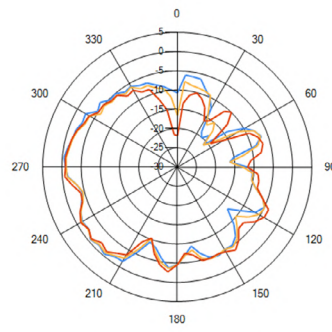

YZ

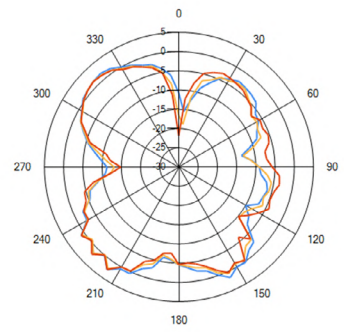

— 2.3GHz — 2.36GHz — 2.4GHz

6.4.5. 2500 MHz – 2690 MHz

3D pattern at 2.6GHz

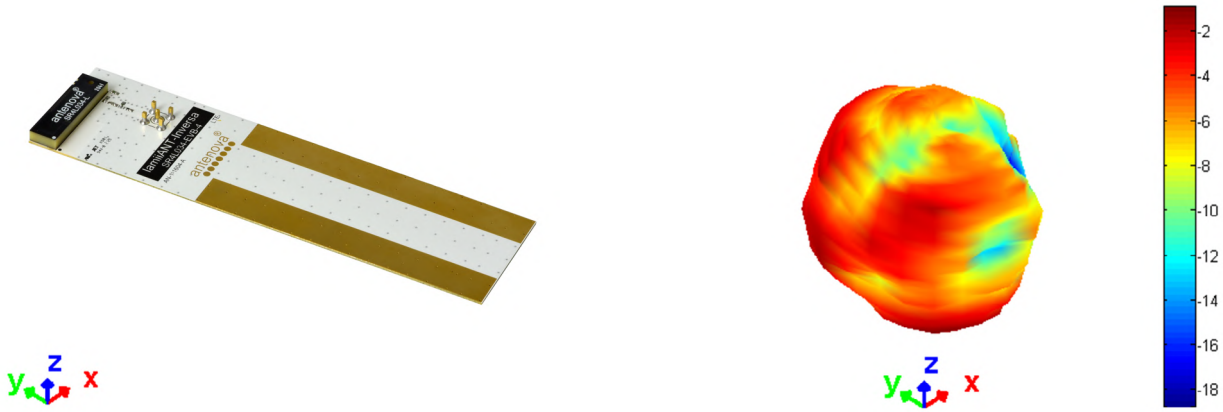

XY

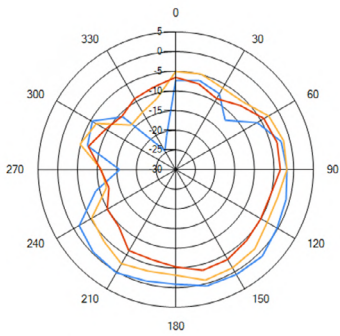

XZ

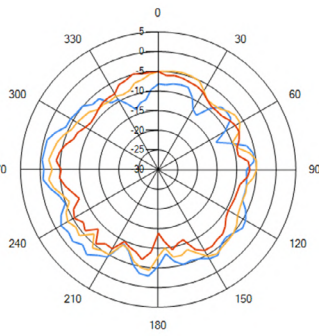

YZ

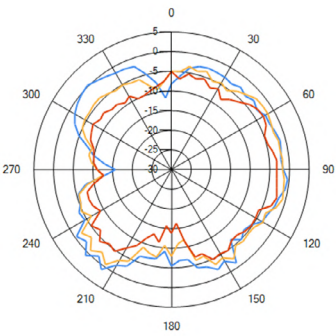

— 2.5GHz — 2.6GHz — 2.69GHz

6.5. Optimising antenna efficiency

All SMD cellular antennas require a ground plane on the host PCB for best radiation efficiency, especially in the sub-GHz bands. On an ideal PCB the antenna needs the ground plane length to be greater than a quarter wavelength of the lowest frequency used. If the ground plane is less than this, the efficiency will be reduced. E.g. to calculate the wavelength of 698MHz:

$$\lambda = \frac{c}{f} = \frac{3 \times 10^8}{698 \times 10^6} = 430 \text{mm}$$

$$\frac{1}{4} \lambda = 107 \text{mm}$$

In practise, the optimum PCB length will be slightly greater than $\frac{1}{4}$ wavelength + antenna + clearance area, for Inversa that optimum PCB length is 130mm.

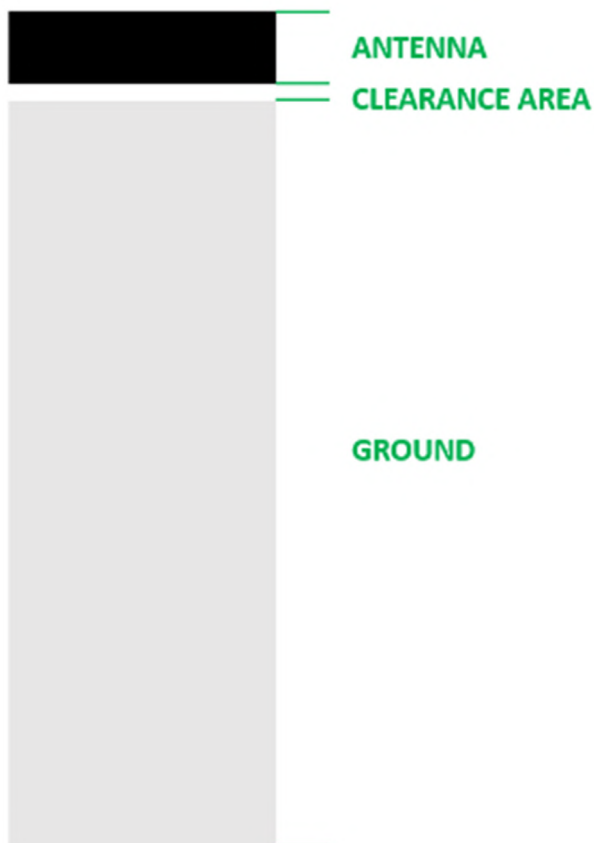

7. Antenna dimensions

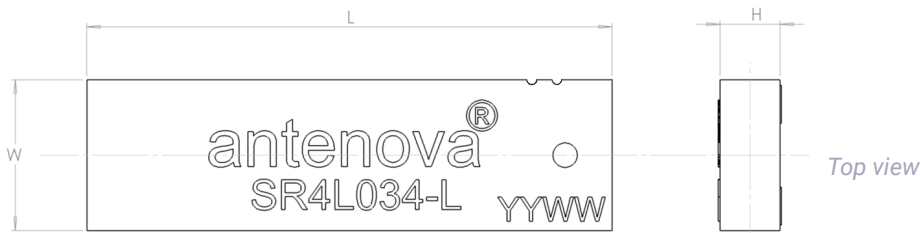

L	W	H
Length	Width	Height
28.0 ±0.1	8.0 ±0.1	3.3 ±0.1

All dimensions in (mm)
 -L and -R Dimensions are the same

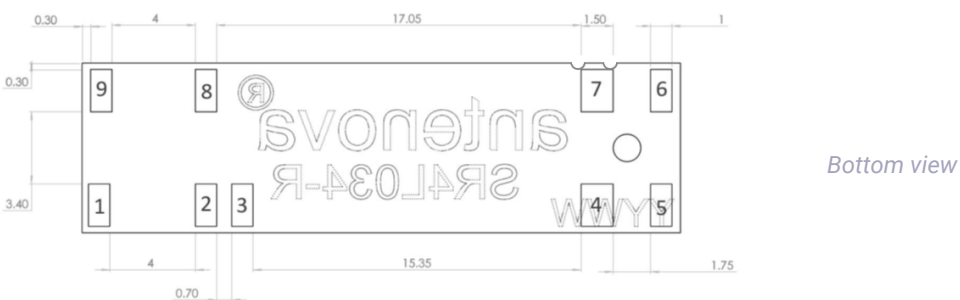
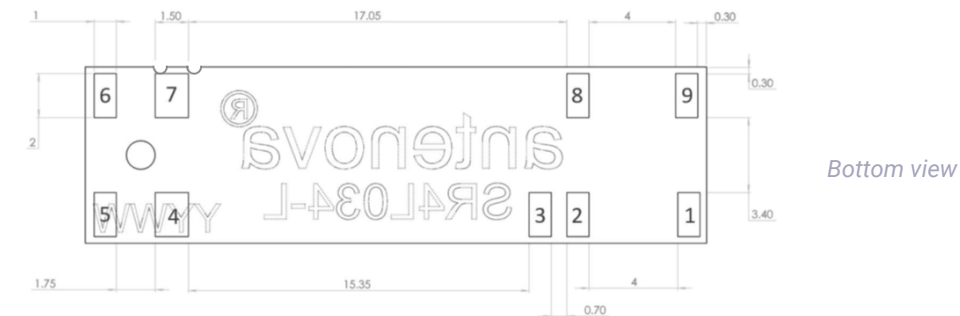

8. Schematic symbol and pin definition

The circuit symbol for the antenna is shown below. The antenna has 9 pins with only 4 as functional. All other pins are for mechanical strength.

PIN	DESCRIPTION
4	Feed (Transceiver port)
5	T1 (Return/Tuning)
1, 6, 7, 8, 9	NC (Not used, mechanical only)
2, 3	SC (Pins 2 and 3 short circuit on host PCB)

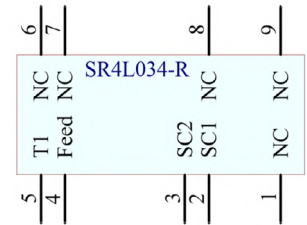
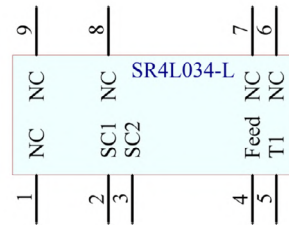

9. Host PCB footprint

The recommended host PCB footprint is below.

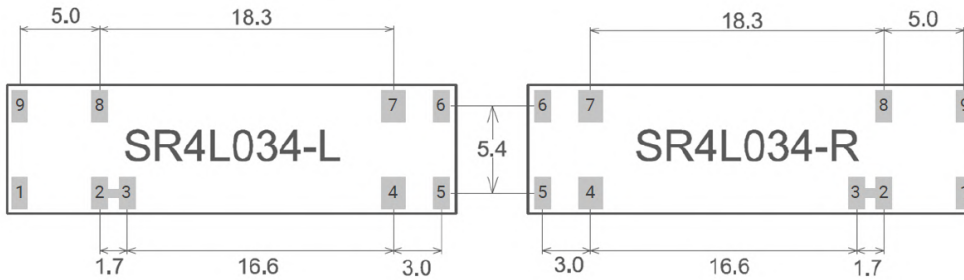

Pads 1, 2, 3, 5, 6, 8, 9 = 2.0 x 1.0 (mm)

Pads 4, 7 = 2.0 x 1.5 (mm)

10. Electrical interface

10.1. Transmission line

All transmission lines should be designed to have a characteristic impedance of 50Ω.

- The length of each transmission lines should be kept to a minimum
- All other parts of the RF system like transceivers, power amplifiers, etc, should also be designed to have a 50 Ω impedance

A co-planar transmission line can be designed using an online transmission line calculator tool, such as:

<https://blog.antenova.com/rf-transmission-line-calculator>

The PCB thickness, copper thickness and substrate dielectric constant are entered, then the tool calculates the transmission line width and gaps on either side of the track to give a 50 Ω impedance.

10.2. Matching circuit

The antenna requires a matching circuit that must be optimized for each product. The matching circuit will require up to six components and the following circuit should be designed into the host PCB. Not all components may be required but should be included as a precaution. The matching network should be placed close to the antenna feed to ensure it is optionally effective in tuning the antenna.

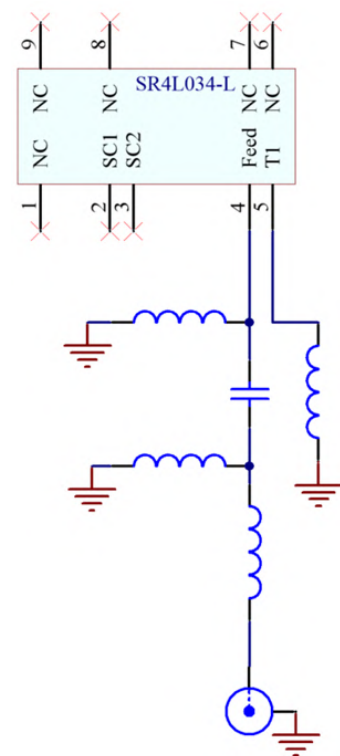

11. Antenna integration guide

We recommend the following during the design phase to maximise antenna performance and minimize noise:

- Minimum 4 layer PCB
- Route signals and power internally where possible
- Flood all layers with ground
- Knit ground on all layers together with plenty of vias

Follow placement guidance carefully, in addition Antenova provide technical support to help you through all stages of your design. Register for an account on <https://ask.antenova.com/> to access technical support.

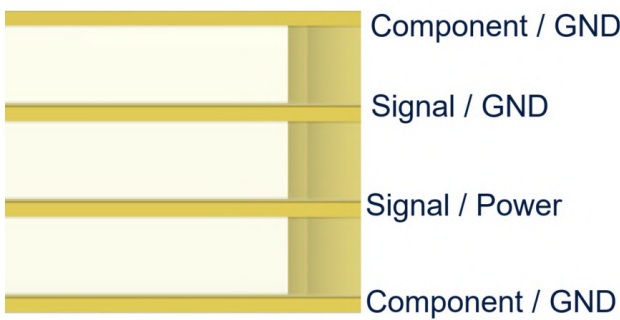

11.1. Antenna placement

The best position for the antenna is in the corner of the short side of the PCB. This allows the longer side of the PCB to be a ground plane, a long ground plane improves the antenna's efficiency. The Antenova placement tool can be used to advise on antenna placement, see:

<https://blog.antenova.com/intelligent-antenna-selection-and-placement-tool-antenova>

Horizontal placement

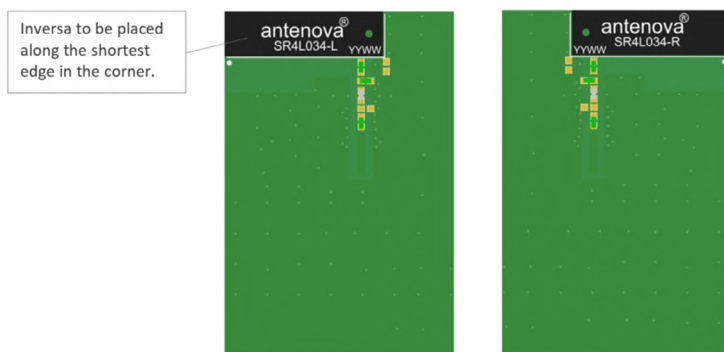

Vertical placement

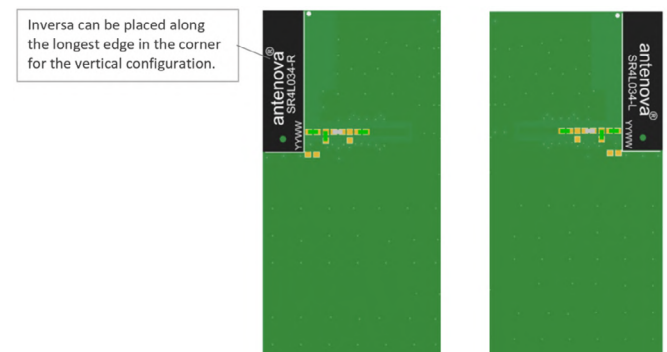

11.2. Host PCB layout

The host PCB must be designed using the PCB footprint shown with the correct clearances. An example of the PCB layout shows the antenna footprint. Please note this clearance area is critical to the performance of the antenna and must be applied through all layers of the PCB.

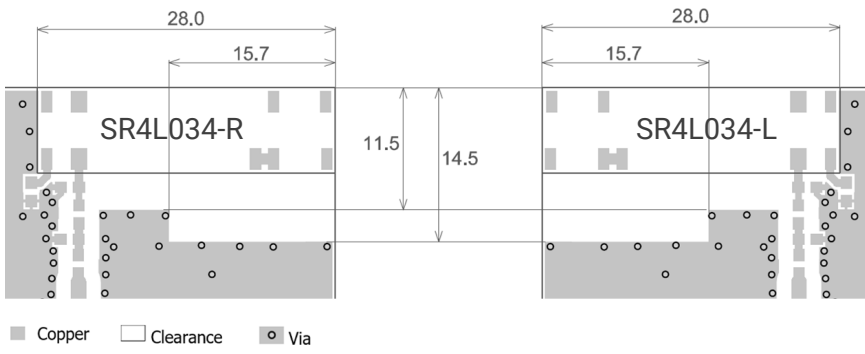

11.3. Host PCB clearance

The diagram below shows the antenna footprint and clearance through all layers on the PCB. Only the antenna pads and connections to feed and GND are present within this clearance area.

Placement of components and GND with traces adjacent to the antenna should maintain a minimum clearance of 15mm from either side. The antenna should therefore be placed in the corner to only have one side affected.

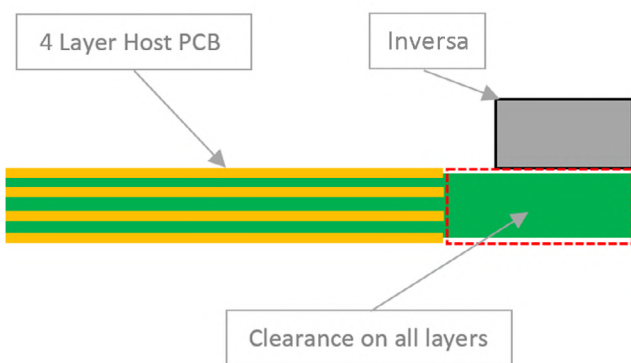

11.4. Diversity

The Inversa antenna is suitable for use in diversity antennas. To implement a diversity antenna, follow the guidance given in the Diversity Antennas app note. This can be downloaded from Antenova.com.

12. Reference board

A reference board is used for evaluating the antenna SR4L034-L and it includes a SMA female connector. (Part number: SR4L034-EVB-4)

To order a reference board please see antenna.com



12.1. Reference board matching circuit

DESIGNATOR	TYPE	VALUE	DESCRIPTION
L1	Resistor	0R	Non-Specific
L2	Inductor	22nH	Murata LQG15HN series
C1	Capacitor	1.8pF	Murata GJM15 series
L3	Inductor	39nH	Murata LQG15HN series
L4	Inductor	6.8nH	Murata LQG15HN series

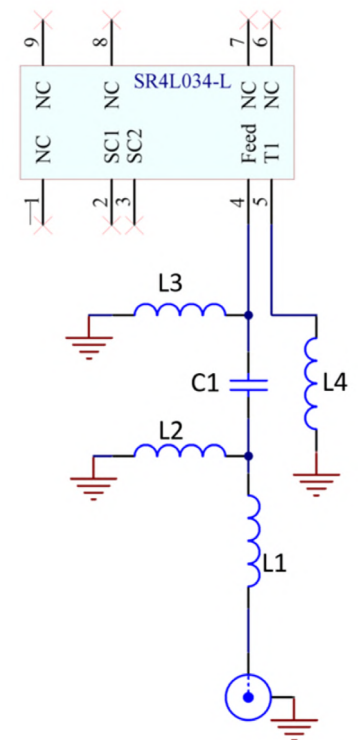

13. Soldering

This antenna is suitable for lead free soldering. The reflow profile should be adjusted to suit the device, oven and solder paste, while observing the following conditions:

- For leaded soldering, the maximum temperature should not exceed 240 °C.
- For lead free soldering, a maximum temperature of 255 °C for no more than 20 seconds is permitted.
- The antenna should not be exposed to temperatures exceeding 120 °C more than 3 times during the soldering process.

14. Hazardous material regulation conformance

The antenna has been tested to conform to RoHS and REACH requirements. A certificate of conformance is available from Antenova's website.

15. Packaging

15.1. Optimal storage conditions

TEMPERATURE	-10°C to 40°C
HUMIDITY	Less than 75% RH
SHELF LIFE	24 Months
STORAGE PLACE	Away from corrosive gas and direct sunlight
PACKAGING	Reels should be stored in unopened sealed manufacturer's plastic packaging.
MSL LEVEL	1

Note: Storage of open reels of antennas is not recommended due to possible oxidization of pads on antennas. If short term storage is necessary, then it is highly recommended that the bag containing the antenna reel is re-sealed and stored in conditions as described in the table above.

The shelf life of the antenna is 2 years provided the factory seal on the package has not been broken.

15.2. Tape characteristics

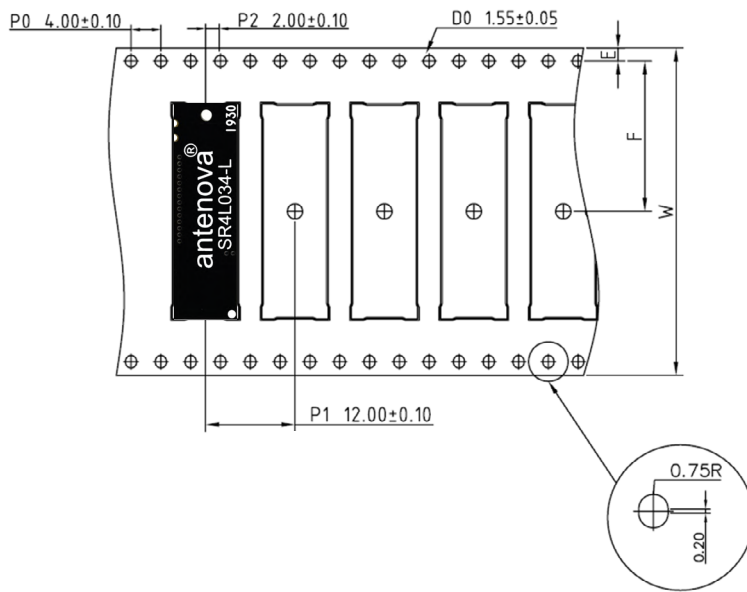

P0	P1	P2	D0
4.00 ± 0.1	12.00 ± 0.1	2.00 ± 0.1	1.55 ± 0.1

E	F	W
1.75 ± 0.1	20.20 ± 0.15	44.00 ± 0.3

All dimensions in (mm)

QUANTITY	LEADING SPACE	TRAILING SPACE
1000 pcs / reel	30 blank antenna holders	30 blank antenna holders

15.3. Reel dimensions

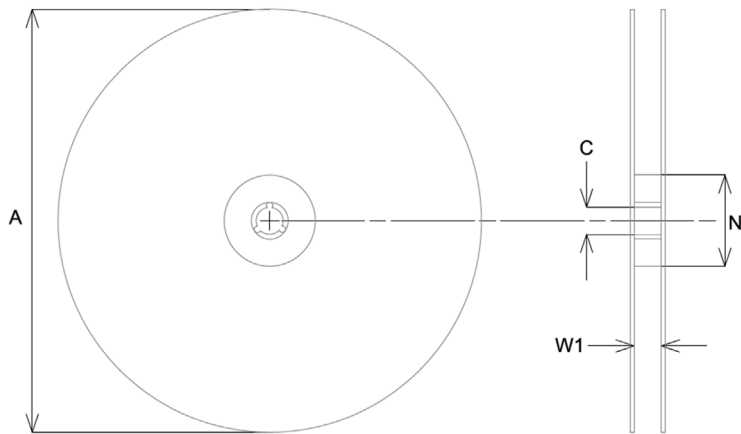

A	C	N	W1
330.0 ± 2.0	13.0 ± 0.5	178.0 ± 0.2	44 ± 0.3

All dimensions in (mm)

15.4. Box dimensions

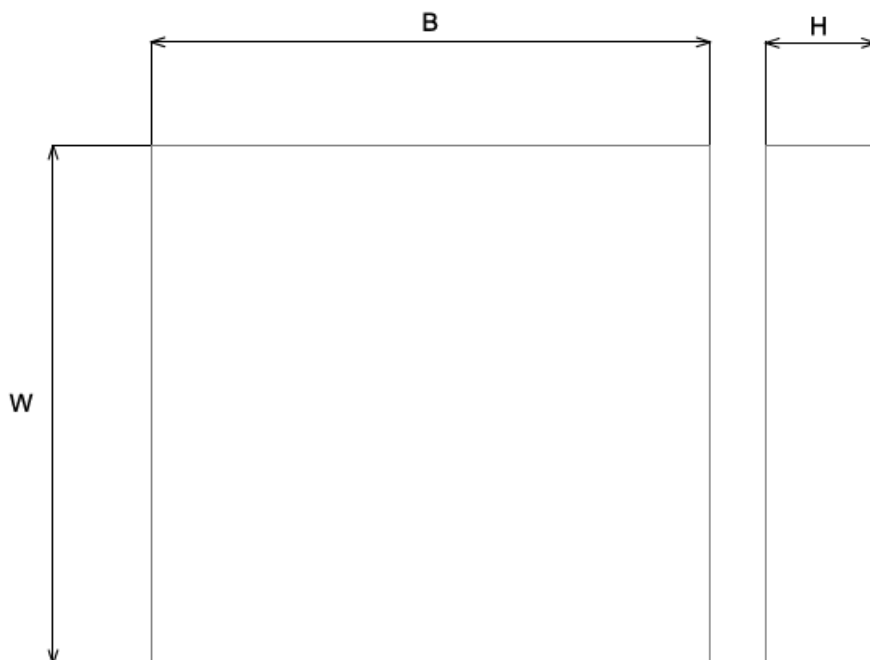

WIDTH (W)	BREADTH (B)	HEIGHT (H)
350mm	340mm	65mm

15.5. Bag properties

Reels are supplied in protective plastic packaging.

15.6. Reel label information

antenuva® Antenuva Limited

www.antenuva.com

Description: Inversa Left 

Part Number: SR4L034-L 

Qty: 1,000 pcs 

Date Code: YYWW 





lamiiANT®

antenuva® Antenuva Limited

www.antenuva.com

Description: Inversa Right 

Part Number: SR4L034-R 

Qty: 1,000 pcs 

Date Code: YYWW 



lamiiANT®

Quality statements

Antenuva’s products conform to REACH and RoHS legislation. For our statements regarding these and other quality standards, please see antenuva.com.



Antenuva reserves all rights to the contents of this document. Antenuva gives no warranties based solely on the accuracy or completeness of the contents of this document and reserves the right to make changes to the specifications of the products described herein at any time and without notice.

Datasheet version

2.01 released Mar 18th 2021

2.02 released May 26th 2021

2.03 released Aug 31st 2021

2.04 released Apr 22th 2022