

## 1. Features

- Antenna for 2.4GHz applications
- Bluetooth, Wi-Fi, ZigBee, ISM.
- Maintains high performance on device: DFI (Designed for Integration)
- Ultra-low profile innovative design.
- SMD mounting
- Supplied on Tape and Reel
- Automotive temperature rating.

## 2. Description

Serica is intended for use with 2.4GHz applications. The antenna only requires a small ground plane. It is ideal for single and MIMO antenna systems. This product specification shows the performance of the antenna over the frequency range 2.4 – 2.5GHz.

## 3. Applications

- Wearable devices
- Medical equipment
- Tablets
- Network Devices
- MIMO Systems
- IP Cameras
- Access Points

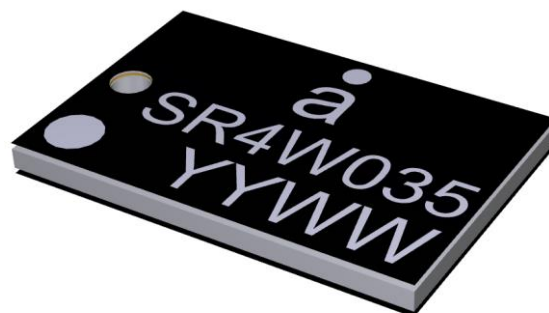

## 4. Part Number

Serica: SR4W035



## 5. General Data

Product name	Serica
Part Number	SR4W035
Frequency	2.4 – 2.5 (GHz)
Polarization	Linear
Operating temperature	-40°C to 140°C
Environmental Condition Test	ISO16750-4 5.1.1.1/5.1.2.1/5.3.2
Impedance with matching	50 $\Omega$
Weight	<1g
Antenna type	SMD
Dimensions	6.0 x 4.0 x 0.4 (mm)

## 6. RF Characteristics

	2400 - 2500 MHz	Conditions
Peak gain	3.50dBi	All data measured on Antenova's evaluation PCB Part No. SR4W035-EVB-1
Average gain (Linear)	-1.50dBi	
Average efficiency	>65%	
Maximum return loss	-10.0dB	
Maximum VSWR	1.85:1	

## 7. RF Performance

### 7.1 Return Loss

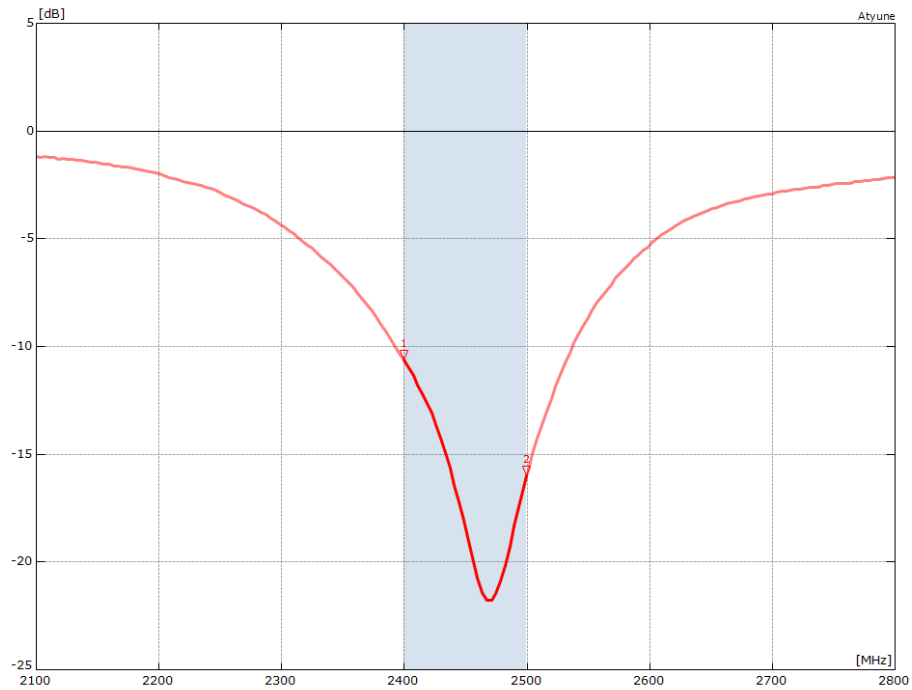

### 7.2 VSWR

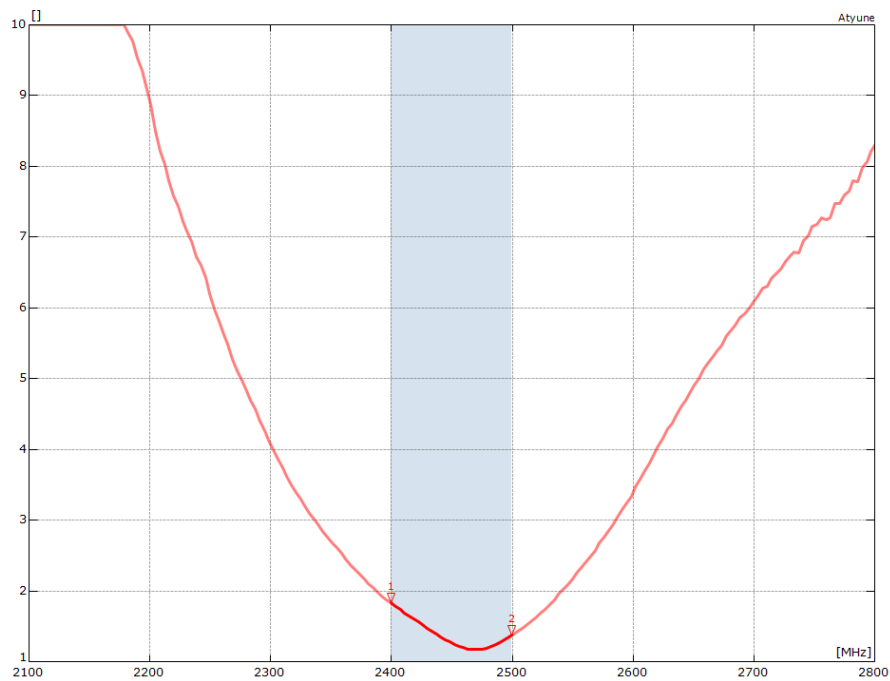

## 7.3 Antenna pattern

### 2400 MHz – 2500 MHz

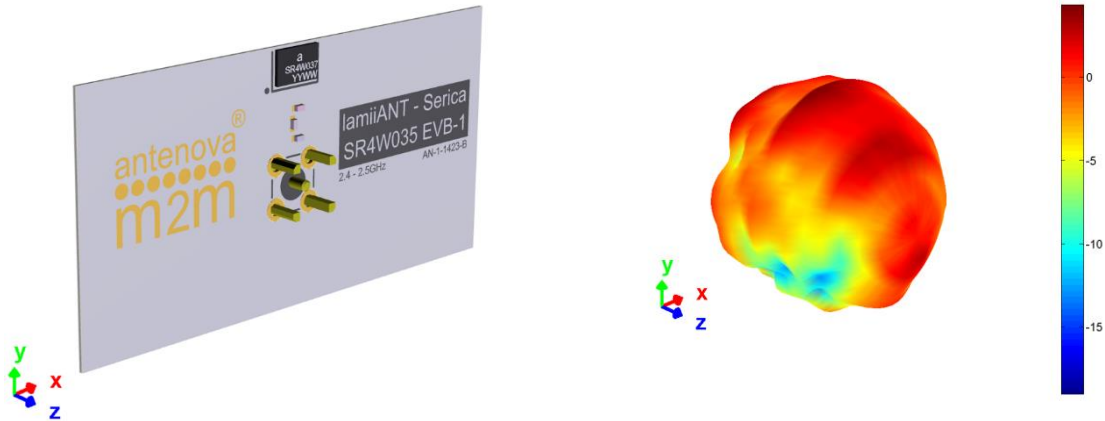

#### 3D pattern at 2.45 GHz

Drag to rotate pattern and PCB by using Adobe Reader  
(Click to Activate)

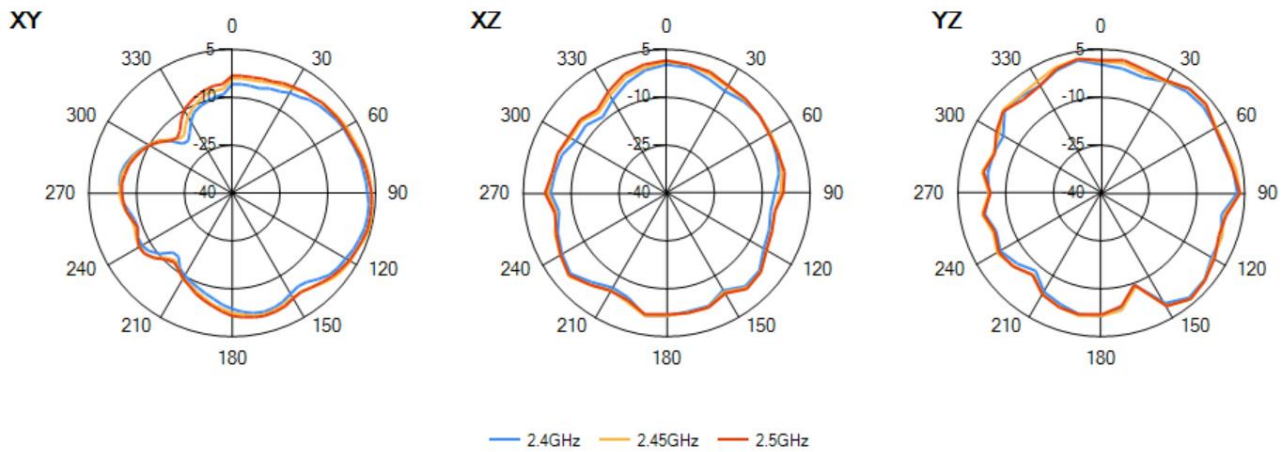

## 8. Antenna Dimensions

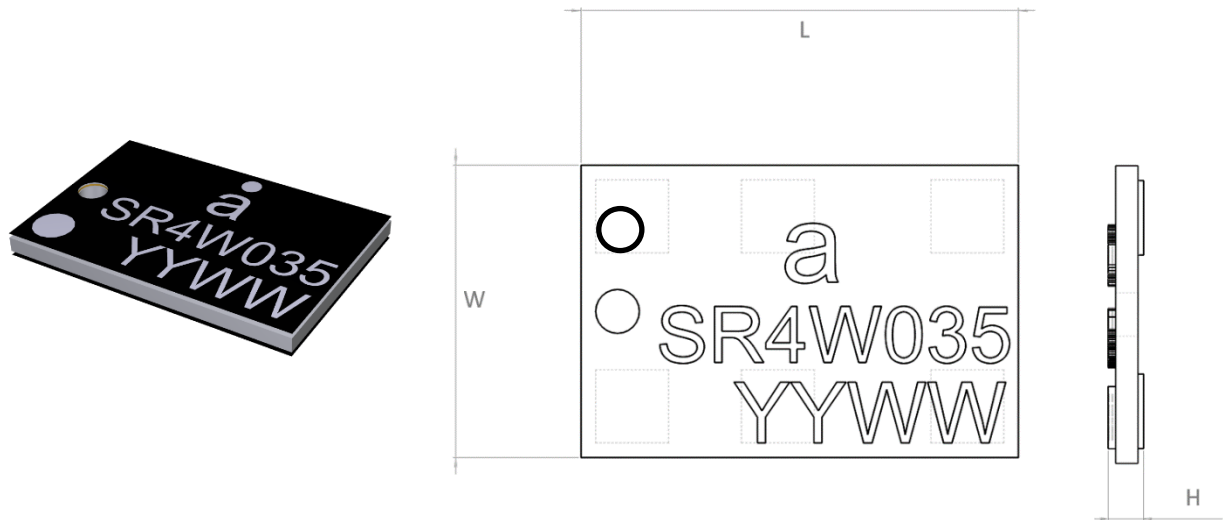

L	W	H
Length	Width	Height
6.0 ±0.1	4.0 ±0.1	0.4 +0.1 -0.0

All Dimensions in (mm)

### Bottom Side Dimensions

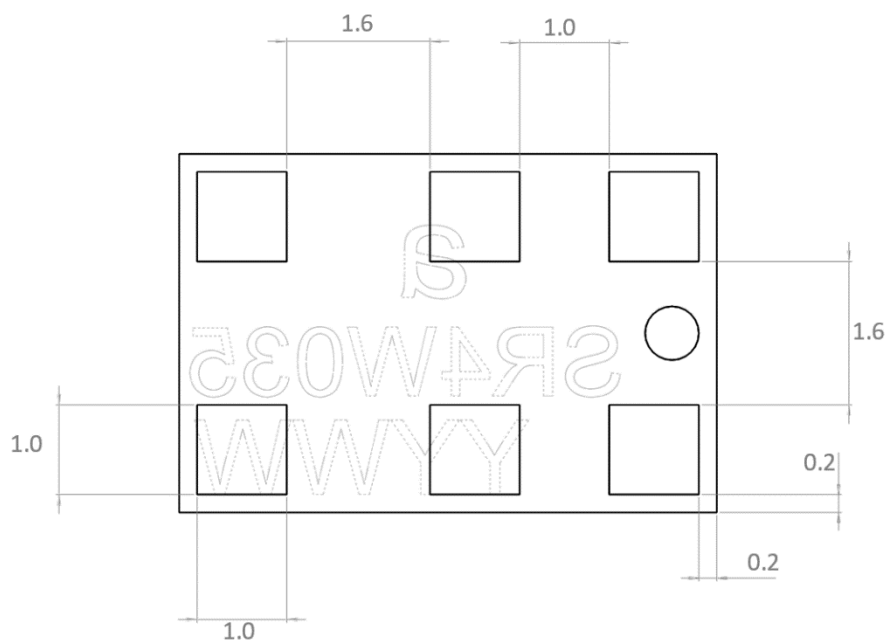

## 9. Schematic symbol and Pin definition

The circuit symbol for the antenna is shown below. The antenna has 6 pins with only two as functional. All other pins are for mechanical strength.

Pin	Description
2	Feed
3,4,6	Return/GND
1,5	Not used (Mechanical only)

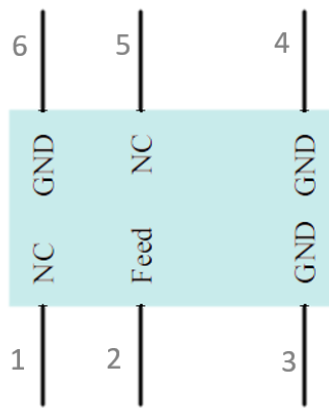

Serica Schematic Symbol

## 10. Antenna footprint

The recommended host PCB footprint is below.

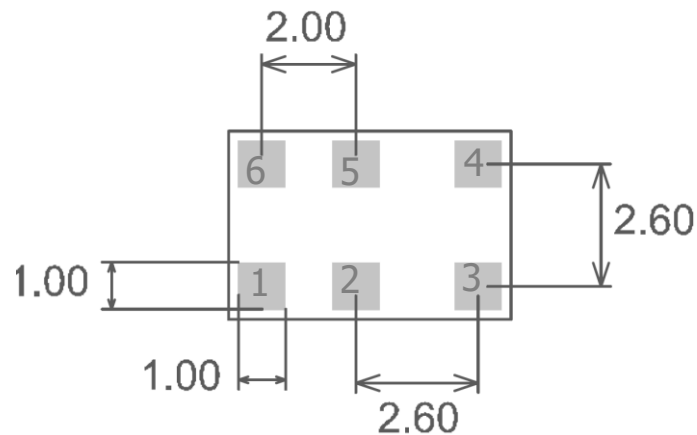

6 copper pads all 1.0 x 1.0 (mm)

## 11. Electrical Interface

### 11.1 Transmission Line

All transmission lines should be designed to have a characteristic impedance of  $50\Omega$ .

- The length of the transmission lines should be kept to a minimum.
- Any other parts of the RF system like transceivers, power amplifiers, etc, should also be designed to have an impedance of  $50\Omega$ .

Once the material for the PCB has been chosen (PCB thickness and dielectric constant), a coplanar transmission line can easily be designed using any of the commercial software packages for transmission line design. For the chosen PCB thickness, copper thickness and substrate dielectric constant, the program will calculate the appropriate transmission line width and gaps on either side of the track, so the characteristic impedance of the co-planar transmission is  $50\Omega$ .

### 11.2 Matching Circuit

The antenna requires a matching circuit that must be optimized for each product. The matching circuit will require up to five components and the following circuit should be designed into the host PCB. Not all components may be required but should be included as a precaution. The matching network must be placed close to the antenna feed to ensure it is more effective in tuning the antenna.

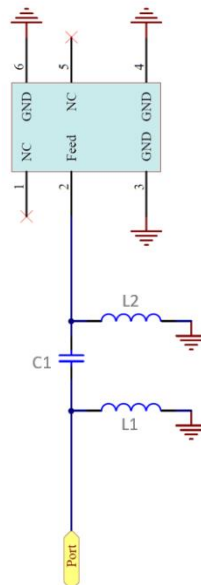

## 12. Antenna Integration Guide

### 12.1 Antenna Placement

Whichever size host PCB is used, the antenna should ideally be placed on the host PCB's longest edge at the centre.

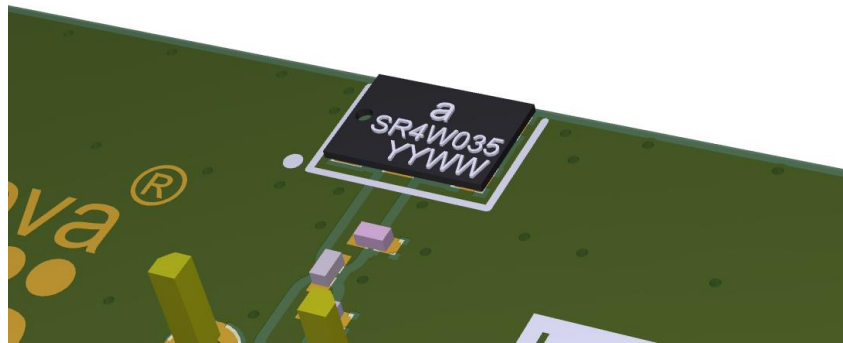

Where the centre is not a viable option, the antenna can be placed offset on the PCB to within the limits shown below. A minimum of 6mm from either PCB edge should be observed. Where possible this distance should be greater than 6mm.

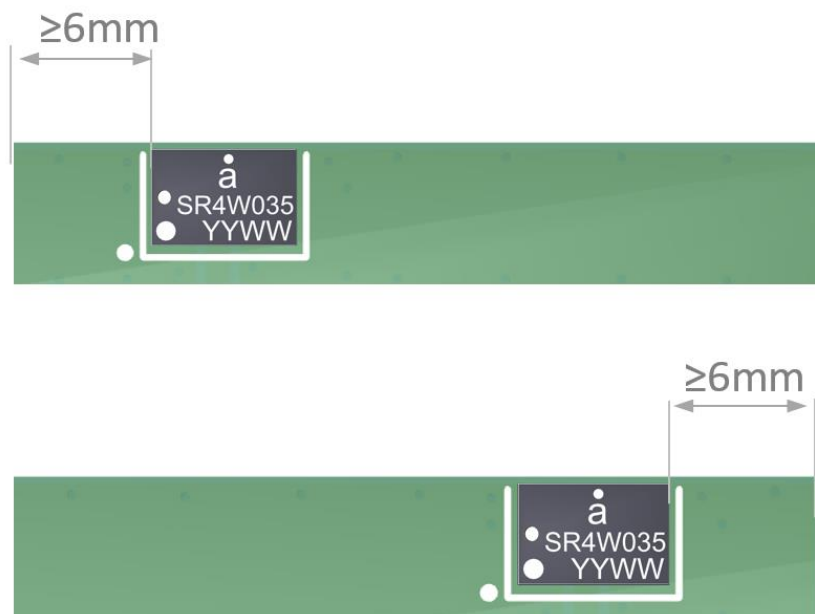



## 12.2 Host PCB Layout

The footprint and clearance of the host PCB must meet the antenna specification. An example of the PCB layout, below, shows the antenna footprint with clearance. Pins 3, 4 and 6 (GND) are shown directly connecting to the GND with the shortest route. The feed (Pin 2) connects to the matching circuit close to the antenna.

Example host layout

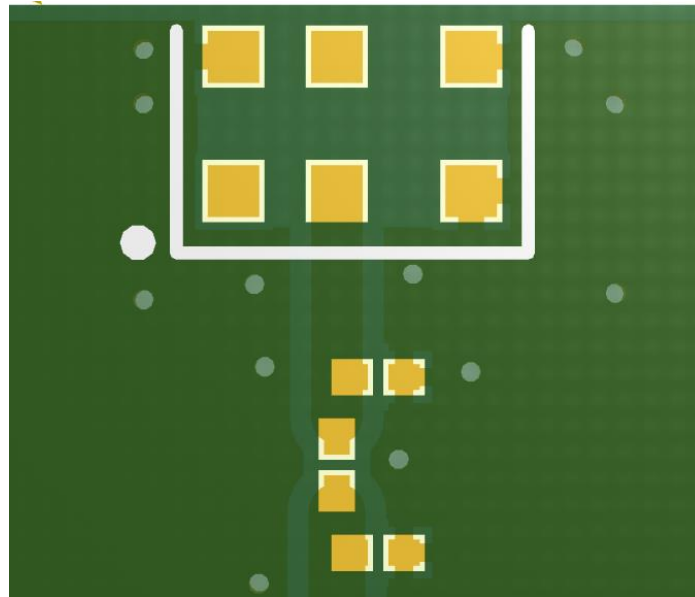

## 12.3 Host PCB Clearance

The diagram below shows the antenna footprint and clearance through all layers on the PCB. Only the antenna pads and connections to feed and GND are present within this clearance area. The clearance area required is 6.0 x 4.0 (mm).

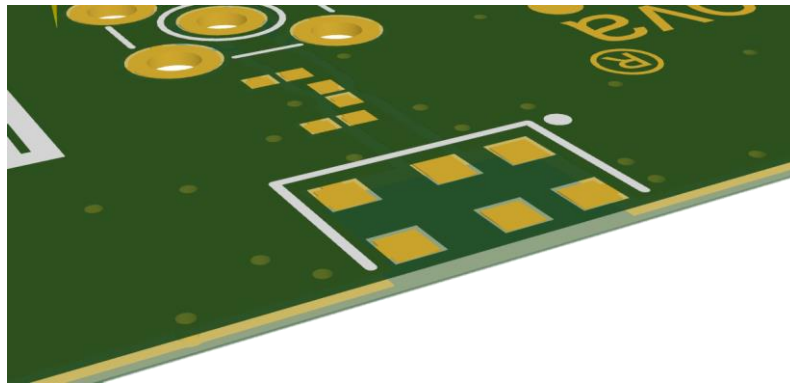

The clear-out area is simply defined as the same size as the antenna. No additional clearance is required.

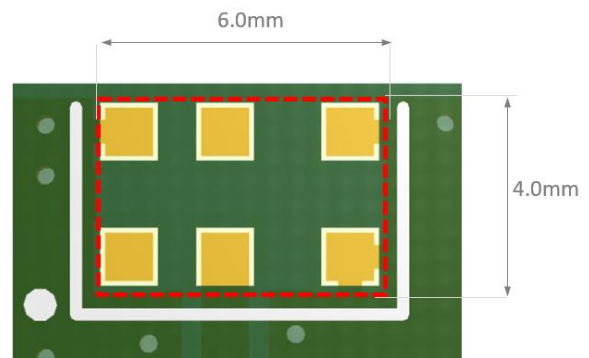
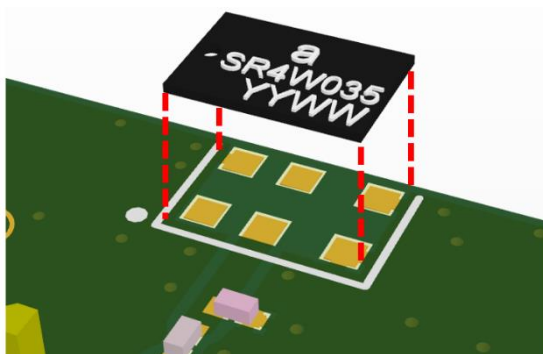

----- Clearance area

### 13. Reference Board

The reference board has been designed for the purpose of evaluating SR4W035 and includes an SMA female connector.

SR4W035-EVB-1 Evaluation Board



To order a reference board please see [www.antenova.com](http://www.antenova.com)

## 13.1 Reference Board Matching Circuit

The reference board has been designed for the purposes of evaluating SR4W035 and includes an SMA female connector.

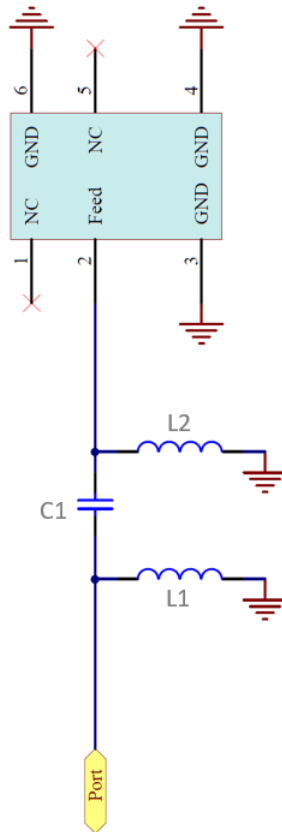

Designator	Type	Value	Description
L1	Not Fitted	Not Fitted	Not Fitted
L2	Inductor	2.2nH	Murata LQG15HN series or equivalent
C1	Capacitor	1.5pF	Murata GRM15HS series or equivalent

## 14. Soldering

This antenna is suitable for lead free soldering. The reflow profile should be adjusted to suit the device, oven and solder paste, while observing the following conditions:

- The maximum temperature should not exceed 240 °C.
- However for lead free soldering, a maximum temperature of 255 °C for no more than 20 seconds is permitted.
- The antenna should not be exposed to temperatures exceeding 120 °C more than 3 times during the soldering process.

## 15. Hazardous Material Regulation Conformance

The antenna has been tested to conform to RoHS requirements. A certificate of conformance is available from Antenova's website.

## 16. Packaging

### 16.1 Optimal Storage Conditions

Temperature	-10°C to 40°C
Humidity	Less than 75% RH
Shelf life	24 Months
Storage place	Away from corrosive gas and direct sunlight
Packaging	Reels should be stored in unopened sealed manufacturer's plastic packaging.

**Note: Storage of open reels of antennas is not recommended due to possible oxidization of pads on antennas. If short term storage is necessary, then it is highly recommended that the bag containing the antenna reel is re-sealed and stored in like storage conditions as in above table.**

## 16.2 Tape Characteristics

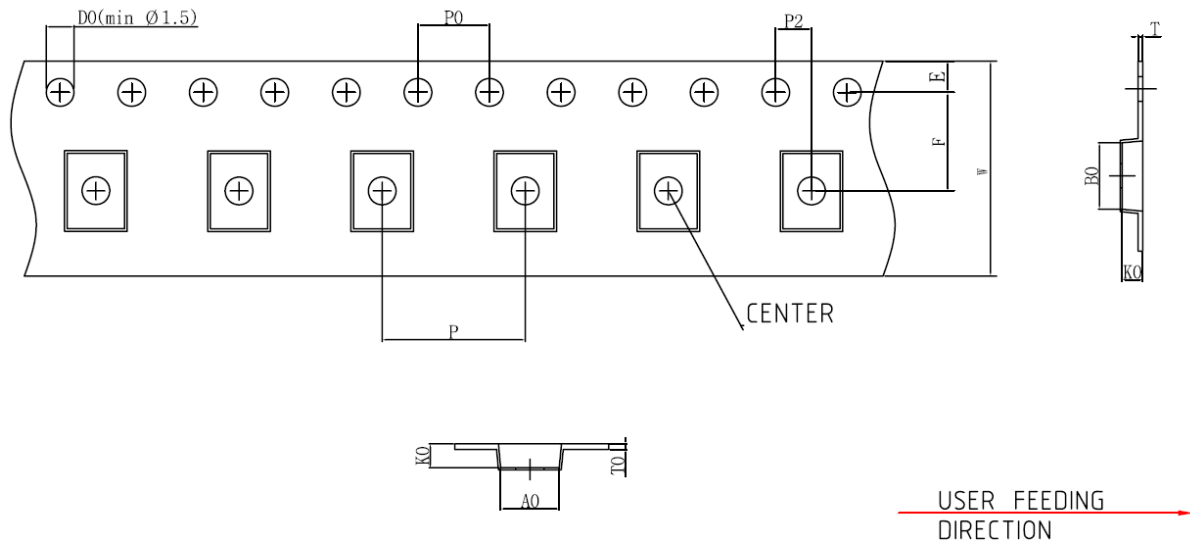

Ko	Ao	Bo	P0	P1	P2
0.95 ± 0.1	4.20 ± 0.1	6.20 ± 0.1	4.00 ± 0.1	8.00 ± 0.1	2.00 ± 0.1

E	F	W
1.75 ± 0.1	7.50 ± 0.15	12.00 ± 0.3

Dimensions in mm

### Notes:

- 1) 10 sprocket hole pitch cumulative tolerance ±0.2
- 2) Camber not to exceed 1mm in 100mm
- 3) Ao and Bo measured on a plane 0.1mm above the bottom of the pocket
- 4) Ko measured from a plane on the inside bottom of the pocket to the top surface of the carrier

### 16.3 Reel Dimensions

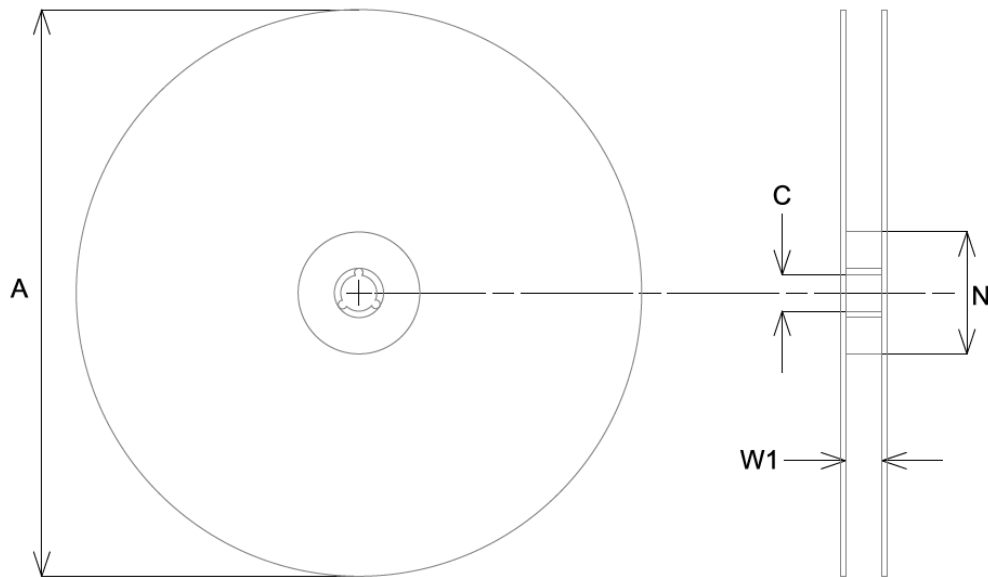

A	C	N	W1
178.0 ± 2.0	13.50 ± 0.5	60.0 ± 0.2	13.0 ± 0.3

All dimensions in mm

## 16.4 Box Dimensions

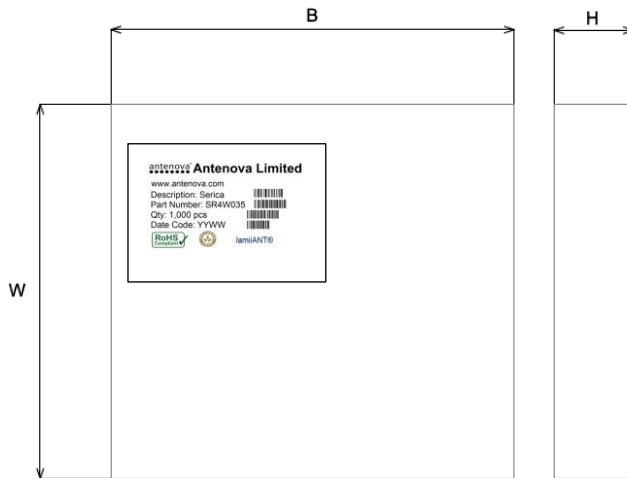

Width (W)	Breadth (B)	Thickness (H)
203mm	188mm	40mm

## 16.5 Bag Properties

Reels are supplied in protective plastic packaging.

## 16.6 Reel Label Information

