

**SCHOTTKY BARRIER RECTIFIER**

**VOLTAGE RANGE 20 to 200 Volts CURRENT 5.0 Amperes**

**FEATURES**

- \* High reliability
- \* Low switching loss
- \* Low forward voltage drop
- \* High current capability
- \* High switching capability

**MECHANICAL DATA**

- \* Epoxy: Device has UL flammability classification 94V-O
- \* Case: Molded plastic
- \* Lead: MIL-STD-202E method 208C guaranteed
- \* Mounting: position: Any
- \* Weight: 1.18 grams

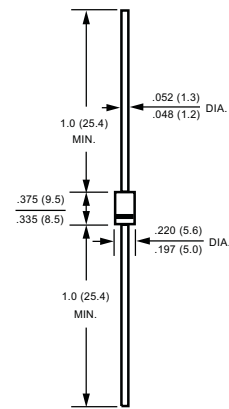

**MAXIMUM RATINGS AND ELECTRICAL CHARACTERISTICS**

Ratings at 25 °C ambient temperature unless otherwise specified.  
resistive or inductive load.

**MAXIMUM RATINGS (@ TA=25 °C unless otherwise noted)**

RATINGS	SYMBOL	SR520	SR530	SR540	SR550	SR560	SR580	SR5100	SR5150	SR5200	UNITS
Maximum Recurrent Peak Reverse Voltage	V <sub>RRM</sub>	20	30	40	50	60	80	100	150	200	Volts
Maximum RMS Voltage	V <sub>RMS</sub>	14	21	28	35	42	56	70	105	140	Volts
Maximum DC Blocking Voltage	V <sub>DC</sub>	20	30	40	50	60	80	100	150	200	Volts
Maximum Average Forward Rectified Current at Derating Lead Temperature	I <sub>O</sub>	5.0									Amps
Peak Forward Surge Current 8.3 ms single half sine-wave superimposed on rated load (JEDEC method)	I <sub>FSM</sub>	150									Amps
Typical Current Squared Time	I <sup>2</sup> T	93.3									A <sup>2</sup> S
Typical Thermal Resistance (Note 1)	R <sub>θJA</sub>	25									°C/W
	R <sub>θJL</sub>	8									
Typical Junction Capacitance (Note 3)	C <sub>J</sub>	200									pF
Operating Temperature Range	T <sub>J</sub>	150									°C
Storage Temperature Range	T <sub>STG</sub>	-55 to + 150									°C

**ELECTRICAL CHARACTERISTICS (@TA=25 °C unless otherwise noted)**

CHARACTERISTICS	SYMBOL	SR520	SR530	SR540	SR550	SR560	SR580	SR5100	SR5150	SR5200	UNITS
Maximum Instantaneous Forward Voltage at 5.0A DC	V <sub>F</sub>	.55			.75		.85				Volts
Maximum Average Reverse Current at Rated DC Blocking Voltage	I <sub>R</sub>	@T <sub>A</sub> = 25°C									mA
		@T <sub>A</sub> = 100°C									mA

- NOTES : 1. Thermal Resistance : At 9.5mm lead lengths, PCB mounted.  
2. Measured at 1 MHz and applied reverse voltage of 4.0 volts. □  
3. "Fully ROHS compliant", "100% Sn plating (Pb-free)".

## RATING AND CHARACTERISTICS CURVES ( SR520 THRU SR5200 )

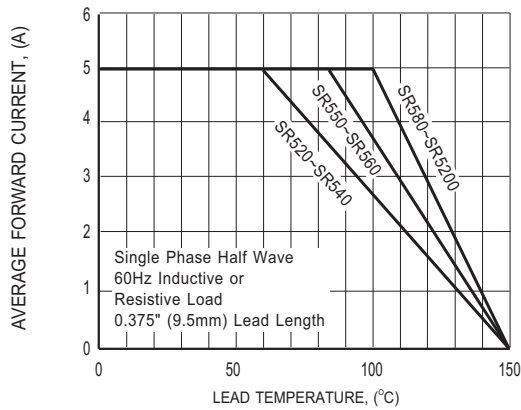

FIG.1 TYPICAL FORWARD CURRENT DERATING CURVE

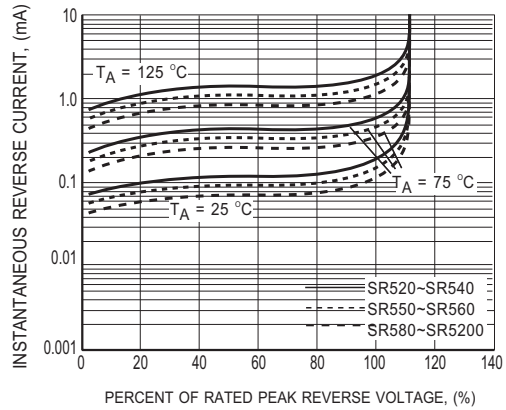

FIG.2 TYPICAL REVERSE CHARACTERISTICS

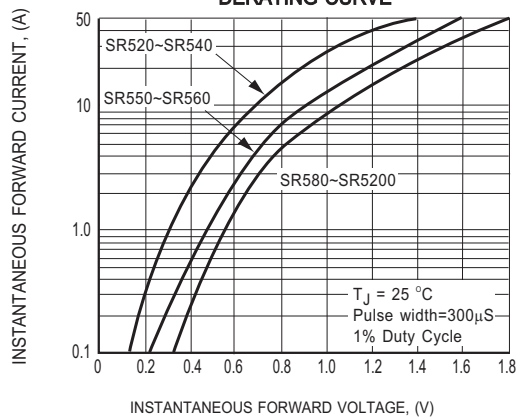

FIG.3 TYPICAL INSTANTANEOUS FORWARD CHARACTERISTICS

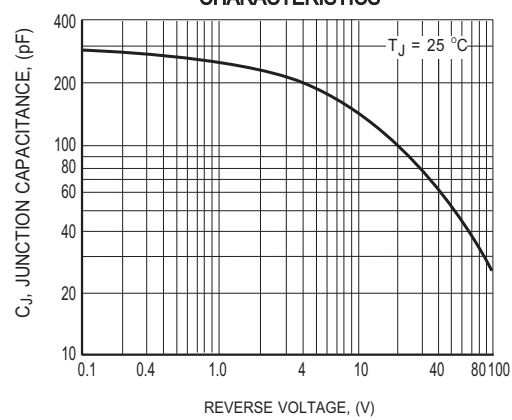

FIG.4 TYPICAL JUNCTION CAPACITANCE

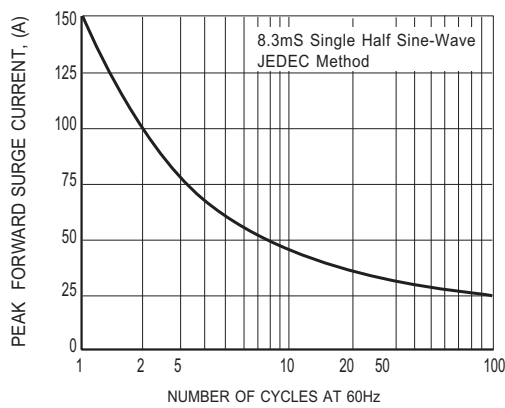
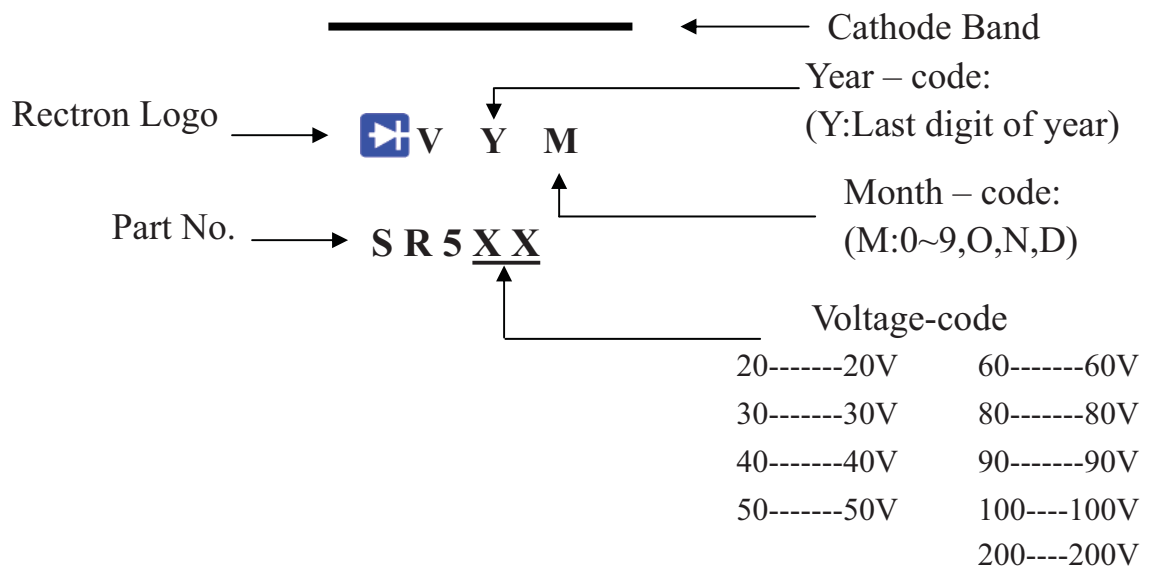

FIG.5 MAXIMUM NON-REPETITIVE FORWARD SURGE CURRENT

## Marking Description



## PACKAGING OF DIODE AND BRIDGE RECTIFIERS

### BULK PACK

PACKAGE	PACKING CODE	EA PER BOX	INNER BOX SIZE (mm)	CARTON SIZE (mm)	EA PER CARTON	GROSS WEIGHT(Kg)
DO-201	-B	500	300*73*40	347*320*271	12,000	15.9

### REEL PACK

PACKAGE	PACKING CODE	EA PER REEL	EA PER INNER BOX	COMPONENT SPACE (mm)	TAPE SPACE (mm)	REEL DIA (mm)	CARTON SIZE (mm)	EA PER CARTON	GROSS WEIGHT(Kg)
DO-201	-T	1,200	1,200	5.0	52	330	355*350*335	4,800	9.10

### AMMO PACK

PACKAGE	PACKING CODE	REEL ( EA )	COMPONENT SPACE(mm)	TAPE SPACE (mm)	BOX SIZE (mm)	CARTON SIZE(mm)	CARTON ( EA )	GROSS WEIGHT (Kg)
DO-201	-F	600	9.5	52	255*73*100	400*268*225	6,000	9.9