

Schottky Barrier Rectifier

FEATURES

- Low power loss, high efficiency
- Guardring for overvoltage protection
- High surge current capability
- Compliant to RoHS Directive 2011/65/EU and in accordance to WEEE 2002/96/EC
- Halogen-free according to IEC 61249-2-21 definition



MECHANICAL DATA

Case: TO-220AC

Molding compound, UL flammability classification rating 94V-0

Base P/N with suffix "G" on packing code - halogen-free

Base P/N with prefix "H" on packing code - AEC-Q101 qualified

Terminal: Matte tin plated leads, solderable per JESD22-B102

Meet JESD 201 class 1A whisker test,

with prefix "H" on packing code meet JESD 201 class 2 whisker test

Polarity: As marked

Mounting torque: 5 in-lbs maximum

Weight: 1.86 g (approximately)

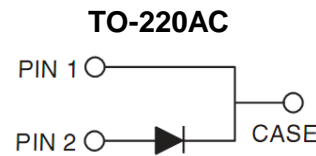

MAXIMUM RATINGS AND ELECTRICAL CHARACTERISTICS (T _A =25°C unless otherwise noted)									
PARAMETER	SYMBOL	SRA 1620	SRA 1630	SRA 1640	SRA 1650	SRA 1660	SRA 1690	SRA 16100	UNIT
Maximum repetitive peak reverse voltage	V _{RRM}	20	30	40	50	60	90	100	V
Maximum RMS voltage	V _{RMS}	14	21	28	35	42	63	70	V
Maximum DC blocking voltage	V _{DC}	20	30	40	50	60	90	100	V
Maximum average forward rectified current	I _{F(AV)}	16							A
Peak forward surge current, 8.3 ms single half sine-wave superimposed on rated load	I _{FSM}	200							A
Maximum instantaneous forward voltage (Note 2) IF=16A	V _F	0.55		0.70		0.92		V	
Maximum reverse current @ rated VR T _J =25 °C T _J =100 °C T _J =125 °C	I _R	0.5					0.1		mA
		15			10		-		
		-					5		
Typical thermal resistance	R _{θJC}	5							°C/W
Operating junction temperature range	T _J	- 55 to +125			- 55 to +150				°C
Storage temperature range	T _{STG}	- 55 to +150							°C

Note 1: Pulse test with PW=300µs, 1% duty cycle

ORDERING INFORMATION					
PART NO.	AEC-Q101 QUALIFIED	PACKING CODE	GREEN COMPOUND CODE	PACKAGE	PACKING
SRA16xx (Note 1)	Prefix "H"	C0	Suffix "G"	TO-220AC	50 / Tube

Note 1: "xx" defines voltage from 20V (SRA1620) to 100V (SRA16100)

EXAMPLE					
PREFERRED P/N	PART NO.	AEC-Q101 QUALIFIED	PACKING CODE	GREEN COMPOUND CODE	DESCRIPTION
SRA1660 C0	SRA1660		C0		
SRA1660 C0G	SRA1660		C0	G	Green compound
SRA1660HC0	SRA1660	H	C0		AEC-Q101 qualified

RATINGS AND CHARACTERISTICS CURVES

(TA=25°C unless otherwise noted)

FIG. 1 FORWARD CURRENT DERATING CURVE

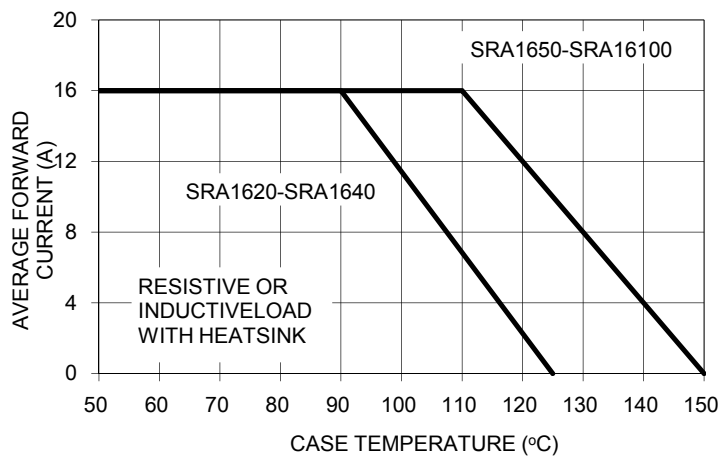

FIG. 2 MAXIMUM NON-REPETITIVE FORWARD SURGE CURRENT

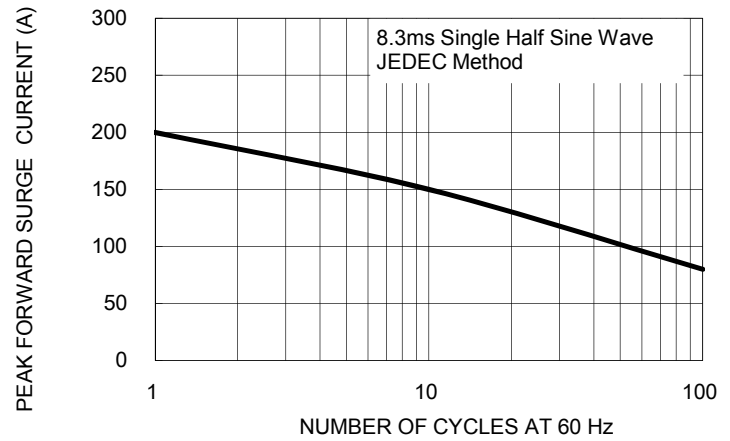

FIG. 3 TYPICAL FORWARD CHARACTERISTICS

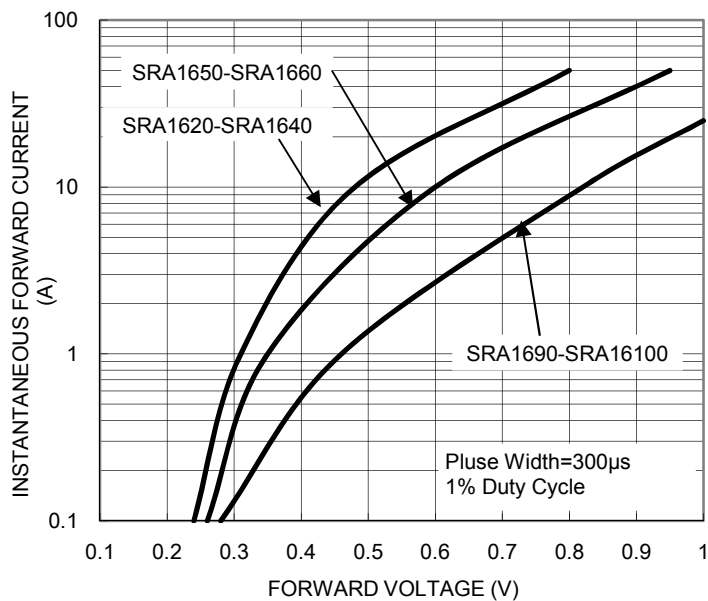

FIG. 4 TYPICAL REVERSE CHARACTERISTICS

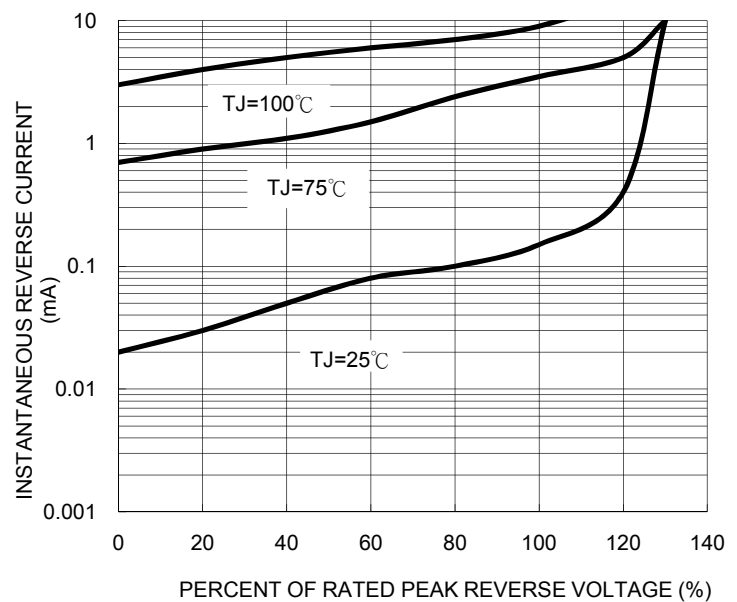

FIG. 5 TYPICAL JUNCTION CAPACITANCE

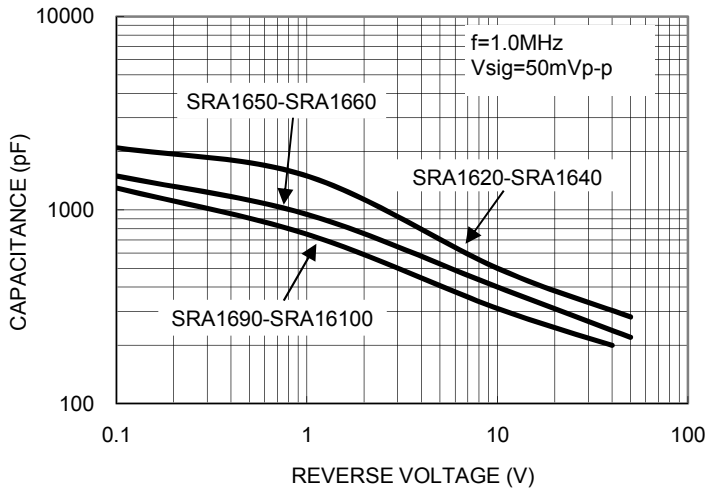
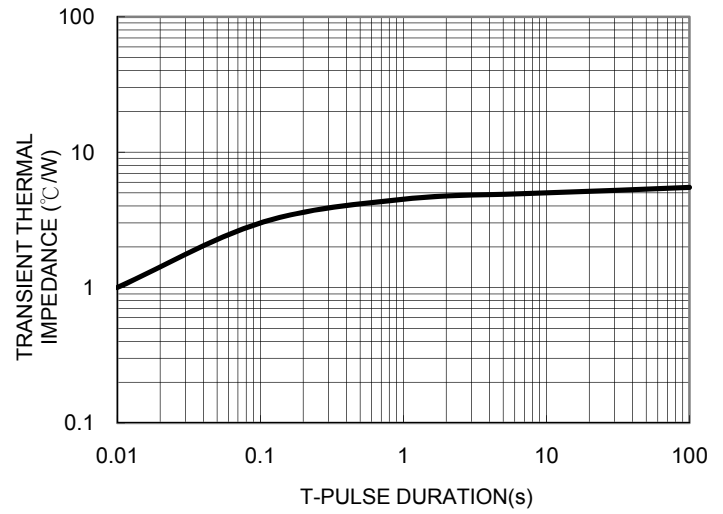
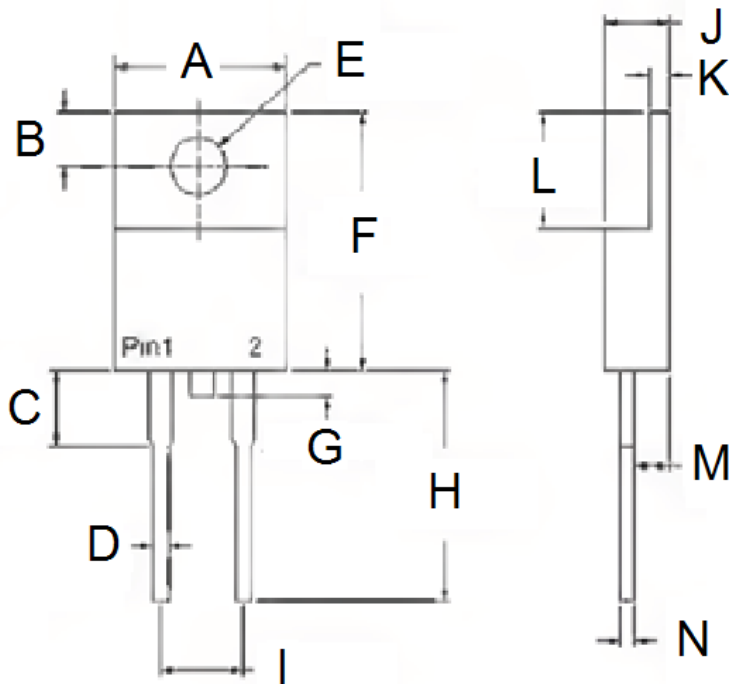

FIG. 6 TYPICAL TRANSIENT THERMAL IMPEDANCE



PACKAGE OUTLINE DIMENSIONS



DIM.	Unit (mm)		Unit (inch)	
	Min	Max	Min	Max
A	-	10.50	-	0.413
B	2.62	3.44	0.103	0.135
C	2.80	4.20	0.110	0.165
D	0.68	0.94	0.027	0.037
E	3.54	4.00	0.139	0.157
F	14.60	16.00	0.575	0.630
G	0.00	1.60	0.000	0.063
H	13.19	14.79	0.519	0.582
I	4.95	5.20	0.195	0.205
J	4.42	4.76	0.174	0.187
K	1.14	1.40	0.045	0.055
L	5.84	6.86	0.230	0.270
M	2.20	2.80	0.087	0.110
N	0.35	0.64	0.014	0.025

MARKING DIAGRAM



- P/N = Marking Code
- G = Green Compound
- YWW = Date Code
- F = Factory Code