

1. Features:

- 2.4GHz applications
- Bluetooth, Wi-Fi, Zigbee, ISM.
- Ultra-small ceramic chip solution.
- High Efficiency.
- SMD mounted.
- Resistant to de-tuning.
- Omni-directional
- RoHS compliant

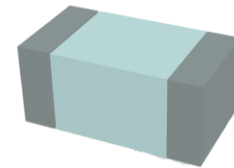

2. Description

For use in all 2.4GHz applications. Compact design with simple integration and implementation. Effective on varying GND plane sizes. Coexists well in multiple antenna systems. Resistant to de-tuning effects means devices can work well in different environments. Ideal antenna choice for small wearable devices.

3. Applications:

- Small wearable devices
- Headsets
- Medical devices
- PNDs
- Dongles
- Sensors

4. Quick Specs:

Part Number	SRCW004
Frequency	2.4 – 2.5GHz
Operating Temp	-40°C to 125°C
Antenna Dimensions	1.0 x 0.5 x 0.5
Antenna Clearance Area	9mm x 4.5mm
Average Efficiency	70%

5. Mechanical Specifications

Product Name	Weii 2.4GHz Chip Antenna
Part Number	SRCW004
Frequency Range	2.4 - 2.5 GHz
Polarization	Linear
Operating Temperature	-40 °C to +125 °C
Weight	<0.015 g
Impedance with matching	50 Ω
Antenna Type	SMD
Dimensions	1.0 x 0.5 x 0.5 (mm)
Footprint Size	9.0 x 4.5 (mm)

6. RF Specifications

	Typical Performance
Peak Gain	2.5 dBi
Average Gain	-1.5 dBi
Average Efficiency	70%
Maximum Return Loss	<-10 dB
Maximum VSWR	1.6:1

Data measured on Antenova's reference PCB.
Data given for the 2.402 – 2.480 GHz frequency range

7. RF Performance

7-1 Return Loss

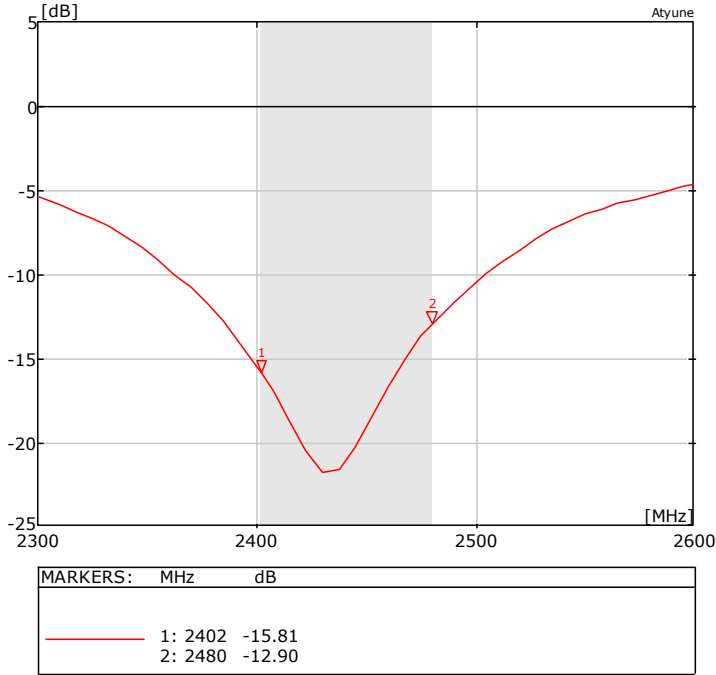

7-2 VSWR

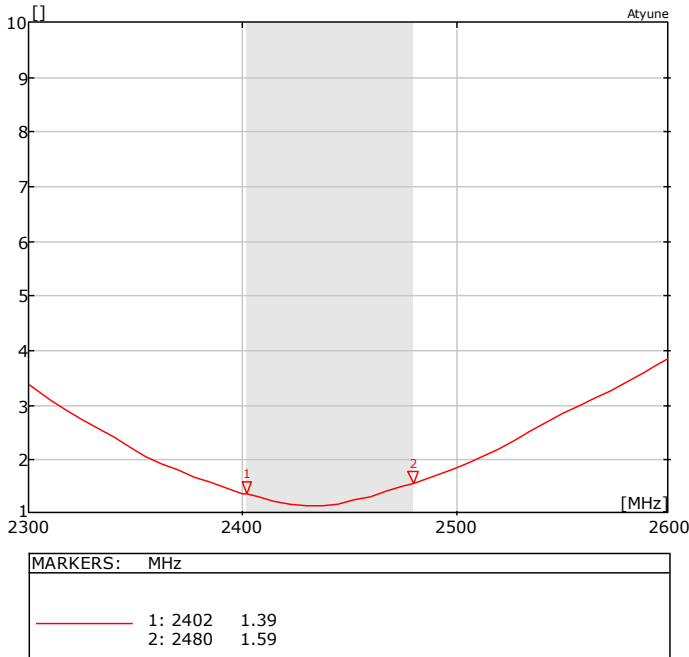

Data measured on Antenova's reference PCB.
 Data given for the 2.402 – 2.480 GHz frequency range

7-3 Radiation Pattern

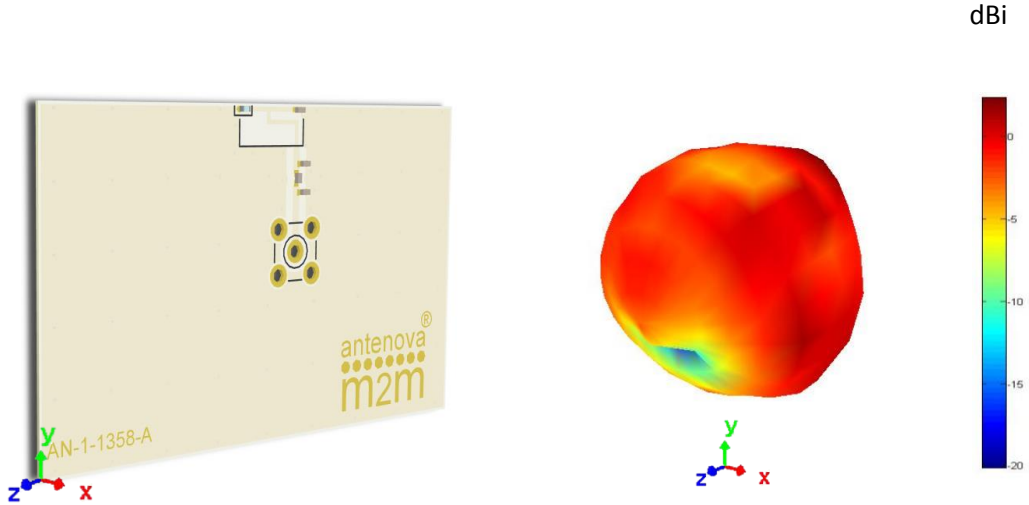

3D pattern at 2.45GHz
 Drag to rotate pattern by using Adobe Reader

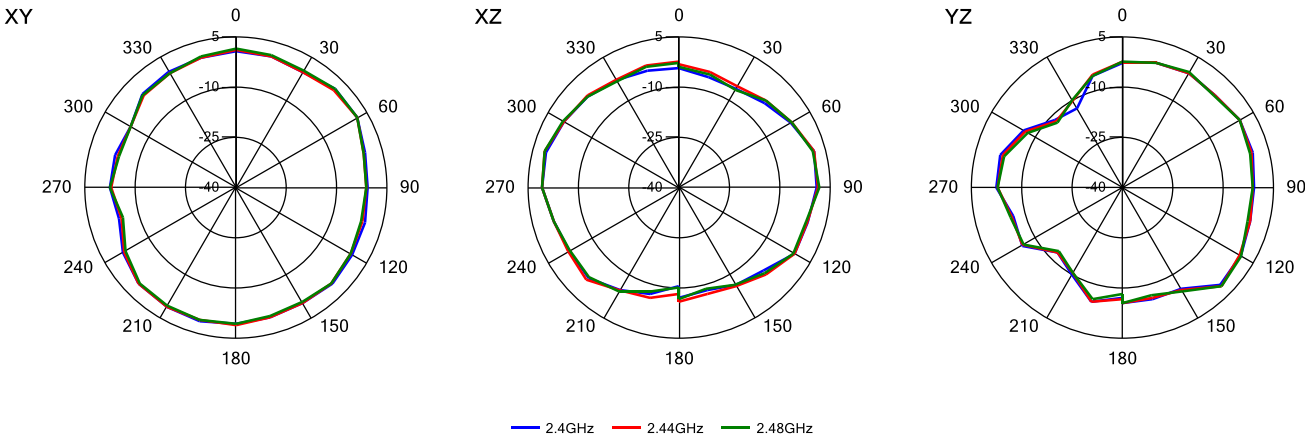

Data measured on Antenova's reference PCB.
 Data given for the 2.402 – 2.480 GHz frequency range

8. Antenna Dimensions

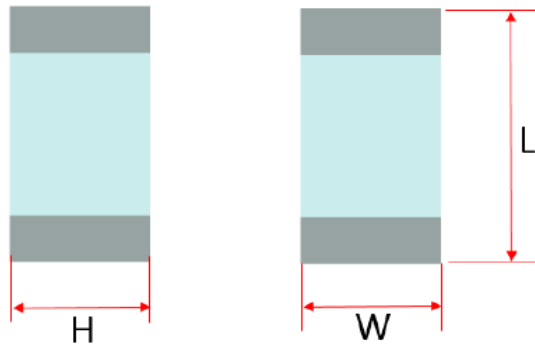
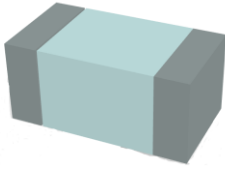

L	W	H
Length	Width	Height
1.0 ± 0.1	0.5 ± 0.15	0.5 ± 0.1

All dimensions in mm

9. Antenna footprint

L	W	P
Length	Width	Pitch
0.6 ± 0.1	0.5 ± 0.15	1.0 ± 0.1

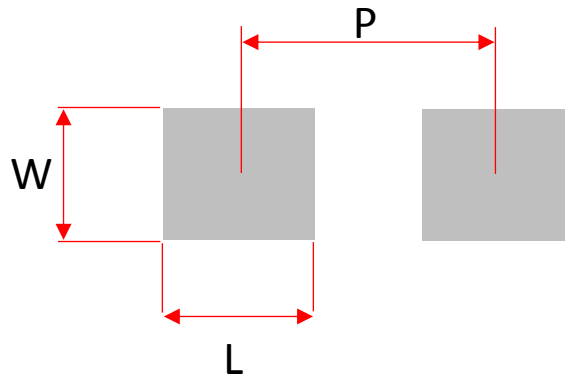

All dimensions in mm

 PCB copper pads

* CAD files of the antenna footprint are available at www.antenova.com.

9-1 Schematic

The circuit required for the antenna is shown here. The RF feed connection and GND connections are critical to the function of the antenna, and must be followed as shown. This circuit can be used for the circuit capture of the host PCB.

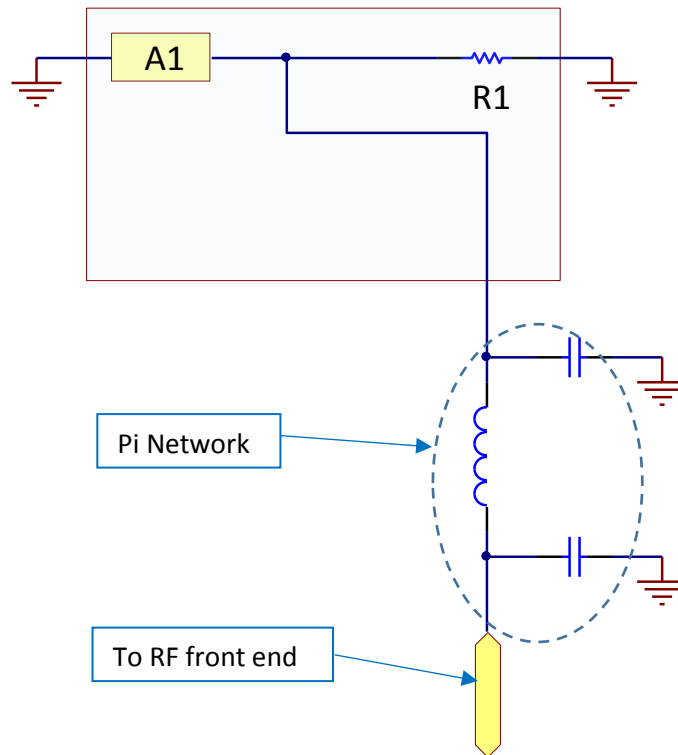

A1	Antenna
R1	Tuning Component (Default = 0R Resistor)

9-2 Antenna host PCB Layout

The copper tracks etched on the PCB form an integral part of the antenna, and any deviation from the advised layout shown below will result in a loss in the antenna performance. It is best that the copper track layout is imported from CAD files which are available from Antenova M2M on request. Please contact info@antenova-m2m.com for further details.

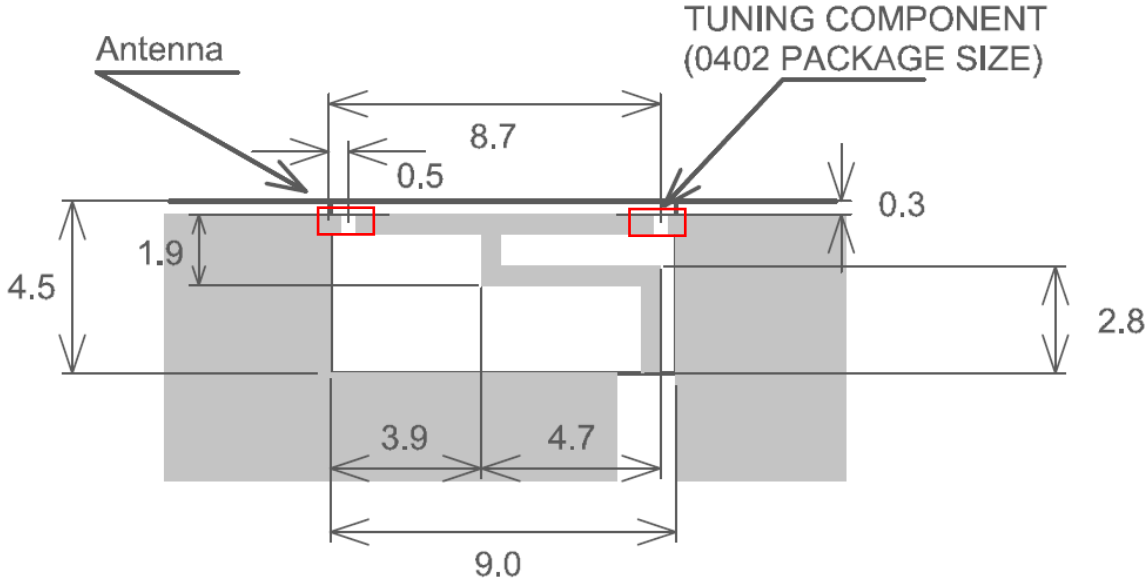

ALL TRACE WIDTHS EQUAL 0.5mm
 ANTENNA CLEARANCE AREA 9 x 4.5mm
 ANTENNA DISTANCE TO PCB EDGE = 0.3mm



ALL DIMENSIONS IN mm

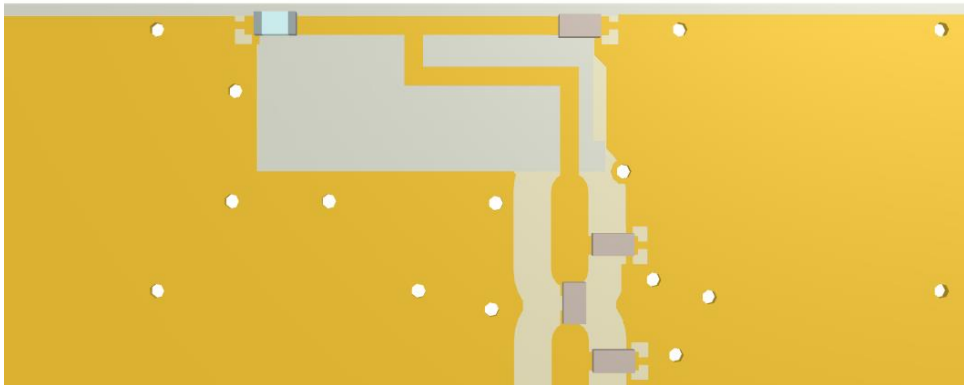

PCB layout without shown without solder mask for illustration purpose.

10 Electrical interface

10-1 Transmission Line

All transmission lines should be designed to have a characteristic impedance of 50Ω

- The length of the transmission lines should be kept to a minimum
- Any other parts of the RF system like transceivers, power amplifiers, etc, should also be designed to have an impedance of 50Ω

Once the material for the PCB has been chosen (PCB thickness and dielectric constant), a coplanar transmission line can easily be designed using any of the commercial software packages for transmission line design. For the chosen PCB thickness, copper thickness and substrate dielectric constant, the program will calculate the appropriate transmission line width and gaps on either side of the track so the characteristic impedance of the coplanar transmission line is 50Ω .

10-2 Matching circuit

The antenna requires a matching circuit that must be optimized for each product. The matching circuit will require up to three components (0402 size), and an additional tuning element is also required (0402 size) the following pad layout should be designed into the device so the correct circuit can be installed.

Note: The tuning component by default is a 0402 zero ohm resistor.

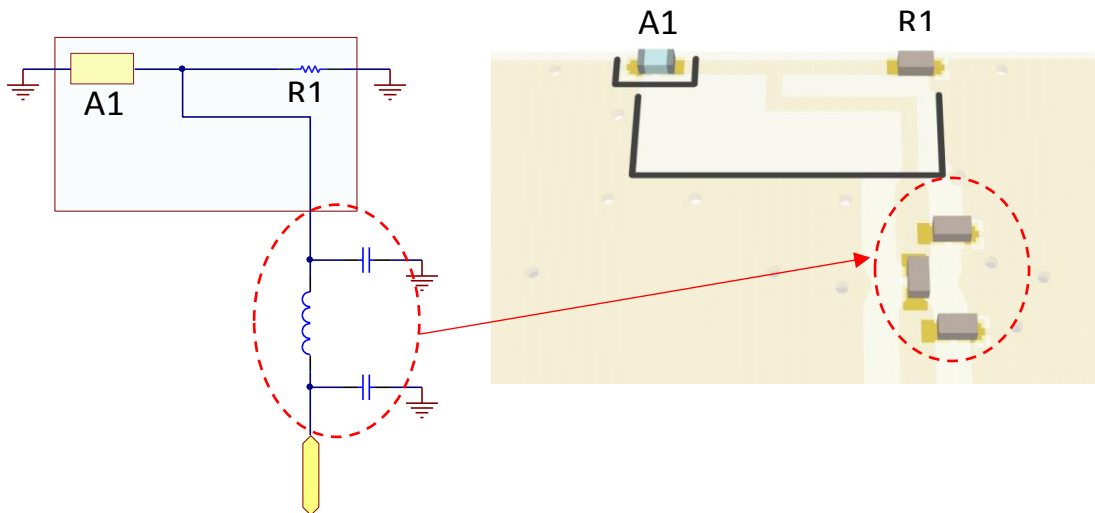

In addition to the matching circuit, a separate DC blocking capacitor will also be required between the radio and the antenna matching circuit.

Note: The component values for the matching circuit will vary depending on the size of the PCB and surrounding components. The impedance of the antenna should be measured before selecting suitable matching components. Antenova M2M offers this service on request. Contact techsupport@antenova-m2m.com or further information.

10-3 Host PCB integration guidelines

Placement

The antenna should be placed in the best suited position to effectively radiate. Whichever the PCB size used, the most ideal position is along the longest edge of the PCB at the centre of that edge.

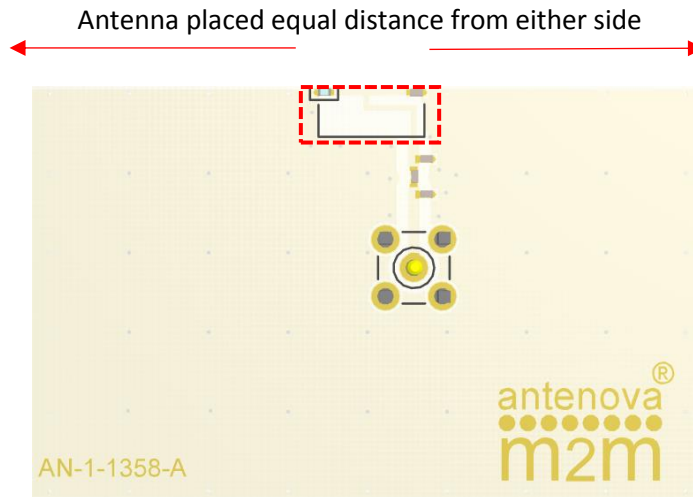

Where the centre is not a viable option the antenna can be placed offset on the PCB to within the limits shown below.

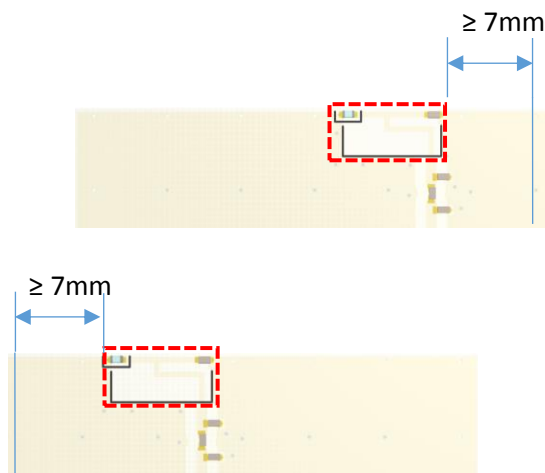

Minimum recommended host PCB size

The recommended minimum PCB size for the antenna is defined by the PCB edge the antenna is to be placed. For good performance to be maintained this minimum size is recommended to be no less than 30mm in length. Below shows the change in performance when the ground plane size is reduced.

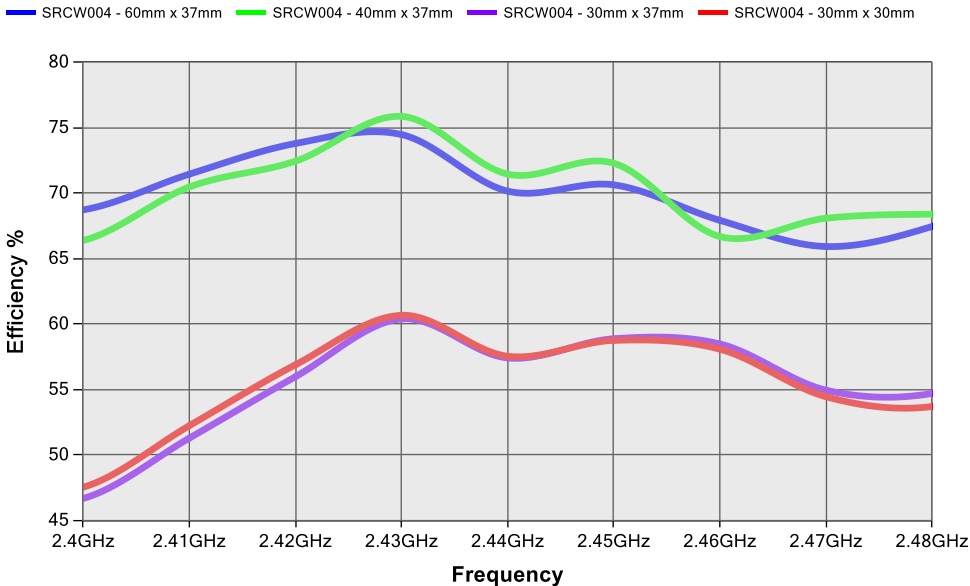
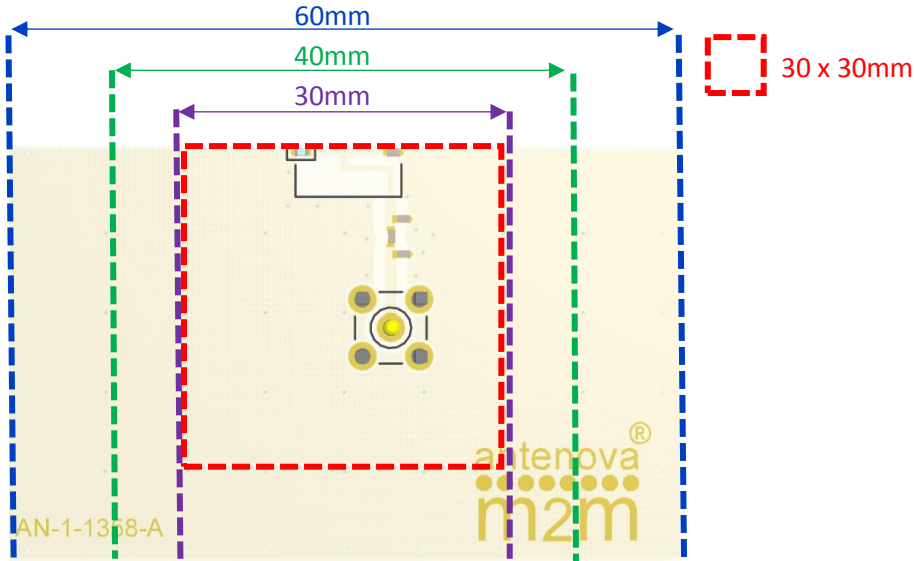

MIMO Applications example

This ceramic antenna is ideal for applications requiring multiple antennas for MIMO systems. In this example two antennas are shown mounted on Antenova evaluation PCB and represents a good example when applying this antenna within a MIMO system.

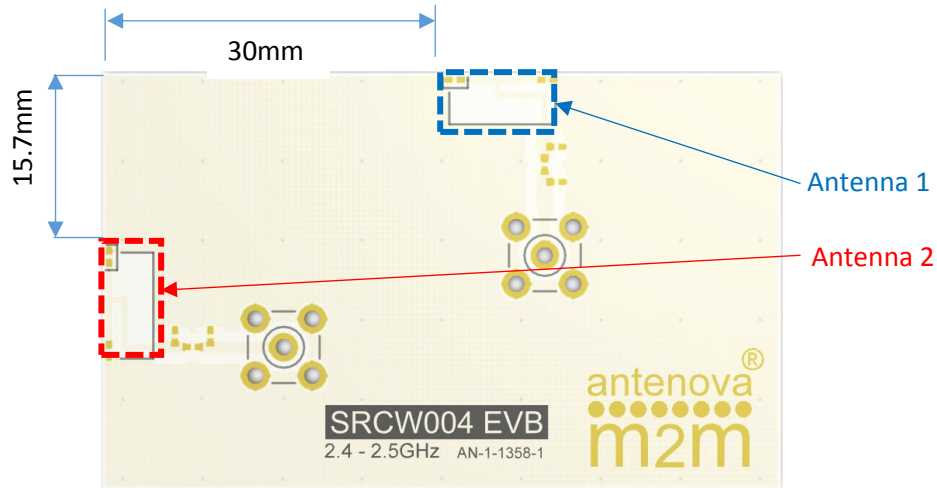

Two antennas placed perpendicular to each other at a distance of 28mm from antenna clearance edges. Both antennas were optimised and matched to the same frequency.

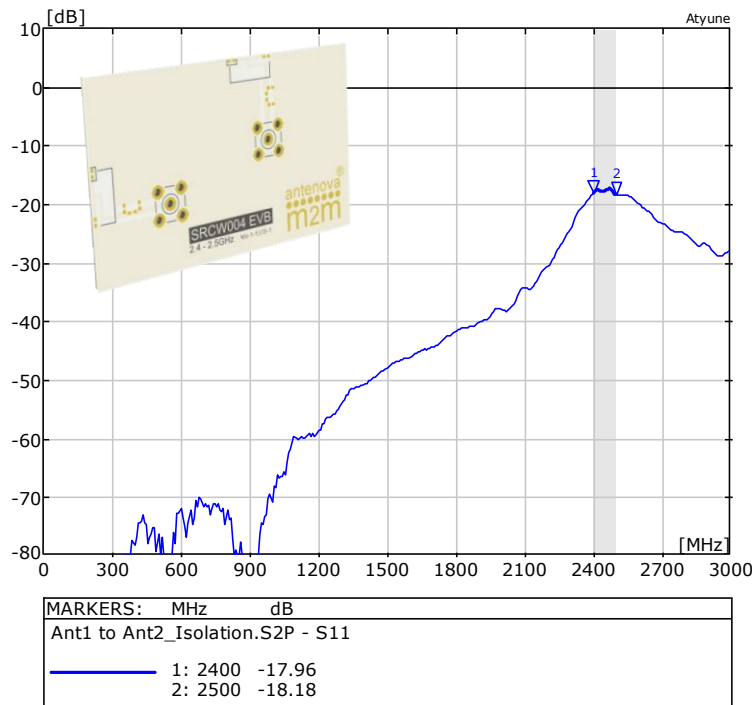

MIMO Applications example

The radiation patterns for the MIMO configuration.

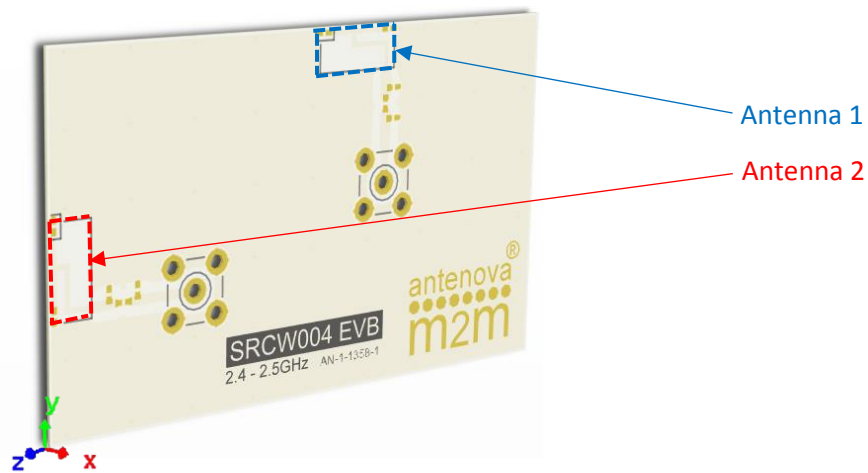

3D patterns at 2.45GHz
Drag to rotate pattern by using Adobe Reader

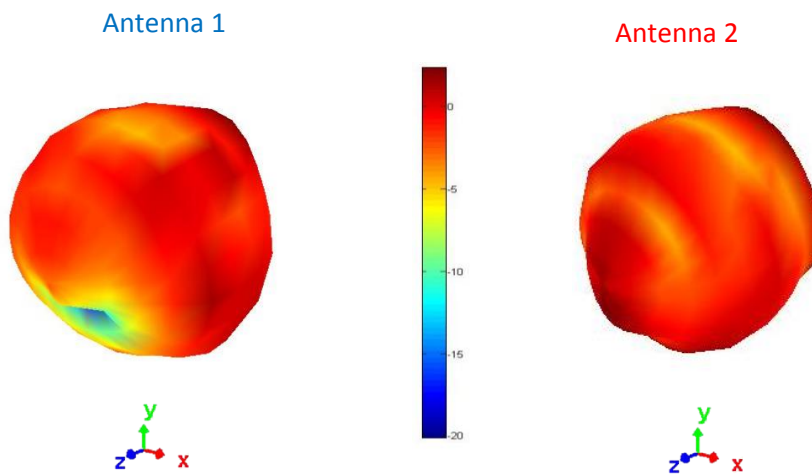

Wearable device example

Wearable devices require the use of small PCB's with limited clearance due to components and close proximity to the human body. Some guidelines to follow when designing small devices are illustrated in the example below.

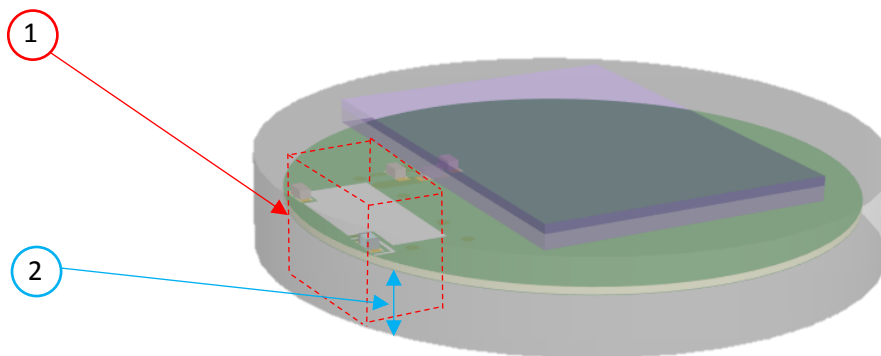
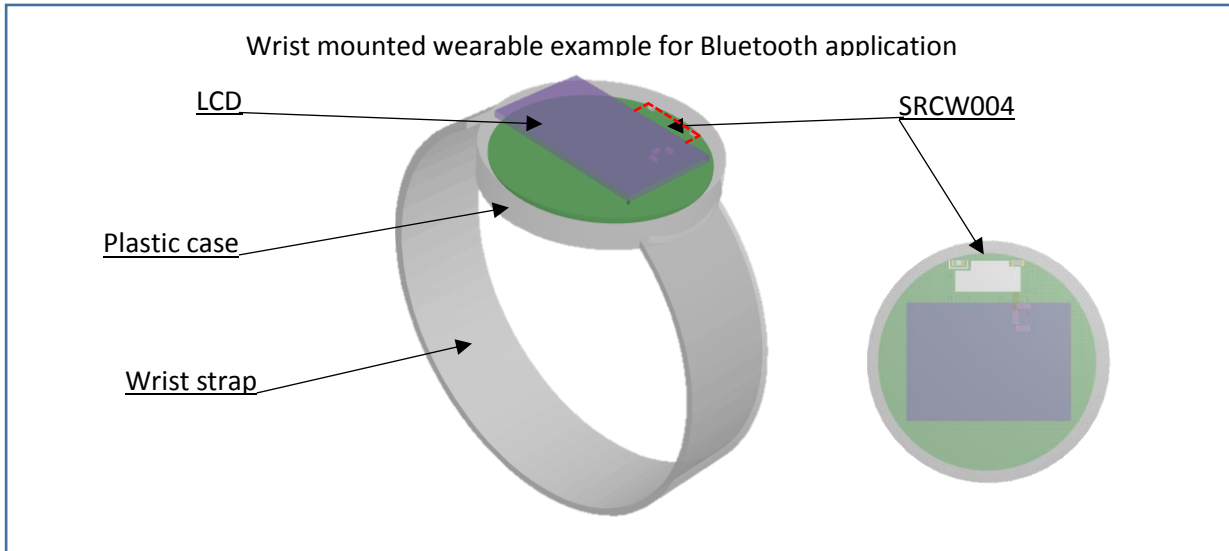

1. Antenna clearance must be maintained above and below, with exception of the human body making contact with the external case.
2. Components such as LCD or Battery to keep clear of antenna section.
3. Place antenna on longest PCB edge, in this case close to edge of the circular PCB.
4. Height from human body should be greater than 4mm to minimise losses (>4mm)
5. Outer case should not contain metal close to the antenna where possible. Certain metalized coatings are possible where they do not conduct effectively.

11. Evaluation PCB

The reference board has been designed for evaluation purposes of SRCW004 2.4 GHz and it includes a SMA female connector.

SRCW004 Evaluation Board



To order a reference board please see www.antenna.com

12. Soldering

This antenna is suitable for lead free soldering.

The reflow profile should be adjusted to suit the device, oven and solder paste, while observing the following conditions:

- The maximum temperature should not exceed 240 °C
- However for lead free soldering, a maximum temperature of 255 °C for no more than 20 seconds is permitted.
- The antenna should not be exposed to temperatures exceeding 120 °C more than 3 times during the soldering process.

13. Hazardous material regulation conformance

The antenna has been tested to conform to RoHS requirements. A certificate of conformance is available from Antenova M2M's website.

14. Packaging

14-1 Optimal storage conditions for packaged reels

Temperature	-10°C to 40°C
Humidity	Less than 75% RH
Shelf Life	24 Months
Storage place	Away from corrosive gas and direct sunlight
Packaging	Reels should be stored in unopened sealed manufacturer's plastic packaging.

Note: Storage of open reels of antennas is not recommended due to possible oxidization of pads on antennas. If short term storage is necessary, then it is highly recommended that the bag containing the antenna reel is re-sealed and stored in like storage conditions as in above table.

The shelf life of the antenna is two years, providing the factory seal on the package has not been broken.

14-2 Tape Dimensions

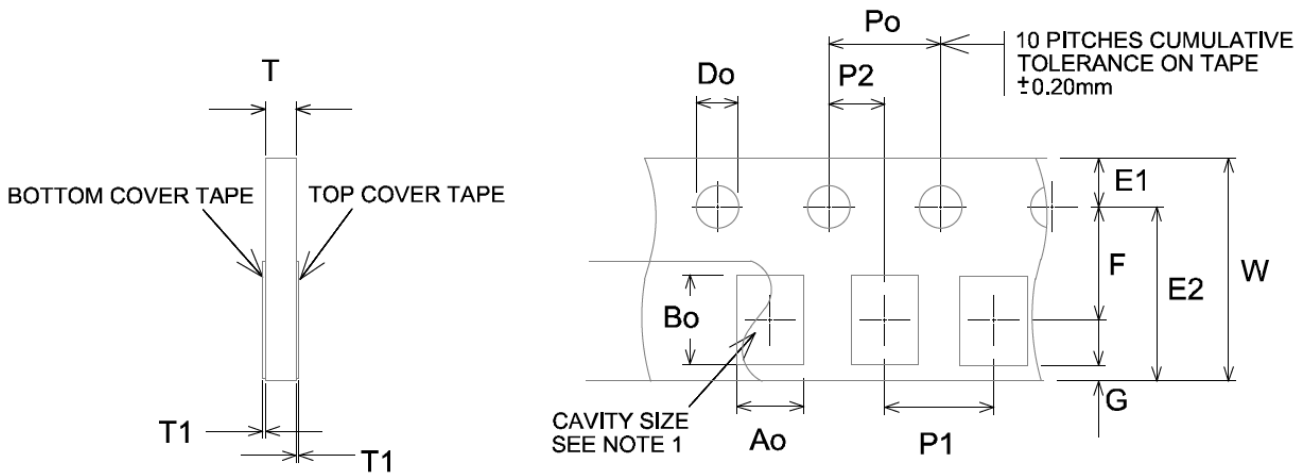

All dimensions in mm

Do	E1	E2	F	G	Po
1.50±0.1	1.75±0.1	6.25±0.1	3.50±0.05	0.75 min	4.00±0.1

P1	P2	T	T1	W	Ao & Bo
4.00±0.1	2.00±0.05	1.10 max	0.1 max	8.00±0.3	See note 1

Notes:

The cavity defined by Ao, Bo, and T shall be configured to provide sufficient clearance surrounding the antenna so that:

- The component does not protrude beyond either surface of the carrier tape.
- The component can be removed from the cavity in a vertical direction without mechanical restriction after the top cover tape has been removed.
- Rotation of the component is limited to 20° maximum.
- Lateral movement of the component is restricted to 0.5mm maximum.

14-3 Reel dimensions

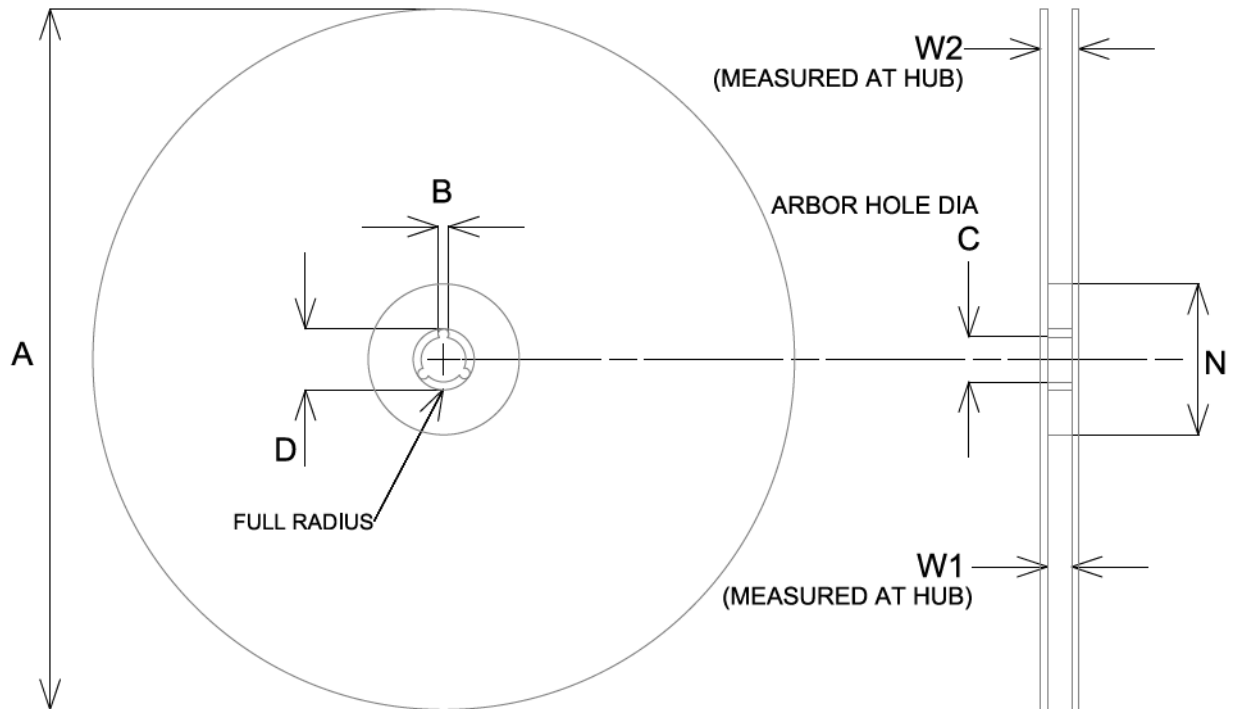

All dimensions in mm

A	B	C	D	W1	W2
330 (max)	1.5 (min)	13.0±0.5	20.2 (min)	8.40 +1.5	14.4 (max)

Quantity	Leading Space	Trailing Space
10000 pcs / reel	16 blank antenna holders	24 blank antenna holders

14-4 Box dimensions

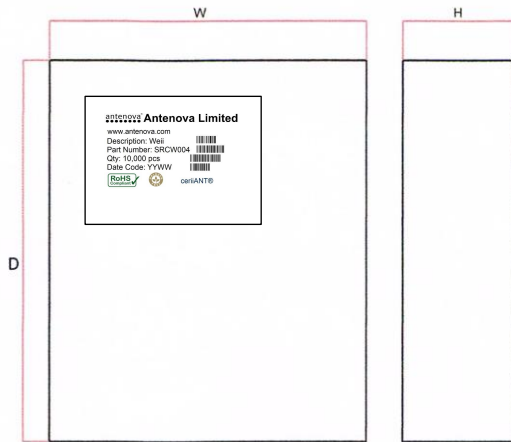

Width W	Breadth B	Thickness H
340 mm	350 mm	47 mm

14-5 Bag properties

Reels are supplied in protective plastic packaging.

14-6 Reel label information

