

1. Features

- Terminal antenna for 4G/3G/2G applications
- LTE, HSPA+, WCDMA, CDMA, GSM, GPRS, DCS1800, PCS1900
- LTE bands: 1-21; 23-30; 33-41
- 698-960MHz, 1427-1660MHz, 1710-2170MHz, 2300-2400MHz, 2500-2690MHz
- High performance dipole design
- Available in three terminal options: swivel, fly lead and fixed 90° (IP67)

2. Description

Draco is constructed with an ergonomic blade design to blend well to the outside of a device. Three versions are available, including an IP67 design for outdoor applications. The antenna is designed to work to various GND plane sizes or in free space for ease of integration.

3. Applications

- Routers
- Industrial devices
- Remote devices
- ISM

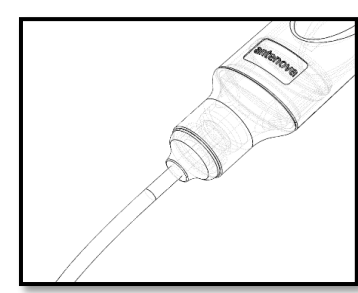
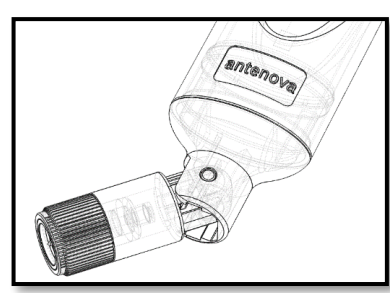

4. Part Number

Note. -xxx refers to options for antenna version, connector type and cable length:

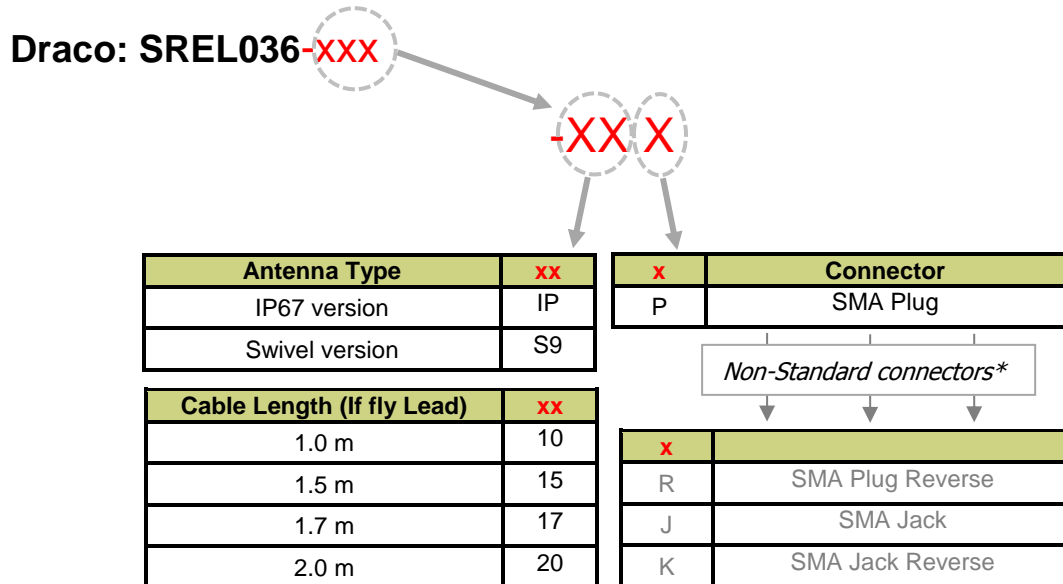

*Please contact Antenova for details on non-standard connector types



5. General Data

Product name	Draco
Part Number	SREL036-xxx
Frequency	698-960 MHz 1427-1660MHz 1720-2170MHz 2300-2400MHz 2500-2690MHz
Polarization	Linear
Operating temperature	-20°C to +70°C
Impedance with matching	50 Ω
Weight	< 21g (Cable not included)
Dimensions (Antenna)	See dimensions from page 18>
Cable length (Fly lead only)	1.0m /2.0m *
Connection	SMA Plug (Standard)
Radome Material	PC

*Please contact Antenova for details on other cable lengths

6. RF Characteristics

The RF characteristics are shown for each type.

	698 – 960 MHz		
	Fixed (IP67)	Hinged	Fly Lead (1.0m)
			
Peak gain	2.46dBi	2.18dBi	1.23dBi
Average gain	-2.26dBi	-2.32dBi	-3.10dBi
Average efficiency	>55%	>56%	>45%
Maximum return loss	<-5.30dB	<-5.56dB	<-6.65dB
Maximum VSWR	3.30:1	3.25 :1	2.60:1

	1420 – 1660 MHz		
	Fixed (IP67)	Hinged	Fly Lead (1.0m)
Peak gain	2.07dBi	1.92dBi	1.23dBi
Average gain	-2.63dBi	-2.59dBi	-3.38dBi
Average efficiency	>53%	>55%	>48%
Maximum return loss	<-7.50dB	<-7.50dB	<-14.90dB
Maximum VSWR	2.40:1	2.40:1	1.40:1

	1720 – 2170 MHz		
	Fixed (IP67)	Hinged	Fly Lead (1.0m)
Peak gain	3.33dBi	3.29dBi	1.73dBi
Average gain	-2.33dBi	-2.35dBi	-3.33dBi
Average efficiency	>57%	>57%	>46%
Maximum return loss	<-7.80dB	<-7.60dB	<-10.10dB
Maximum VSWR	2.30:1	2.40:1	1.90:1

	2300 – 2400 MHz		
	Fixed (IP67)	Hinged	Fly Lead (1.0m)
Peak gain	3.29dBi	3.23dBi	1.51dBi
Average gain	-1.81dBi	-2.12dBi	-3.17dBi
Average efficiency	>65%	>60%	>48%
Maximum return loss	<-8.90dB	<-9.40dB	<-14.11dB
Maximum VSWR	2.10:1	2.00:1	1.50:1

	2500 – 2690 MHz		
	Fixed (IP67)	Hinged	Fly Lead (1.0m)
Peak gain	4.14dBi	4.08dBi	1.59dBi
Average gain	-1.84dBi	-2.17dBi	-3.11dBi
Average efficiency	>65%	>60%	>48%
Maximum return loss	<-7.40dB	<-5.50dB	<-10.30dB
Maximum VSWR	2.50:1	3.20:1	1.90:1

7. RF Performance

7.1 Return Loss

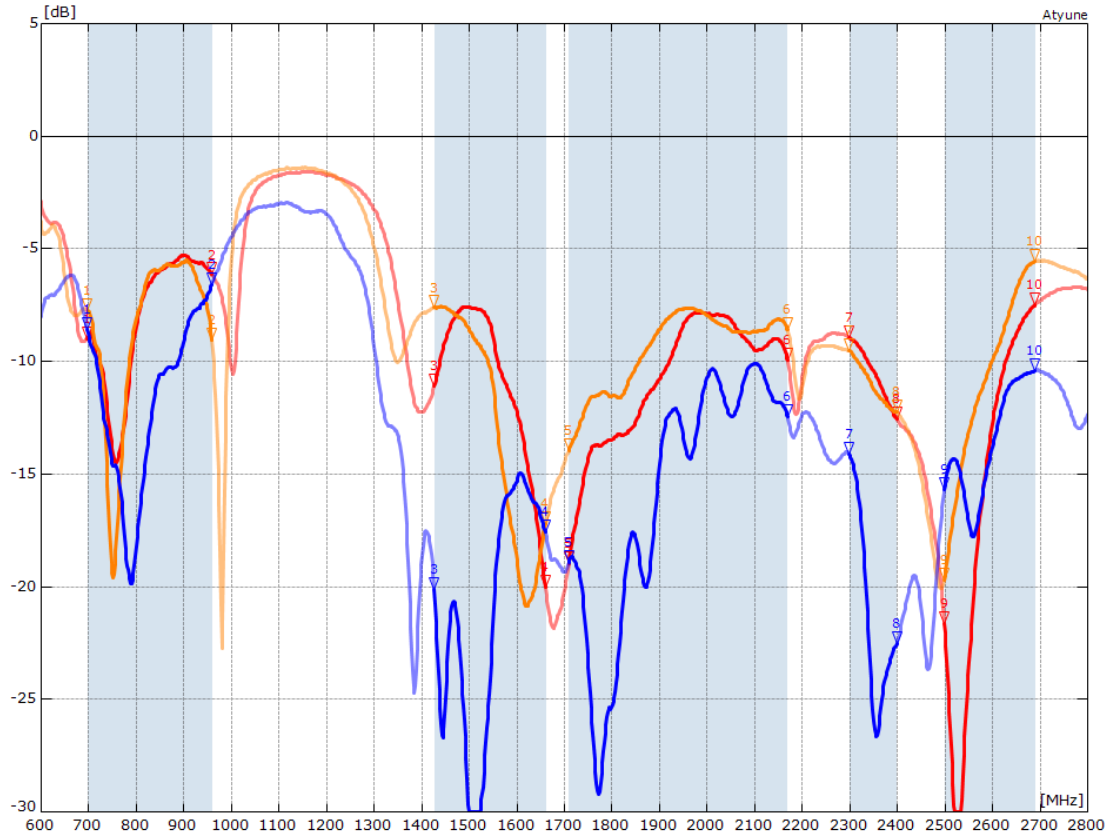

MARKERS: MHz dB MHz dB MHz dB MHz dB MHz dB									
Fixed.S1P - S11									
1: 698	-8.96	3: 1427	-11.07	5: 1710	-18.97	7: 2300	-8.91	9: 2500	-21.64
2: 960	-6.13	4: 1661	-19.98	6: 2170	-9.91	8: 2400	-12.54	10: 2690	-7.47
Hinged.S1P - S11									
1: 698	-7.73	3: 1427	-7.59	5: 1710	-13.95	7: 2300	-9.49	9: 2500	-19.66
2: 960	-9.00	4: 1661	-17.19	6: 2170	-8.57	8: 2400	-12.23	10: 2690	-5.55
Flylead.S1P - S11									
1: 698	-8.58	3: 1427	-20.09	5: 1710	-18.88	7: 2300	-14.11	9: 2500	-15.68
2: 960	-6.55	4: 1661	-17.55	6: 2170	-12.41	8: 2400	-22.48	10: 2690	-10.38

7.2 VSWR

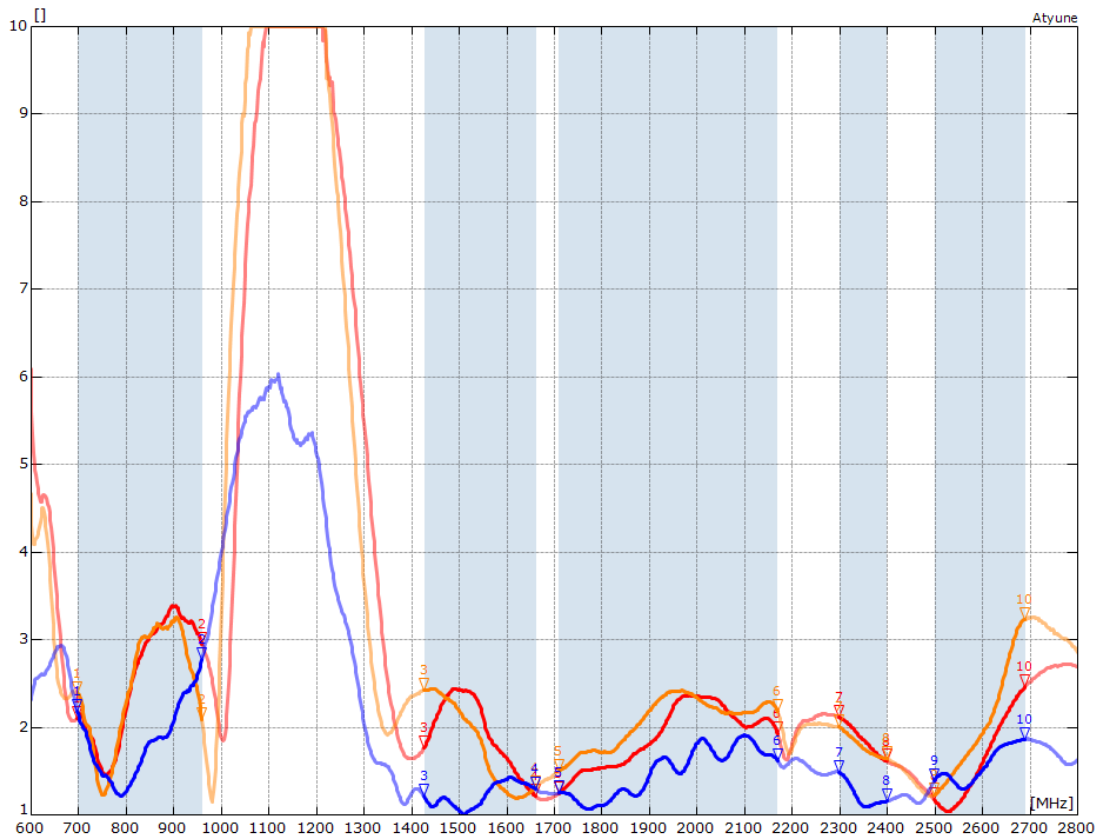

MARKERS:	MHz	MHz	MHz	MHz
Fixed.S1P - S11				
—	1: 698	2.11	3: 1427	1.78
—	2: 960	2.95	4: 1661	1.22
—	5: 1710	1.25	7: 2300	2.12
—	6: 2170	1.94	8: 2400	1.62
—	9: 2500	1.18	10: 2690	2.47
Hinged.S1P - S11				
—	1: 698	2.39	3: 1427	2.43
—	2: 960	2.10	4: 1661	1.32
—	5: 1710	1.50	7: 2300	2.01
—	6: 2170	2.19	8: 2400	1.65
—	9: 2500	1.23	10: 2690	3.24
Flylead.S1P - S11				
—	1: 698	2.19	3: 1427	1.22
—	2: 960	2.78	4: 1661	1.31
—	5: 1710	1.26	7: 2300	1.49
—	6: 2170	1.63	8: 2400	1.16
—	9: 2500	1.39	10: 2690	1.87

7.3 Antenna Pattern Free Space

7.3.1 698 MHz – 960 MHz Fixed (IP67)

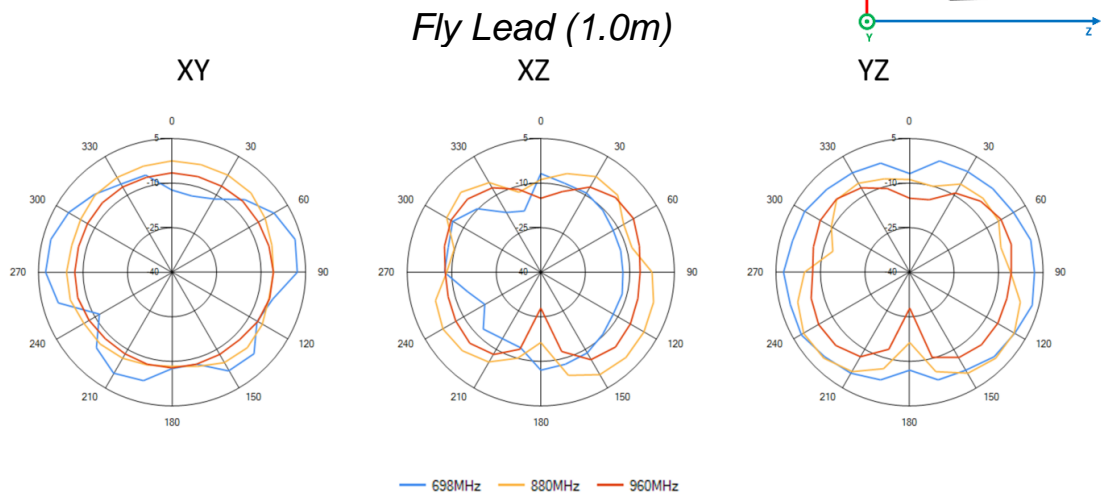
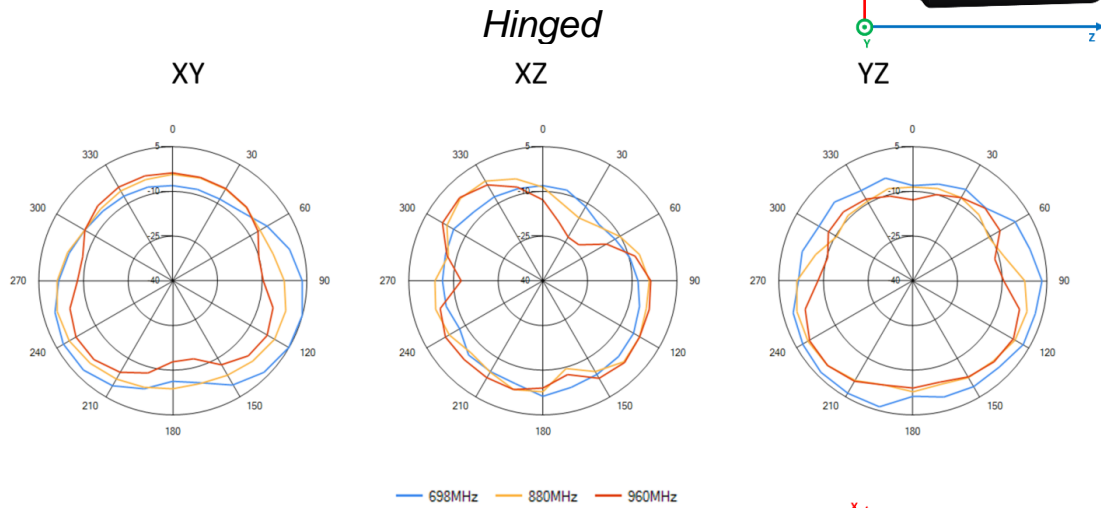
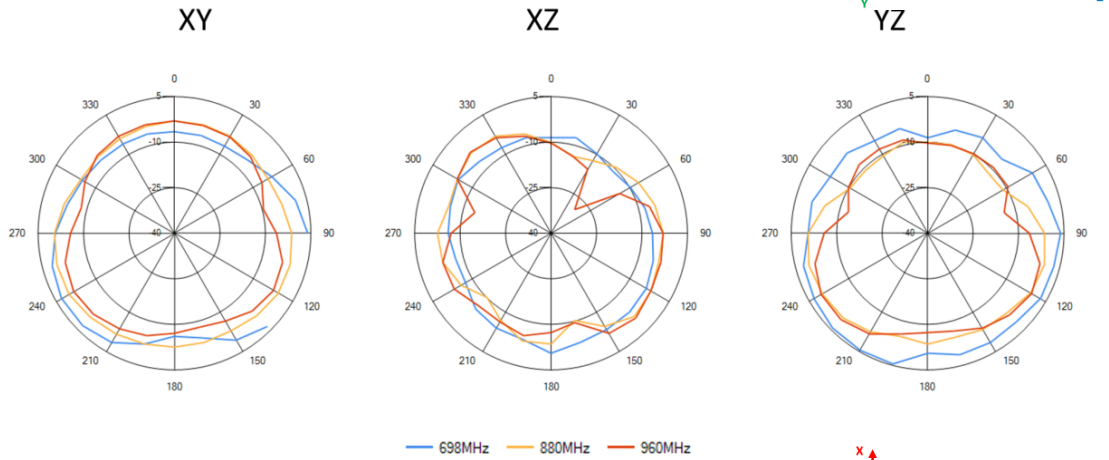

7.3.2 1427 MHz – 1661 MHz Fixed (IP67)

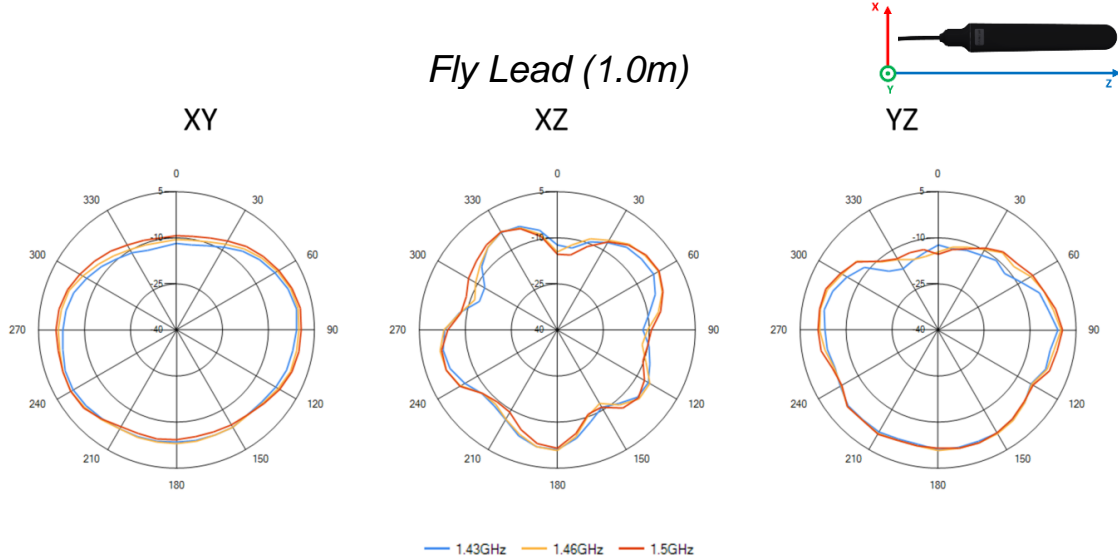
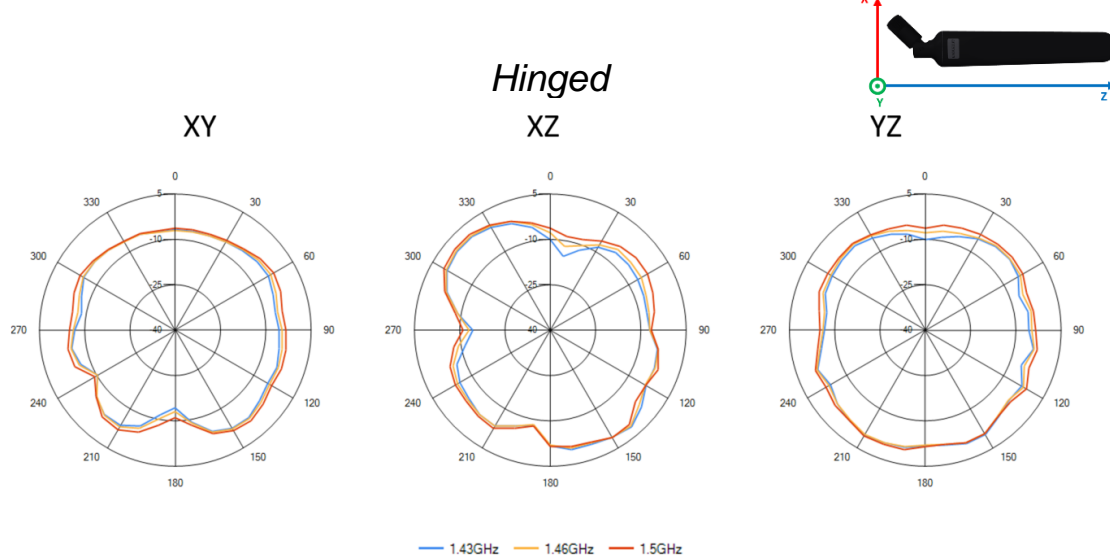
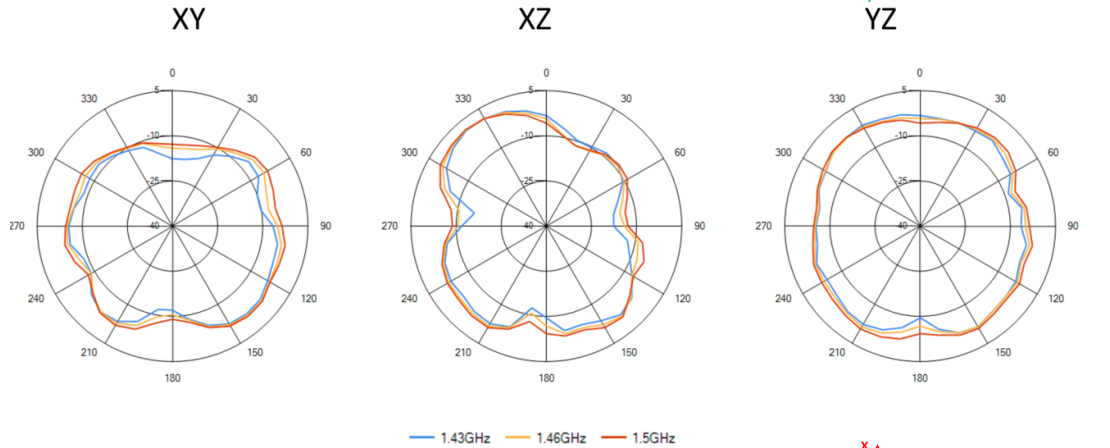

7.3.3 1710 MHz – 2170 MHz

Fixed (IP67)

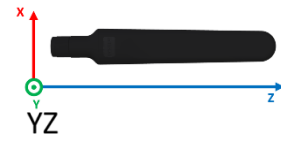

XY

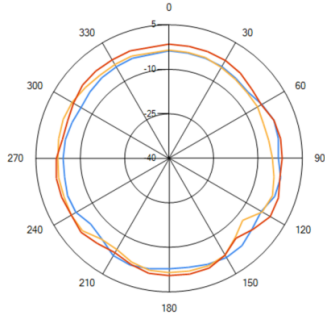

XZ

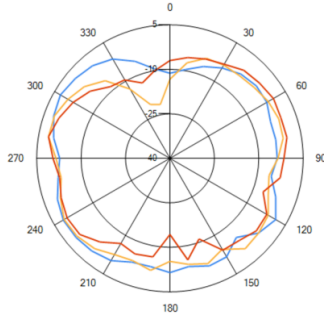

YZ

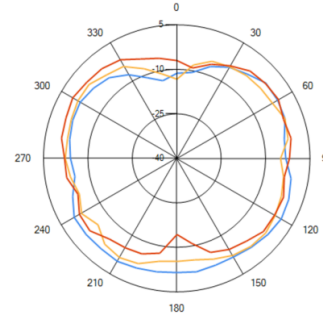

— 1.71GHz — 1.97GHz — 2.17GHz

Hinged

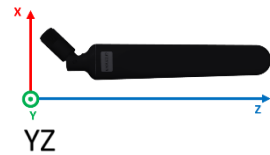

XY

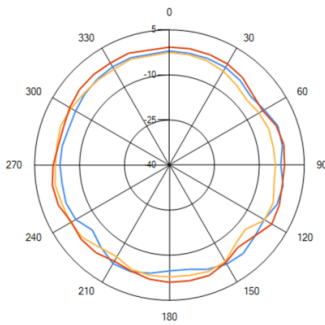

XZ

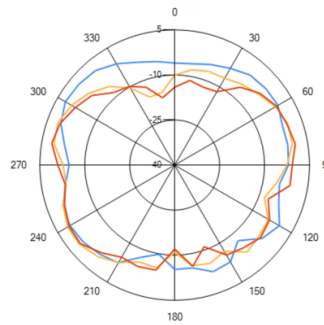

YZ

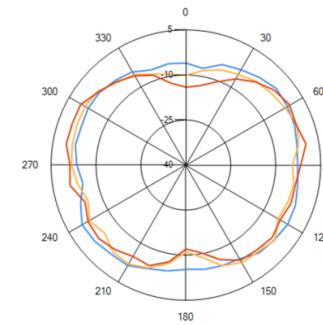

— 1.71GHz — 1.97GHz — 2.17GHz

Fly Lead (1.0m)

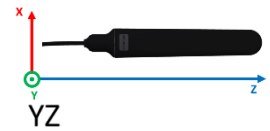

XY

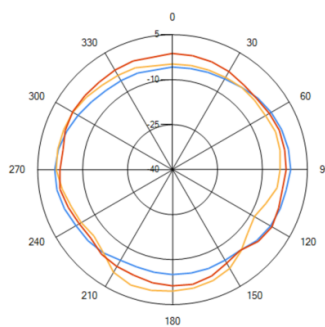

XZ

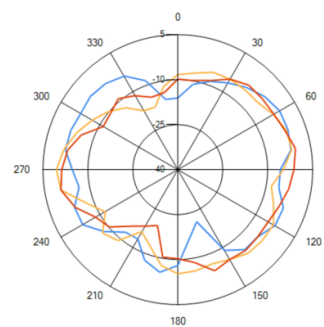

YZ

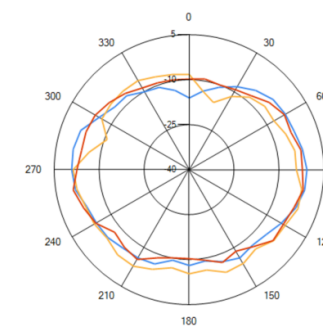

— 1.71GHz — 1.97GHz — 2.17GHz

7.3.4 2300 MHz – 2400 MHz

Fixed (IP67)

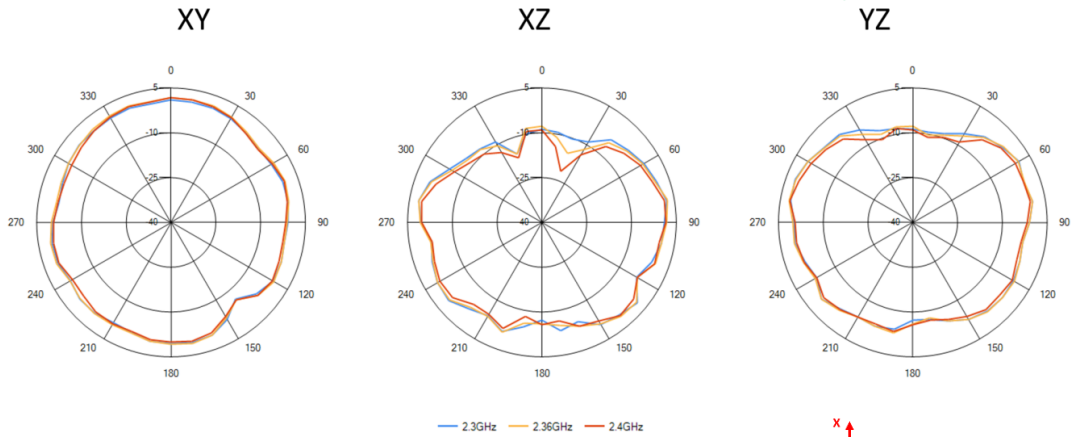

Hinged

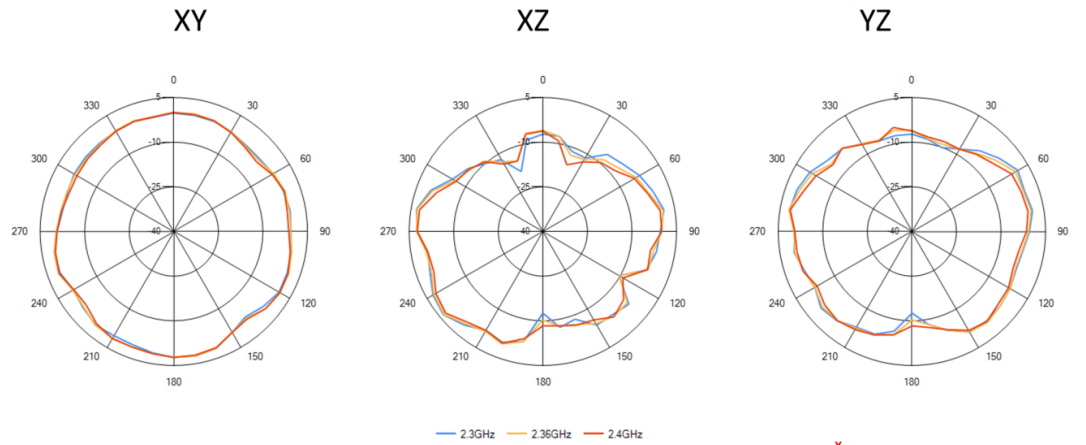
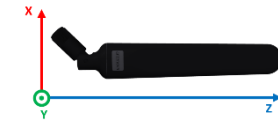

Fly Lead (1.0m)

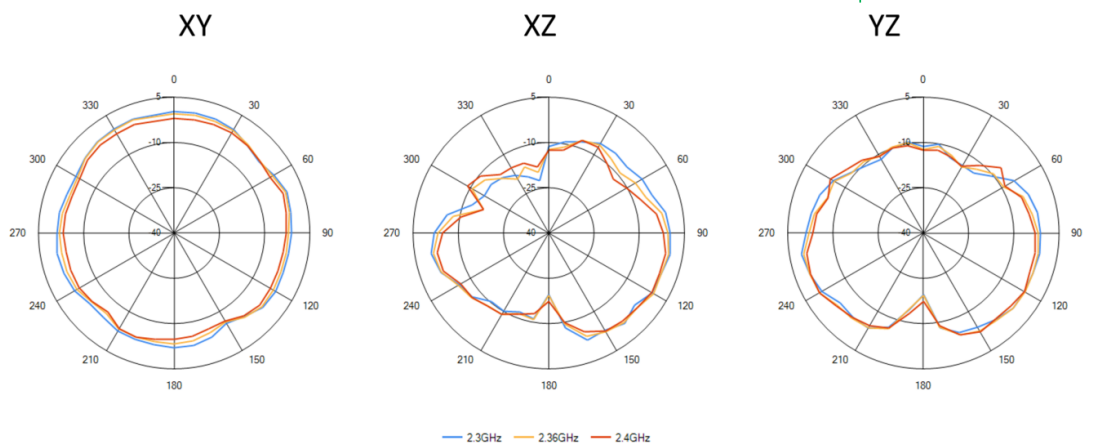
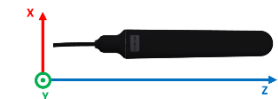

7.3.5 2500 MHz – 2690 MHz

Fixed (IP67)



XY

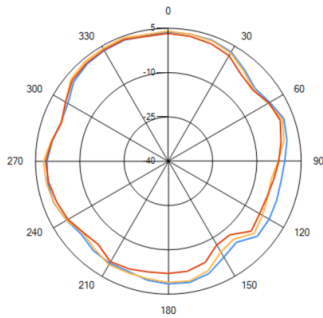

XZ

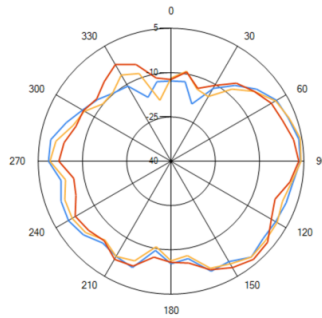

YZ

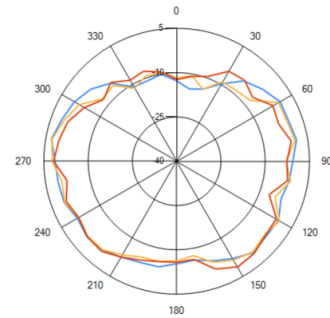

— 2.5GHz — 2.6GHz — 2.69GHz

Hinged



XY

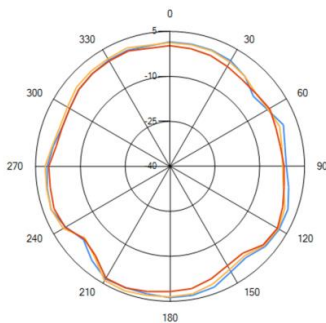

XZ

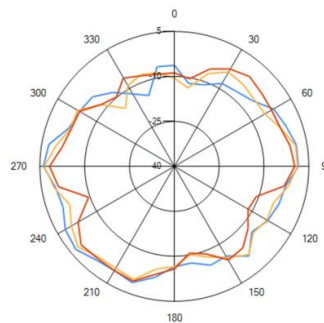

YZ

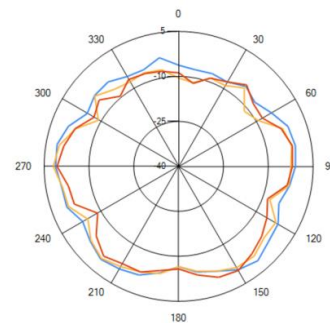

— 2.5GHz — 2.6GHz — 2.69GHz

Fly Lead (1.0m)

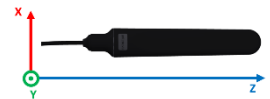

XY

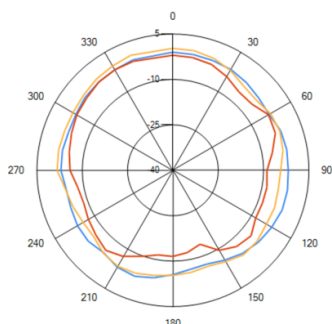

XZ

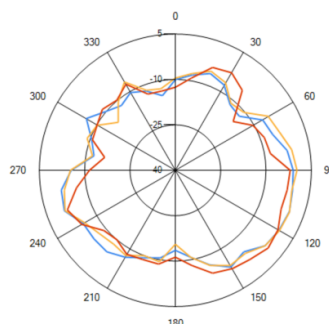

YZ

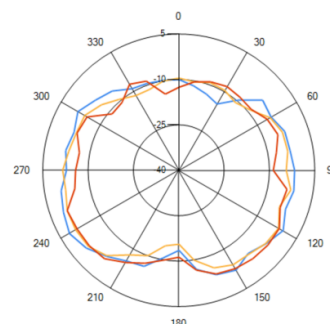

— 2.5GHz — 2.6GHz — 2.69GHz

7.4 Antenna Pattern Free Space (3D)

7.4.1 698 MHz – 960 MHz

3D patterns at 746MHz

*Drag to rotate pattern and PCB by using Adobe Reader
(Click to Activate)*

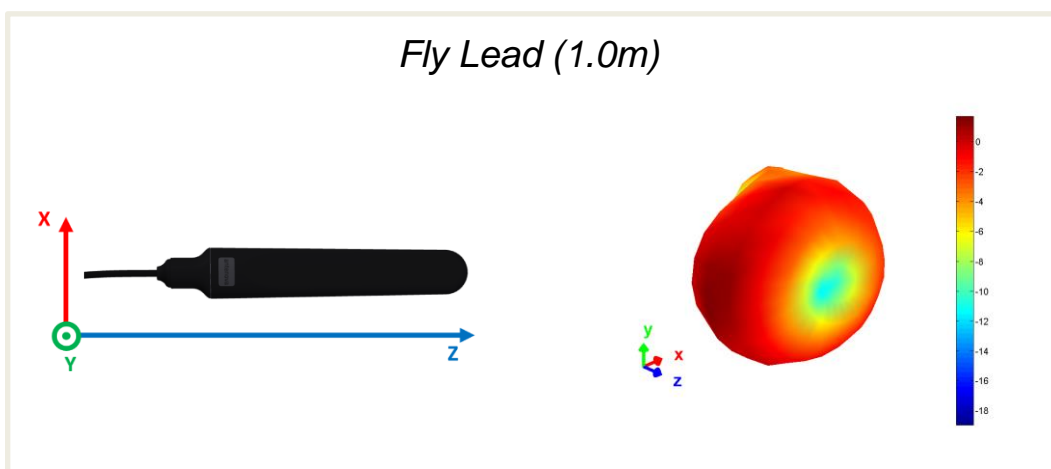
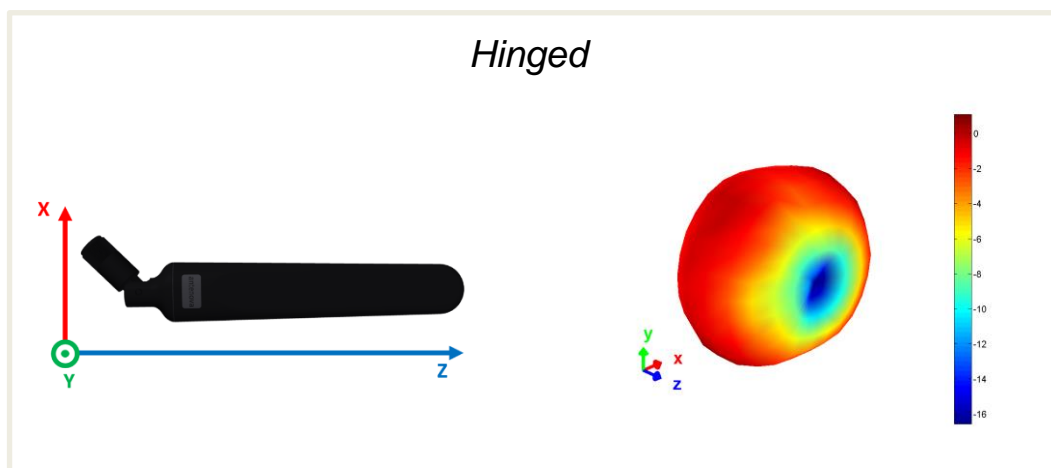
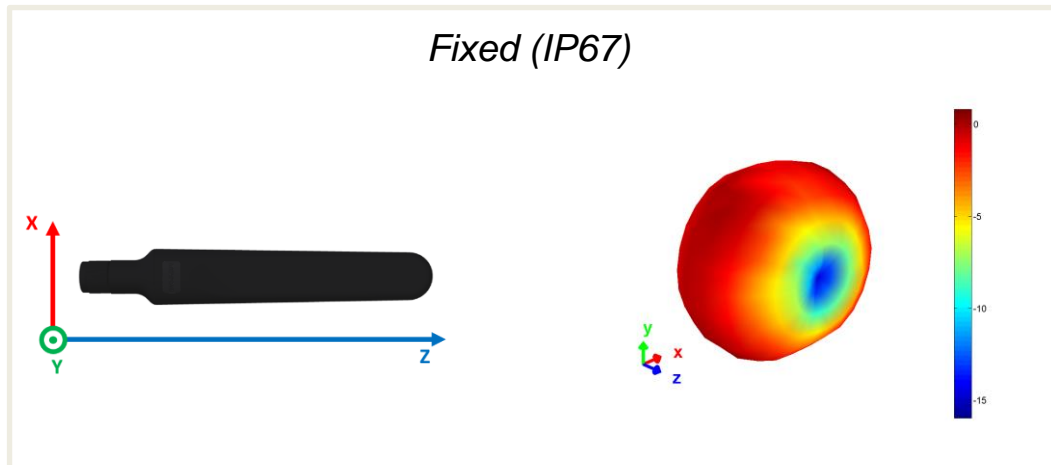

7.4.2 1427 MHz – 1661 MHz 3D patterns at 1500MHz

*Drag to rotate pattern and PCB by using Adobe Reader
(Click to Activate)*

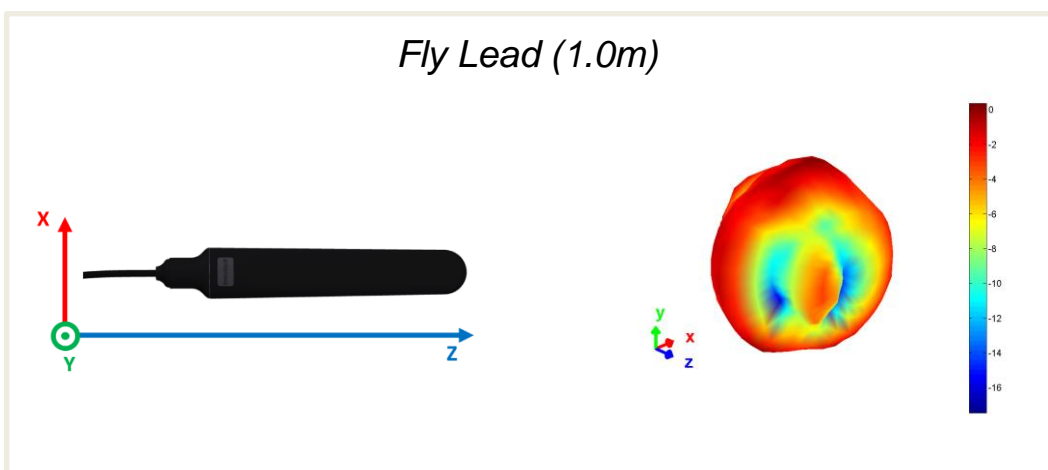
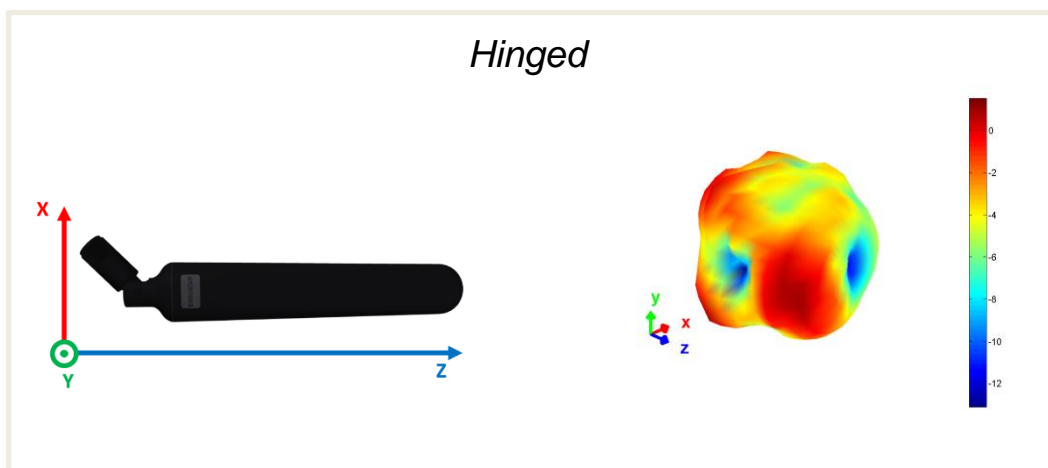
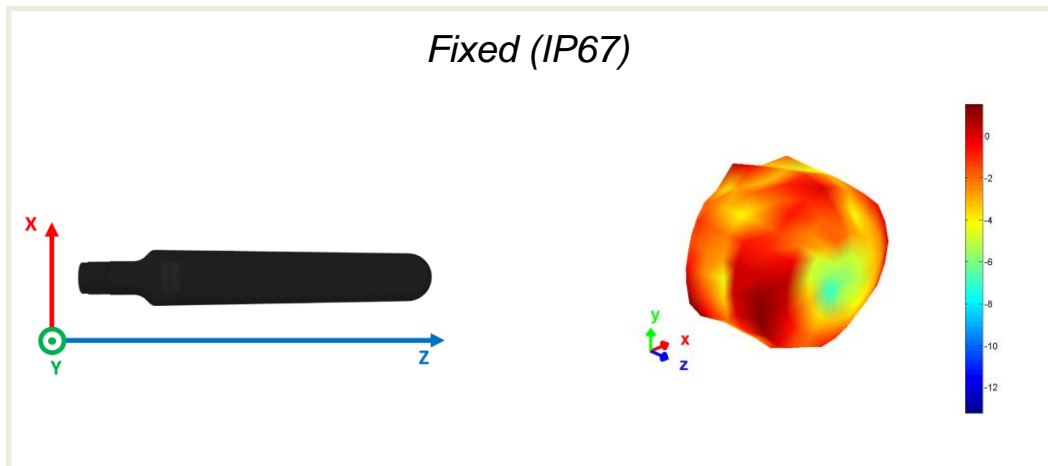

7.4.3 1710 MHz – 2170 MHz 3D patterns at 1930MHz

*Drag to rotate pattern and PCB by using Adobe Reader
(Click to Activate)*

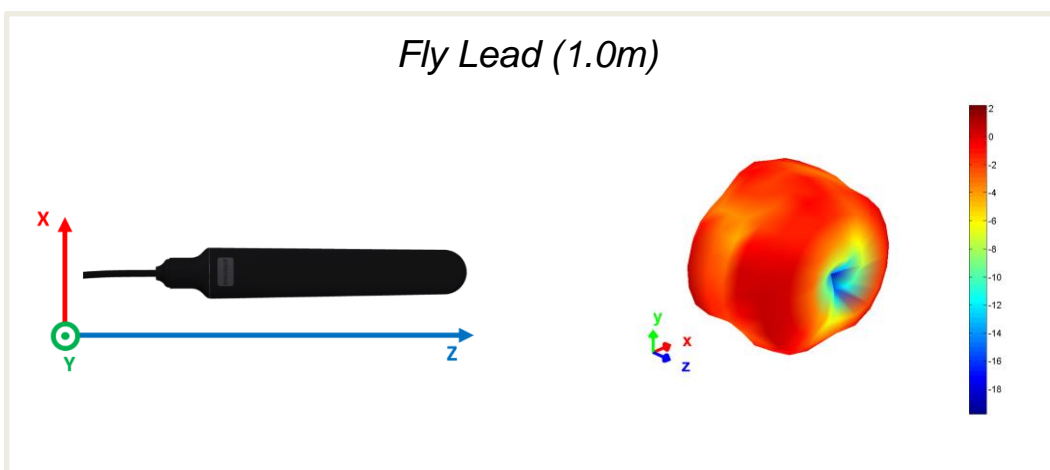
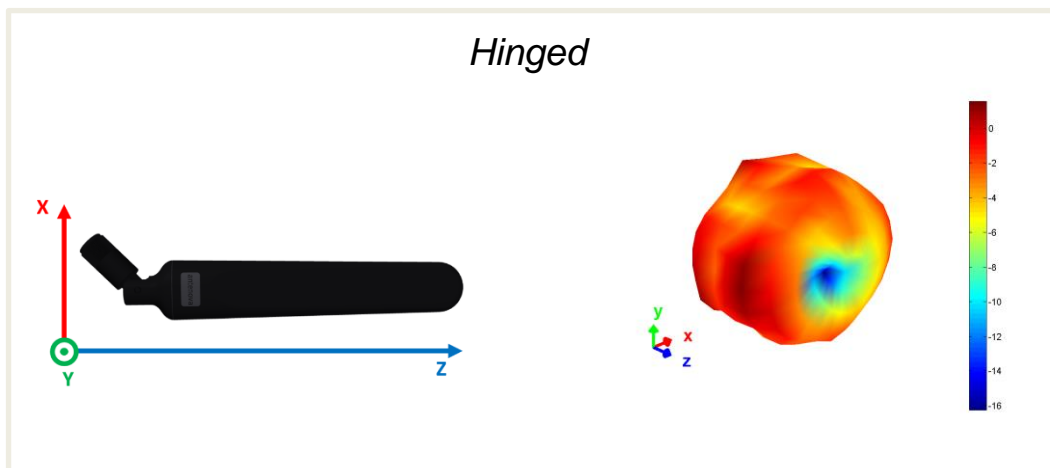
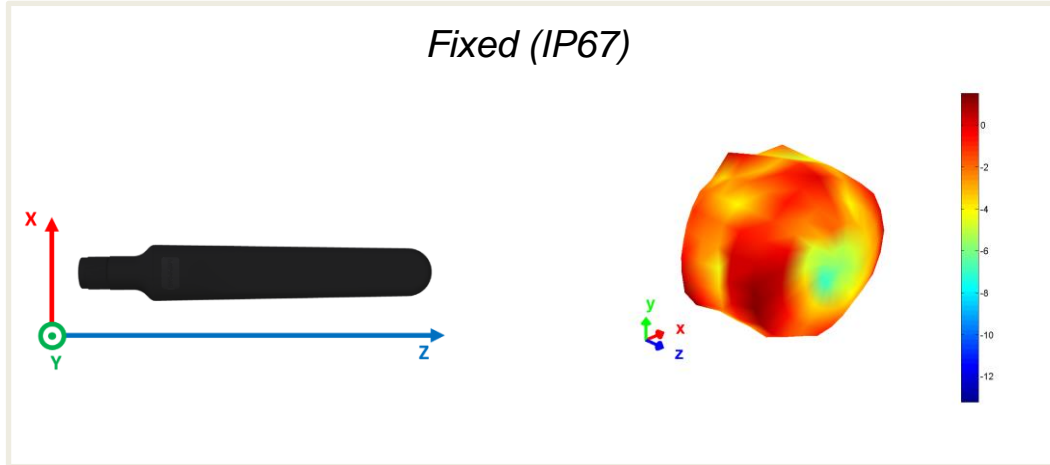

7.4.4 2300 MHz – 2400 MHz 3D patterns at 2350MHz

*Drag to rotate pattern and PCB by using Adobe Reader
(Click to Activate)*

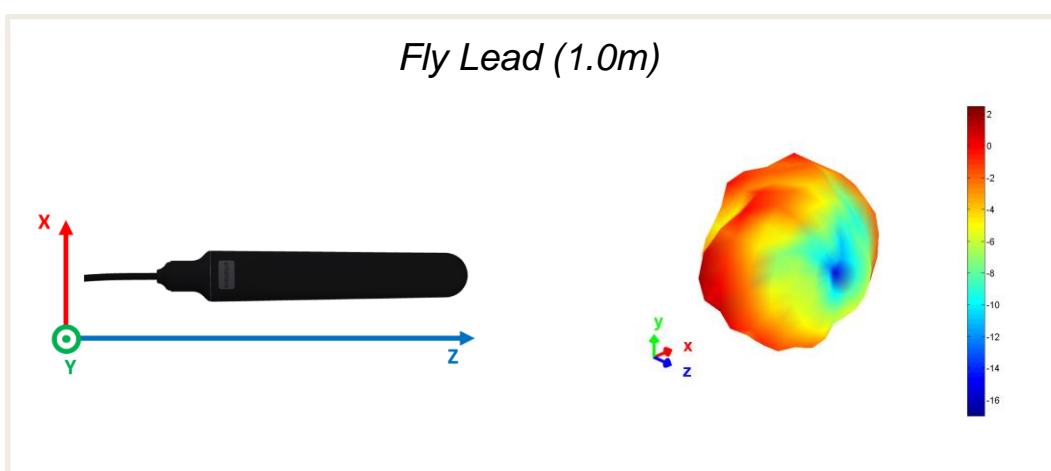
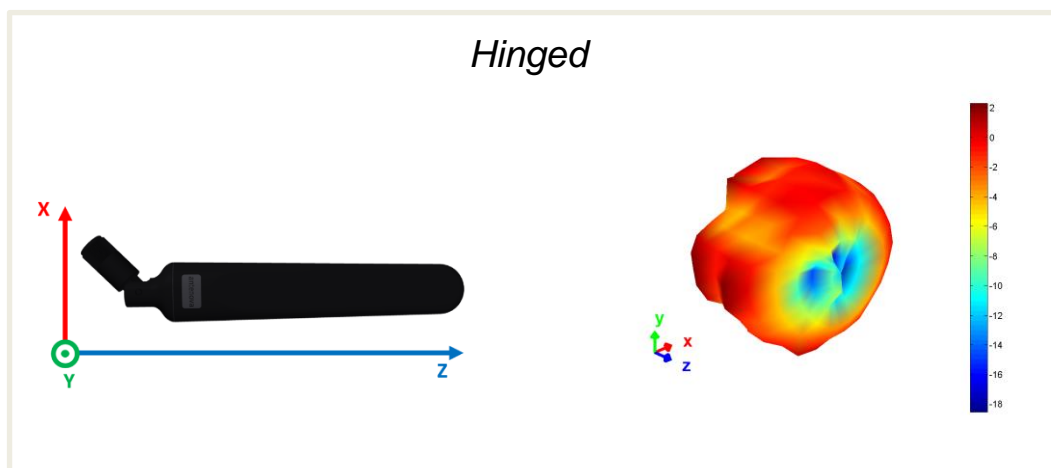
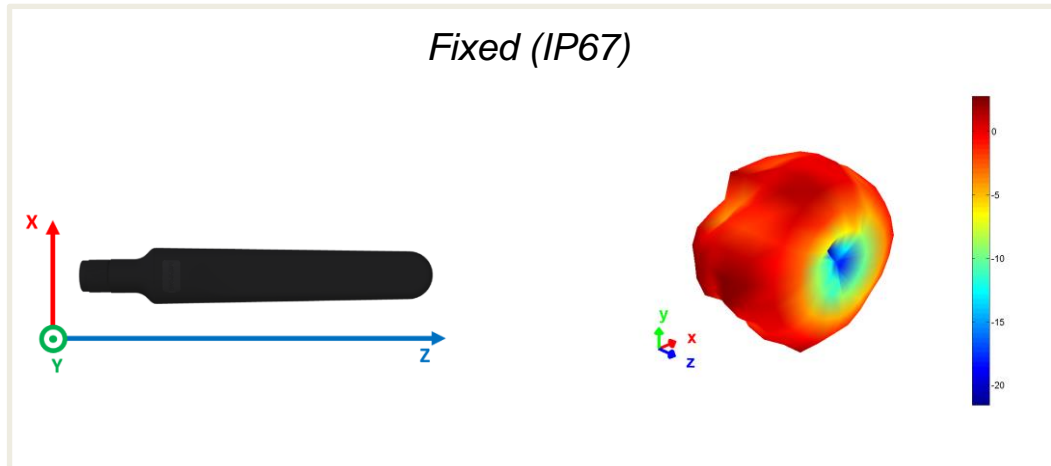

7.4.5 2500 MHz – 2690 MHz 3D patterns at 2600MHz

*Drag to rotate pattern and PCB by using Adobe Reader
(Click to Activate)*

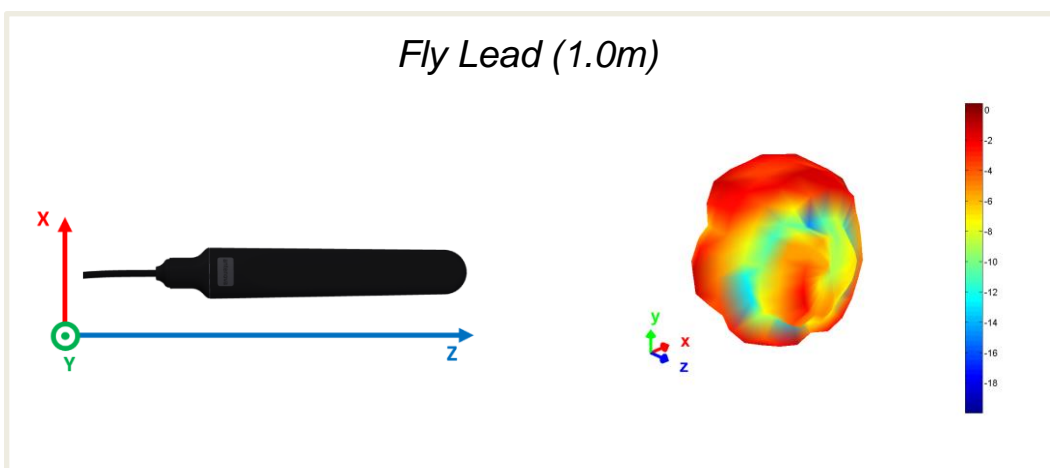
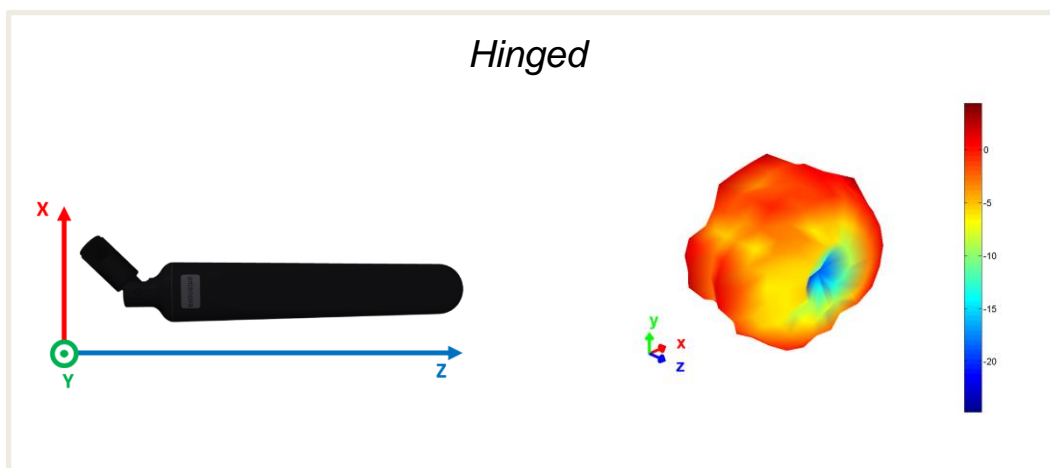
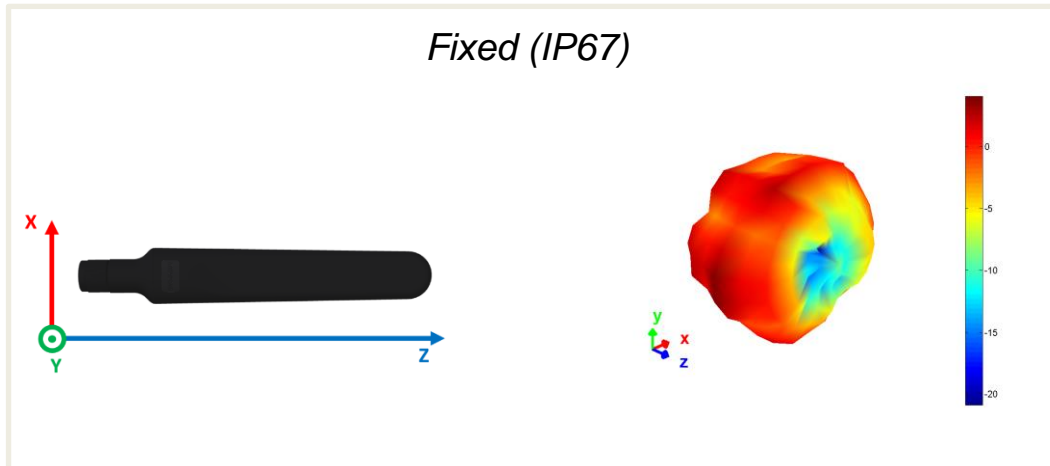

8. Antenna Dimensions

8.1 Dimensions Fixed (SREL036-IPP)

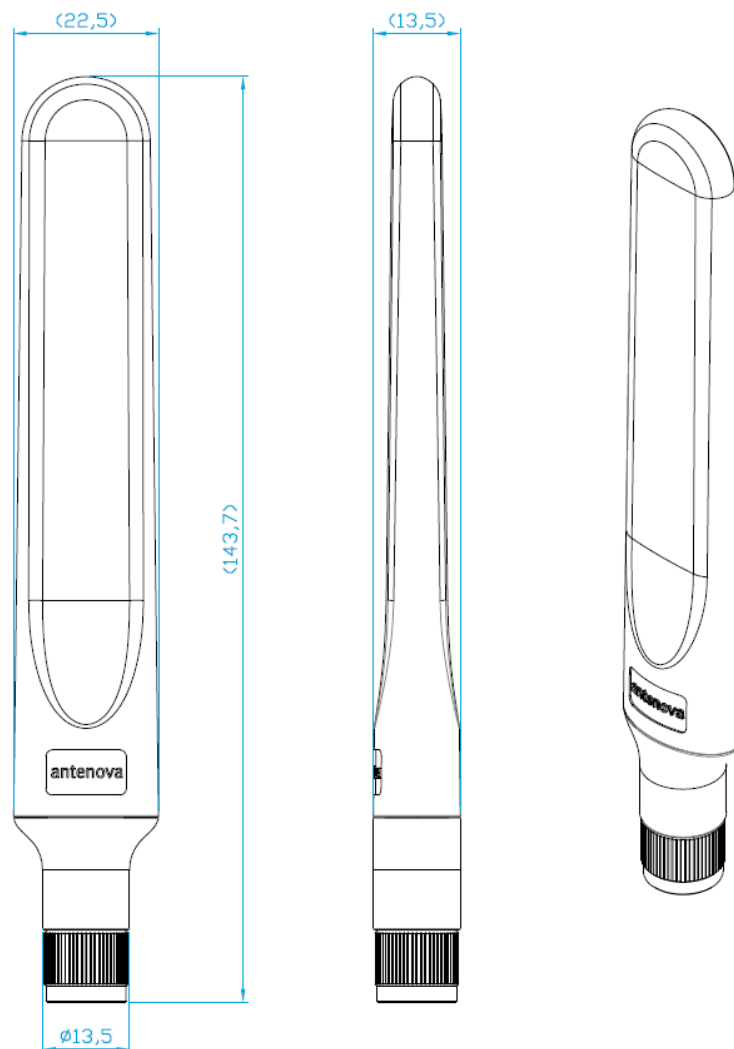

All dimensions in mm

8.1 Dimensions Hinged (SREL036-S9P)

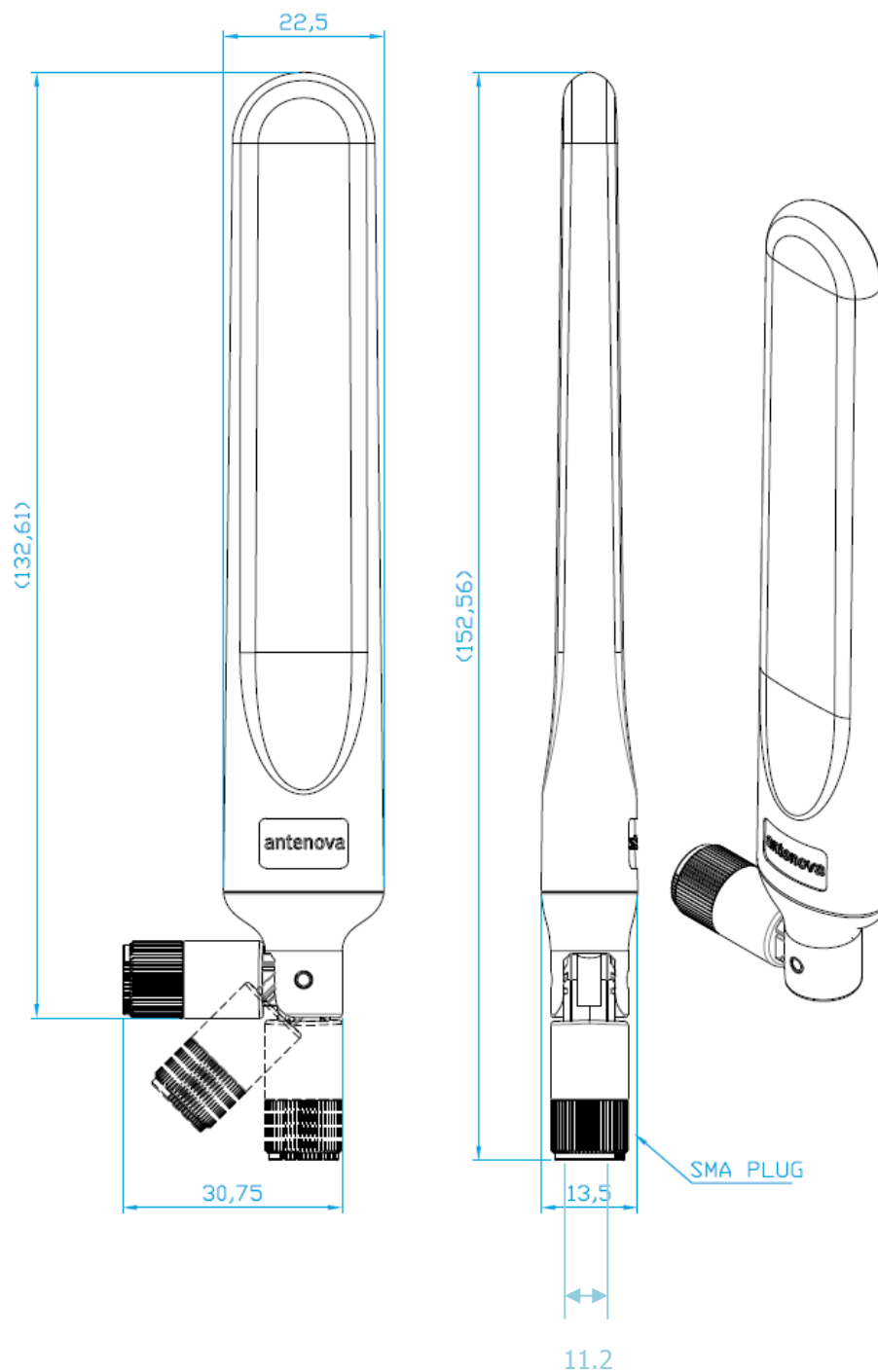

All dimensions in mm

8.1 Dimensions Fly lead (SREL036-10P)

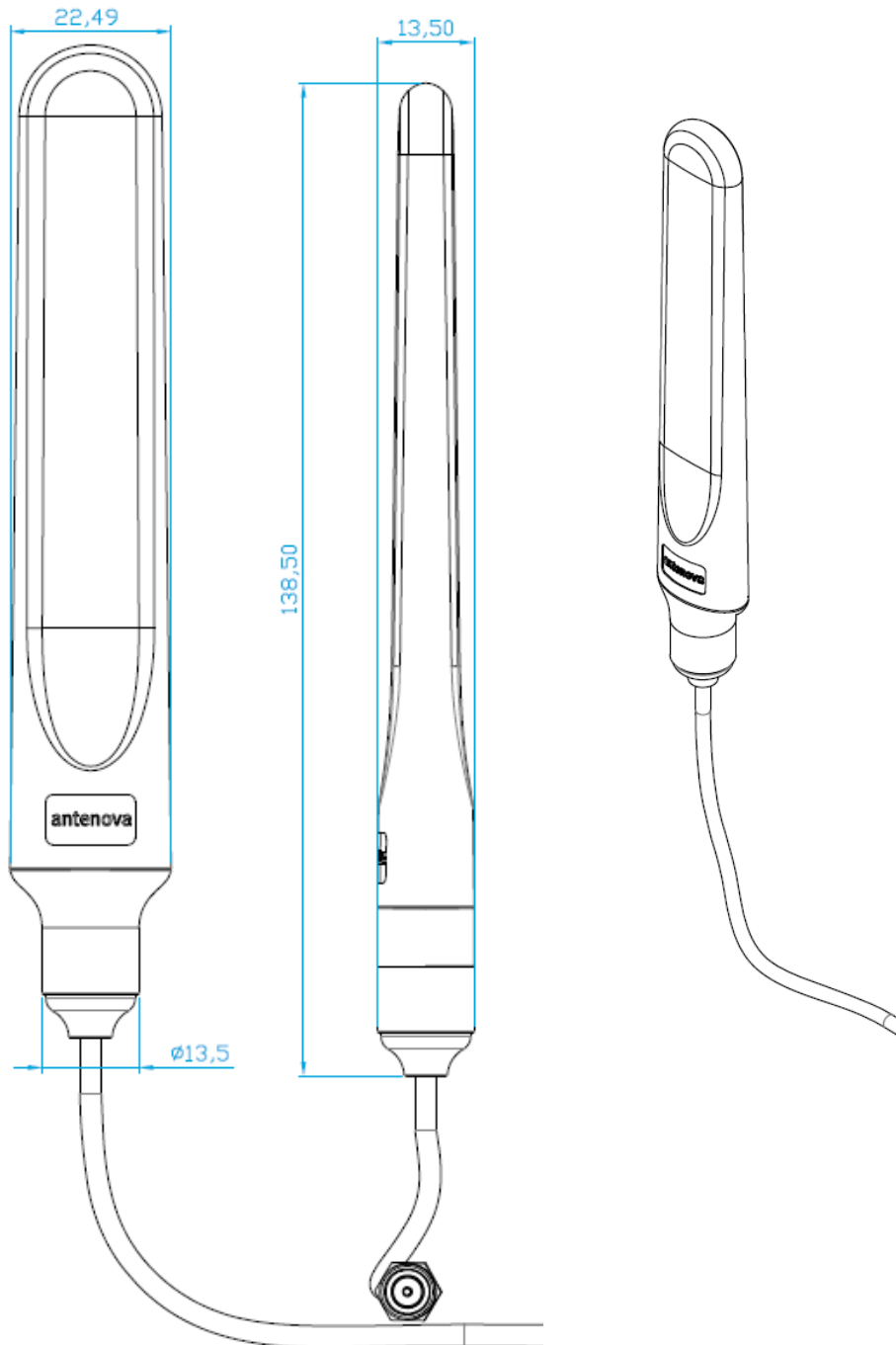

All dimensions in mm

9. Electrical Interface

9.1 Transmission Line

All transmission lines should be designed to have a characteristic impedance of 50Ω.

- The length of the transmission lines should be kept to a minimum
- Any other parts of the RF system like transceivers, power amplifiers, etc, should also be designed to have an impedance of 50 Ω

Once the material for the PCB has been chosen, (PCB thickness and dielectric constant) a coplanar transmission line can easily be designed using any of the commercial software packages for transmission line design. For the chosen PCB thickness, copper thickness and substrate dielectric constant, the program will calculate the appropriate transmission line width and gaps on either side of the feed.

A DC blocking capacitor should be placed in line to protect the RF front end.

10. Hazardous Material Regulation Conformance

The antenna has been tested to conform to RoHS requirements. A certificate of conformance is available from Antenova's website.

11. Packaging

11.1 Fixed (SREL036-IPP)

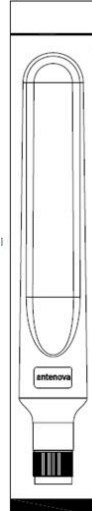

The antennas are supplied in individual polythene bags. Twenty five small bags are packed in one larger bag. The outer box contains fifty antennas.

Box label

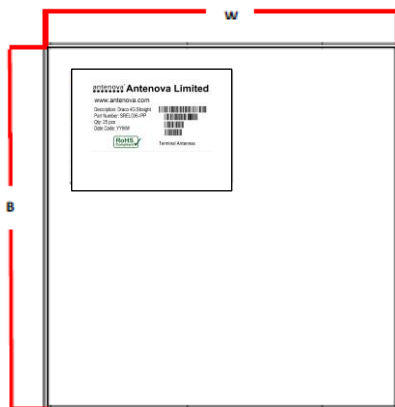

Width W	Breadth B	Thickness H
355 mm	340 mm	58 mm

11.2 Hinged (SREL036-S9P)

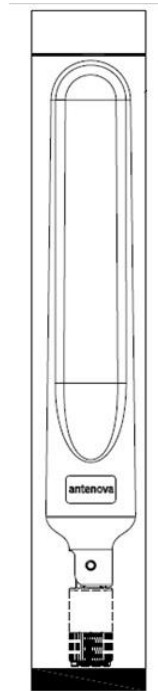

The antennas are supplied in individual polythene bags. Twenty five small bags are packed in one larger bag. The outer box contains fifty antennas.

Box label

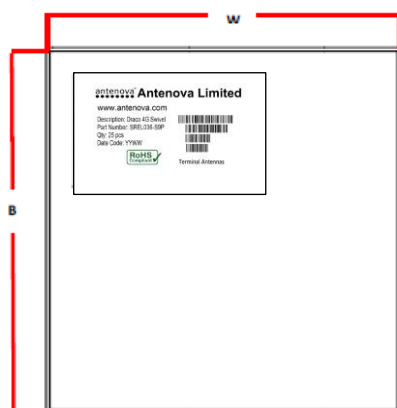

Width W	Breadth B	Thickness H
355 mm	340 mm	58 mm

11.3 Fly lead (SREL036-10P)

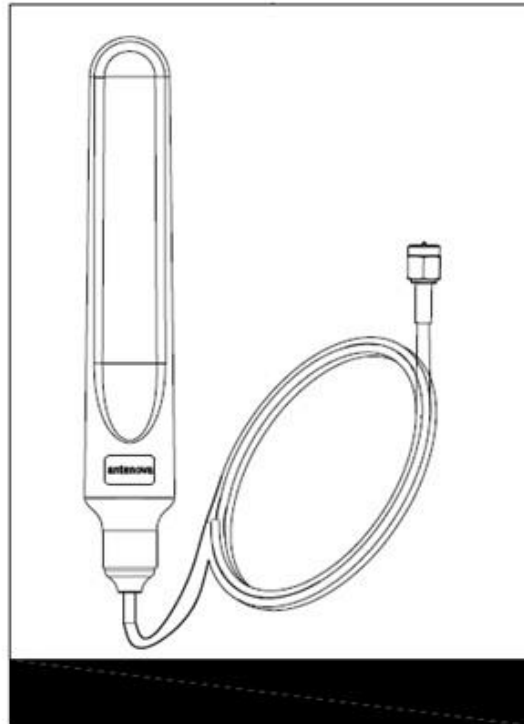

The antennas are supplied in individual polythene bags. Twenty five small bags are packed in one larger bag. The outer box contains fifty antennas.

Box label

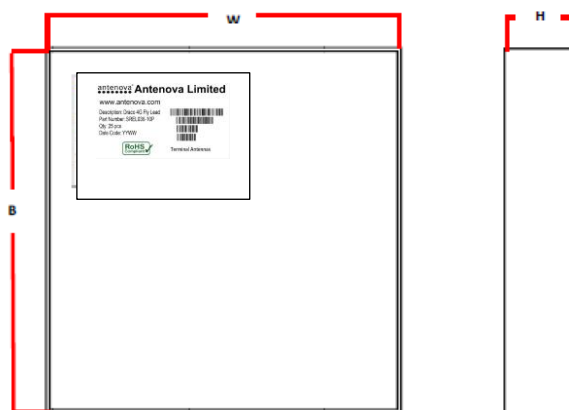

Width W	Breadth B	Thickness H
355 mm	340 mm	58 mm

12. Optimal Storage Conditions

Temperature	-10°C to 40°C
Humidity	Less than 75% RH
Shelf life	18 Months
Storage place	Away from corrosive gas and direct sunlight
Packaging	Antennas should be stored in unopened sealed manufacturer's plastic packaging.

13. Label Information

antennova® Antenova Limited
www.antenova.com
Description: Draco 4G Fly Lead
Part Number: SREL036-10P
Qty: 25 pcs
Date Code: YYWW



 Terminal Antennas

antennova® Antenova Limited
www.antenova.com
Description: Draco 4G Fly Lead
Part Number: SREL036-15P
Qty: 25 pcs
Date Code: YYWW



 Terminal Antennas

antennova® Antenova Limited
www.antenova.com
Description: Draco 4G Fly Lead
Part Number: SREL036-17P
Qty: 25 pcs
Date Code: YYWW



 Terminal Antennas

antennova® Antenova Limited
www.antenova.com
Description: Draco 4G Straight
Part Number: SREL036-IPP
Qty: 25 pcs
Date Code: YYWW



 Terminal Antennas

antennova® Antenova Limited
www.antenova.com
Description: Draco 4G Swivel
Part Number: SREL036-S9P
Qty: 25 pcs
Date Code: YYWW



 Terminal Antennas