

## 1. Features

- Terminal antenna for 5G/4G/3G/2G applications
- LTE, HSPA+, WCDMA, CDMA, GSM, GPRS, DCS1800, PCS1900
- LTE bands: 1-21; 23-30; 33-41, 71
- 617-960MHz, 1427-1660MHz, 1710-2170MHz, 2300-2400MHz, 2500-2690MHz, 3200-3800MHz
- High performance dipole design
- Available in two terminal options: swivel and fixed 90° (IP67)

## 2. Description

Rabo is constructed with an ergonomic blade design to blend well to the outside of a device. Two versions are available, an IP67 design for outdoor applications and a hinged swivel mounted version. The antenna is designed to work with various GND plane sizes or in free space for ease of integration.

## 3. Applications

- Routers
- Industrial devices
- Remote devices
- ISM

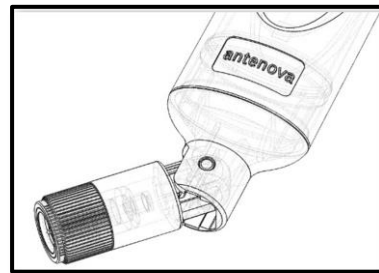

## 4. Part Number

Note. -xxx refers to options for antenna version, connector type and cable length:

Rabo: SREL062-**xxx**

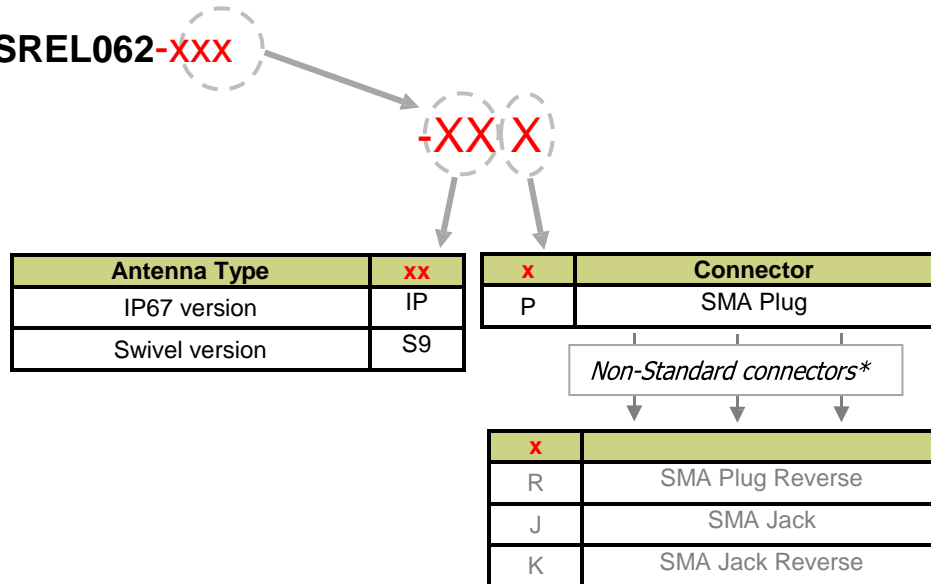



*\*Please contact Antenova for details on non-standard connector types*



## 5. General Data



Product name	Rabo
Part Number	SREL062-xxx
Frequency	617-960 MHz 1420-1660MHz 1710-2170MHz 2300-2400MHz 2500-2690MHz 3200-3800MHz
Polarization	Linear
Operating temperature	-20°C to +70°C
Impedance with matching	50 Ω
Weight	< 21g
Dimensions (Antenna)	See dimensions from page 18>
Connection	SMA Plug (Standard)
Radome Material	PC



## 6. RF Characteristics



The RF characteristics are shown for each type.



	617-960 MHz	
	Fixed (IP67)	Hinged
		
Peak gain	0.69dBi	0.41dBi
Average gain	-3.42dBi	-3.55dBi
Average efficiency	>45%	>45%
Maximum return loss	<-8.77dB	<-5.56dB
Maximum VSWR	2.20:1	2.30:1

	1420-1660 MHz	
	Fixed (IP67)	Hinged
		
Peak gain	2.14dBi	2.42dBi
Average gain	-2.09dBi	-1.88dBi
Average efficiency	>60%	>65%
Maximum return loss	<-9.36dB	<-5.56dB
Maximum VSWR	2.10:1	2.20:1

	1710-2170 MHz	
	Fixed (IP67)	Hinged
		
Peak gain	2.73dBi	2.51dBi
Average gain	-2.27dBi	-2.17dBi
Average efficiency	>60%	>60%
Maximum return loss	<-8.99dB	<-5.56dB
Maximum VSWR	2.15:1	2.20:1

2300-2400 MHz		
	Fixed (IP67)	Hinged
		
Peak gain	4.14dBi	3.87dBi
Average gain	-1.52dBi	-1.43dBi
Average efficiency	>70%	>70%
Maximum return loss	<-17.99dB	<-5.56dB
Maximum VSWR	1.30:1	1.55:1

2500-2690 MHz		
	Fixed (IP67)	Hinged
		
Peak gain	4.89dBi	5.00dBi
Average gain	-0.79dBi	-0.93dBi
Average efficiency	>80%	>80%
Maximum return loss	<-15.61dB	<-5.56dB
Maximum VSWR	1.45:1	1.65:1

3200-3800 MHz		
	Fixed (IP67)	Hinged
		
Peak gain	3.65dBi	3.89dBi
Average gain	-1.26dBi	-1.42dBi
Average efficiency	>75%	>75%
Maximum return loss	<-7.15dB	<-5.56dB
Maximum VSWR	2.60:1	2.10:1

## 7. RF Performance

### 7.1 Return Loss

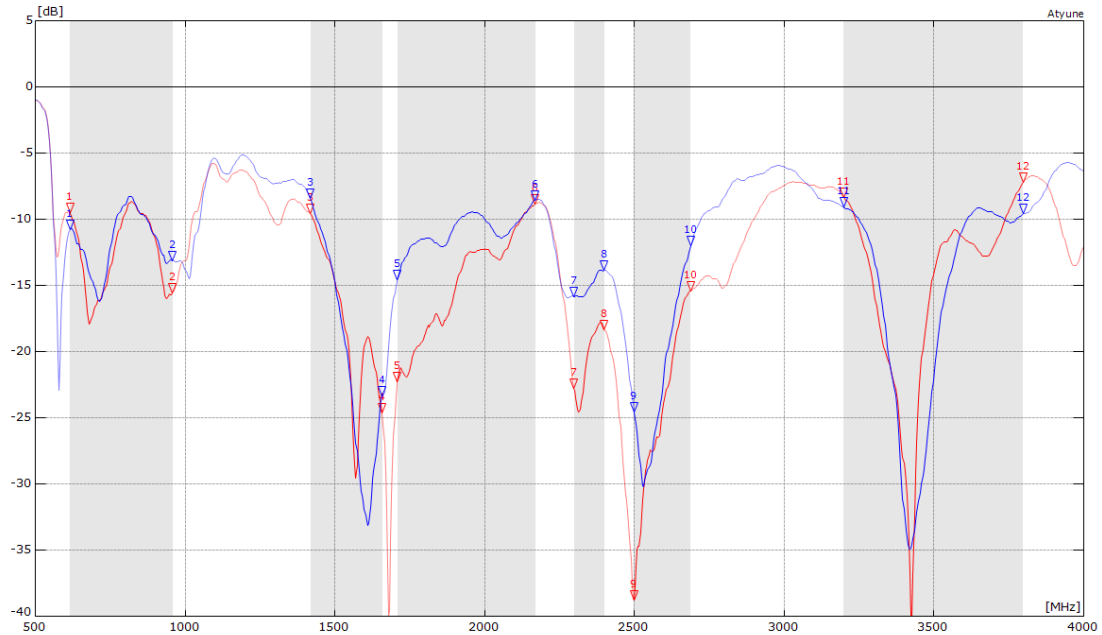

MARKERS:	MHz	dB	MHz	dB	MHz	dB	MHz	dB	MHz	dB	MHz	dB
MIXTA STRAIGHT.S1P - S11												
—	1: 617	-9.46	3: 1420	-9.53	5: 1710	-22.25	7: 2300	-22.75	9: 2500	-36.72	11: 3200	-8.29
—	2: 960	-15.53	4: 1660	-24.61	6: 2170	-8.84	8: 2400	-18.33	10: 2690	-15.36	12: 3800	-7.16
MIXTA SWIVEL.S1P - S11												
—	1: 617	-10.72	3: 1420	-8.41	5: 1710	-14.54	7: 2300	-15.79	9: 2500	-24.51	11: 3200	-9.07
—	2: 960	-13.10	4: 1660	-23.31	6: 2170	-8.52	8: 2400	-13.82	10: 2690	-11.95	12: 3800	-9.56

## 7.2 VSWR

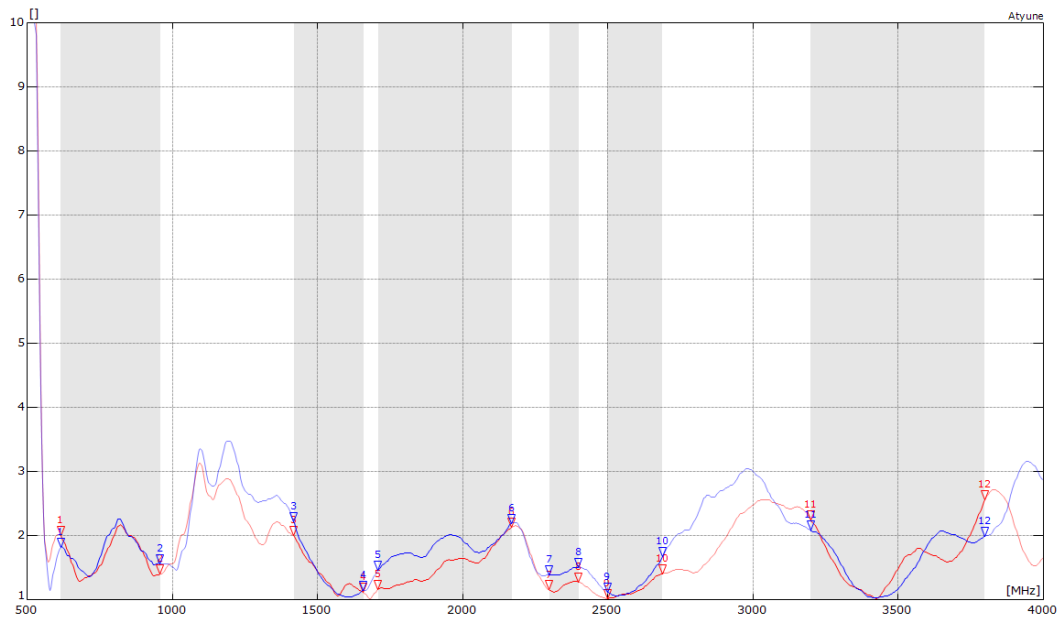

MARKERS:	MHz	MHz	MHz	MHz	MHz							
MIXTA STRAIGHT.S1P - S11												
—	1: 617	2.01	3: 1420	2.00	5: 1710	1.17	7: 2300	1.16	9: 2500	1.02	11: 3200	2.25
—	2: 960	1.40	4: 1660	1.13	6: 2170	2.13	8: 2400	1.28	10: 2690	1.41	12: 3800	2.56
MIXTA SWIVEL.S1P - S11												
—	1: 617	1.82	3: 1420	2.23	5: 1710	1.46	7: 2300	1.39	9: 2500	1.13	11: 3200	2.09
—	2: 960	1.57	4: 1660	1.15	6: 2170	2.20	8: 2400	1.51	10: 2690	1.68	12: 3800	2.00

## 7.3 Antenna Pattern Free Space

### 7.3.1 617 MHz – 960 MHz *Fixed (IP67)*

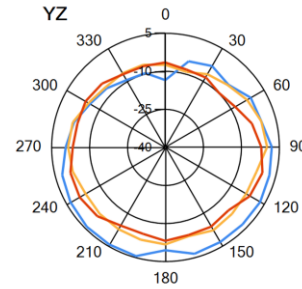
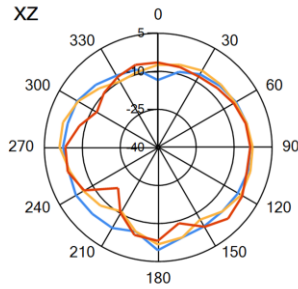
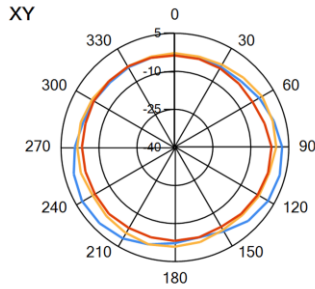

— 617MHz — 784MHz — 960MHz

### *Hinged*

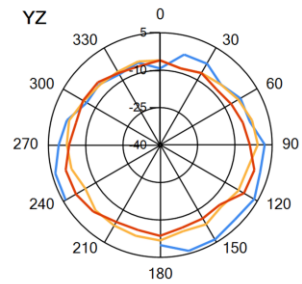
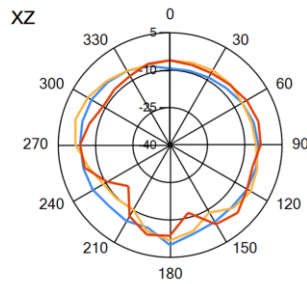
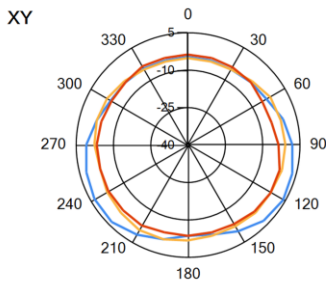

— 617MHz — 784MHz — 960MHz

### 7.3.2 1420 MHz – 1660 MHz Fixed (IP67)

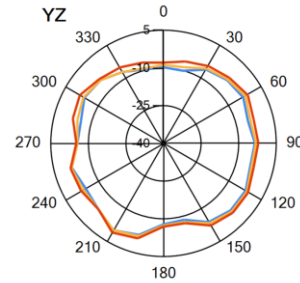
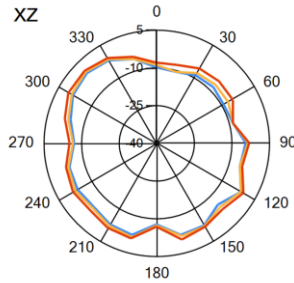
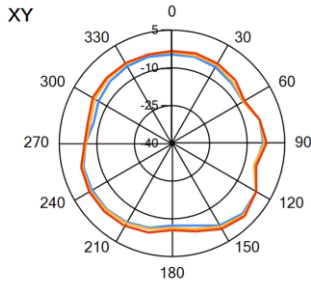

— 1.43GHz — 1.46GHz — 1.5GHz

### Hinged

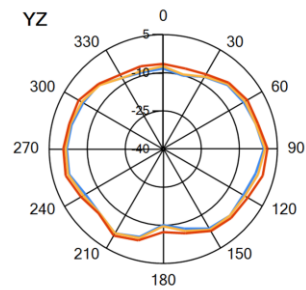
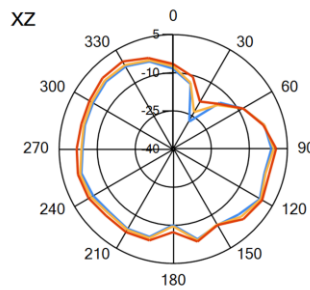
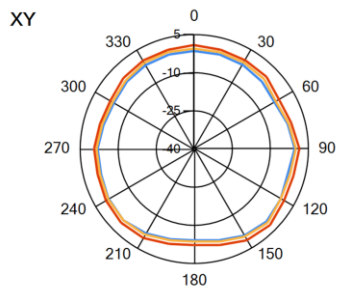

— 1.43GHz — 1.46GHz — 1.5GHz



### 7.3.3 1710 MHz – 2170 MHz

*Fixed (IP67)*

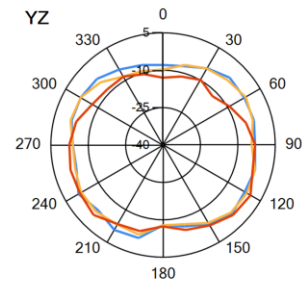
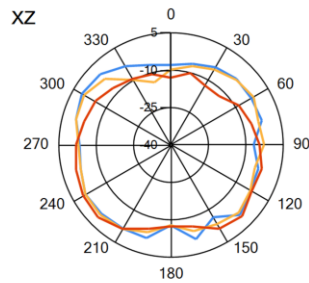
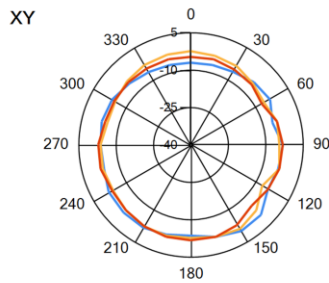

— 1.71GHz — 1.97GHz — 2.17GHz

*Hinged*

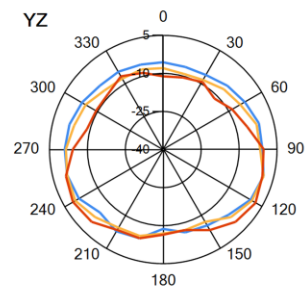
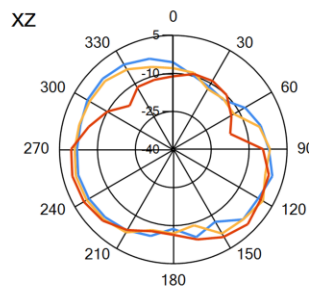
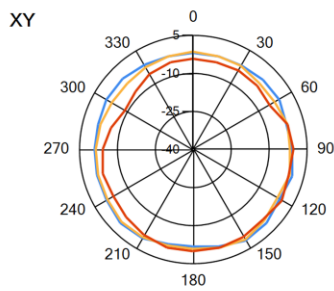

— 1.71GHz — 1.97GHz — 2.17GHz

### 7.3.4 2300 MHz – 2400 MHz

*Fixed (IP67)*

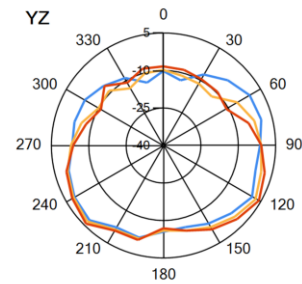
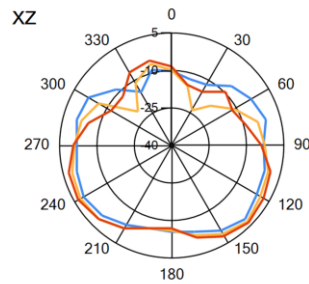
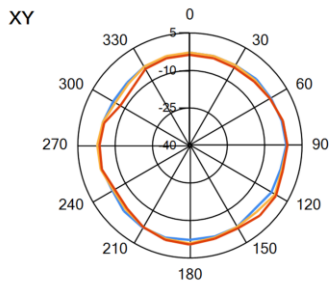

— 2.3GHz — 2.36GHz — 2.4GHz

*Hinged*

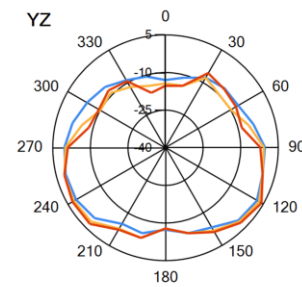
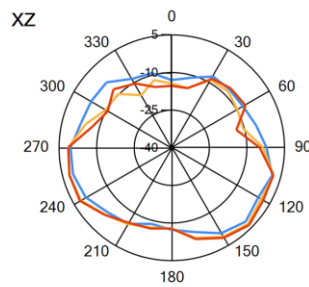
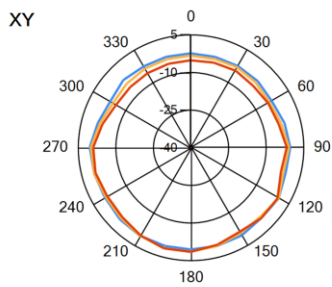

— 2.3GHz — 2.36GHz — 2.4GHz

### 7.3.5 2500 MHz – 2690 MHz

*Fixed (IP67)*

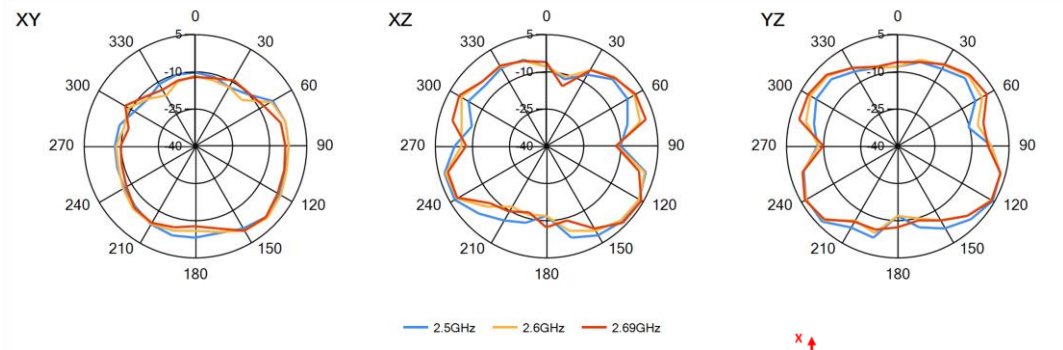

*Hinged*

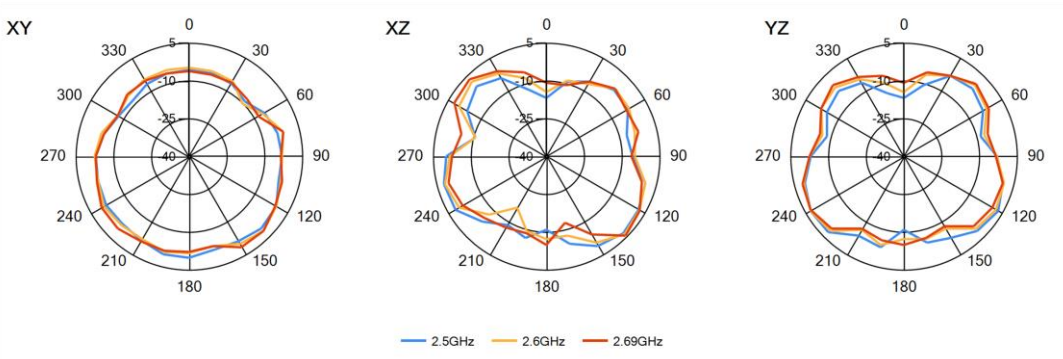

### 7.3.6 3200 MHz – 3800 MHz

*Fixed (IP67)*

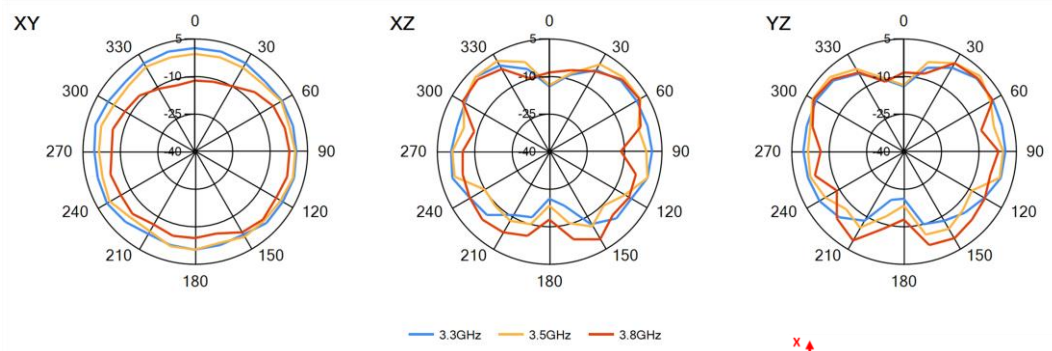

*Hinged*

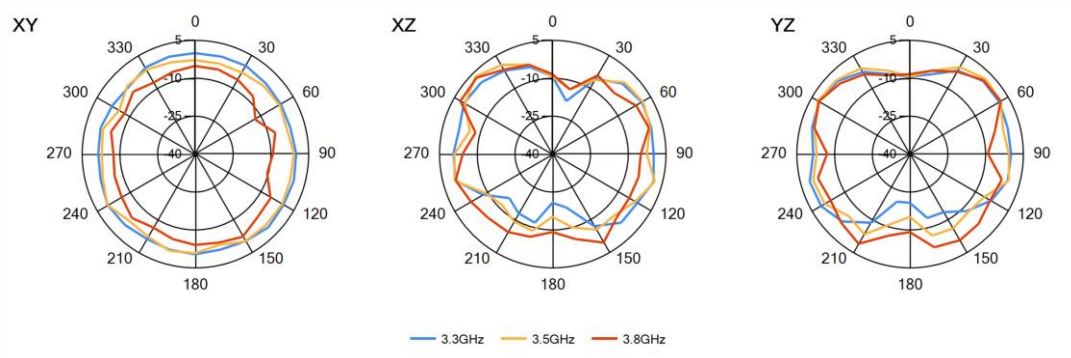

## 7.4 Antenna Pattern Free Space (3D)

### 7.4.1 617 MHz – 960 MHz

#### 3D patterns at 784MHz

*Drag to rotate pattern and PCB by using Adobe Reader  
(Click to Activate)*

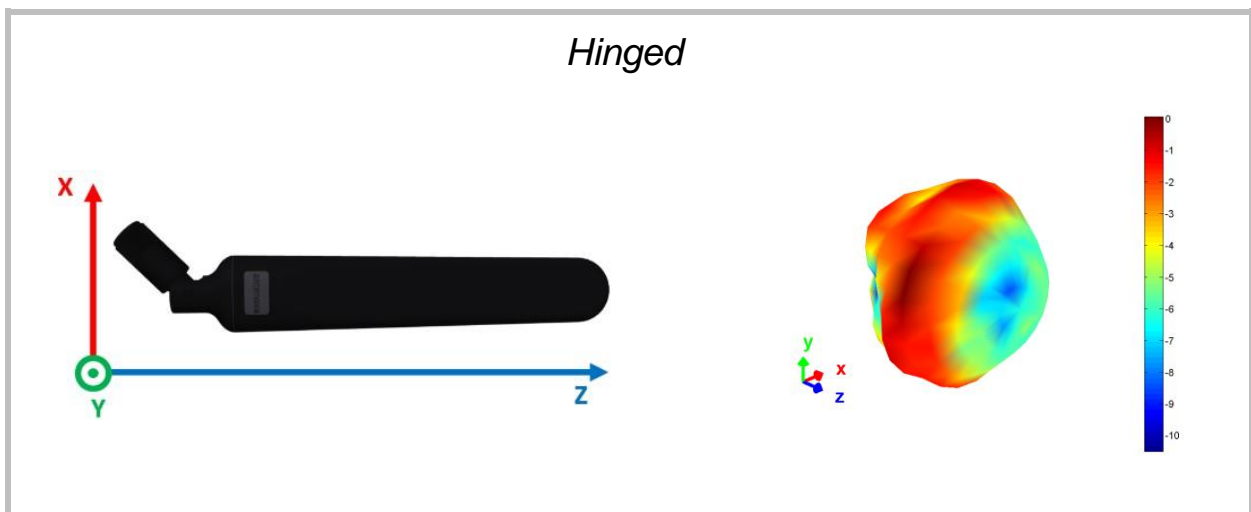
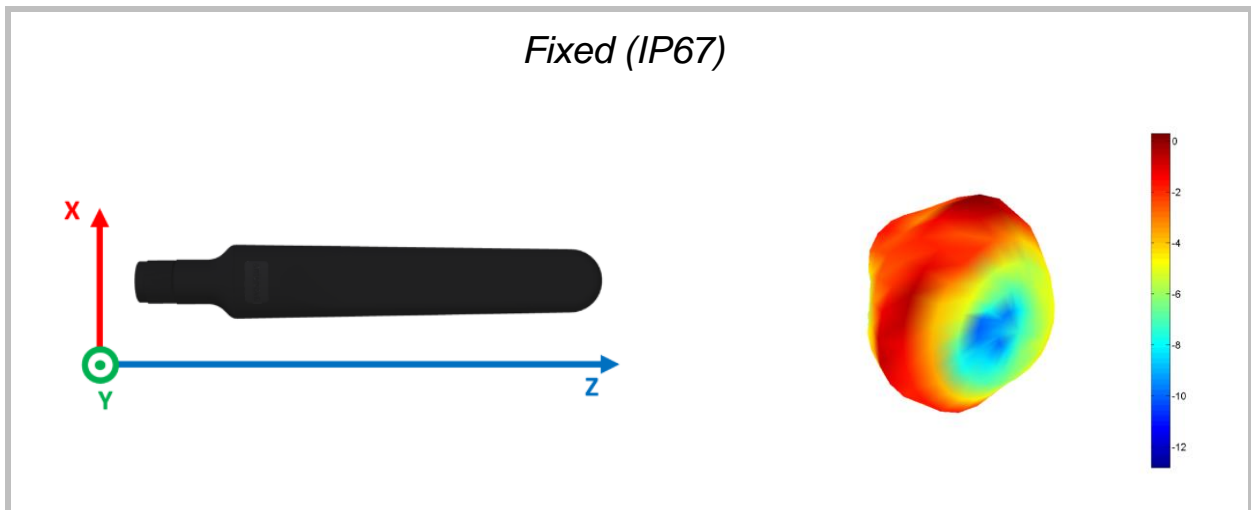

## 7.4.2 1420 MHz – 1660 MHz 3D patterns at 1460MHz

*Drag to rotate pattern and PCB by using Adobe Reader  
(Click to Activate)*

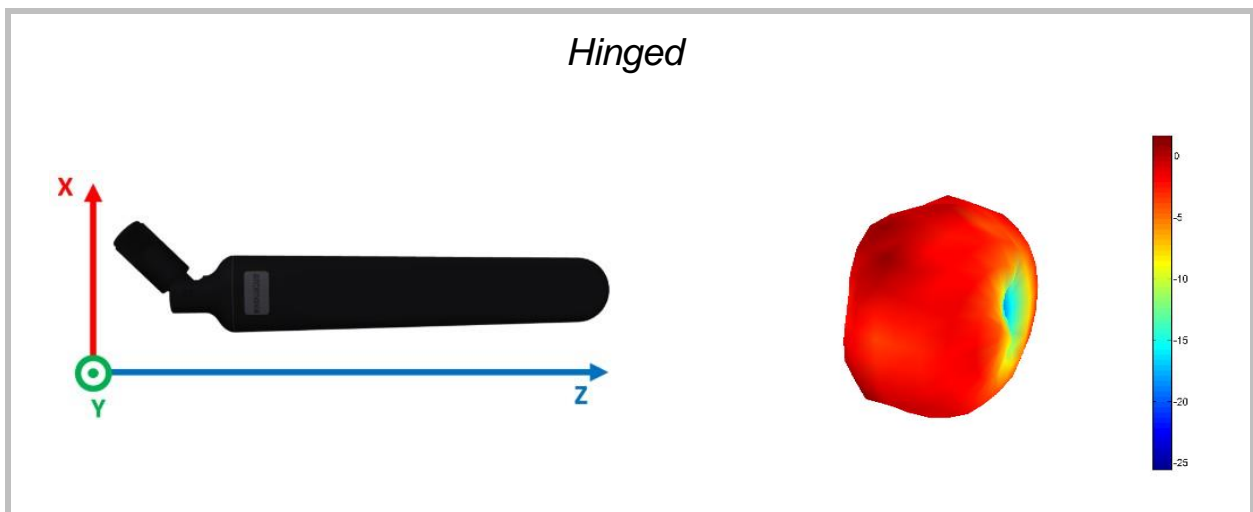
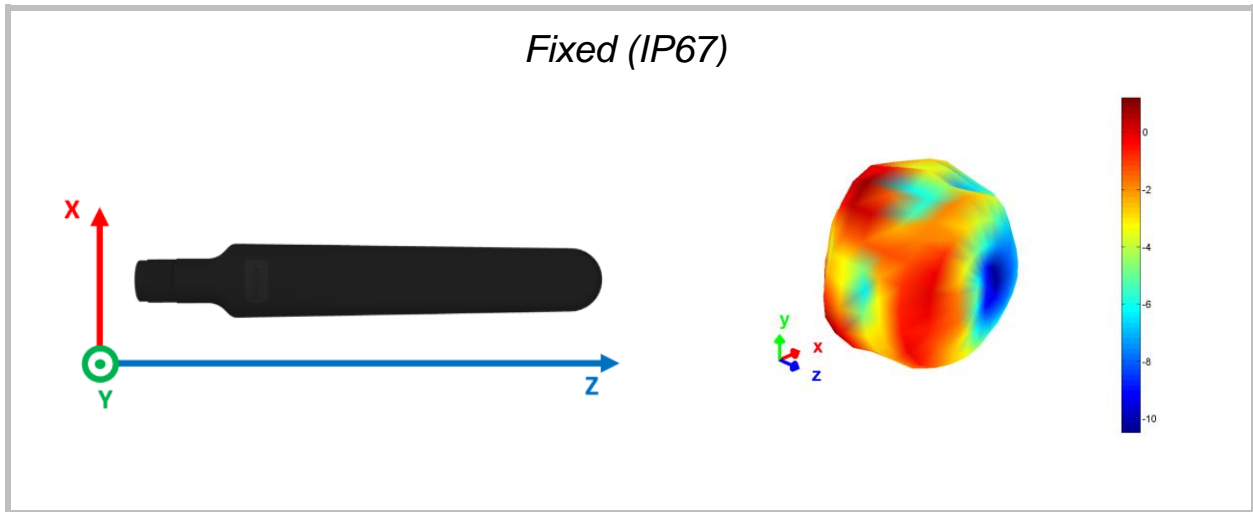

### 7.4.3 1710 MHz – 2170 MHz 3D patterns at 1970MHz

*Drag to rotate pattern and PCB by using Adobe Reader  
(Click to Activate)*

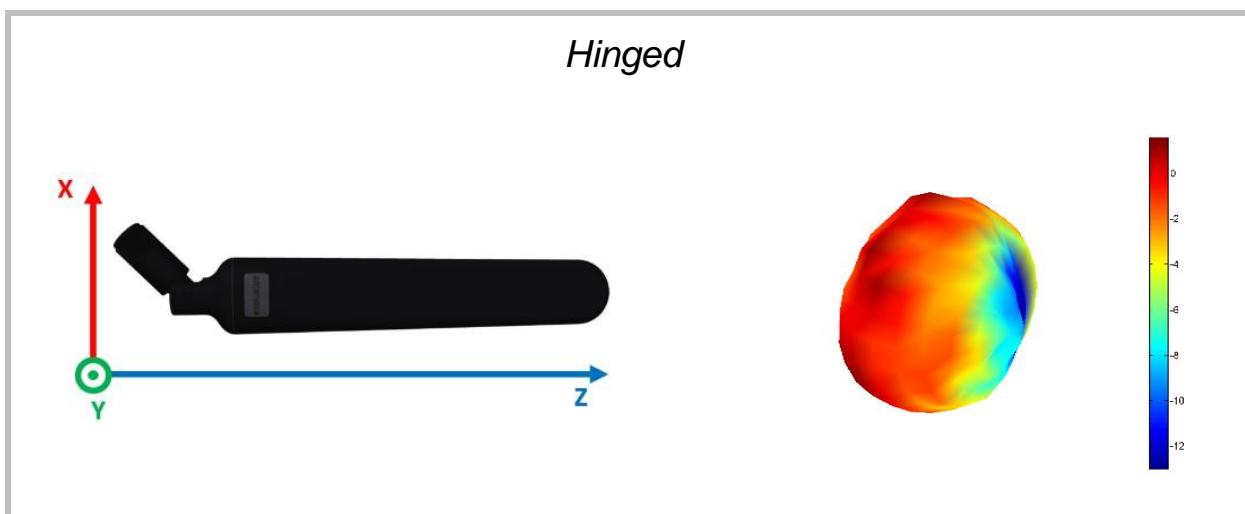
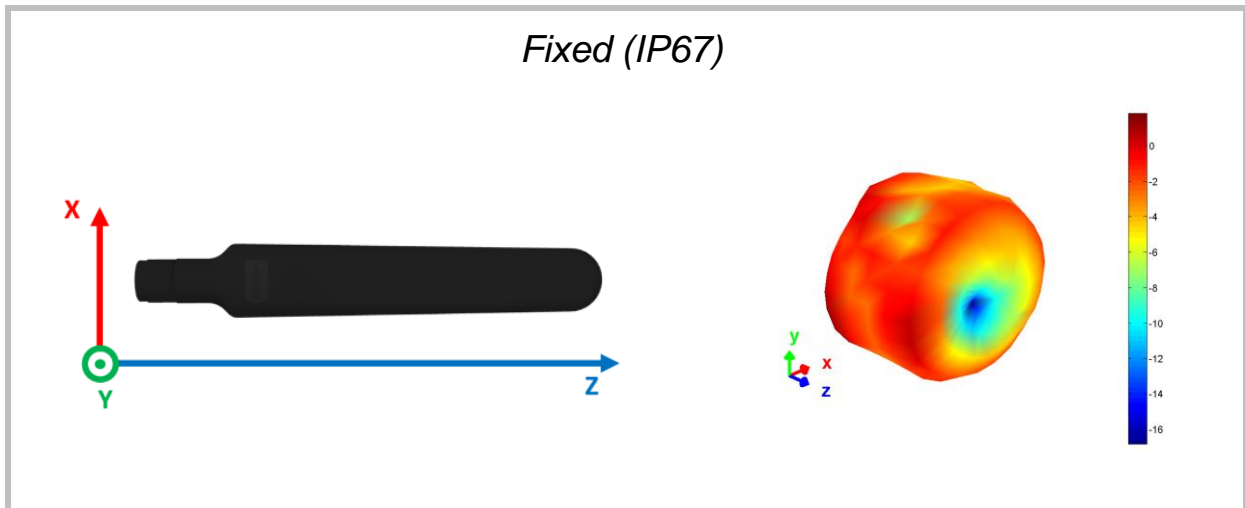

### 7.4.4 2300 MHz – 2400 MHz 3D patterns at 2360MHz

*Drag to rotate pattern and PCB by using Adobe Reader  
(Click to Activate)*

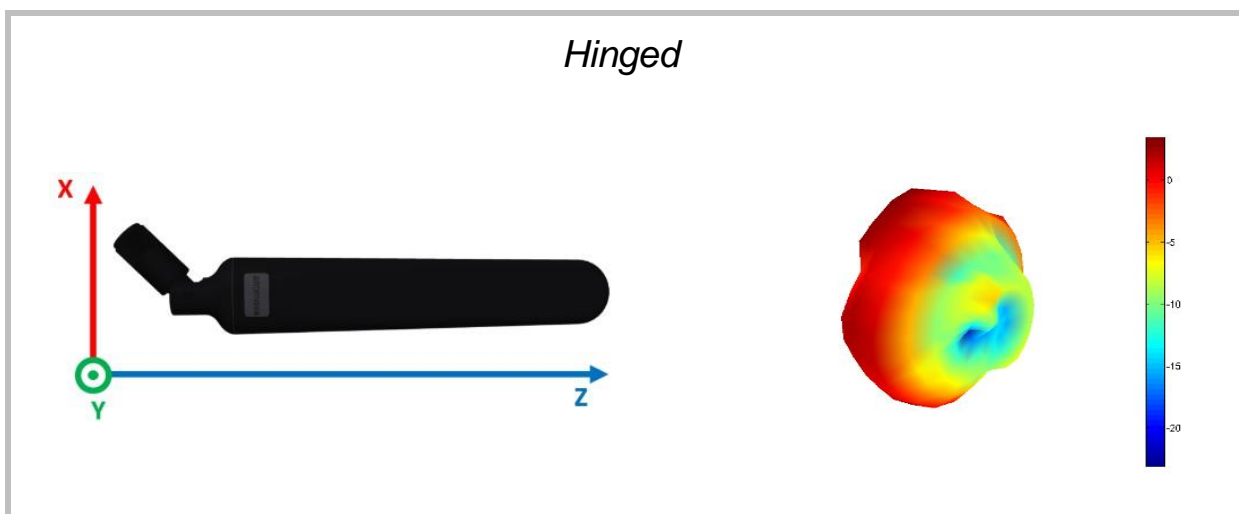
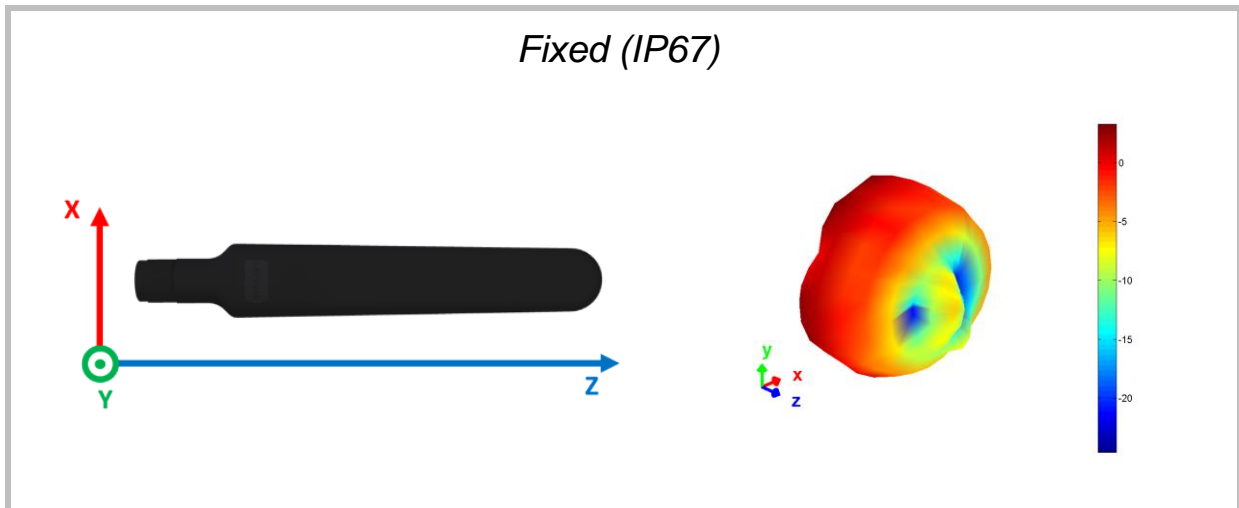



### 7.4.5 2500 MHz – 2690 MHz 3D patterns at 2600MHz

*Drag to rotate pattern and PCB by using Adobe Reader  
(Click to Activate)*

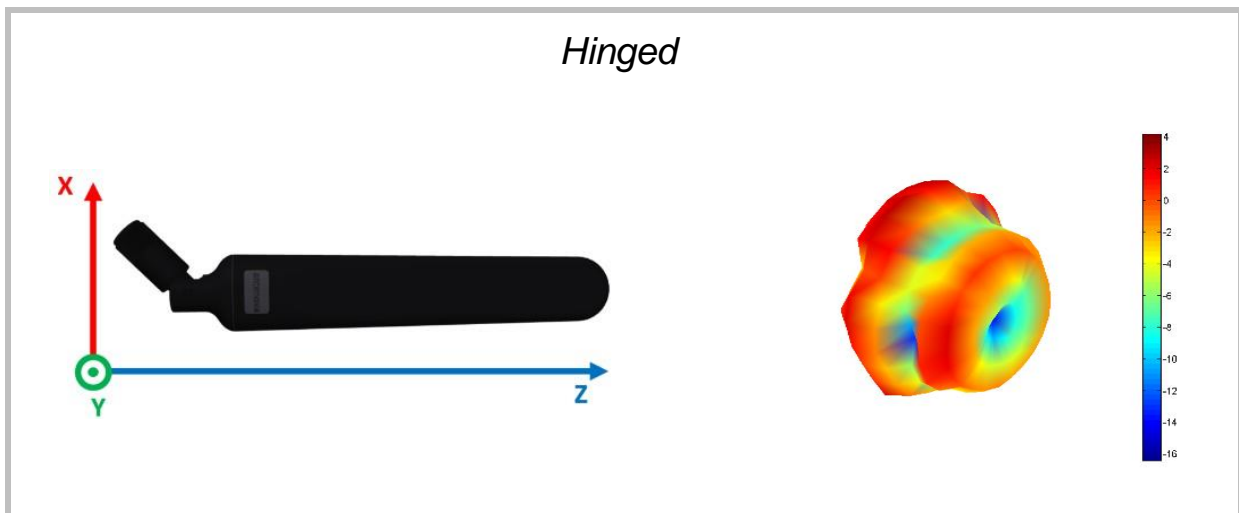
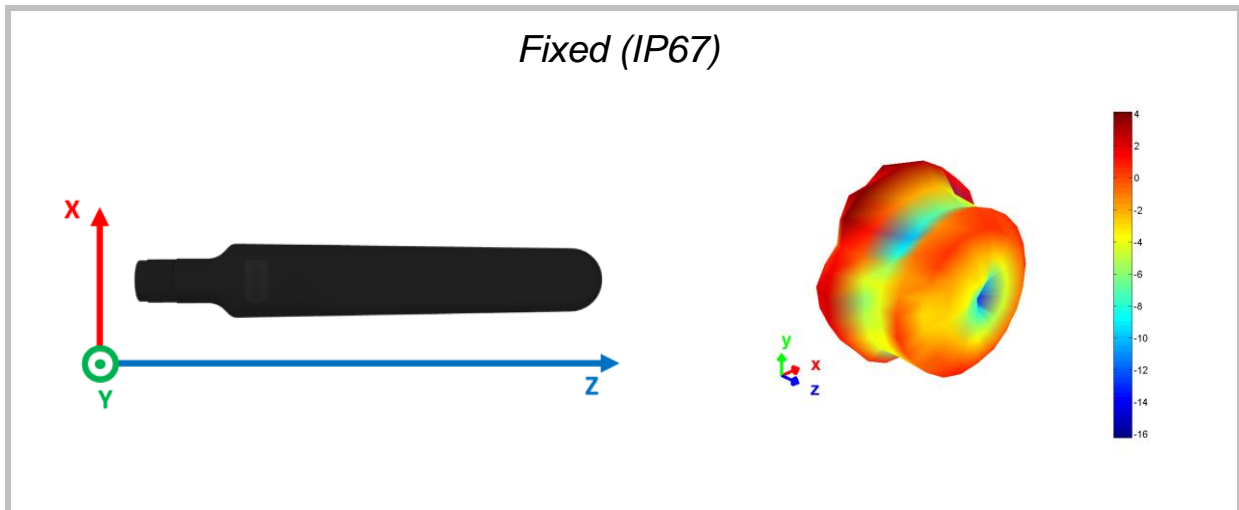

## 7.4.6 3200 MHz – 3800 MHz

### 3D patterns at 3500MHz

*Drag to rotate pattern and PCB by using Adobe Reader  
(Click to Activate)*

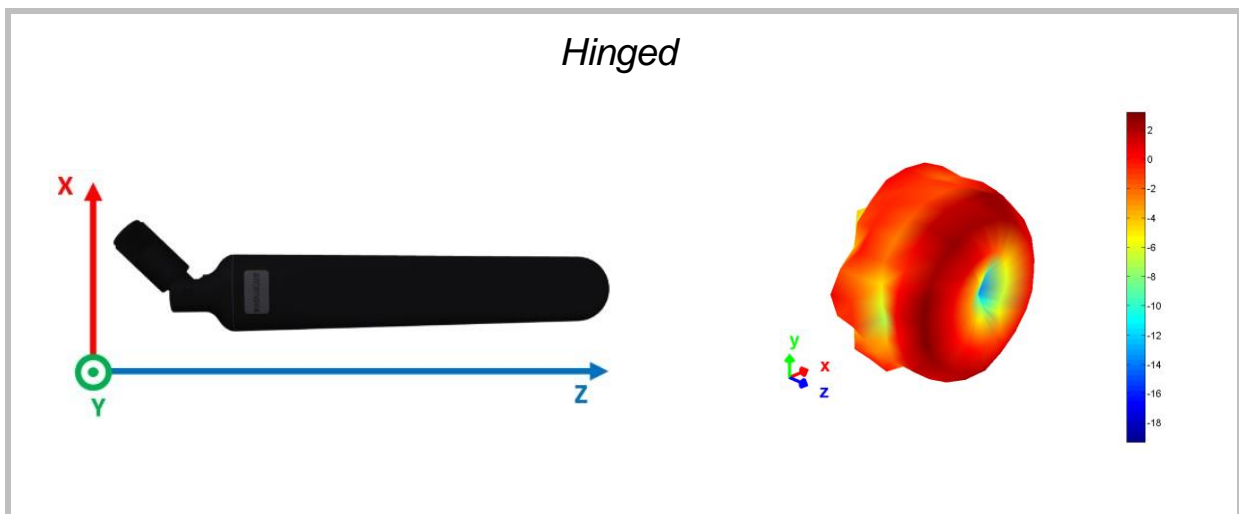
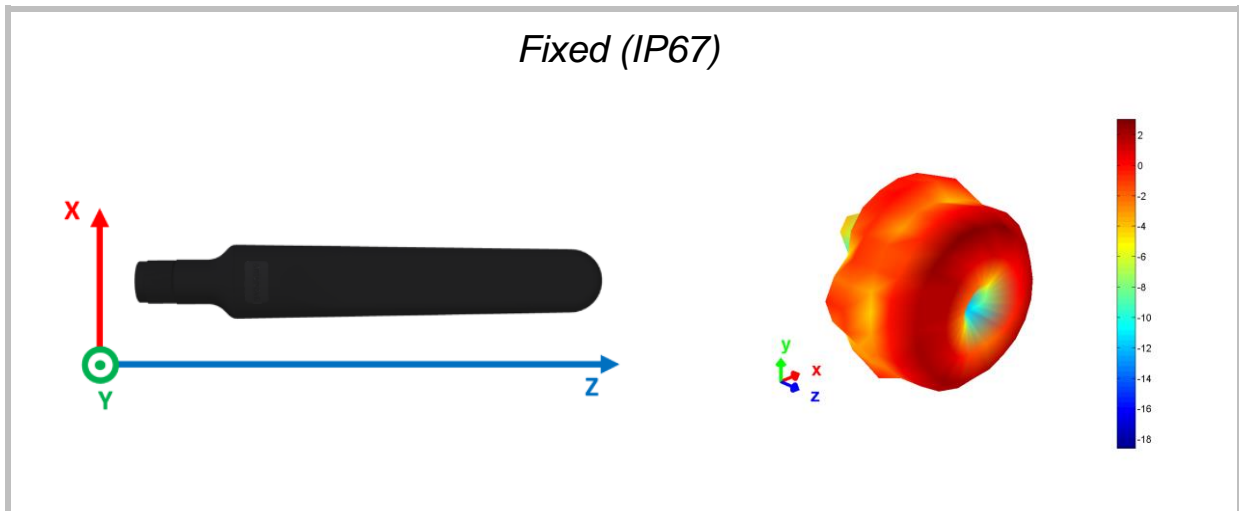

## 8. Antenna Dimensions

### 8.1 Dimensions Fixed (SREL062-IPP)

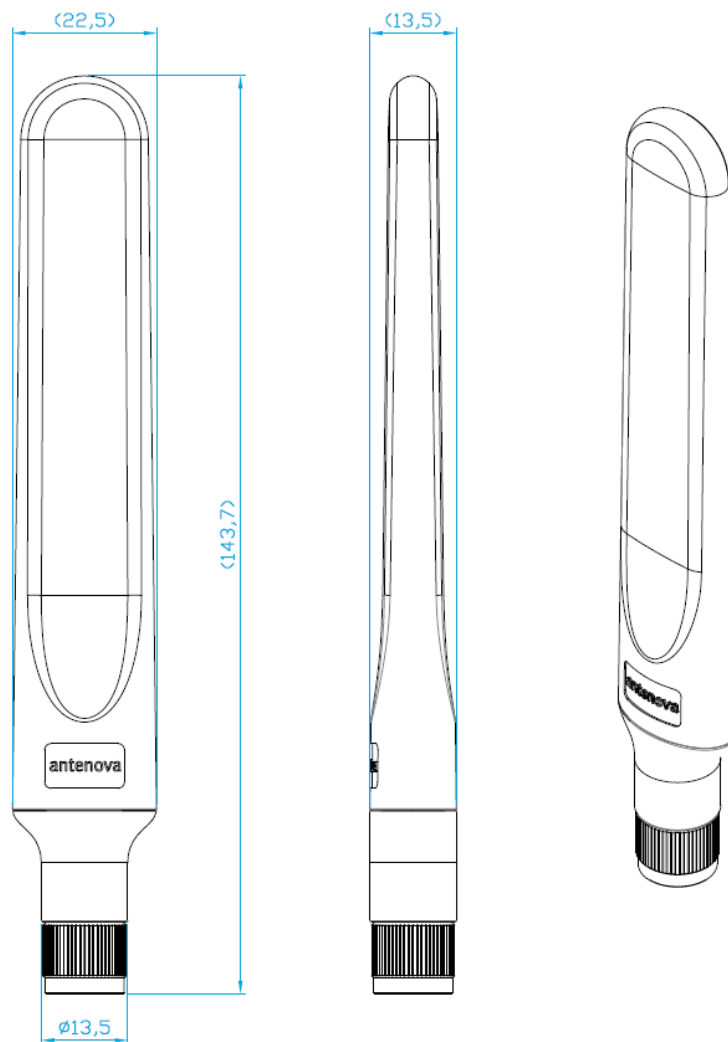

All dimensions in mm

## 8.1 Dimensions Hinged (SREL062-S9P)

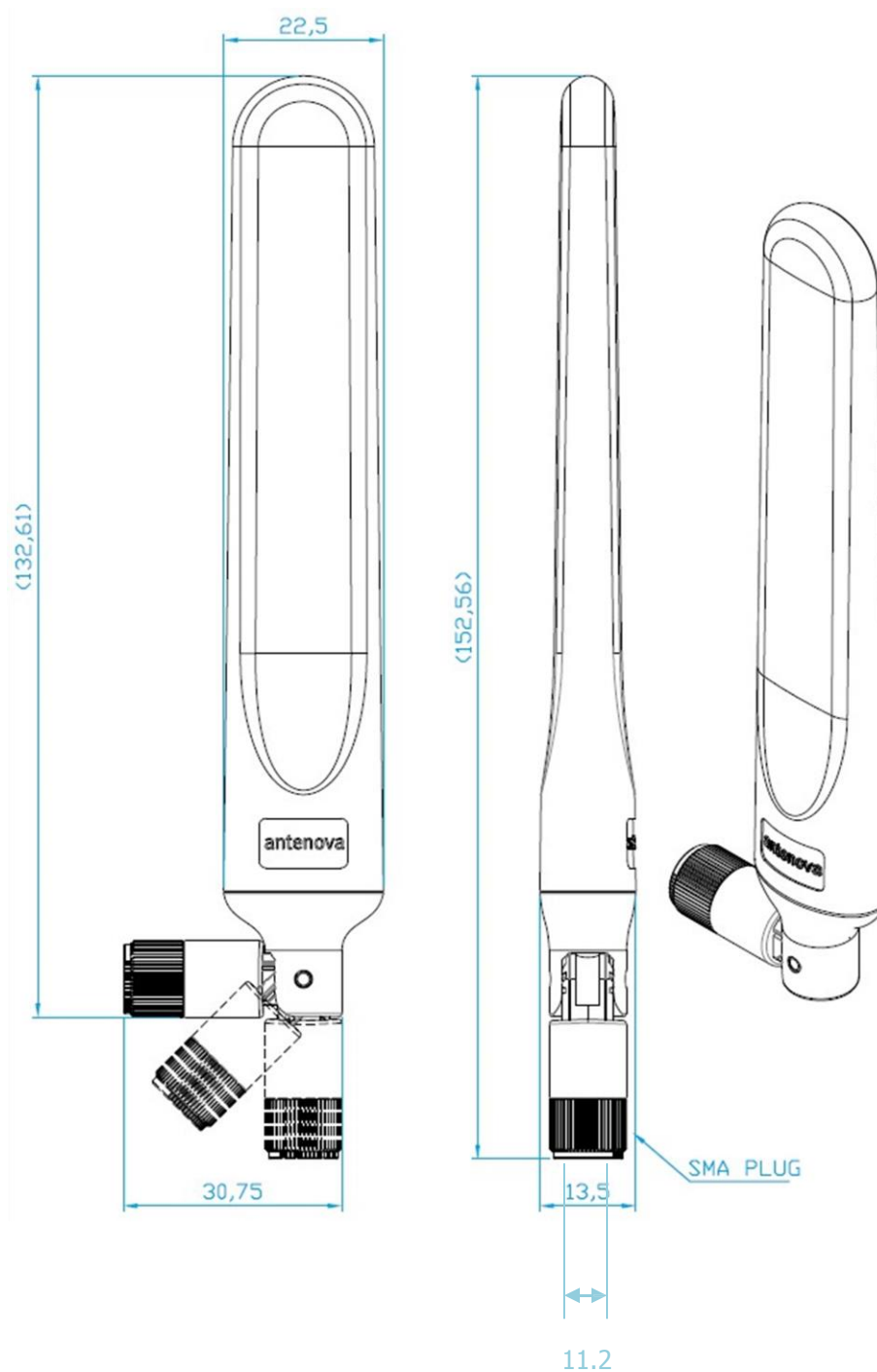

All dimensions in mm

## 9. Electrical Interface

### 9.1 Transmission Line

All transmission lines should be designed to have a characteristic impedance of 50Ω.

- The length of the transmission lines should be kept to a minimum
- Any other parts of the RF system like transceivers, power amplifiers, etc, should also be designed to have an impedance of 50 Ω

Once the material for the PCB has been chosen, (PCB thickness and dielectric constant) a coplanar transmission line can easily be designed using any of the commercial software packages for transmission line design. For the chosen PCB thickness, copper thickness and substrate dielectric constant, the program will calculate the appropriate transmission line width and gaps on either side of the feed.

A DC blocking capacitor should be placed in line to protect the RF front end.

## 10. Hazardous Material Regulation Conformance

The antenna has been tested to conform to RoHS requirements. A certificate of conformance is available from Antenova's website.

## 11. Packaging

### 11.1 Fixed (SREL062-IPP)

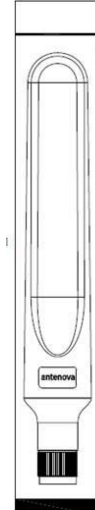

The antennas are supplied in individual polythene bags. Twenty five small bags are packed in one larger bag. The outer box contains fifty antennas.

### Box label

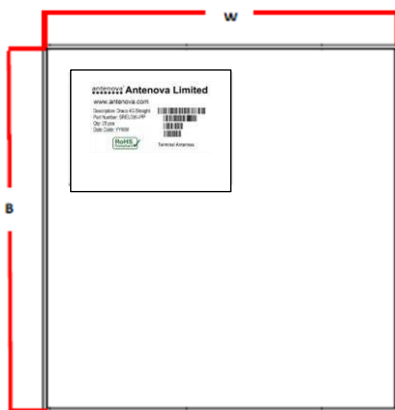

Width W	Breadth B	Thickness H
355 mm	340 mm	58 mm

## 11.2 Hinged (SREL062-S9P)

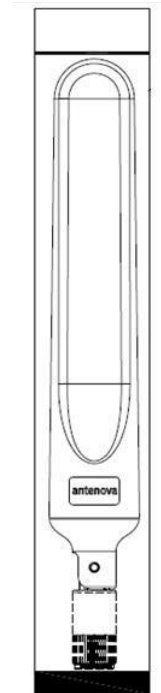

The antennas are supplied in individual polythene bags. Twenty five small bags are packed in one larger bag. The outer box contains fifty antennas.

### Box label

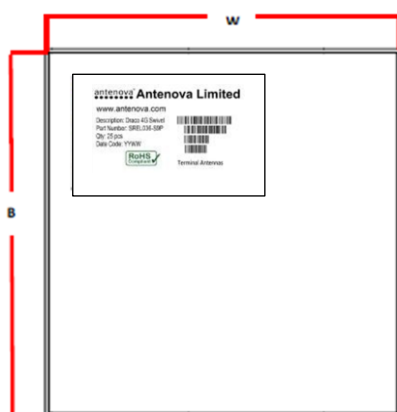

Width W	Breadth B	Thickness H
355 mm	340 mm	58 mm

## 12. Optimal Storage Conditions

Temperature	-10°C to 40°C
Humidity	Less than 75% RH
Shelf life	18 Months
Storage place	Away from corrosive gas and direct sunlight
Packaging	Antennas should be stored in unopened sealed manufacturer's plastic packaging.



## 13. Label Information

antenova® **Antenova Limited**

www.antenova.com

Description: Rabo 5G Swivel  
Part Number: SREL062-S9P  
Qty: 25 pcs  
Date Code: YYWW

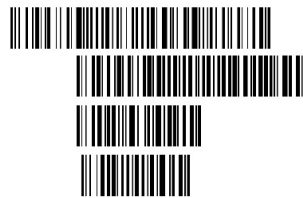

Terminal Antennas



antenova® **Antenova Limited**

www.antenova.com

Description: Rabo 5G Straight  
Part Number: SREL062-IPP  
Qty: 25 pcs  
Date Code: YYWW

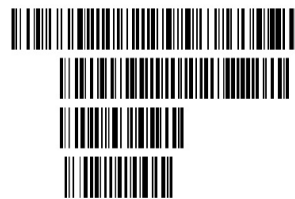

Terminal Antennas

