

Dual Common Cathode Schottky Rectifier

FEATURES

- Low power loss, high efficiency
- Guardring for overvoltage protection
- High surge current capability
- UL Recognized File # E-326243
- Compliant to RoHS Directive 2011/65/EU and in accordance to WEEE 2002/96/EC
- Halogen-free according to IEC 61249-2-21 definition

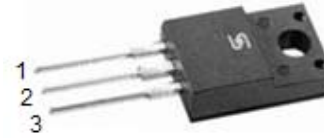

ITO-220AB

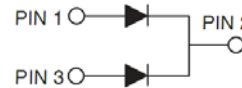

MECHANICAL DATA

Case: ITO-220AB

Molding compound, UL flammability classification rating 94V-0

Base P/N with suffix "G" on packing code - halogen-free

Base P/N with prefix "H" on packing code - AEC-Q101 qualified

Terminal: Matte tin plated leads, solderable per JESD22-B102

Meet JESD 201 class 1A whisker test

with prefix "H" on packing code meet JESD 201 class 2 whisker test

Polarity: As marked

Mounting torque: 5 in-lbs maximum

Weight: 1.7 g (approximately)

MAXIMUM RATINGS AND ELECTRICAL CHARACTERISTICS (T _A =25°C unless otherwise noted)											
PARAMETER	SYMBOL	SRF 2020	SRF 2030	SRF 2040	SRF 2050	SRF 2060	SRF 2090	SRF 20100	SRF 20150	UNIT	
Maximum repetitive peak reverse voltage	V _{RRM}	20	30	40	50	60	90	100	150	V	
Maximum RMS voltage	V _{RMS}	14	21	28	35	42	63	70	105	V	
Maximum DC blocking voltage	V _{DC}	20	30	40	50	60	90	100	150	V	
Maximum average forward rectified current	I _{F(AV)}	20								A	
Peak forward surge current, 8.3 ms single half sine-wave superimposed on rated load	I _{FSM}	200								A	
Maximum Instantaneous Forward Voltage (Note 1) I _F = 10 A	V _F	0.55			0.70		0.92		1.02	V	
Maximum reverse current @ Rated VR T _J =25 °C T _J =100 °C T _J =125 °C	I _R	0.5					0.1				mA
		15			10		-				
		-					5				
Typical thermal resistance	R _{θJC}	1.5								°C/W	
Operating junction temperature range	T _J	- 55 to +125				- 55 to +150					°C
Storage temperature range	T _{STG}	- 55 to +150									°C

Note 1: Pulse test with PW=300µs, 1% duty cycle

ORDERING INFORMATION					
PART NO.	AEC-Q101 QUALIFIED	PACKING CODE	GREEN COMPOUND CODE	PACKAGE	PACKING
SRF20xx (Note 1)	Prefix "H"	C0	Suffix "G"	ITO-220AB	50 / Tube

Note 1: "xx" defines voltage from 20V (SRF2020) to 150V (SRF20150)

EXAMPLE					
PREFERRED P/N	PART NO.	AEC-Q101 QUALIFIED	PACKING CODE	GREEN COMPOUND CODE	DESCRIPTION
SRF2060 C0	SRF2060		C0		
SRF2060 C0G	SRF2060		C0	G	Green compound
SRF2060HC0	SRF2060	H	C0		AEC-Q101 qualified

RATINGS AND CHARACTERISTICS CURVES

(TA=25°C unless otherwise noted)

FIG.1 FORWARD CURRENT DERATING CURVE

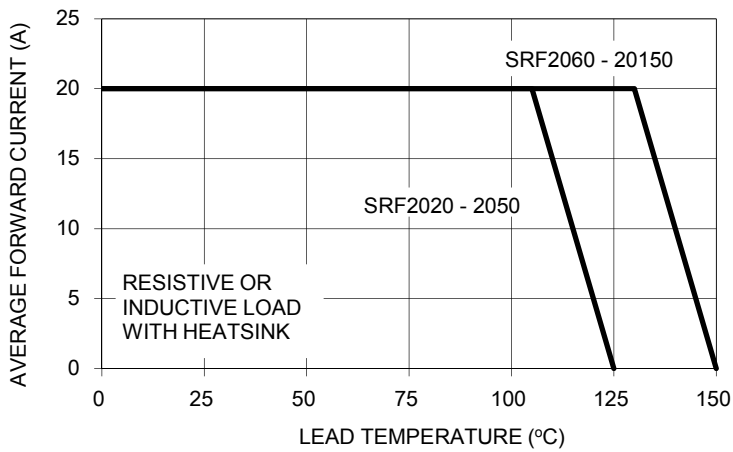

FIG. 2 MAXIMUM NON-REPETITIVE FORWARD SURGE CURRENT

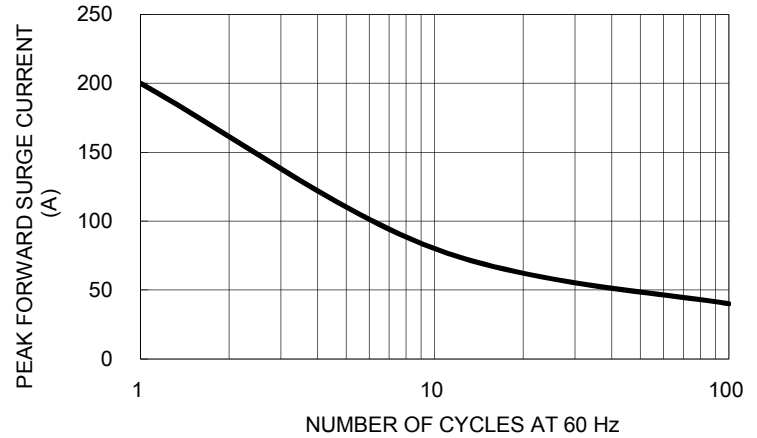

FIG. 3 TYPICAL FORWARD CHARACTERISTICS

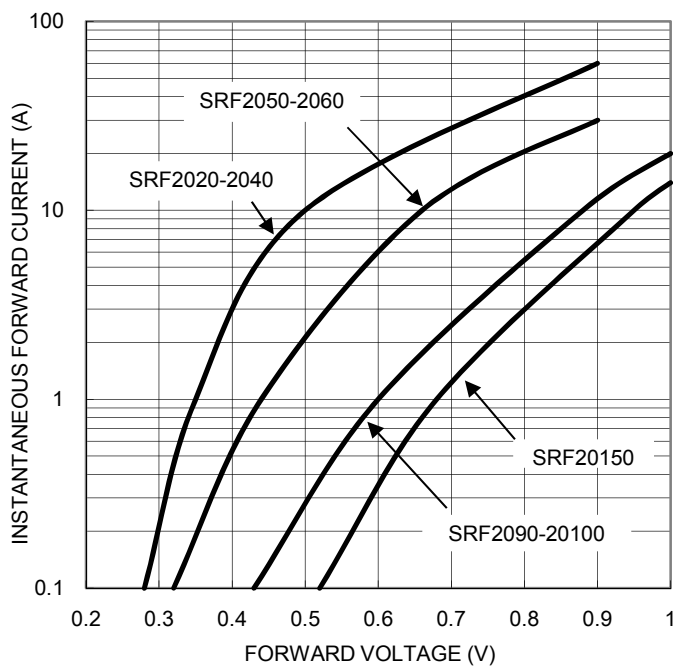

FIG. 4 TYPICAL REVERSE CHARACTERISTICS

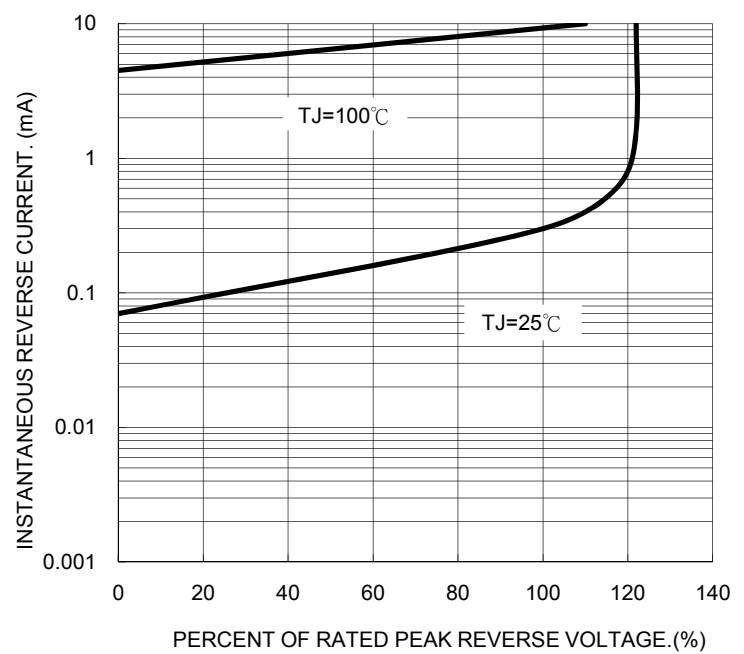

FIG. 5 TYPICAL JUNCTION CAPACITANCE

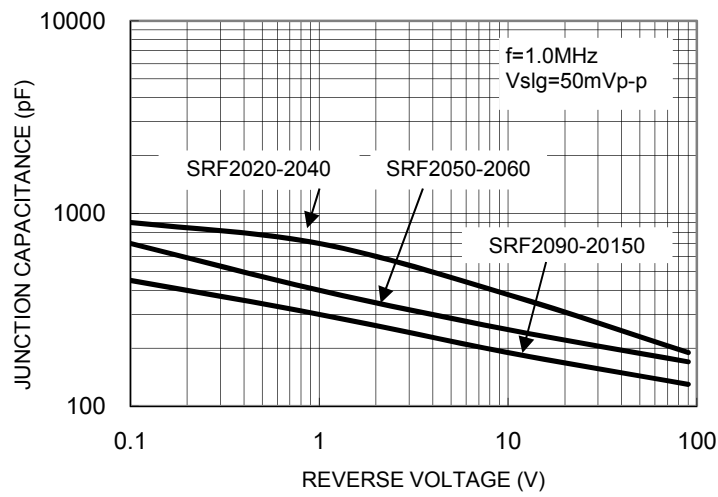
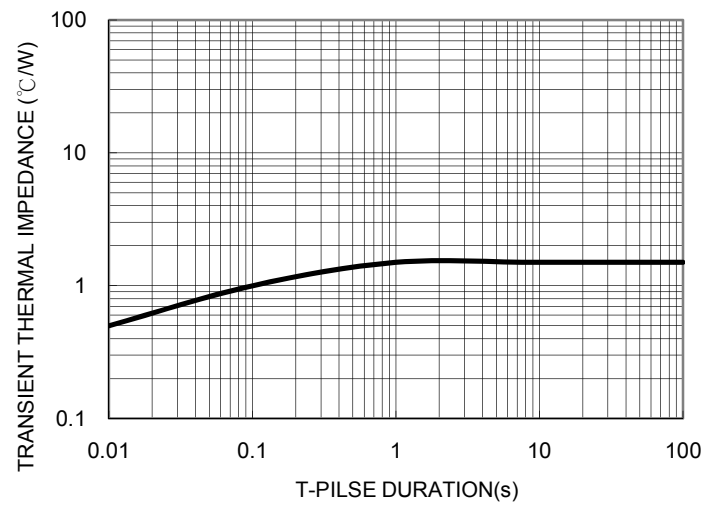
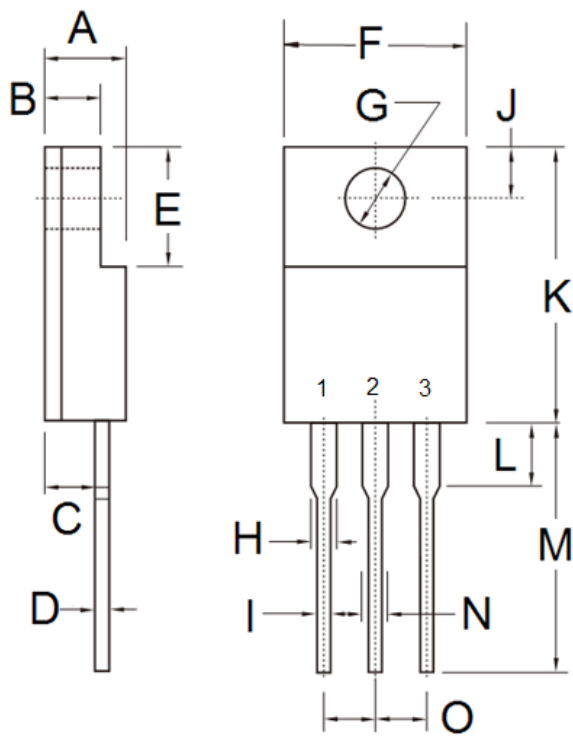

FIG. 6 TYPICAL TRANSIENT THERMAL IMPEDANCE



PACKAGE OUTLINE DIMENSIONS



DIM.	Unit (mm)		Unit (inch)	
	Min	Max	Min	Max
A	4.30	4.70	0.169	0.185
B	2.50	3.16	0.098	0.124
C	2.30	2.96	0.091	0.117
D	0.46	0.76	0.018	0.030
E	6.30	6.90	0.248	0.272
F	9.60	10.30	0.378	0.406
G	3.00	3.40	0.118	0.134
H	0.95	1.45	0.037	0.057
I	0.50	0.90	0.020	0.035
J	2.40	3.20	0.094	0.126
K	14.80	15.50	0.583	0.610
L	-	4.10	-	0.161
M	12.60	13.80	0.496	0.543
N	-	1.80	-	0.071
O	2.41	2.67	0.095	0.105

MARKING DIAGRAM



- P/N = Specific Device Code
- G = Green Compound
- YWW = Date Code
- F = Factory Code