

Avia 3G FPC Antenna

Part No. SRFC025

flexiiANT[®]

Product Specification

1. Features

- Antenna for 3G applications including MIMO systems.
- GSM850, GSM900, DCS1800, PCS1900, WCDMA2100
- 1.13mm diameter RF cable with IPEX MHF connector
- Self-adhesive mounted
- Quick and simple integration minimizes design cycle
- Available in 3 standard cable lengths

2. Description

Avia is intended for use with 3G applications. This product specification shows the performance of the antenna to cover a typical penta-band reception: GSM850/900/1800/1900 and WCDMA.

3. Applications

- Smart meters
- Femto / Pico base stations
- Tracker devices
- Remote monitoring
- Machine to Machine
- POS (Point of Sale) terminals



4. Part Number

Avia: SRFC025



5. General Data

Product name	Avia GSM antenna
Part Number	SRFC025
Frequency	824-960MHz; 1710-2170MHz
Polarization	Linear
Operating temperature	-40°C to 85°C
Impedance with matching	50 Ω
Weight	< 0.5 g
Antenna type	FPC Self-adhesive 3M 468P
Dimensions (Antenna)	71.0 x 12.5 x 0.15 (mm)
Connection	IPEX

6. RF Characteristics

	824 – 960 MHz	1710 – 1990 MHz	2110 – 2170 MHz
Peak gain	4.07dBi	5.44dBi	3.9dBi
Average gain	-3.31dBi	-1.1dBi	-1.74dBi
Average efficiency	>45%	>70%	>65%
Maximum return loss	-6.6dB	-8.7dB	-17dB
Maximum VSWR	2.80:1	2.20:1	1.30:1

All data measured in a loaded condition
adhered to a plastic carrier free space.

7. RF Performance

7.1 Return Loss

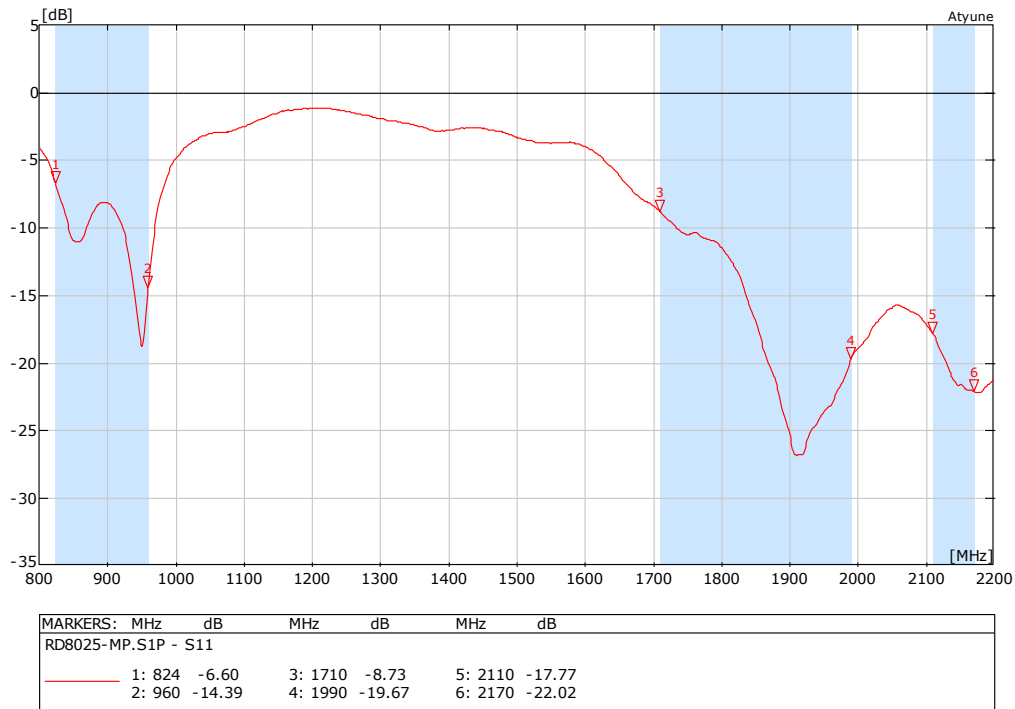

7.2 VSWR

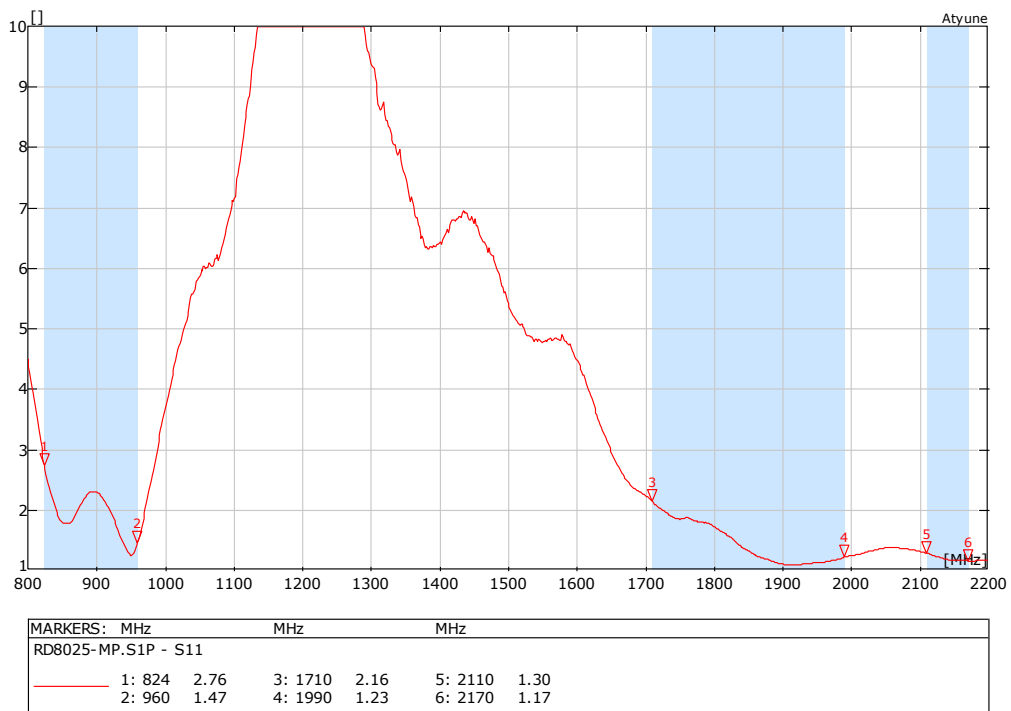

7.3 Antenna patterns

7.3.1 824 MHz – 960 MHz

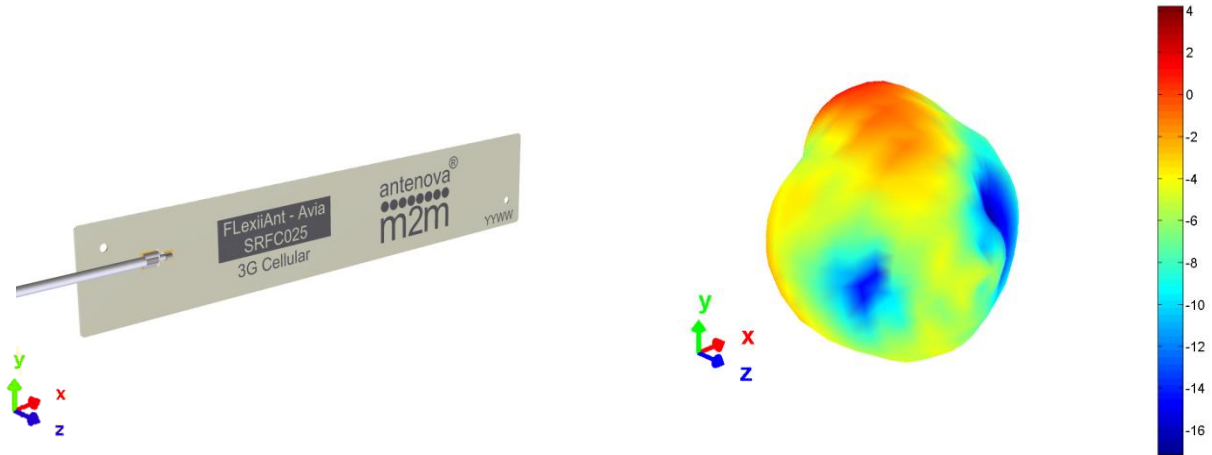

3D pattern at 890 MHz

Drag to rotate pattern and PCB by using Adobe Reader
(Click to Activate)

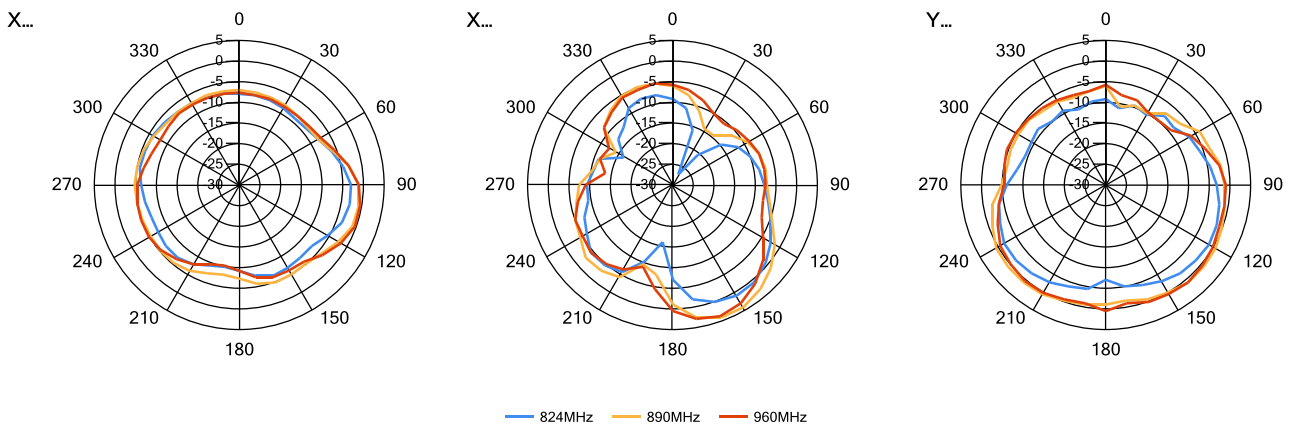

7.3.2 1710 MHz – 2170 MHz

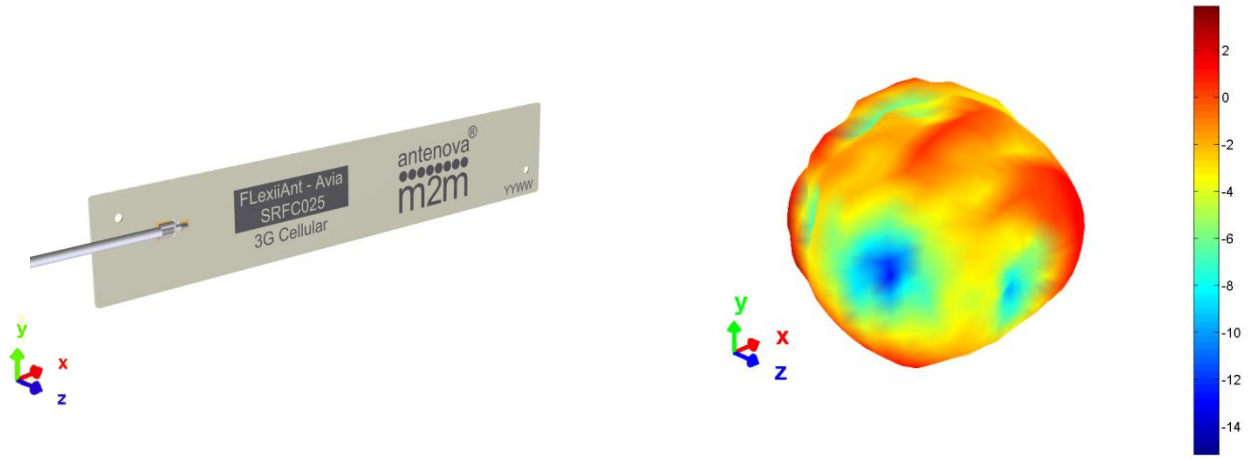

3D pattern at 1950 MHz
*Drag to rotate pattern and PCB by using Adobe Reader
(Click to Activate)*

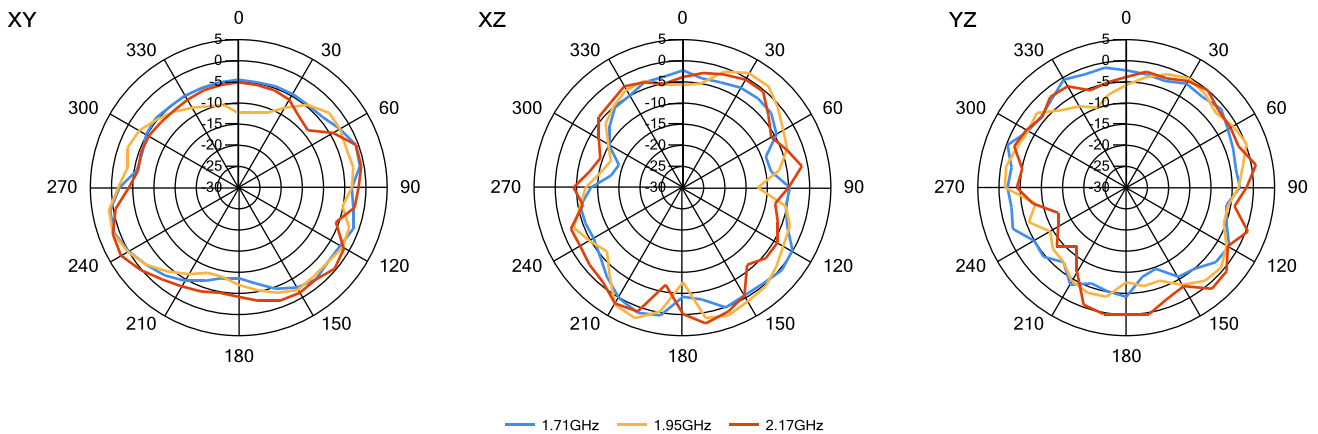

8. Antenna Dimensions

8.1 Dimensions FPC section

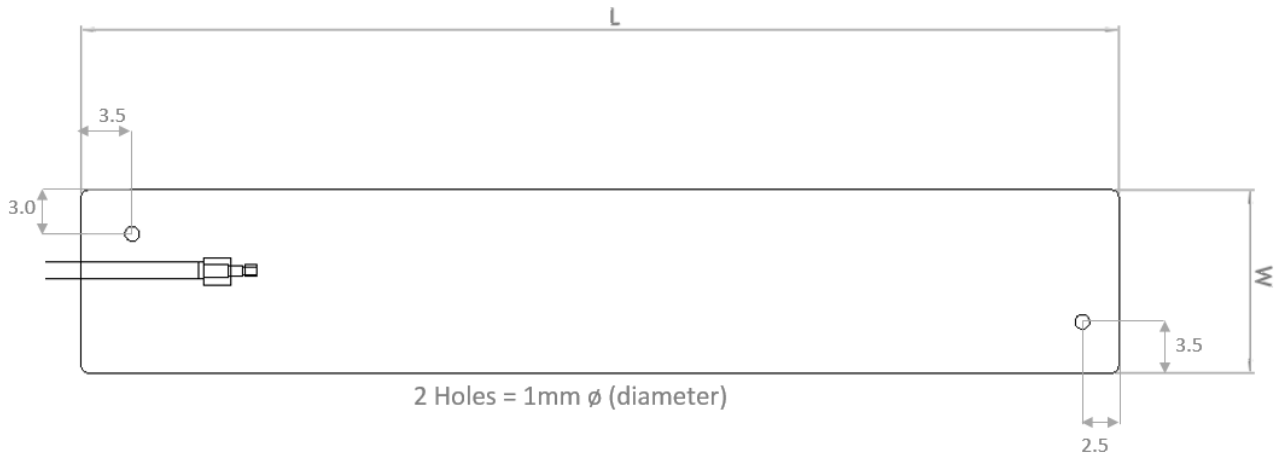

L	W	T
Length	Width	Thickness
71.0 \pm 0.2 (mm)	12.5 \pm 0.2 (mm)	0.15 (mm) nominal

All dimensions in mm

8.2 Dimensions assembled

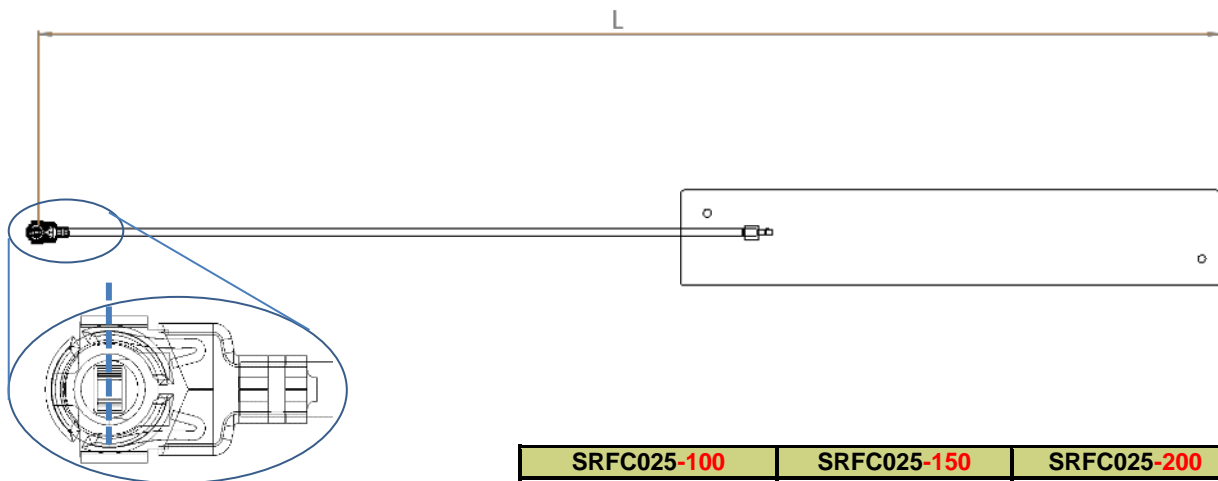

SRFC025-100	SRFC025-150	SRFC025-200
L	L	L
160 \pm 2.0 (mm)	210 \pm 2.0 (mm)	260 \pm 2.0 (mm)

Antennas for Wireless M2M Applications

8.3 IPEX Connector

I-PEX	
Material	Copper Alloy
Plating	Ag

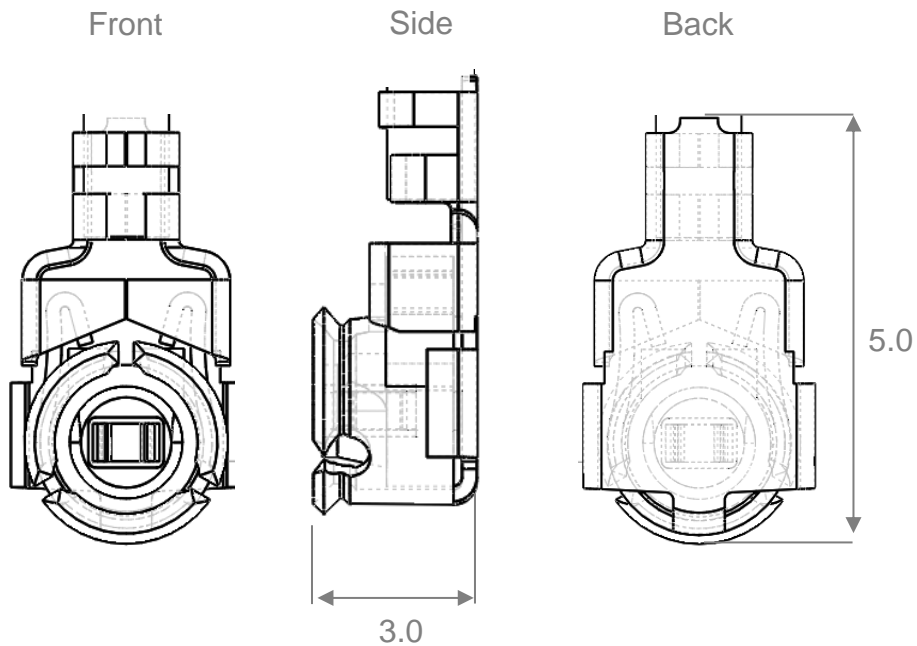

All dimensions in mm

8.4 Assembly

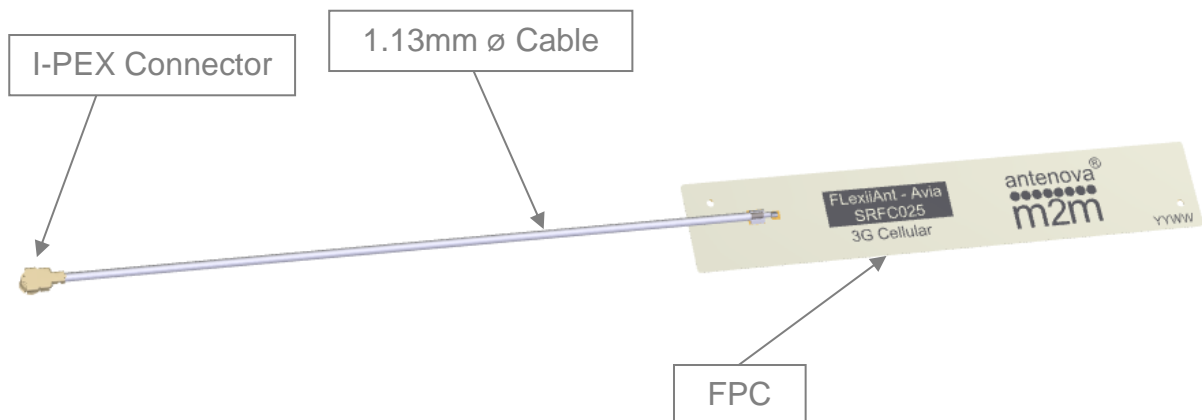

Antennas for Wireless M2M Applications

9. Electrical Interface

9.1 Host Interface

The host PCB requires the mating connector which is IPEX MHF (UFL) receptacle. The location should be close to the chip/modules pin for the RF. Any feed from this receptacle should be maintained at 50Ω impedance.

9.2 Transmission Line

All transmission lines should be designed to have a characteristic impedance of 50Ω.

- The length of the transmission lines should be kept to a minimum
- Any other parts of the RF system like transceivers, power amplifiers, etc, should also be designed to have an impedance of 50 Ω

Once the material for the PCB has been chosen (PCB thickness and dielectric constant), a coplanar transmission line can easily be designed using any of the commercial software packages for transmission line design. For the chosen PCB thickness, copper thickness and substrate dielectric constant, the program will calculate the appropriate transmission line width and gaps on either side of the feed.

A DC blocking capacitor should be placed in line to protect the RF front end.

10. Mechanical Fixing

The antenna uses 3M 468MP adhesive on the reverse side of the FPC. The antenna has an easy access split line to peel off to reveal the adhesive side. It is designed for a one time fix to a clean smooth surface.

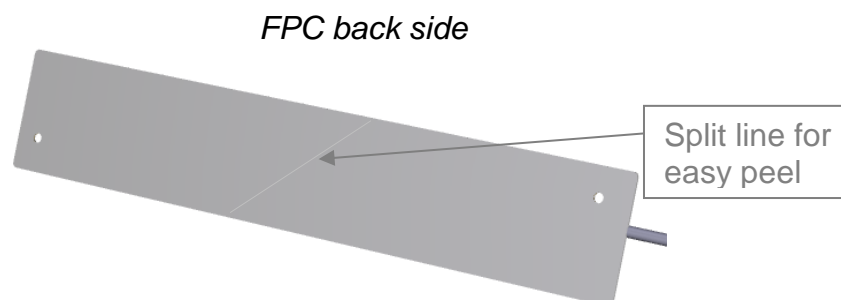

10.0 Antenna Integration Guide

10.1 Placement

For placing the FPC antenna within a device, the host PCB size is not a factor like with PCB mounted antennas. However placement still needs to follow some basic rules, as any antenna is sensitive to its environment.

Using six spatial directions shown below as a guide. The antenna FPC section should try to maintain a minimum of three directions free from obstructions to be able to operate effectively. The other directions will have obstacles in their paths, these directions still require a minimum clearance. These minimum clearances are further defined in this section. The plastic case is not included in this, only metal objects/components that will obstruct or come in close proximity to the antenna.

Six spatial directions relative to FPC

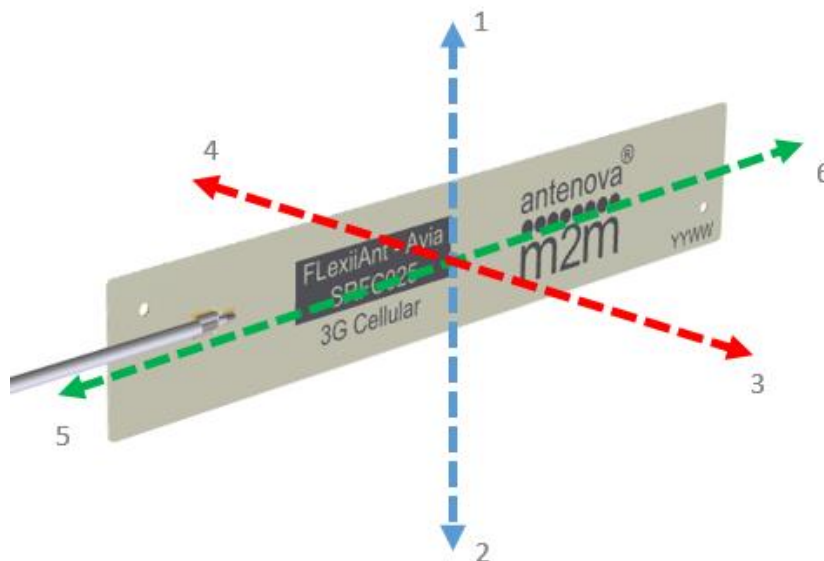

10.2 Orientation of FPC

The orientation of the FPC with respect to the host PCB should be defined depending on the unit. The proximity of the GND will have an influence on the antenna so the PCB location relative to the antenna should be considered.

The FPC will normally be placed in one of the three following options for orientation. In each option a distance (d) is the critical dimension to consider. Below shows the minimum value of (d) for each. Other obstructions may increase this dimension.

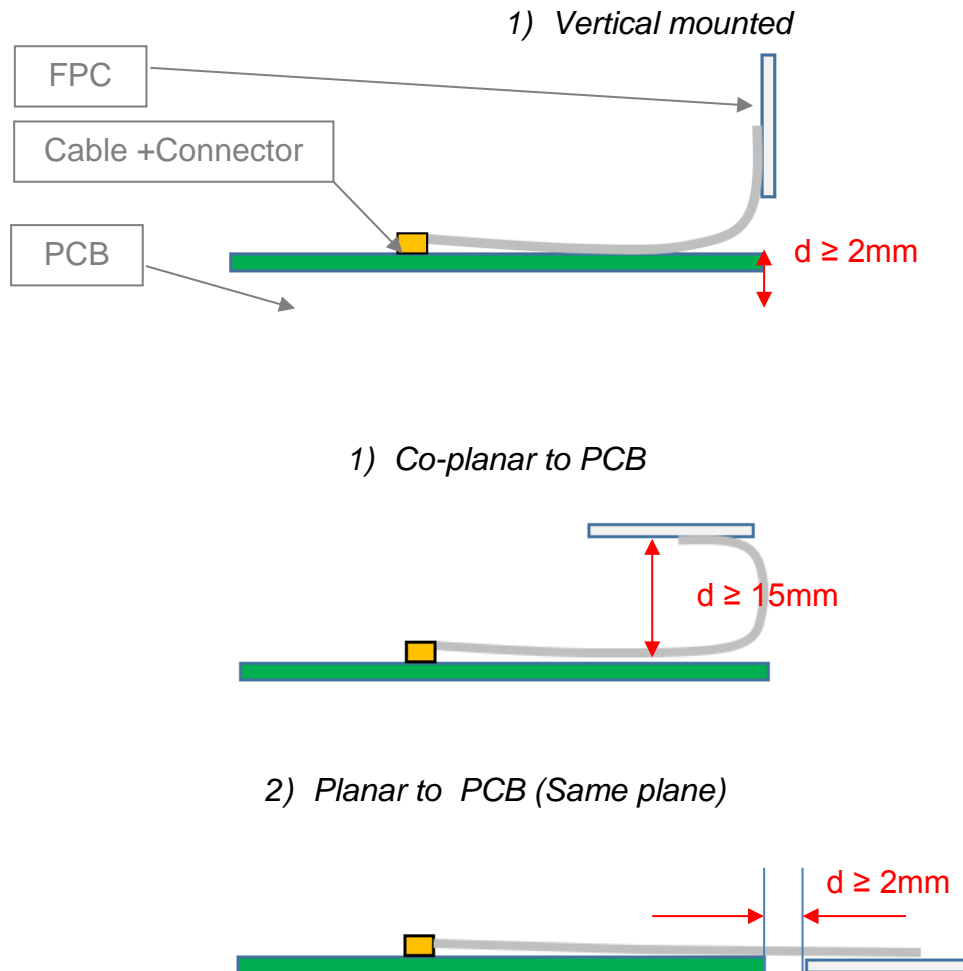

10.3 Host PCB size

The host PCB size has a large effect on the performance. It is recommended for the host PCB to be $>1600\text{mm}^2$. Any PCB which is smaller is advised to use Antenova SRFC011 as a suitable cellular FPC.

10.4 Device Integration example

An example of integration within a Telematics device. The FPC is shown adhered to the inside of the device's plastic housing. The cable routing is along the edge of the PCB so as not to interfere with any other component. The length of the cable is sufficient to allow ease of assembly when produced (SRFC025-100). The FPC is kept at maximised distance away from the PCB.

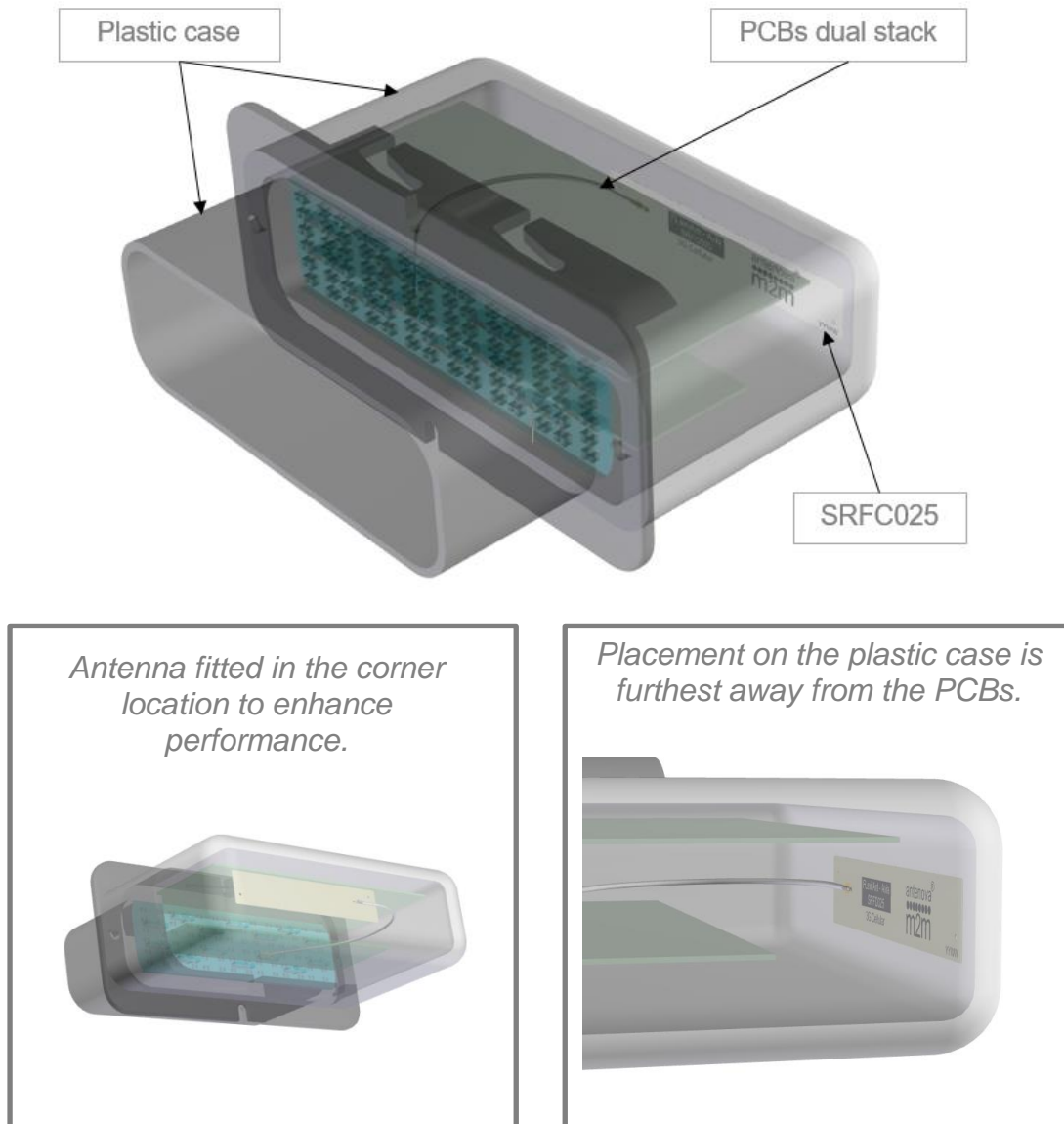

11. Hazardous Material Regulation Conformance

The antenna has been tested to conform to RoHS requirements. A certificate of conformance is available from Antenova M2M's website.

12. Packaging

The antennas are stored in individual plastic (PE) bags. Then stored within a second bag of 10pcs.

Single antenna per bag



10 units per second bag (Labelled)

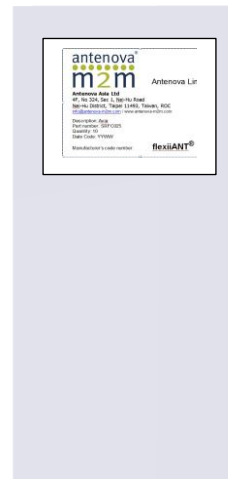

12.1 Optimal Storage Conditions

Temperature	-10°C to 40°C
Humidity	Less than 75% RH
Shelf life	18 Months
Storage place	Away from corrosive gas and direct sunlight
Packaging	Antennas should be stored in unopened sealed manufacturer's plastic packaging.

12.2 Label Information

