

DATASHEET

Fera

SRFI068 • flexiANT®

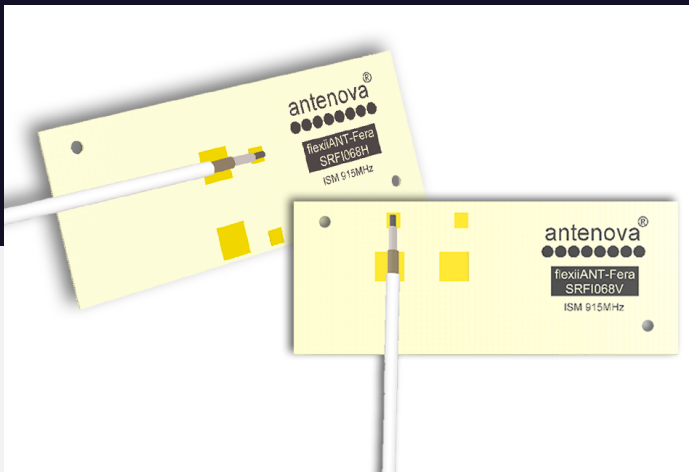

Features

- Antenna for all 915MHz ISM applications
- Maintains high performance within device: DFI (Designed For Integration)
- 1.13mm diameter RF cable with I-PEX MHF connector
- Self-adhesive mounted
- Quick integration minimizes design cycle
- High performance
- 100mm or 150mm cable – (other lengths available, MOQs apply)

Contents

1.	Description	2
2.	Applications	2
3.	General data	2
4.	Part number	3
5.	RF characteristics	3
6.	RF performance	4
6.1.	Return loss	4
6.2.	VSWR	4
6.3.	Antenna pattern	5
7.	Antenna dimensions	6
7.1.	Dimensions FPC section	6
7.2.	Dimensions assembled	6
7.3.	I-PEX connector MHF1 (20278-112R-13)	7
7.4.	Assembly	7
8.	Electrical interface	8
8.1.	Host interface	8
8.2.	Transmission line	8
9.	Mechanical fixing	8
10.	Antenna integration guide	9
10.1.	Antenna placement	9
10.2.	Orientation of FPC	10
11.	Hazardous material regulation conformance	11
12.	Packaging	11
12.1.	Optimal storage conditions	12
12.2.	Label information	12

1. Description

Fera is intended for use for all ISM 915MHz applications. A flexible antenna with cable enables direct connection to the host PCB giving easy integration with plug and play simplicity.

2. Applications

- Remote monitoring
- LoRa and Sigfox networks
- 915 MHz ISM band systems
- Smart meters
- Home automation
- Medical devices

3. General data

FREQUENCY	902-928MHz
POLARIZATION	Linear
OPERATING TEMPERATURE	-40°C to +85°C
ENVIRONMENTAL CONDITION TEST	ISO16750-4 5.1.1./5.1.2
IMPEDANCE	50 Ω
WEIGHT	<0.5g
ANTENNA TYPE	FPC Self-adhesive 3M 468MP
DIMENSIONS (ANTENNA)	33.0 x 13.0 x 0.15 (mm)
CONNECTION	I-PEX MHF1 (20278-112R-13)

4. Part number

FERA HORIZONTAL 100MM
SRFI068H-100

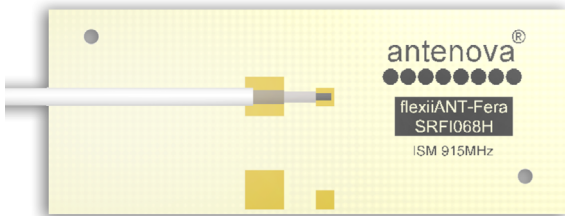

FERA VERTICAL 100MM
SRFI068V-100

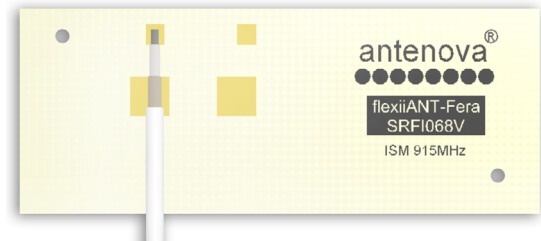

FERA HORIZONTAL 150MM
SRFI068H-150

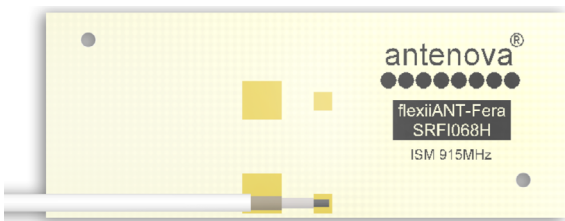

FERA VERTICAL 150MM
SRFI068V-150



5. RF characteristics

	902-928MHZ
PEAK GAIN	0.7dBi
AVERAGE GAIN (LINEAR)	-4.4dBi
AVERAGE EFFICIENCY	>36%
MAXIMUM RETURN LOSS	-15dB
MAXIMUM VSWR	1.4:1

All data measured on SRFI068V-100 in a loaded condition adhered to a plastic carrier in free space.

6. RF performance

6.1. Return loss

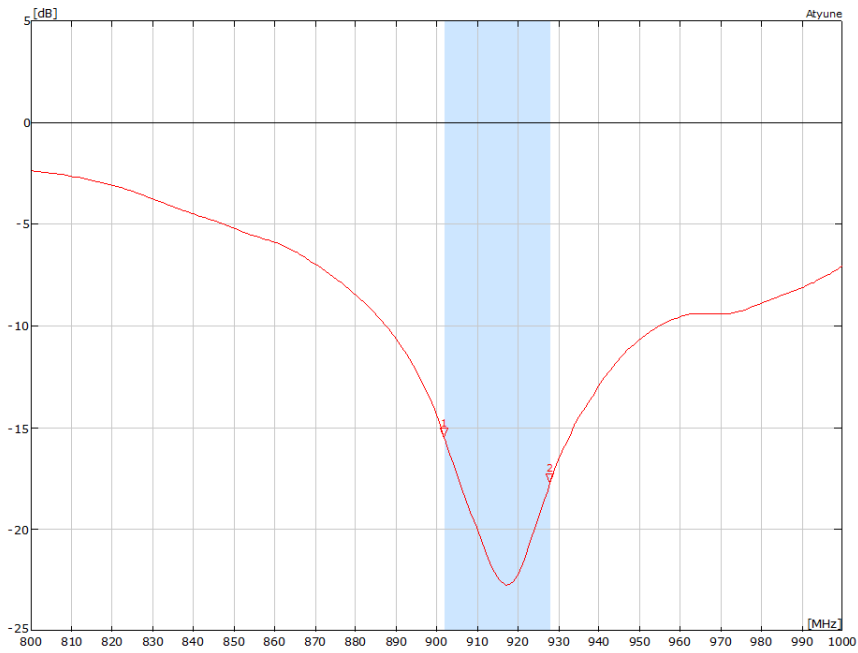

6.2. VSWR

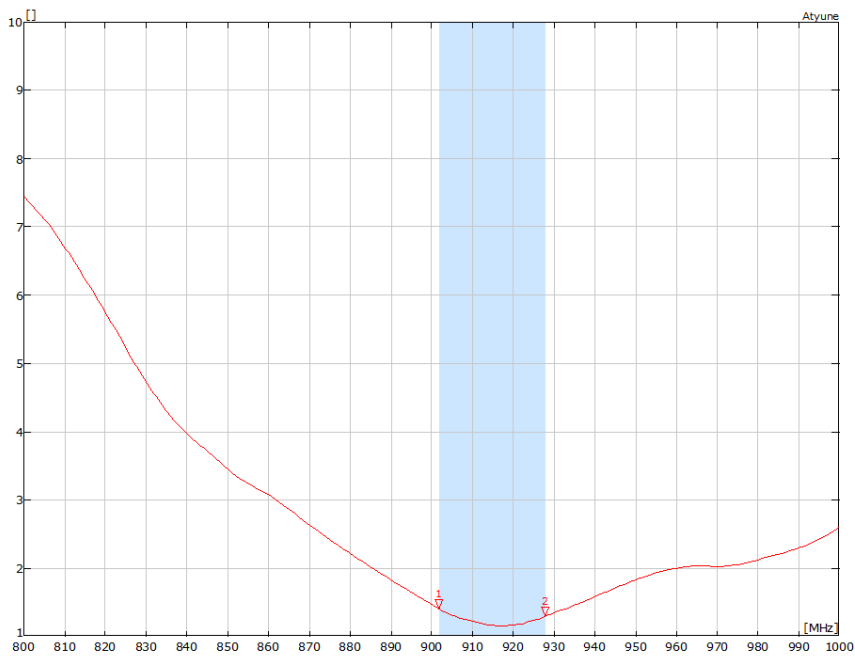

All data measured on SRFI068V-100 in a loaded condition adhered to a plastic carrier in free space.

6.3. Antenna pattern

6.3.1. 902 MHz – 928 MHz

3D pattern at 915MHz

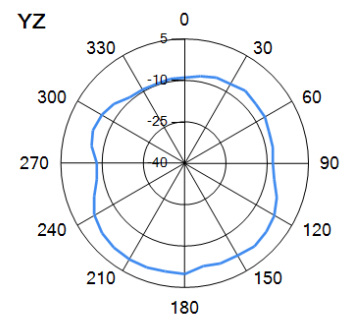
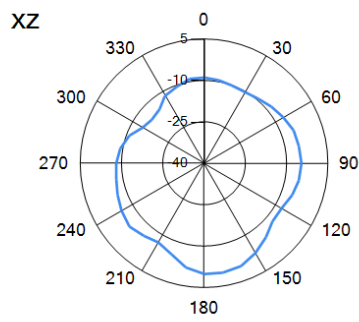
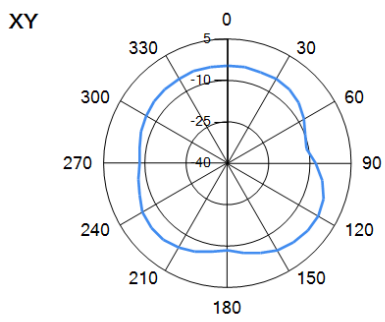
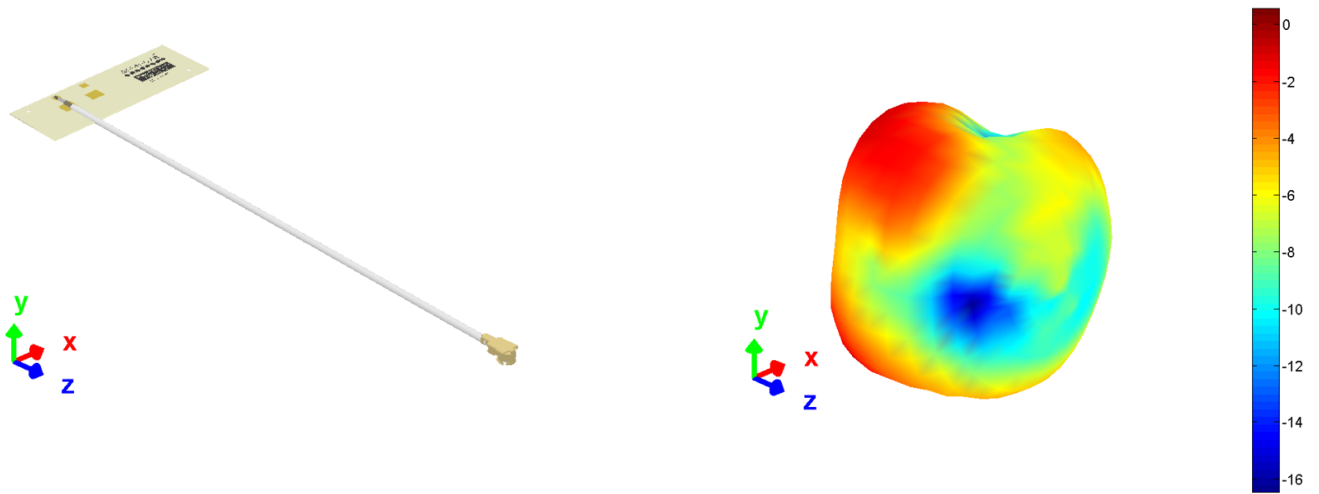

— 915MHz

7. Antenna dimensions

7.1. Dimensions FPC section

SRFI068H

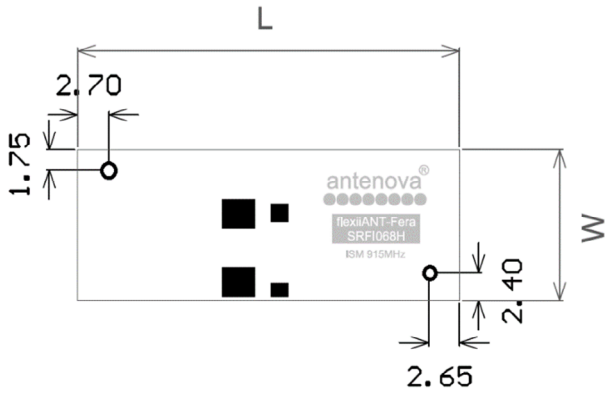

SRFI068V

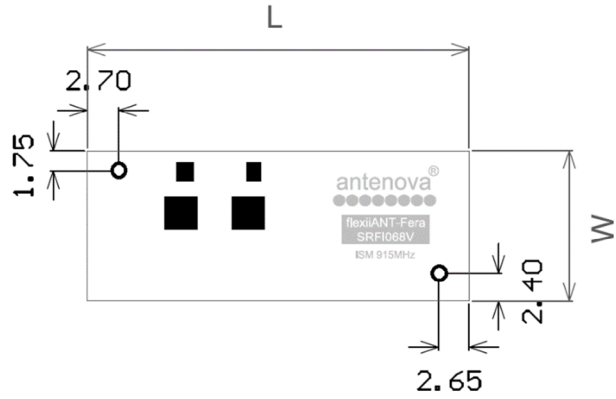

L	W	T
Length	Width	Thickness
33.0 ±0.2	13.0 ±0.2	0.15 (nominal)

All dimensions in (mm)

7.2. Dimensions assembled

SRFI068H

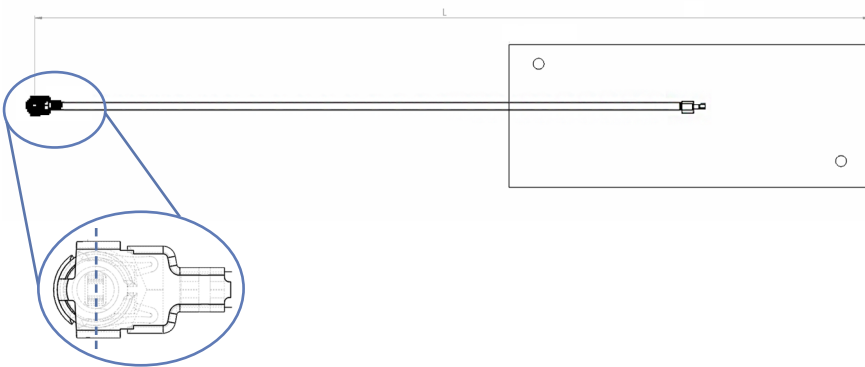

SRFI068H-100	SRFI068H-150	SRFI068V-100	SRFI068V-150
Length	Length	Length	Length
115 ±2.0	165 ±2.0	101.3 ±2.0	151.3 ±2.0

All dimensions in (mm)

Standard cable lengths for this antenna are 100mm and 150mm

SRFI068V

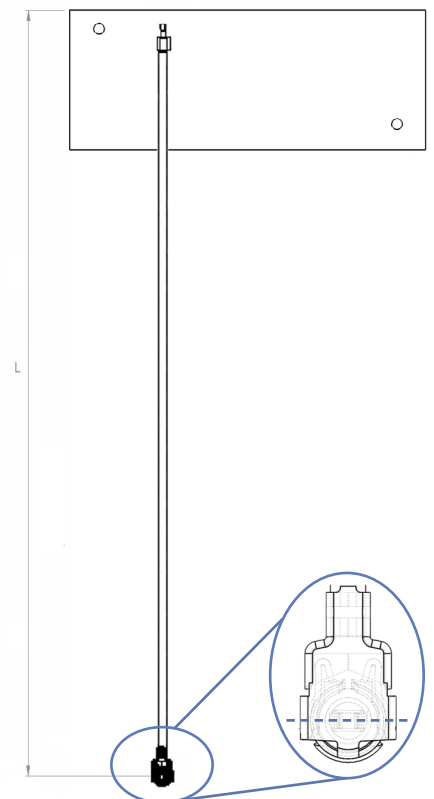

7.3. I-PEX connector MHF1 (20278-112R-13)

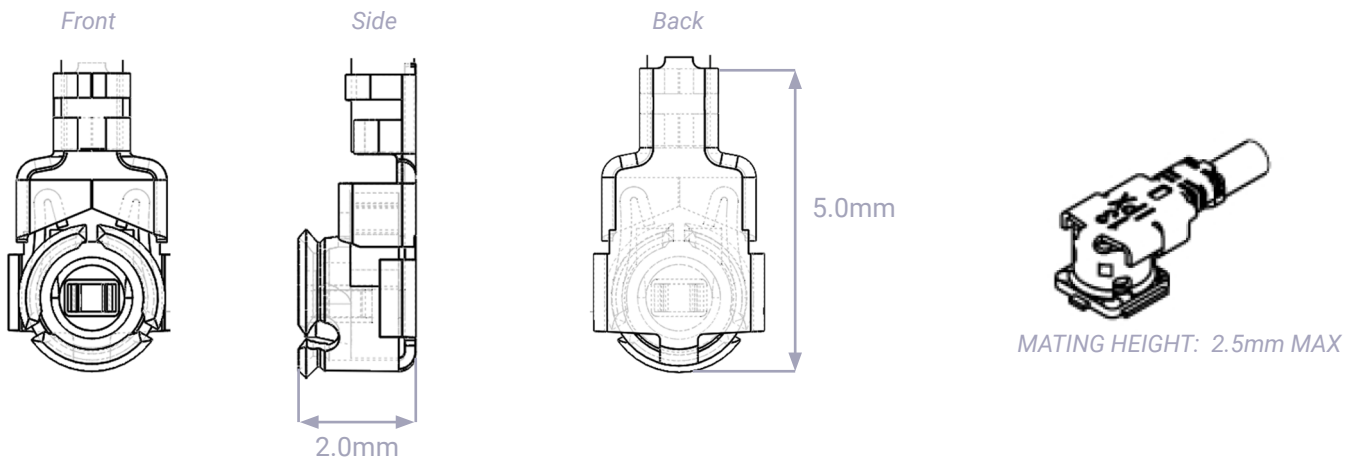

	I-PEX
MATERIAL	Copper Alloy
PLATING	Ag

All dimensions in (mm)

7.4. Assembly

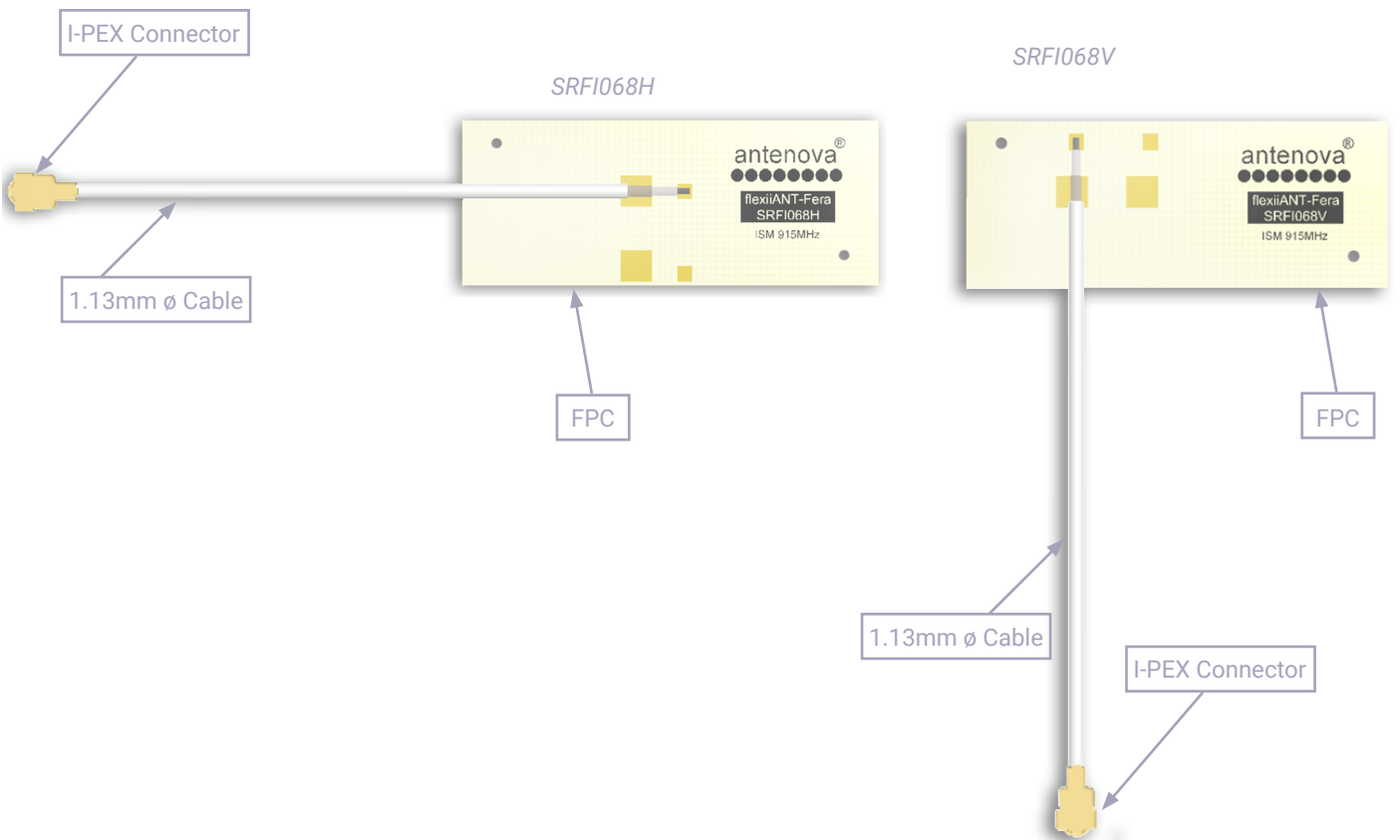

8. Electrical interface

8.1. Host interface

The host PCB requires the mating connector which is the I-PEX MHF (UFL) receptacle. The location should be close to the chip/modules pin for the RF. Any feed from this receptacle should be maintained at 50Ω impedance.

8.2. Transmission line

- Must have a characteristic impedance of 50Ω.
- Length should be kept to a minimum.
- Is recommended to be a co-planar waveguide: log on to [Antenova.com](https://www.antenova.com) and try our [Transmission line calculator](#) to easily calculate the dimensions most suited to your requirements.
- Should have DC blocking capacitor (e.g. 220pF) placed in line to protect the RF front end.

9. Mechanical fixing

The antenna uses 3M 468MP adhesive on the reverse side of the FPC. The antenna has an easy access split line to peel off to reveal the adhesive side. It is designed for a one time fix to a clean smooth surface. The antenna is keyed with two 1mm locating holes for easy positioning.

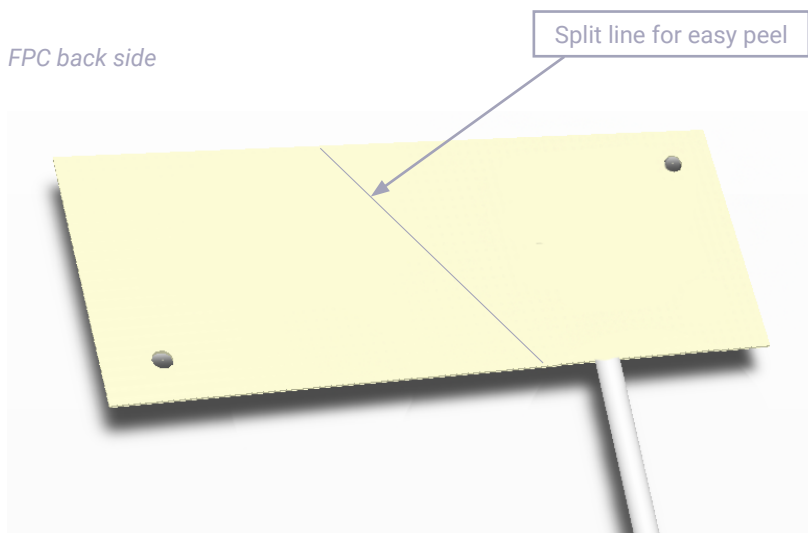

10. Antenna integration guide

We recommend the following during the design phase to maximise antenna performance and minimize noise:

- Minimum 4 layer PCB
- Route signals and power internally where possible
- Flood all layers with ground
- Knit ground on all layers together with plenty of vias

Follow placement guidance carefully, in addition Antenova provide technical support to help you through all stages of your design. Register for an account on <https://ask.antenova.com/> to access technical support.

10.1. Antenna placement

For FPC antennas the host PCB size is not critical to performance, however consideration must be given to placement. Using six spatial directions, as shown below, the antenna should ideally maintain a minimum of three directions free from obstruction in order to radiate effectively. Where there are obstructions (e.g. PCB, metal parts, battery etc.) a minimum clearance should still be maintained. These minimum clearances are described later in this section.

Six spatial directions relative to FPC

Example with 5 spatial directions clear

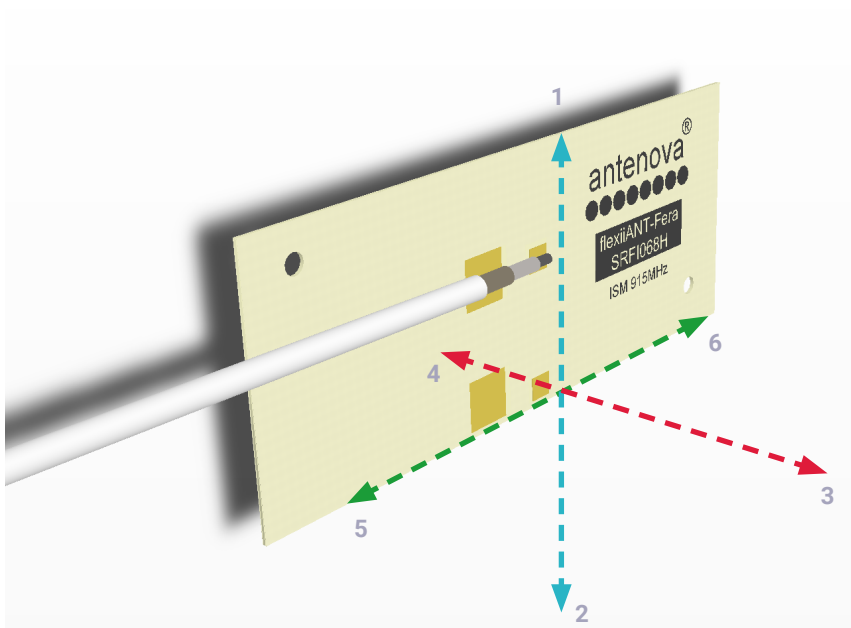

10.2. Orientation of FPC

The orientation of the FPC with respect to the host PCB should be defined depending on the unit. The proximity of the GND will have an influence on the antenna so the PCB location relative to the antenna should be considered.

The FPC will normally be placed in one of the three following options for orientation. In each option a distance (d) is the critical dimension to consider. The diagram below shows the minimum value of (d) for each. Other obstructions may increase this dimension.

Vertical mounted

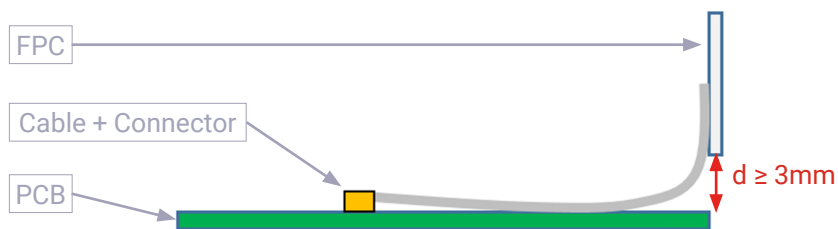

Co-planar to PCB

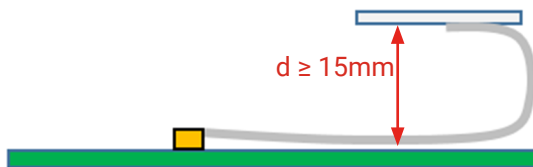

Planar to PCB (Same plane)



11. Hazardous material regulation conformance

The antenna has been tested to conform to RoHS and REACH requirements. A certificate of conformance is available from Antenova's website.

12. Packaging

The antennas are stored within an anti-static bag of 100 pcs.

100 units per bag (Labelled)

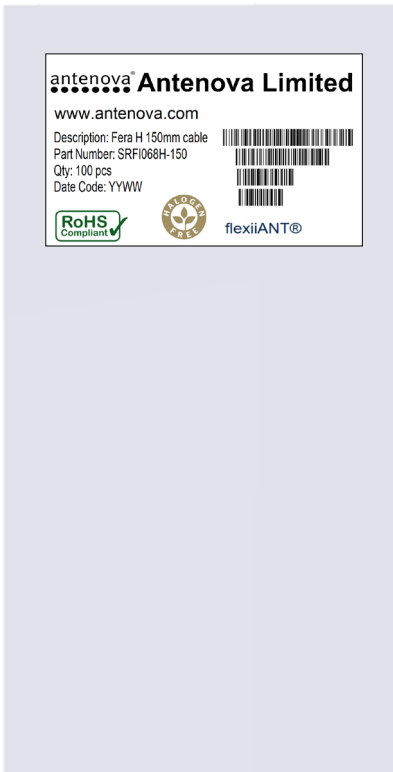

12.1. Optimal storage conditions

TEMPERATURE	-10°C to 40°C
HUMIDITY	Less than 75% RH
SHELF LIFE	18 Months
STORAGE PLACE	Away from corrosive gas and direct sunlight
PACKAGING	Antennas should be stored in unopened sealed manufacturer's plastic packaging.
MSL LEVEL	1

Note: The shelf life of the antenna is 18 months, provided the bag of 100 pieces remains factory- sealed.

12.2. Label information

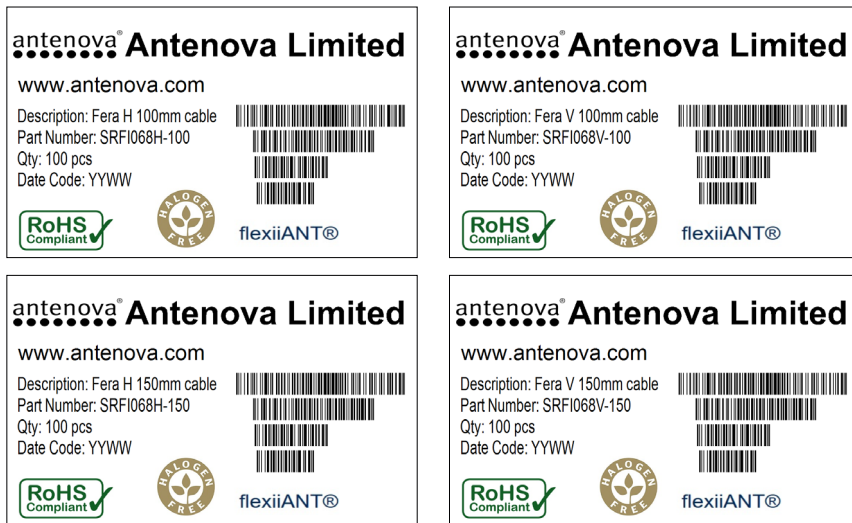

Quality statements

Antenova’s products conform to REACH and RoHS legislation. For our statements regarding these and other quality standards, please see antenova.com.



Antenova reserves all rights to the contents of this document. Antenova gives no warranties based solely on the accuracy or completeness of the contents of this document and reserves the right to make changes to the specifications of the products described herein at any time and without notice.