

Affini

SRFL064 • flexiANT[®]



Features

- Antenna for 3G, 4G and 5G cellular applications
- High performance with multiband coverage
- Supports Band 71 (617-698MHz) for 5G coverage in the USA
- High Efficiency within a small compact antenna
- Operates without requiring a ground plane on the product PCB

Contents

1.	Description	2
2.	Applications	2
3.	General data	2
4.	Part number	3
5.	RF characteristics	3
6.	RF performance	4
6.1.	Return loss	4
6.2.	VSWR	4
6.3.	Efficiency	5
6.4.	Antenna pattern	6
7.	Antenna dimensions	12
7.1.	Dimensions FPC section	12
7.2.	Dimensions assembled	12
7.3.	IPEX connector MHF1 (20278-112R-13)	13
7.4.	Assembly	13
8.	Electrical interface	14
8.1.	Host interface	14
8.2.	Transmission line	14
9.	Mechanical fixing	14
10.	Antenna integration guide	15
10.1.	Antenna placement	15
10.2.	Orientation of FPC	16
11.	Hazardous material regulation conformance	17
12.	Packaging	17
12.1.	Optimal storage conditions	18
12.2.	Label information	18

1. Description

A high efficiency FPC antenna that covers the most common 4G and 5G bands: B71 (617- 698MHz), LTE 700, GSM850, GSM900, DCS1800, PCS1900, WCDMA2100, LTE B40 (2300 – 2400MHz), LTE B7 (2500-2690MHz).

2. Applications

- Telematics and Remote monitoring
- IoT (Internet of Things)
- CCTV (Closed Circuit TV)
- Network devices such as cellular routers
- Pico base-stations
- POS (Point of Sale) terminals
- M2M (Machine to Machine)
- Drone communications

3. General data

FREQUENCY	617-698MHz 698-824MHz 824-960MHz 1710-2200MHz 2300-2400MHz 2500-2690MHz
POLARIZATION	Linear
OPERATING TEMPERATURE	-40°C to +85°C
ENVIRONMENTAL CONDITION TEST	ISO16750-4 5.1.1./5.1.2
IMPEDANCE	50 Ω
WEIGHT	<0.5g
ANTENNA TYPE	FPC Self-adhesive 3M 468MP
DIMENSIONS (ANTENNA)	78.0 x 17.0 x 0.15 (mm)
CONNECTION	I-PEX MHF1 (20278-112R-13)

4. Part number

AFFINI
SRFL064



5. RF characteristics

	617-698MHZ	698-824MHZ	824-960MHZ
PEAK GAIN	1.03dBi	1.03dBi	1.71dBi
AVERAGE GAIN (LINEAR)	-3.32dBi	-3.53dBi	-2.9dBi
AVERAGE EFFICIENCY	>45%	>45%	>50%
MAXIMUM RETURN LOSS	-5dB	-6dB	-8dB
MAXIMUM VSWR	3.1:1	2.7:1	2.2:1

	1710-2200MHZ	2300-2400MHZ	2500-2690MHZ
PEAK GAIN	3.86dBi	3.9dBi	3.88dBi
AVERAGE GAIN (LINEAR)	-2.12dBi	-1.58dBi	-1.93dBi
AVERAGE EFFICIENCY	>60%	>70%	>65%
MAXIMUM RETURN LOSS	-5dB	-12dB	-11dB
MAXIMUM VSWR	3.1:1	1.6:1	1.7:1

All data measured on SRFL064-150 in a loaded condition adhered to a plastic carrier in free space.

6. RF performance

6.1. Return loss

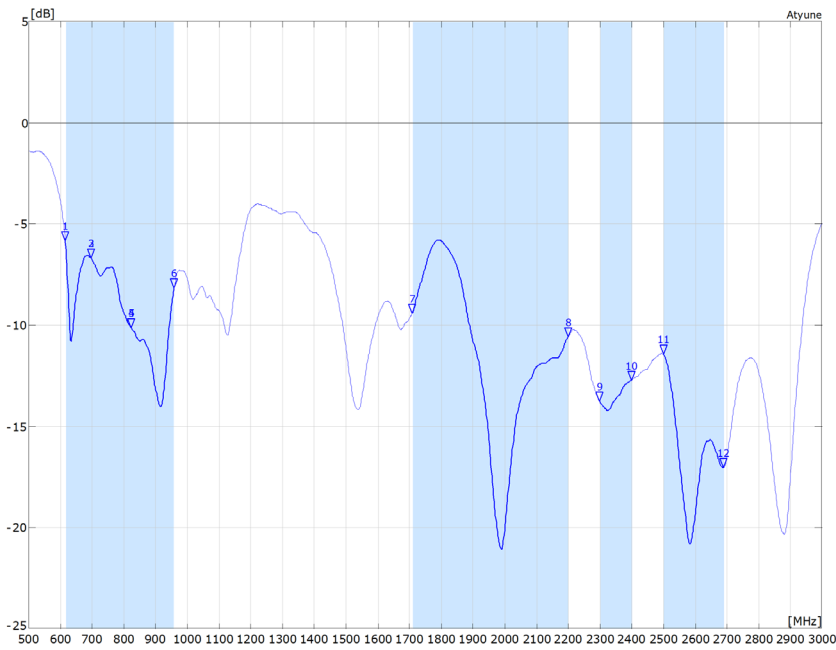

6.2. VSWR

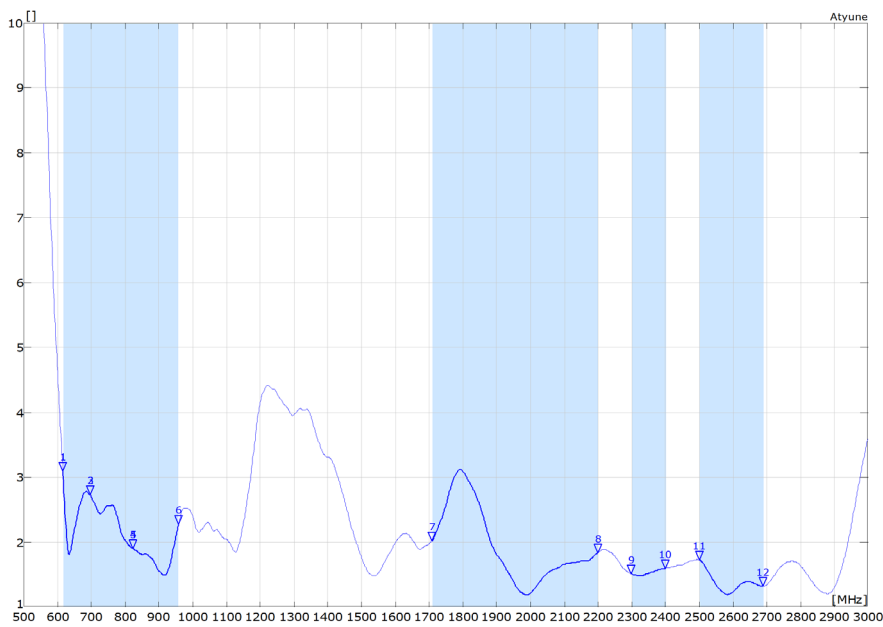

All data measured on SRFL064-150 in a loaded condition adhered to a plastic carrier in free space.

6.3. Efficiency

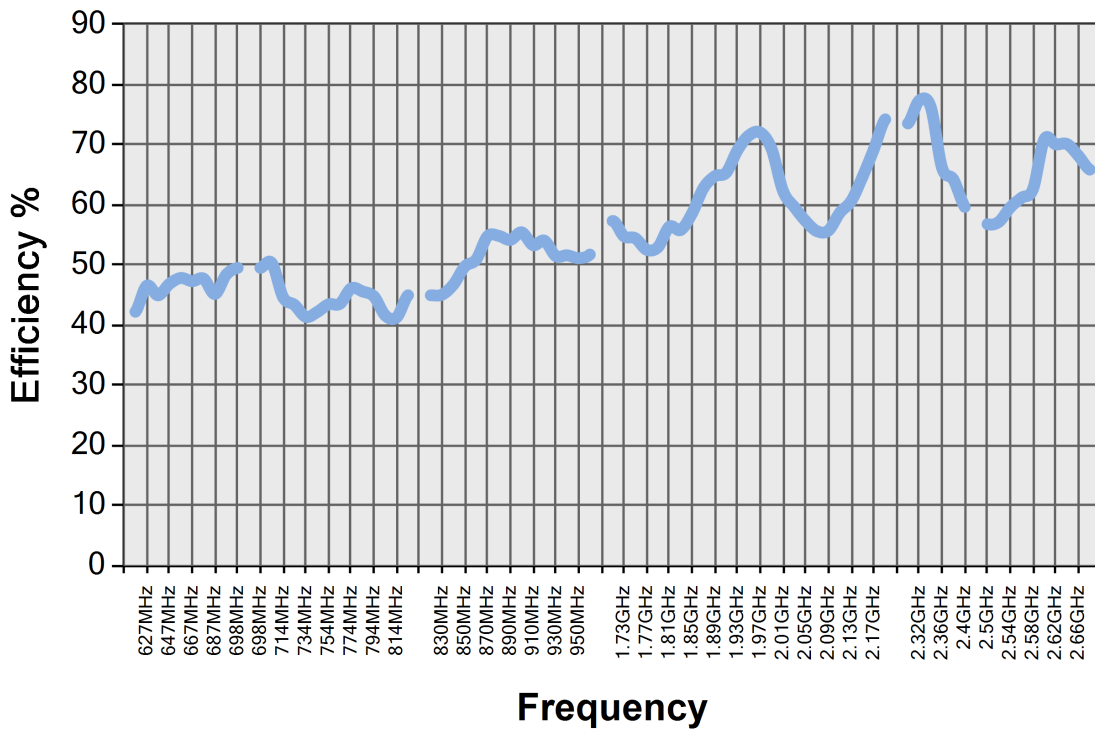

All data measured on SRFL064-150 in a loaded condition adhered to a plastic carrier in free space.

6.4. Antenna pattern

6.4.1. 617 MHz – 698 MHz

3D pattern at 657MHz

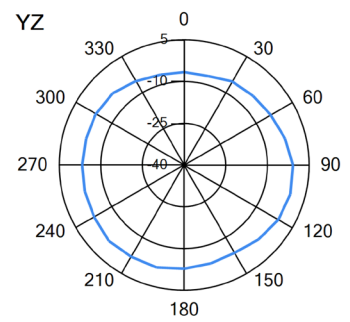
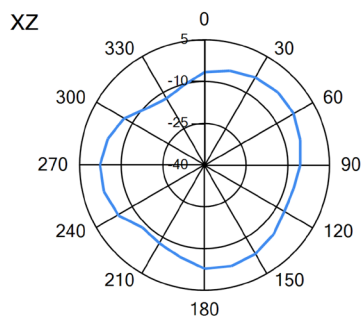
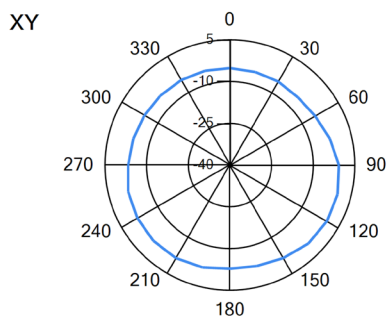
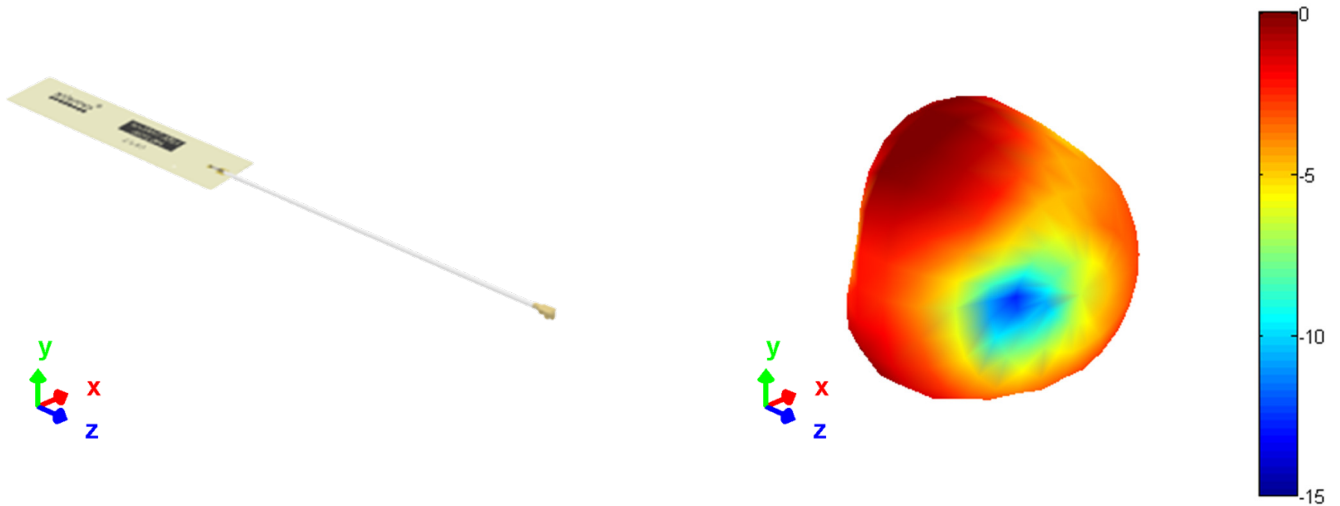

— 657MHz

6.4.2. 698 MHz – 824 MHz

3D pattern at 764MHz

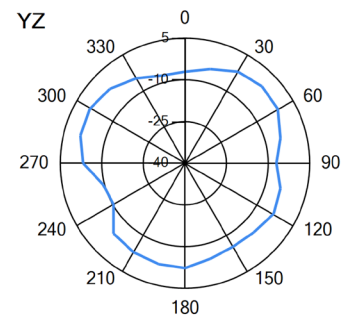
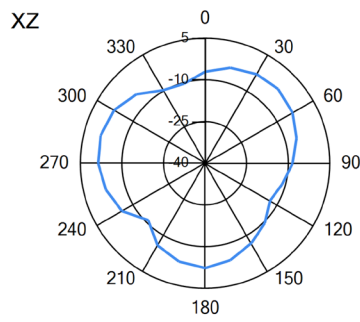
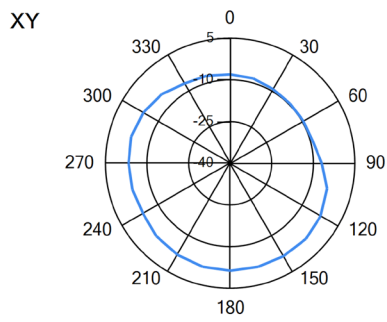
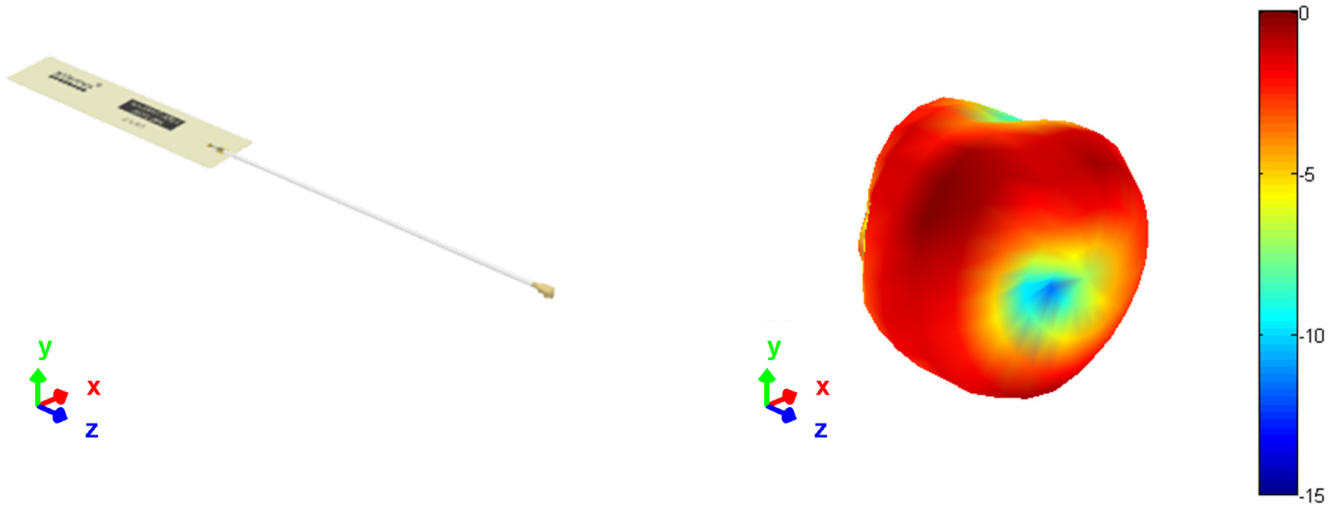

— 764MHz

6.4.3. 824 MHz – 960 MHz

3D pattern at 900MHz

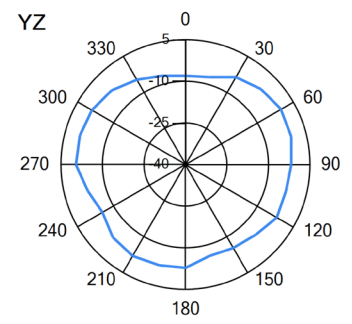
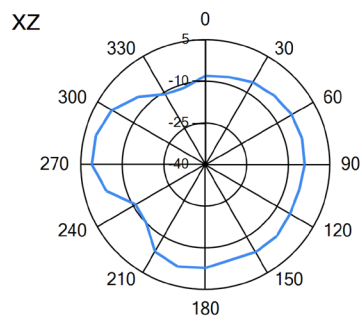
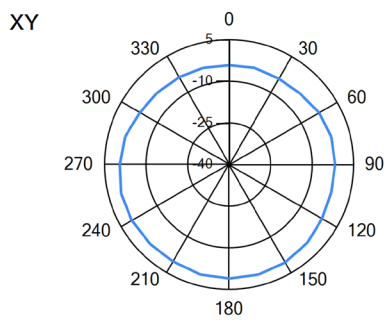
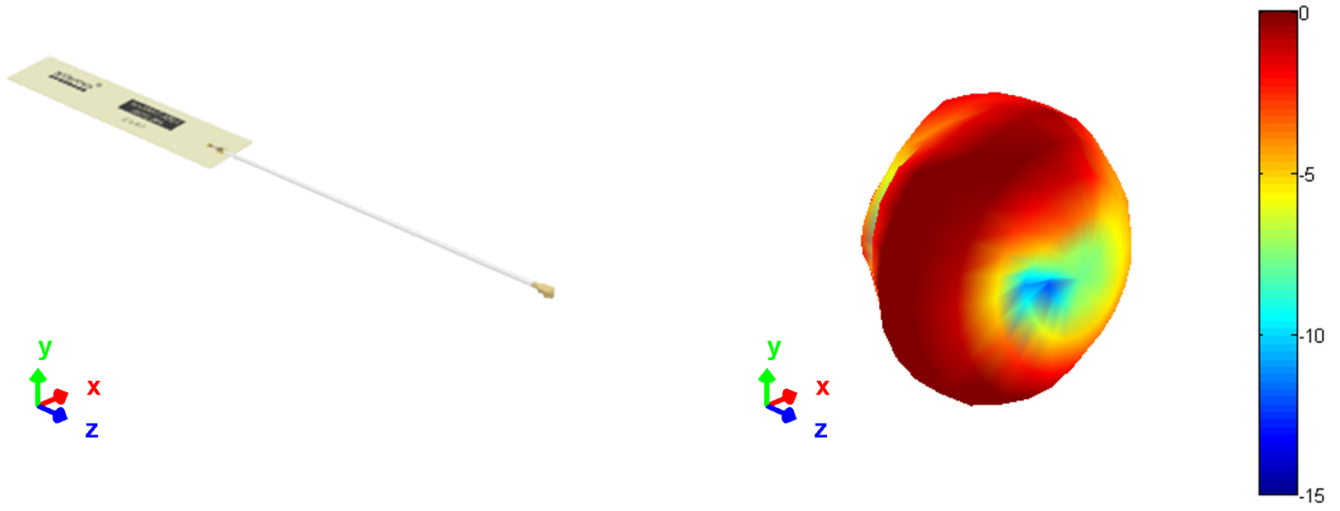

— 900MHz

6.4.4. 1710 MHz – 2200 MHz

3D pattern at 1930MHz

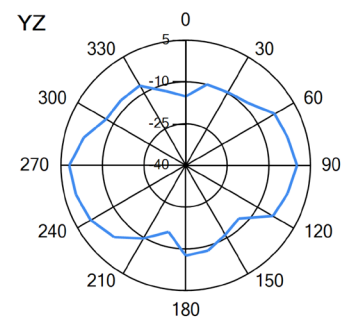
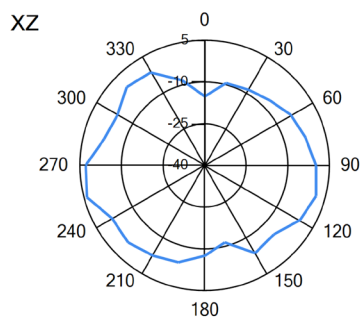
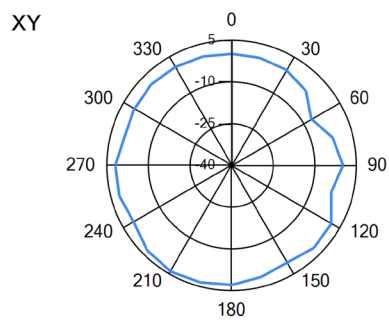
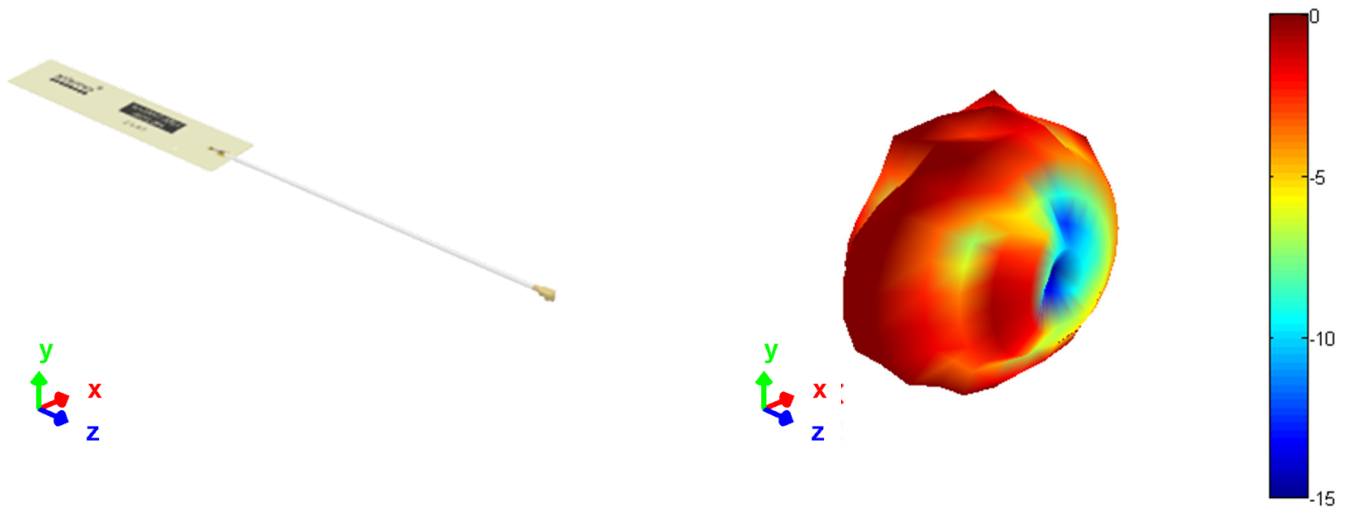

— 1.93GHz

6.4.5. 2300 MHz – 2400 MHz

3D pattern at 2340MHz

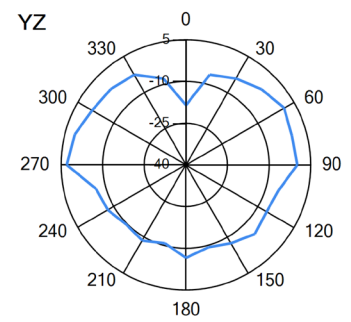
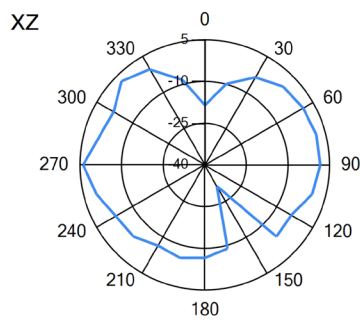
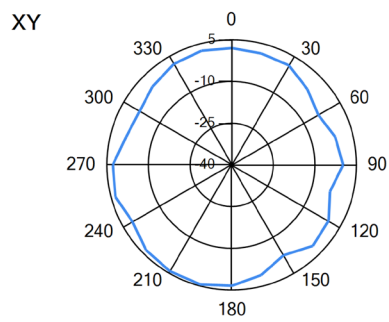
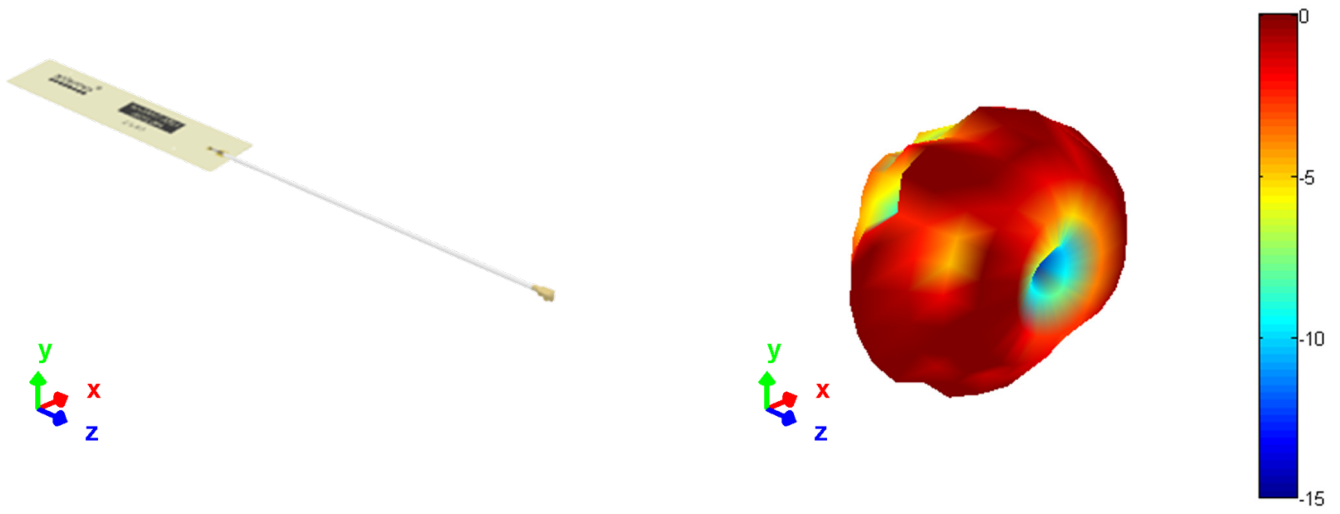

— 2.34GHz

6.4.6. 2500 MHz – 2690 MHz

3D pattern at 2600MHz

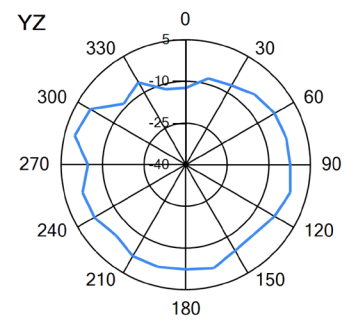
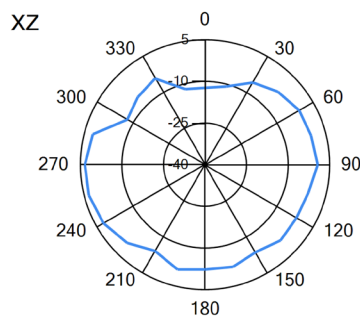
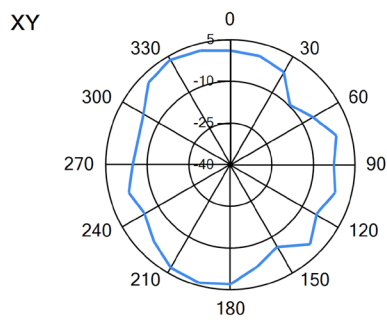
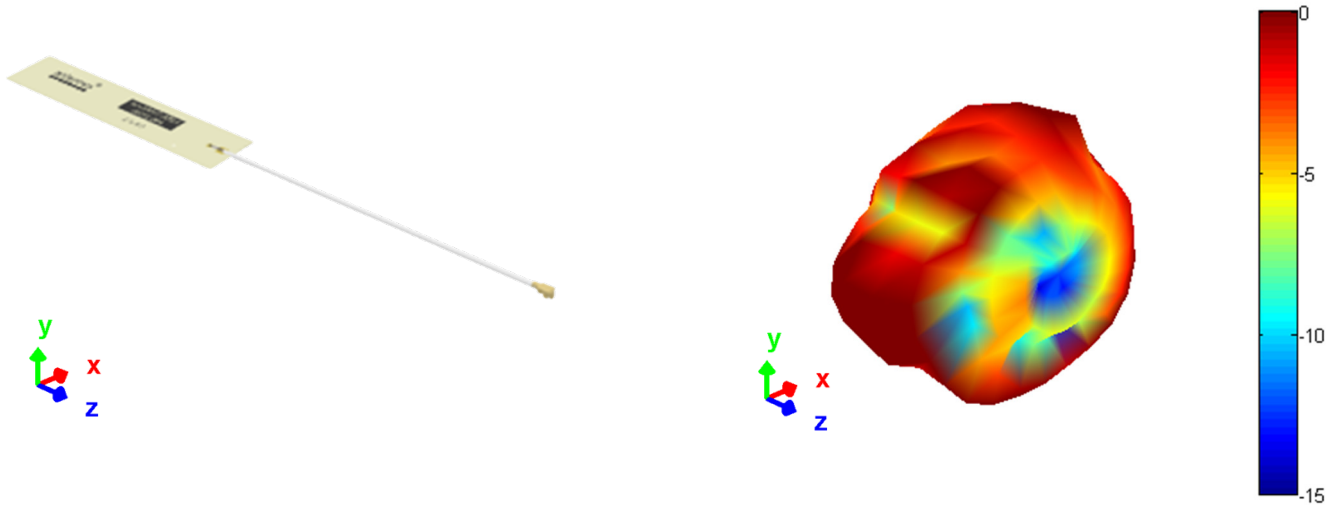

— 2.6GHz

7. Antenna dimensions

7.1. Dimensions FPC section

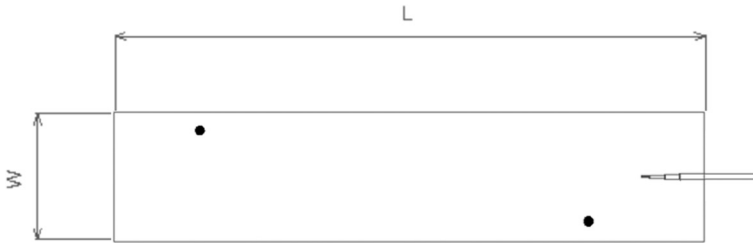

L	W	T
Length	Width	Thickness
78.0 ±0.2	17.0 ±0.2	0.15 (nominal)

All dimensions in (mm)

7.2. Dimensions assembled

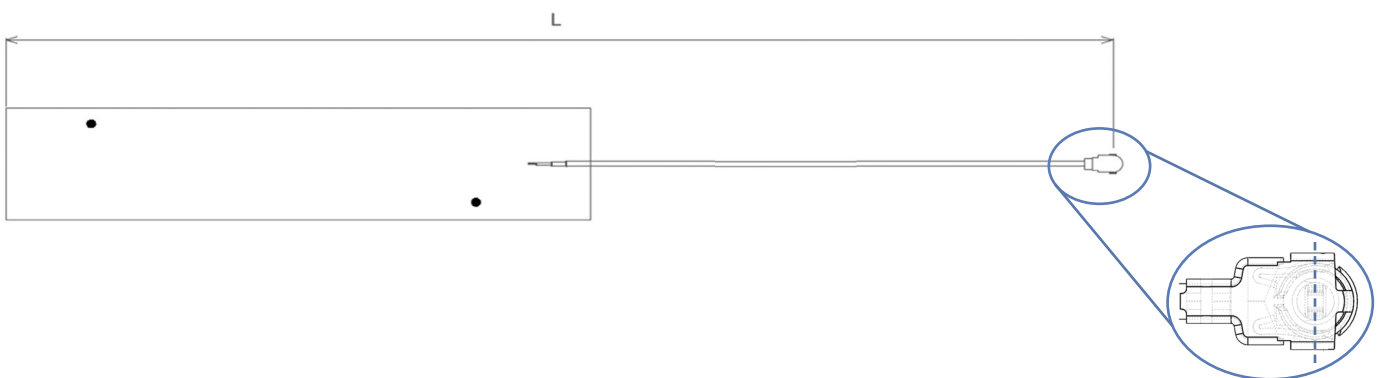

SRFL064-100	SRFL064-150
Length	Length
171 ±2.0	221 ±2.0

All dimensions in (mm)

Standard cable lengths for this antenna are 100mm and 150mm

7.3. I-PEX connector MHF1 (20278-112R-13)

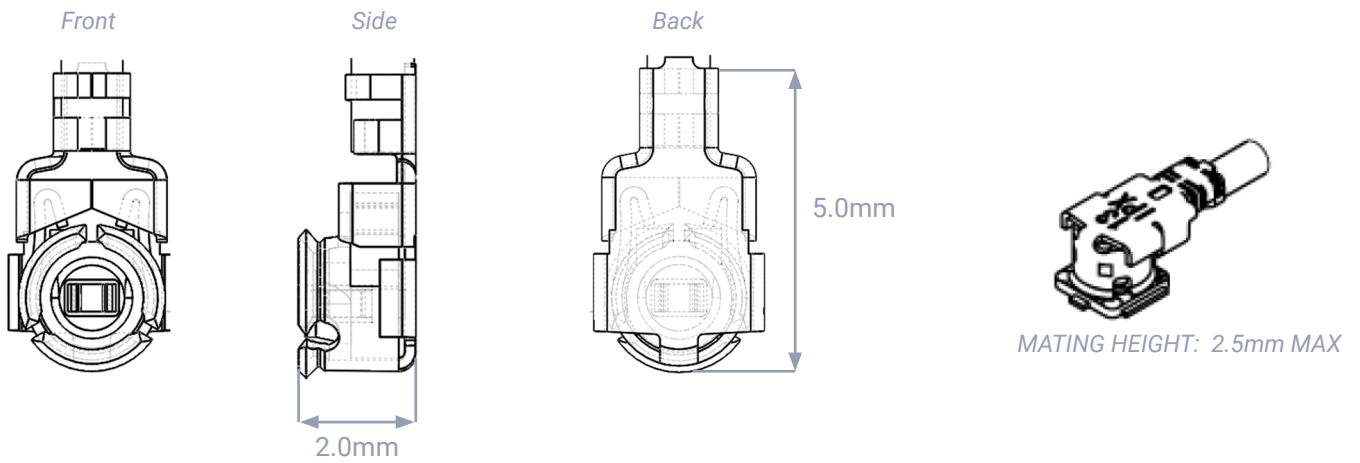

	I-PEX
MATERIAL	Copper Alloy
PLATING	Ag

All dimensions in (mm)

7.4. Assembly

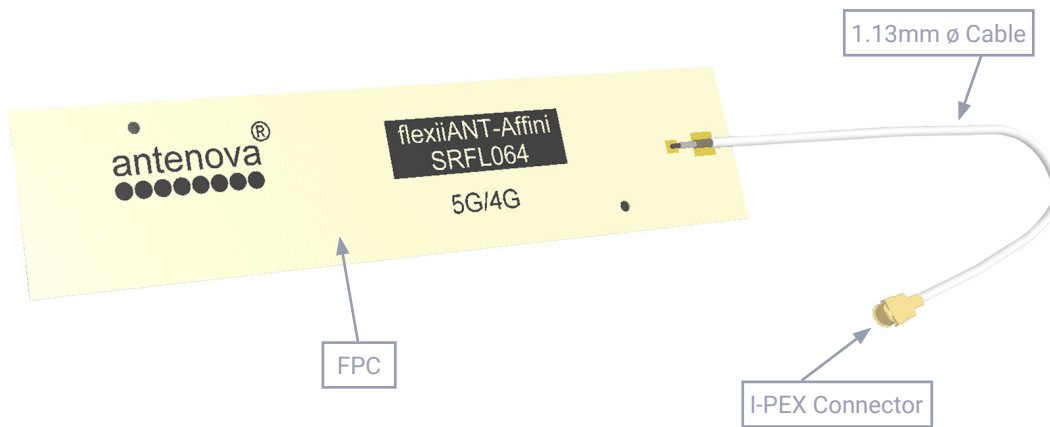

8. Electrical interface

8.1. Host interface

The host PCB requires the mating connector which is the I-PEX MHF (UFL) receptacle. The location should be close to the chip/modules pin for the RF. Any feed from this receptacle should be maintained at 50Ω impedance

8.2. Transmission line

- Must have a characteristic impedance of 50Ω.
- Length should be kept to a minimum.
- Is recommended to be a co-planar waveguide: log on to [Antenova.com](https://www.antenova.com) and try our [Transmission line calculator](#) to easily calculate the dimensions most suited to your requirements.
- Should have DC blocking capacitor (e.g. 220pF) placed in line to protect the RF front end.

9. Mechanical fixing

The antenna uses 3M 468MP adhesive on the reverse side of the FPC. The antenna has an easy access split line to peel off to reveal the adhesive side. It is designed for a one time fix to a clean smooth surface. The antenna is keyed with two 1mm locating holes for easy positioning.

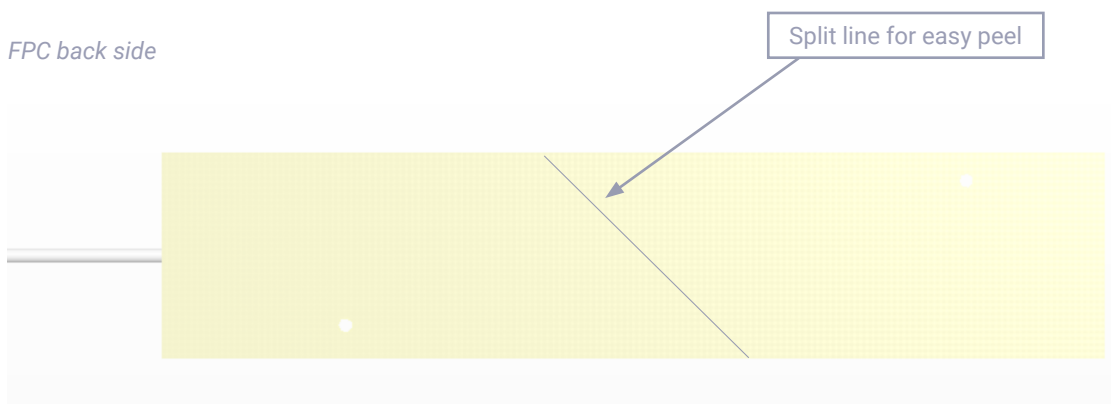

10. Antenna integration guide

We recommend the following during the design phase to maximise antenna performance and minimize noise:

- Minimum 4 layer PCB
- Route signals and power internally where possible
- Flood all layers with ground
- Knit ground on all layers together with plenty of vias

Follow placement guidance carefully, in addition Antenova provide technical support to help you through all stages of your design. Register for an account on <https://ask.antenova.com/> to access technical support.

10.1. Antenna placement

For FPC antennas the host PCB size is not critical to performance, however consideration must be given to placement. Using six spatial directions, as shown below, the antenna should ideally maintain a minimum of three directions free from obstruction in order to radiate effectively. Where there are obstructions (e.g. PCB, metal parts, battery etc.) a minimum clearance should still be maintained. These minimum clearances are described later in this section.

Six spatial directions relative to FPC

Example with 5 spatial directions clear

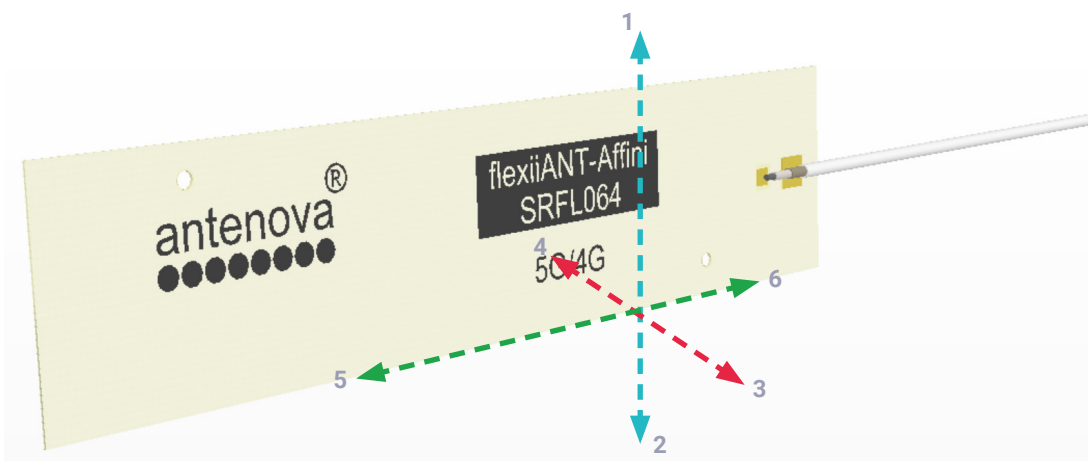

10.2. Orientation of FPC

The orientation of the FPC with respect to the host PCB should be defined depending on the unit. The proximity of the GND will have an influence on the antenna so the PCB location relative to the antenna should be considered.

The FPC will normally be placed in one of the three following options for orientation. In each option a distance (d) is the critical dimension to consider. The diagram below shows the minimum value of (d) for each. Other obstructions may increase this dimension.

Vertical mounted

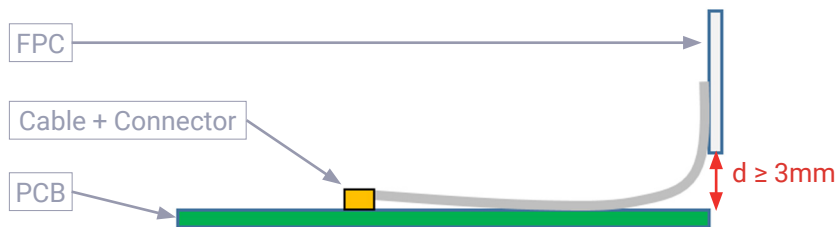

Co-planar to PCB

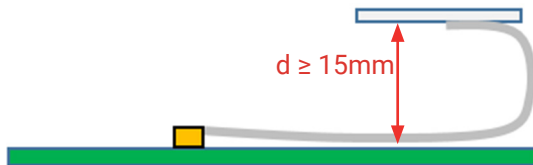

Planar to PCB (Same plane)



11. Hazardous material regulation conformance

The antenna has been tested to conform to RoHS and REACH requirements. A certificate of conformance is available from Antenova's website.

12. Packaging

The antennas are stored within a plastic bag of 100 pcs.

100 units per bag (Labelled)

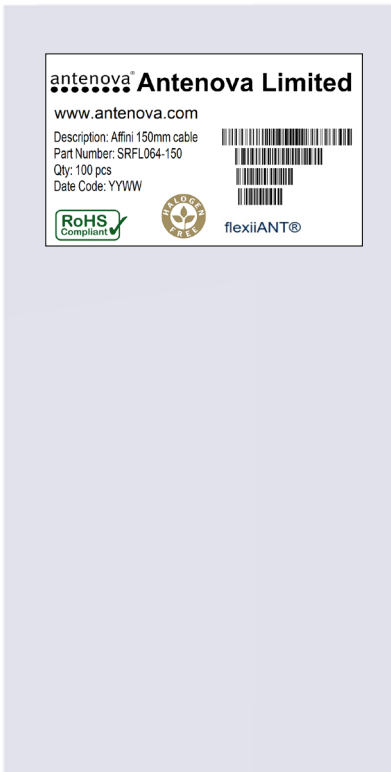

12.1. Optimal storage conditions

TEMPERATURE	-10°C to 40°C
HUMIDITY	Less than 75% RH
SHELF LIFE	18 Months
STORAGE PLACE	Away from corrosive gas and direct sunlight
PACKAGING	Antennas should be stored in unopened sealed manufacturer's plastic packaging.

Note: The shelf life of the antenna is 18 months, provided the bag of 100 pieces remains factory- sealed.

12.2. Label information



Quality statements

Antenova's products conform to REACH and RoHS legislation. For our statements regarding these and other quality standards, please see antenova.com.



Antenova reserves all rights to the contents of this document. Antenova gives no warranties based solely on the accuracy or completeness of the contents of this document and reserves the right to make changes to the specifications of the products described herein at any time and without notice.