

SRUK208x Series

RoHS

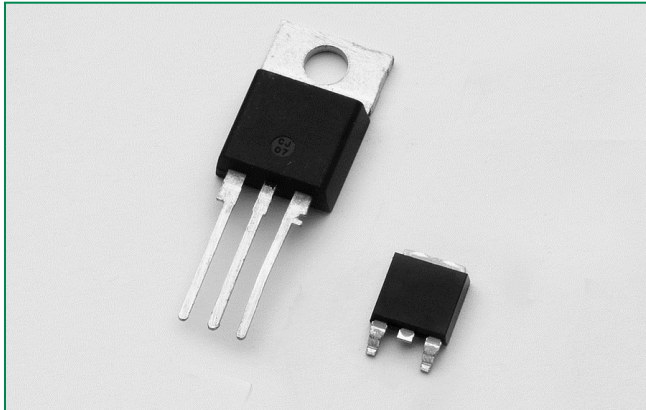

Description

The SRUK208x SCR series is specifically designed for high voltage capacitor discharge application

Features & Benefits

- High forward blocking voltage of 1200V
- High pulse current handling capability
- High di/dt of 350A/μs
- Reverse direction not design to function

Main Features

| Symbol | Value | Unit |
|--------------|-------|------|
| $I_{T(RMS)}$ | 8 | A |
| V_{DRM} | 1200 | V |
| V_{RRM} | N/A | V |
| I_{GT} | 15 | mA |

Applications

Typical applications are high voltage pulse generation by capacitor discharge for electric fences, CEWs (contact electric weapon) and high-power strobe lights.

Schematic Symbol

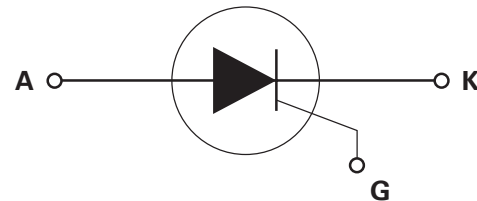

Absolute Maximum Ratings – Standard SCRs

| Symbol | Parameter | Test Conditions | Value | Unit |
|--------------|---|--|------------|------------------------|
| V_{DSM} | Non-repetitive peak off-state voltage | $T_J = 25^\circ\text{C}$ | 1400 | V |
| $I_{T(RMS)}$ | RMS on-state current | SRUK208R $T_C = 105^\circ\text{C}$ | 8 | A |
| $I_{T(AV)}$ | Average on-state current | SRUK208D $T_C = 110^\circ\text{C}$ | 5.1 | A |
| I_{TSM} | Peak non-repetitive surge current | single half cycle; $f = 50\text{Hz}$; T_J (initial) = 25°C | 83 | A |
| | | single half cycle; $f = 60\text{Hz}$; T_J (initial) = 25°C | 100 | |
| I_{TRM} | Peak Repetitive Pulse Current | Double-exponential, $1.7\mu\text{s} \times 7\mu\text{s}$, $f = 44\text{Hz}$, $T_A = 50^\circ\text{C}$ | 400 | A |
| I^2t | I^2t Value for fusing | $t_p = 8.3\text{ ms}$ | 41 | A^2s |
| di/dt | Critical rate-of-rise of on-state current | $T_J = 50^\circ\text{C}$ | 350 | $\text{A}/\mu\text{s}$ |
| I_{GM} | Peak gate current | $T_p = 10\mu\text{s}$, $T_J = 125^\circ\text{C}$ | 3 | A |
| $P_{G(AV)}$ | Average gate power dissipation | $T_J = 125^\circ\text{C}$ | 0.5 | W |
| T_{stg} | Storage temperature range | | -40 to 150 | $^\circ\text{C}$ |
| T_J | Operating junction temperature range | | -40 to 125 | $^\circ\text{C}$ |

Electrical Characteristics ($T_J = 25^\circ\text{C}$, unless otherwise specified)

| Symbol | Test Conditions | | Value | Unit |
|----------|---|------|-------|------------------|
| I_{GT} | $V_D = 12\text{V}$ $R_L = 60\ \Omega$ | MIN. | 5 | mA |
| | | MAX. | 15 | |
| V_{GT} | | MAX. | 1.5 | V |
| dv/dt | $V_D = V_{DRM}$; gate open; $T_J = 125^\circ\text{C}$ | MIN. | 100 | V/ μs |
| V_{GD} | $V_D = V_{DRM}$ $R_L = 3.3\ \text{k}\Omega$ $T_J = 125^\circ\text{C}$ | MIN. | 0.2 | V |
| I_H | $I_T = 200\text{mA}$ (initial) | MIN. | 10 | mA |
| | | MAX. | 30 | |
| t_q | $I_T=0.5\text{A}$; $t_p=50\mu\text{s}$; $dv/dt=5\text{V}/\mu\text{s}$; $di/dt=-30\text{A}/\mu\text{s}$ | TYP. | 40 | μs |
| t_{gt} | $I_G = 2 \times I_{GT}$ $\text{PW} = 15\mu\text{s}$ $I_T = 16\text{A}$ | TYP. | 1 | μs |

Static Characteristics

| Symbol | Test Conditions | | Value | Unit | |
|-----------|---|---------------------------|-------|------|---------------|
| V_{TM} | $I_T = 16\text{A}$; $t_p = 380\ \mu\text{s}$ | MAX. | 1.6 | V | |
| I_{DRM} | V_{DRM} | $T_J = 25^\circ\text{C}$ | MAX. | 10 | μA |
| | | $T_J = 125^\circ\text{C}$ | | 4 | mA |

Thermal Resistances

| Symbol | Parameter | | Value | Unit |
|-------------------|-----------------------|----------|-------|---------------------------|
| $R_{\theta(J-C)}$ | Junction to case (AC) | SRUK208R | 1.8 | $^\circ\text{C}/\text{W}$ |
| | | SRUK208D | 1.5 | |

Figure 1: Normalized DC Gate Trigger Current vs. Junction Temperature

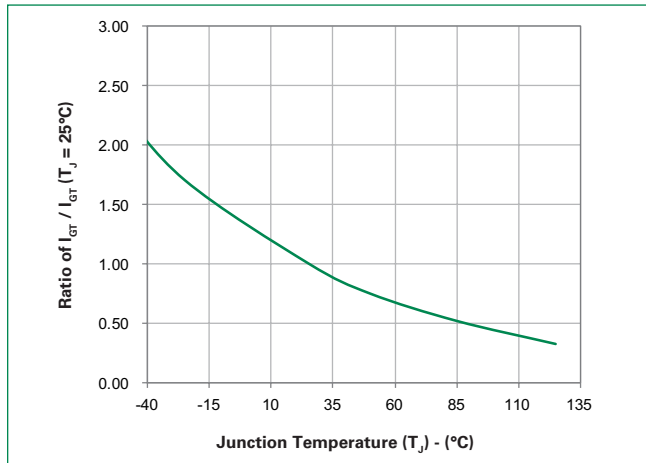

Figure 2: Normalized DC Gate Trigger Voltage vs. Junction Temperature

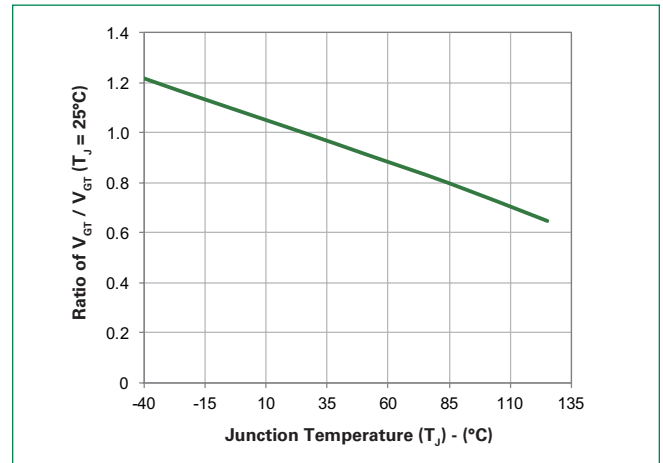

Figure 3: Normalized DC Holding Current vs. Junction Temperature

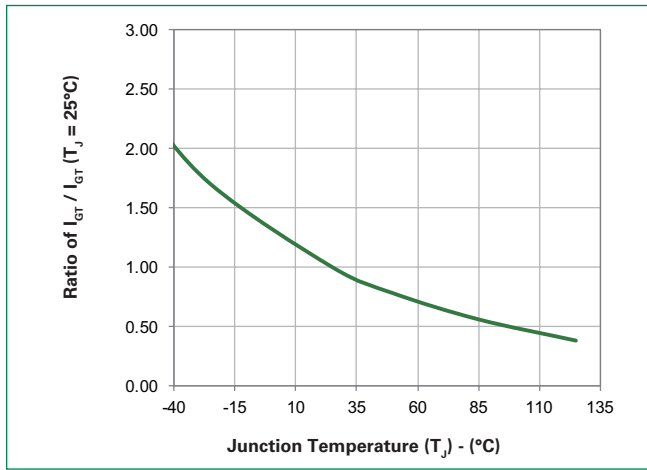

Figure 4: On-State Current vs. On-State Voltage (Typical)

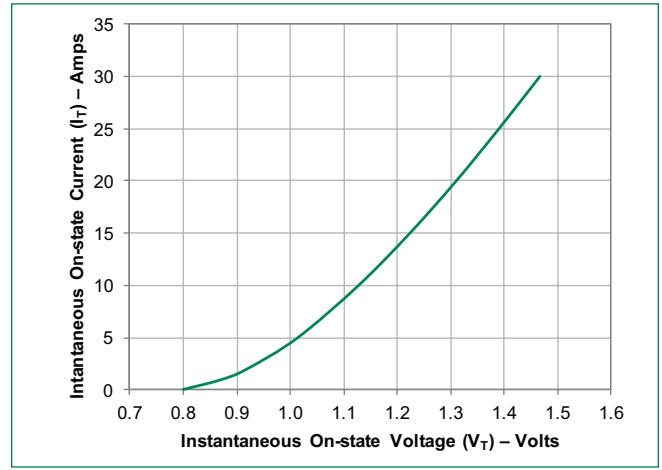

Figure 5: Power Dissipation (Typical) vs. RMS On-State Current

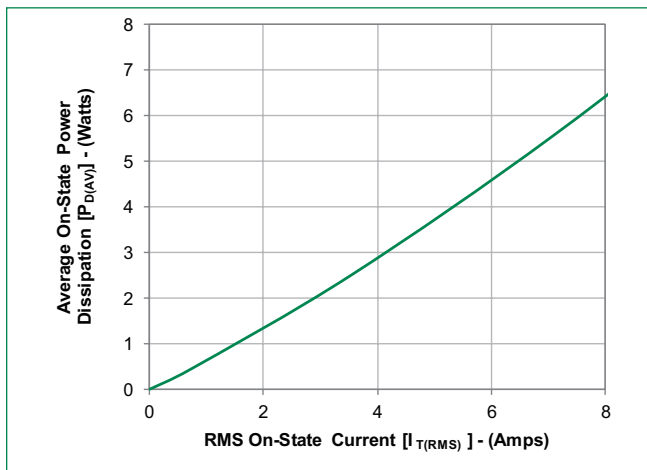

Figure 6: Maximum Allowable Case Temperature vs. RMS On-State Current

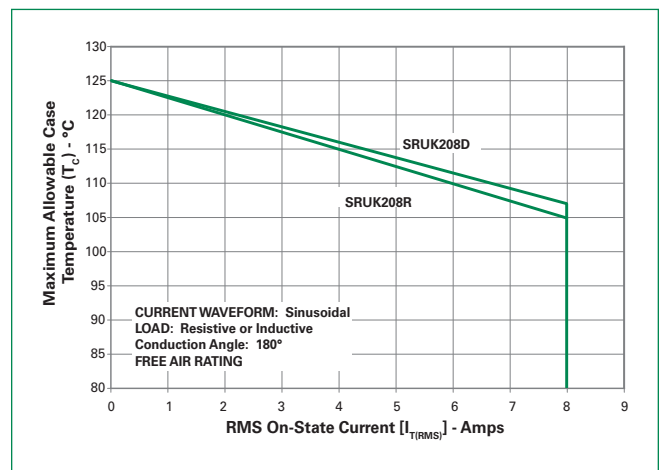

Figure 7: Maximum Allowable Case Temperature vs. Average On-State Current

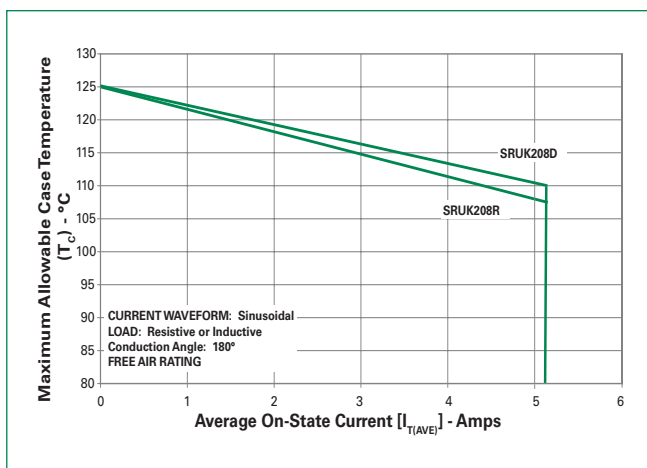

Figure 8: Peak Capacitor Discharge Current

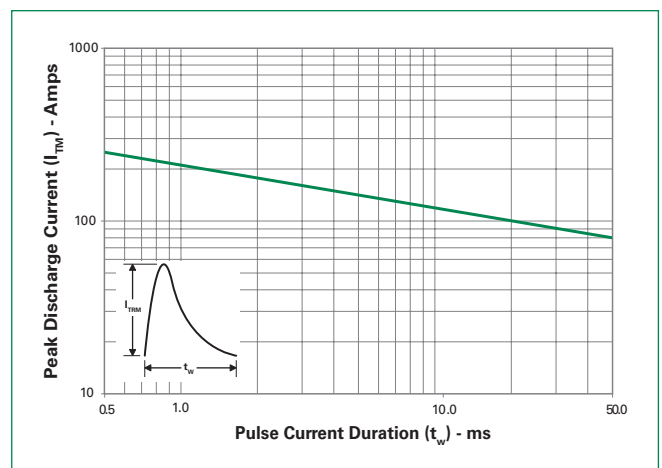

Figure 9: Peak Capacitor Discharge Current Derating

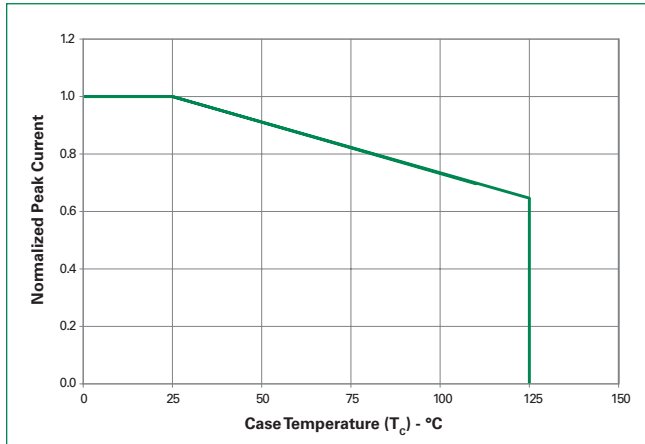
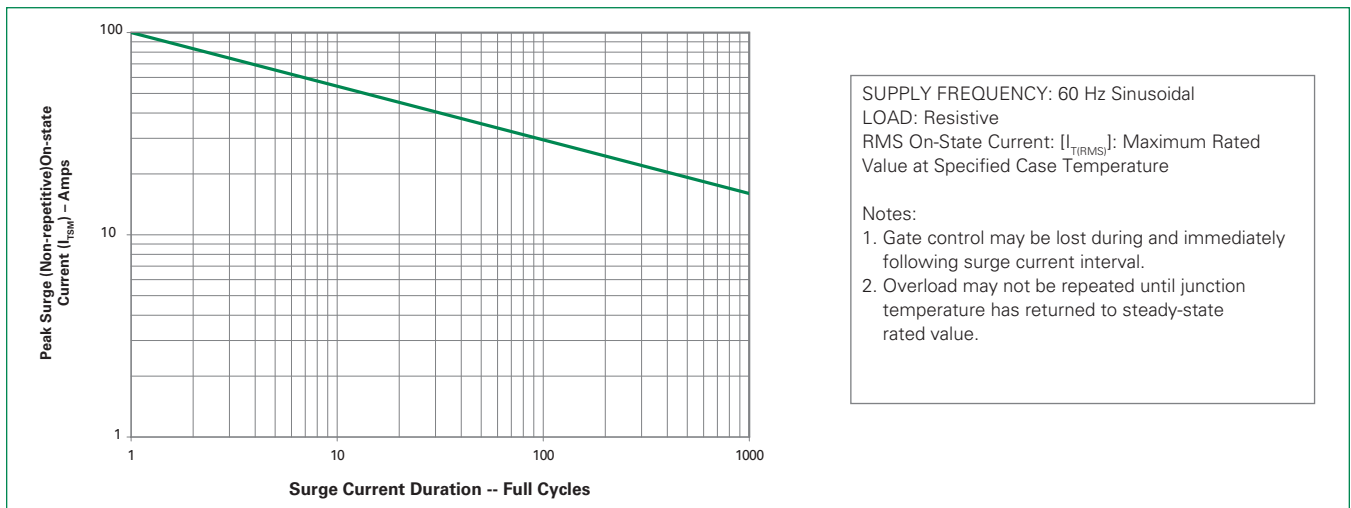
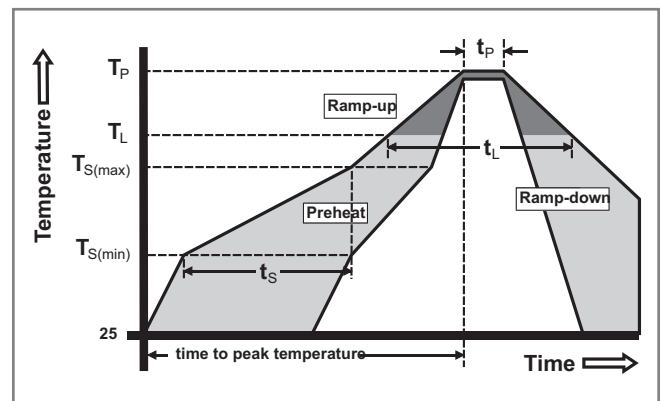

Figure 10: Surge Peak On-State Current vs. Number of Cycles



Soldering Parameters

| | | |
|--|------------------------------------|------------------|
| Reflow Condition | Pb – Free assembly | |
| Pre Heat | - Temperature Min ($T_{s(min)}$) | 150°C |
| | - Temperature Max ($T_{s(max)}$) | 200°C |
| | - Time (min to max) (t_s) | 60 – 180 secs |
| Average ramp up rate (Liquidus Temp (T_L) to peak) | 5°C/second max | |
| $T_{s(max)}$ to T_L - Ramp-up Rate | 5°C/second max | |
| Reflow | - Temperature (T_L) (Liquidus) | 217°C |
| | - Time (t_L) | 60 – 150 seconds |
| Peak Temperature (T_p) | 260 ^{+0/-5} °C | |
| Time within 5°C of actual peak Temperature (t_p) | 20 – 40 seconds | |
| Ramp-down Rate | 5°C/second max | |
| Time 25°C to peak Temperature (T_p) | 8 minutes Max. | |
| Do not exceed | 280°C | |



Physical Specifications

| | |
|------------------------|---|
| Terminal Finish | 100% Matte Tin-plated |
| Body Material | UL Recognized epoxy meeting flammability rating V-0 |
| Lead Material | Copper Alloy |

Design Considerations

Careful selection of the correct component for the application's operating parameters and environment will go a long way toward extending the operating life of the Thyristor. Good design practice should limit the maximum continuous current through the main terminals to 75% of the component rating. Other ways to ensure long life for a power discrete semiconductor are proper heat sinking and selection of voltage ratings for worst case conditions. Overheating, overvoltage (including dv/dt), and surge currents are the main killers of semiconductors. Correct mounting, soldering, and forming of the leads also help protect against component damage.

Environmental Specifications

| Test | Specifications and Conditions |
|----------------------------------|---|
| AC Blocking | Rectified Peak AC voltage@125°C for 96 hours |
| DC Blocking | 96hours; DC 1200V@85°C |
| Temperature/Humidity | 96hours; 320V –DC; 85°C 85% rel humidity |
| Temperature Cycling | 100cycles; -40°C to +125°C; 15-min dwell-time |
| Resistance to Solder Heat | MIL-STD-750 Method 2031 |
| Solderability | ANSI/J-STD-002, category 3, Test A |

Dimensions — TO-220AB (R-Package) — Non-Isolated Mounting Tab Common with Center Lead

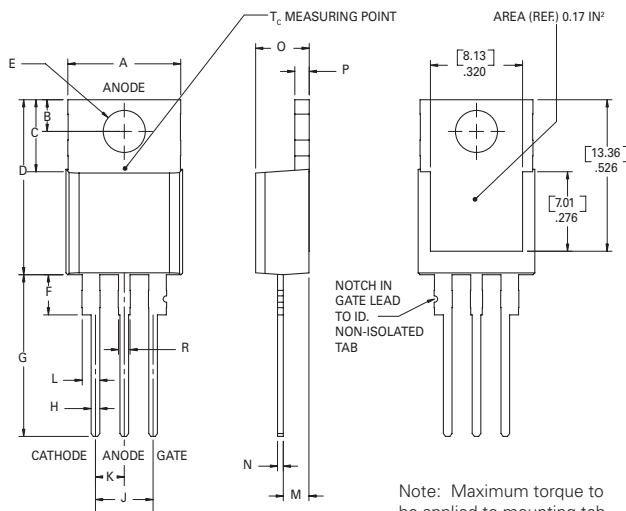

| Dimension | Inches | | Millimeters | |
|-----------|--------|-------|-------------|-------|
| | Min | Max | Min | Max |
| A | 0.380 | 0.420 | 9.65 | 10.67 |
| B | 0.105 | 0.115 | 2.67 | 2.92 |
| C | 0.230 | 0.250 | 5.84 | 6.35 |
| D | 0.590 | 0.620 | 14.99 | 15.75 |
| E | 0.142 | 0.147 | 3.61 | 3.73 |
| F | 0.110 | 0.130 | 2.79 | 3.30 |
| G | 0.540 | 0.575 | 13.72 | 14.61 |
| H | 0.025 | 0.035 | 0.64 | 0.89 |
| J | 0.195 | 0.205 | 4.95 | 5.21 |
| K | 0.095 | 0.105 | 2.41 | 2.67 |
| L | 0.060 | 0.075 | 1.52 | 1.91 |
| M | 0.085 | 0.095 | 2.16 | 2.41 |
| N | 0.018 | 0.024 | 0.46 | 0.61 |
| O | 0.178 | 0.188 | 4.52 | 4.78 |
| P | 0.045 | 0.060 | 1.14 | 1.52 |
| R | 0.038 | 0.048 | 0.97 | 1.22 |

Dimensions — TO-252AA (D-Package) — D-PAK Surface Mount

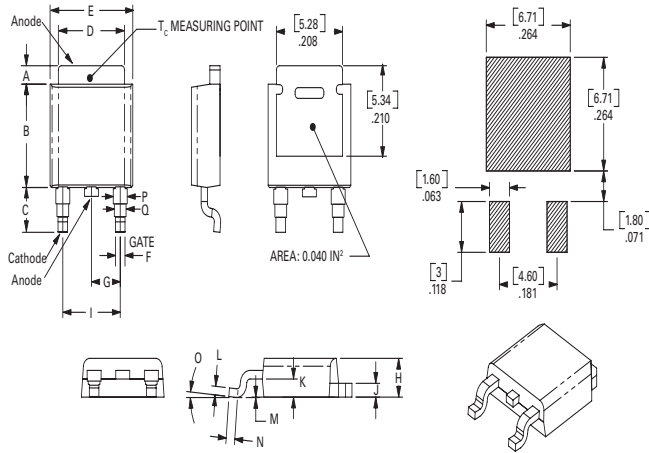

| Dimension | Inches | | | Millimeters | | |
|-----------|--------|-------|-------|-------------|------|------|
| | Min | Typ | Max | Min | Typ | Max |
| A | 0.037 | 0.040 | 0.043 | 0.94 | 1.01 | 1.09 |
| B | 0.235 | 0.243 | 0.245 | 5.97 | 6.16 | 6.22 |
| C | 0.106 | 0.108 | 0.113 | 2.69 | 2.74 | 2.87 |
| D | 0.205 | 0.208 | 0.213 | 5.21 | 5.29 | 5.41 |
| E | 0.255 | 0.262 | 0.265 | 6.48 | 6.65 | 6.73 |
| F | 0.027 | 0.031 | 0.033 | 0.69 | 0.80 | 0.84 |
| G | 0.087 | 0.090 | 0.093 | 2.21 | 2.28 | 2.36 |
| H | 0.085 | 0.092 | 0.095 | 2.16 | 2.33 | 2.41 |
| I | 0.176 | 0.179 | 0.184 | 4.47 | 4.55 | 4.67 |
| J | 0.018 | 0.020 | 0.023 | 0.46 | 0.51 | 0.58 |
| K | 0.035 | 0.037 | 0.039 | 0.90 | 0.95 | 1.00 |
| L | 0.018 | 0.020 | 0.023 | 0.46 | 0.51 | 0.58 |
| M | 0.000 | 0.000 | 0.004 | 0.00 | 0.00 | 0.10 |
| N | 0.021 | 0.026 | 0.027 | 0.53 | 0.67 | 0.69 |
| O | 0° | 0° | 5° | 0° | 0° | 5° |
| P | 0.042 | 0.047 | 0.052 | 1.06 | 1.20 | 1.32 |
| Q | 0.034 | 0.039 | 0.044 | 0.86 | 1.00 | 1.11 |

Packing Options

| Part Number | Marking | Package | Type | Weight | Packing Mode | Base Quantity |
|-------------|----------|---------|--------------|--------|------------------|---------------|
| SRUK208RTP | SRUK208R | TO-220R | Standard SCR | 2.2 g | Tube | 500 |
| SRUK208DRP | SRUK208D | TO-252 | Standard SCR | 0.3 g | Embossed Carrier | 2500 |

Part Numbering System

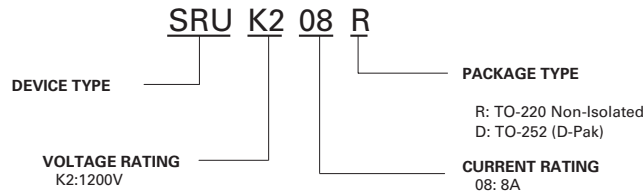

Part Marking System

TO-220 AB - (R Package) TO-252AA - (D Package)

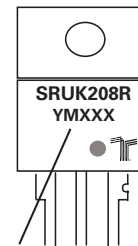

Date Code Marking
Y: Year Code
M: Month Code
XXX: Lot Trace Code

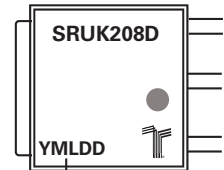

Date Code Marking
Y: Year Code
M: Month Code
L: Location Code
DD: Calendar Code