

**SURFACE MOUNT SCHOTTKY
BARRIER RECTIFIER**
VOLTAGE RANGE 20 to 100 Volts CURRENT 1.0 Ampere

FEATURES

- * Low power loss, high efficiency
- * Low leakage
- * Low forward voltage drop
- * High current capability
- * High speed switching
- * High surge capability
- * High reliability
- * Guard ring construction on dice
- * ESD: HBM class 3B ,MM class M4
- * P/N suffix V means AEC-Q101 qualified, e.g:SS20V
- * P/N suffix V means Halogen-free

MECHANICAL DATA

- * Epoxy: Device has UL flammability classification 94V-0
- * Mounting position: Any
- * Weight:0.018gram (Approx.)
- * Flat lead frame

MAXIMUM RATINGS AND ELECTRICAL CHARACTERISTICS

Ratings at 25 °C ambient temperature unless otherwise specified.
Resistive or inductive load.

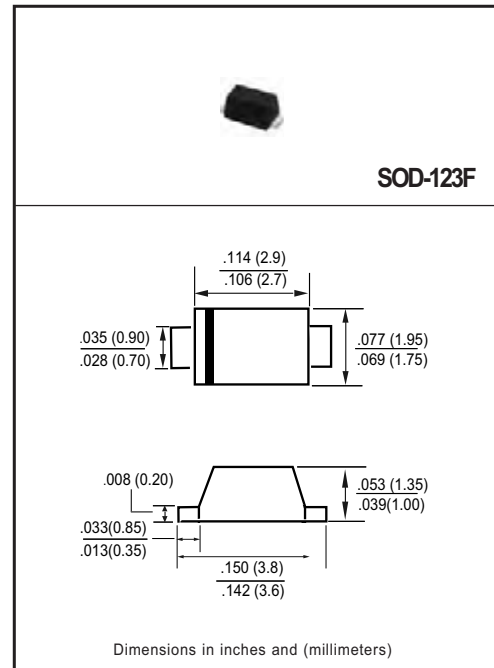

MAXIMUM RATINGS (@ TA=25 °C unless otherwise noted)

RATINGS	SYMBOL	SS20	SS30	SS40	SS50	SS60	SS80	SS100	UNITS
Maximum Recurrent Peak Reverse Voltage	V _{RRM}	20	30	40	50	60	80	100	Volts
Maximum RMS Voltage	V _{RMS}	14	21	28	35	42	56	70	Volts
Maximum DC Blocking Voltage	V _{DC}	20	30	40	50	60	80	100	Volts
Maximum Average Forward Rectified Current @ TA=75 °C	I _O	1.0							Amps
Peak Forward Surge Current 8.3 ms single half sine-wave superimposed on rated load (JEDEC method)	I _{FSM}	40							Amps
Typical Current Square Time	I ² T	6.6							A ² S
Typical Thermal Resistance (Note 3)	R _{θJA}	110							°C/W
	R _{θJL}	30							
Operating Temperature Range	T _J	-55 to + 150							°C
Storage Temperature Range	T _{STG}	-55 to + 150							°C
Total Capacitance (Note 1)	C _T	75							pF

ELECTRICAL CHARACTERISTICS(@TA=25 °C unless otherwise noted)

CHARACTERISTICS	SYMBOL	SS20	SS30	SS40	SS50	SS60	SS80	SS100	UNITS
Maximum Instantaneous Forward Voltage at 1.0A DC	V _F	0.55			0.70		0.85		Volts
Maximum Average Reverse Current at Rated DC Blocking Voltage	@TA = 25°C	0.2							mAmps
	@TA =150 °C	5							mAmps

- NOTES : 1. Measured at 1 MHz and applied reverse voltage of 4 Volts.
2."ROHS compliant"
3. Thermal Resistance: Mounted on PCB.

RATING AND CHARACTERISTICS CURVES (SS20 THRU SS100)

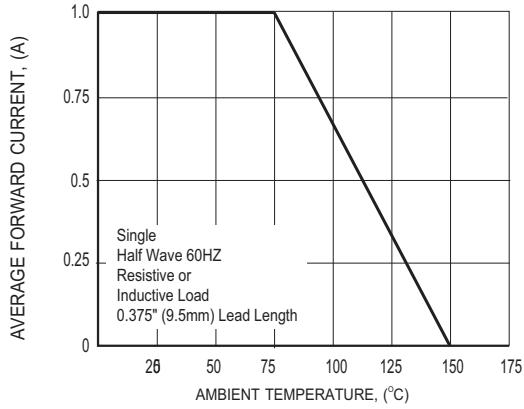

FIG.1 TYPICAL FORWARD CURRENT DERATING CURVE

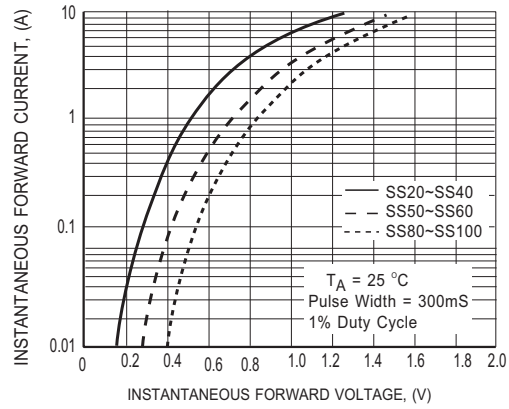

FIG.2 MAXIMUM INSTANTANEOUS FORWARD CHARACTERISTICS

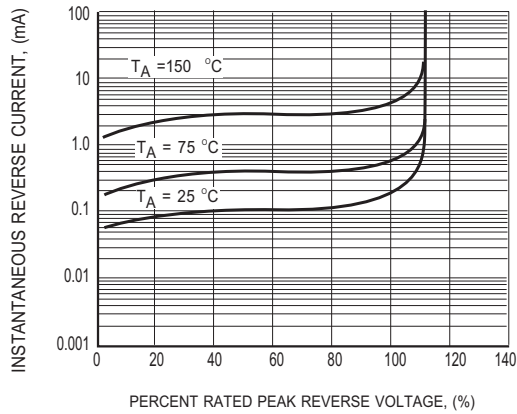

FIG.3 MAXIMUM REVERSE CHARACTERISTICS

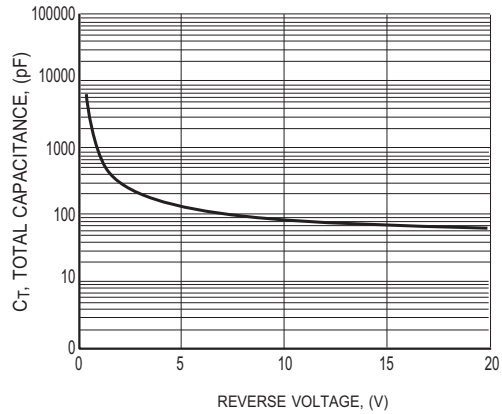

FIG.4 TYPICAL TOTAL CAPACITANCE

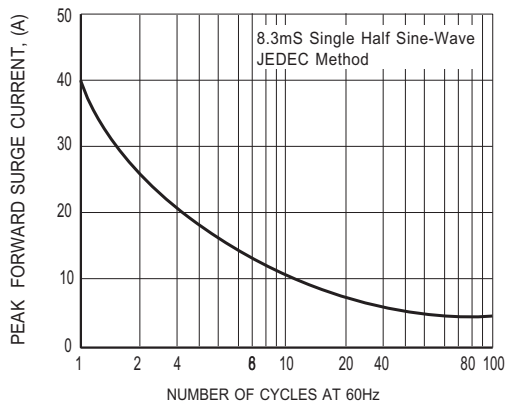
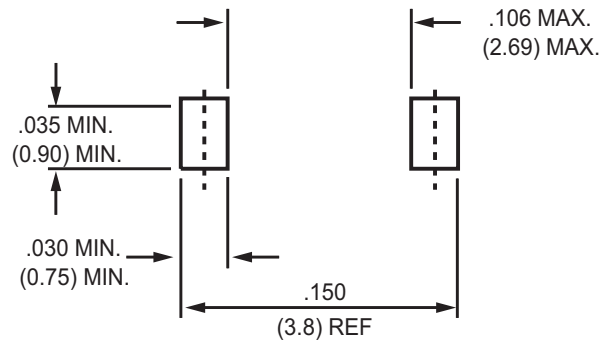

FIG.5 TYPICAL REVERSE CHARACTERISTICS

Mounting Pad Layout



Dimensions in inches and (millimeters)

Marking Description

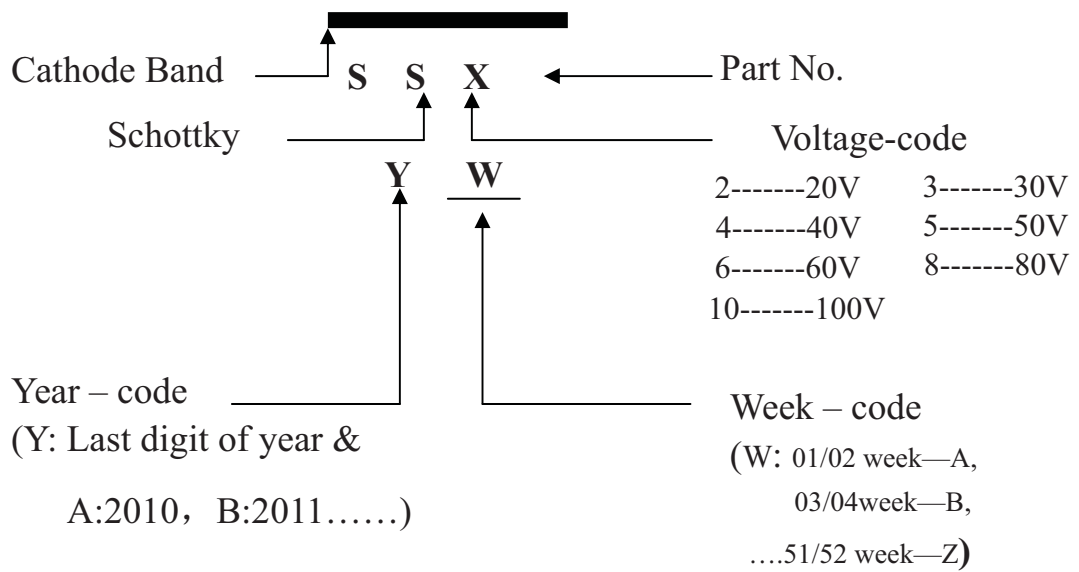

PACKAGING OF DIODE AND BRIDGE RECTIFIERS

REEL PACK

PACKAGE	PACKING CODE	EA PER REEL	EA PER INNER BOX	COMPONENT SPACE (mm)	TAPE SPACE (mm)	REEL DIA (mm)	CARTON SIZE (mm)	EA PER CARTON	GROSS WEIGHT(Kg)
SOD-123F/ SOD-123FL	-W	3,000	15,000	---	---	178	390*205*31	120,000	6.964