

1A, 40V - 200V Schottky Barrier Surface Mount Rectifier

FEATURES

- AEC-Q101 qualified
- Low power loss, high efficiency
- Ideal for automated placement
- High surge current capability
- Moisture sensitivity level: level 1, per J-STD-020
- RoHS Compliant
- Halogen-free according to IEC 61249-2-21

APPLICATIONS

- Switching mode power supply (SMPS)
- Adapters
- Lighting application
- On-board DC/DC converter

MECHANICAL DATA

- Case: SOD-128
- Molding compound meets UL 94V-0 flammability rating
- Terminal: Matte tin plated leads, solderable per J-STD-002
- Meet JESD 201 class 2 whisker test
- Polarity: Indicated by cathode band
- Weight: 0.028g (approximately)

KEY PARAMETERS		
PARAMETER	VALUE	UNIT
I_F	1	A
V_{RRM}	40 - 200	V
I_{FSM}	30	A
T_{JMAX}	150	°C
Package	SOD-128	
Configuration	Single die	

SOD-128

ABSOLUTE MAXIMUM RATINGS ($T_A = 25^\circ\text{C}$ unless otherwise noted)							
PARAMETER	SYMBOL	SS14 FSH	SS16 FSH	SS110 FSH	SS115 FSH	SS120 FSH	UNIT
Marking code on the device		14FSH	16FSH	110FSH	115FSH	120FSH	
Repetitive peak reverse voltage	V_{RRM}	40	60	100	150	200	V
Reverse voltage, total rms value	$V_{R(RMS)}$	28	42	70	105	140	V
Forward current	I_F	1					A
Surge peak forward current, single half sine-wave superimposed on rated load	$t = 8.3\text{ms}$	30					A
	$t = 1.0\text{ms}$	95					A
Junction temperature	T_J	-55 to +150					°C
Storage temperature	T_{STG}	-55 to +150					°C

THERMAL PERFORMANCE			
PARAMETER	SYMBOL	TYP	UNIT
Junction-to-lead thermal resistance	$R_{\theta JL}$	20	$^{\circ}\text{C/W}$
Junction-to-ambient thermal resistance	$R_{\theta JA}$	75	$^{\circ}\text{C/W}$
Junction-to-case thermal resistance	$R_{\theta JC}$	18	$^{\circ}\text{C/W}$

Thermal Performance Note: Units mounted on PCB (5mm x 5mm Cu pad test board)

ELECTRICAL SPECIFICATIONS ($T_A = 25^{\circ}\text{C}$ unless otherwise noted)						
PARAMETER		CONDITIONS	SYMBOL	TYP	MAX	UNIT
Forward voltage ⁽¹⁾	SS14FSH	$I_F = 0.5\text{A}, T_J = 25^{\circ}\text{C}$	V_F	0.39	-	V
		$I_F = 1.0\text{A}, T_J = 25^{\circ}\text{C}$		0.44	0.55	V
		$I_F = 0.5\text{A}, T_J = 125^{\circ}\text{C}$		0.29	-	V
		$I_F = 1.0\text{A}, T_J = 125^{\circ}\text{C}$		0.37	0.46	V
	SS16FSH	$I_F = 0.5\text{A}, T_J = 25^{\circ}\text{C}$		0.49	-	V
		$I_F = 1.0\text{A}, T_J = 25^{\circ}\text{C}$		0.58	0.71	V
		$I_F = 0.5\text{A}, T_J = 125^{\circ}\text{C}$		0.42	-	V
		$I_F = 1.0\text{A}, T_J = 125^{\circ}\text{C}$		0.52	0.64	V
	SS110FSH	$I_F = 0.5\text{A}, T_J = 25^{\circ}\text{C}$		0.64	-	V
		$I_F = 1.0\text{A}, T_J = 25^{\circ}\text{C}$		0.75	0.83	V
		$I_F = 0.5\text{A}, T_J = 125^{\circ}\text{C}$		0.55	-	V
		$I_F = 1.0\text{A}, T_J = 125^{\circ}\text{C}$		0.60	0.67	V
	SS115FSH	$I_F = 0.5\text{A}, T_J = 25^{\circ}\text{C}$		0.72	-	V
		$I_F = 1.0\text{A}, T_J = 25^{\circ}\text{C}$		0.78	0.95	V
		$I_F = 0.5\text{A}, T_J = 125^{\circ}\text{C}$		0.57	-	V
		$I_F = 1.0\text{A}, T_J = 125^{\circ}\text{C}$		0.63	0.72	V
	SS120FSH	$I_F = 0.5\text{A}, T_J = 25^{\circ}\text{C}$		0.75	-	V
		$I_F = 1.0\text{A}, T_J = 25^{\circ}\text{C}$		0.81	1.10	V
		$I_F = 0.5\text{A}, T_J = 125^{\circ}\text{C}$		0.60	-	V
		$I_F = 1.0\text{A}, T_J = 125^{\circ}\text{C}$		0.66	0.80	V
Reverse current @ rated V_R ⁽²⁾	SS14FSH SS16FSH	$T_J = 25^{\circ}\text{C}$	I_R	-	100	μA
		$T_J = 125^{\circ}\text{C}$		-	40	mA
	SS110FSH SS115FSH SS120FSH	$T_J = 25^{\circ}\text{C}$		-	10	μA
		$T_J = 125^{\circ}\text{C}$		-	1	mA
Junction capacitance	SS14FSH	1MHz, $V_R = 4.0\text{V}$	C_J	69	-	pF
	SS16FSH			55	-	pF
	SS110FSH			36	-	pF
	SS115FSH			34	-	pF
	SS120FSH			30	-	pF

Notes:

1. Pulse test with $PW = 0.3\text{ms}$
2. Pulse test with $PW = 30\text{ms}$

ORDERING INFORMATION

ORDERING CODE⁽¹⁾	PACKAGE	PACKING
SS1xFSH	SOD-128	14,000 / Tape & Reel

Notes:

1. "x" defines voltage from 40V(SS14FSH) to 200V(SS120FSH)

CHARACTERISTICS CURVES

($T_A = 25^\circ\text{C}$ unless otherwise noted)

Fig.1 Forward Current Derating Curve

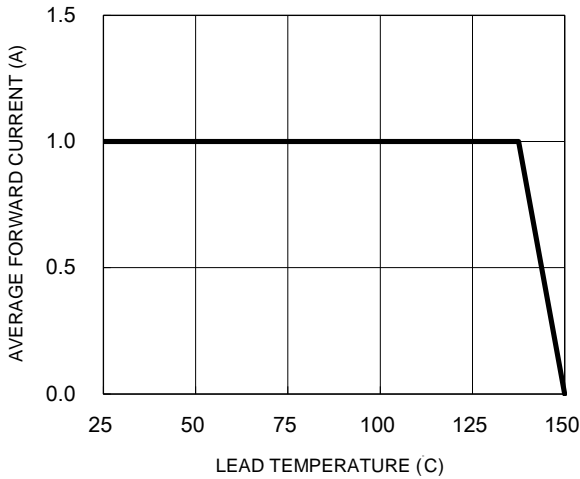

Fig.2 Typical Junction Capacitance

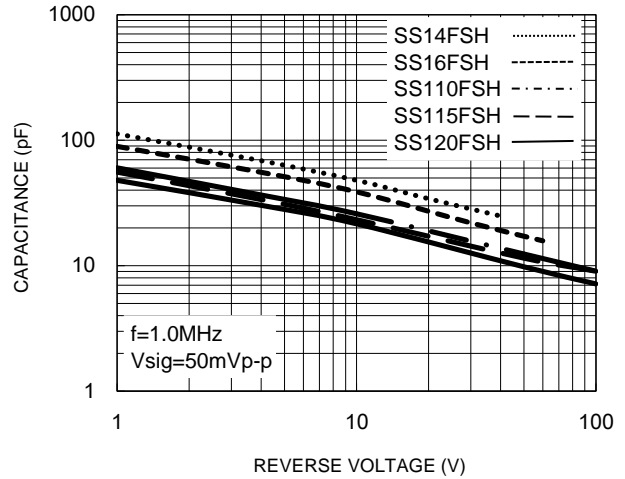

Fig.3 Typical Reverse Characteristics

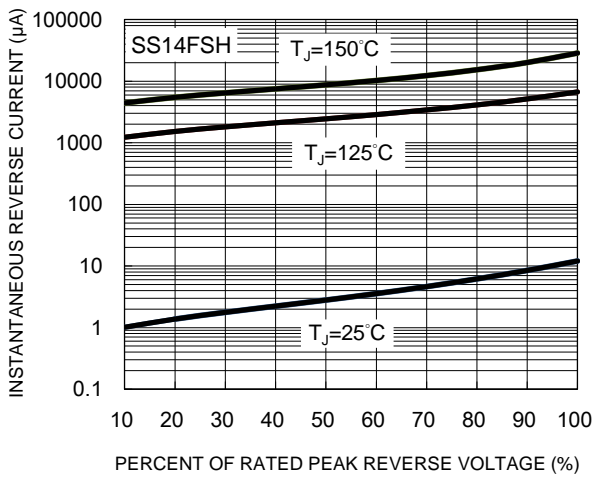

Fig.4 Typical Forward Characteristics

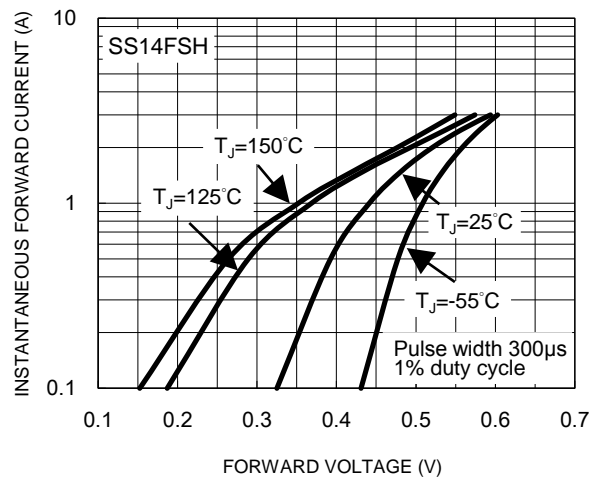

Fig.5 Typical Reverse Characteristics

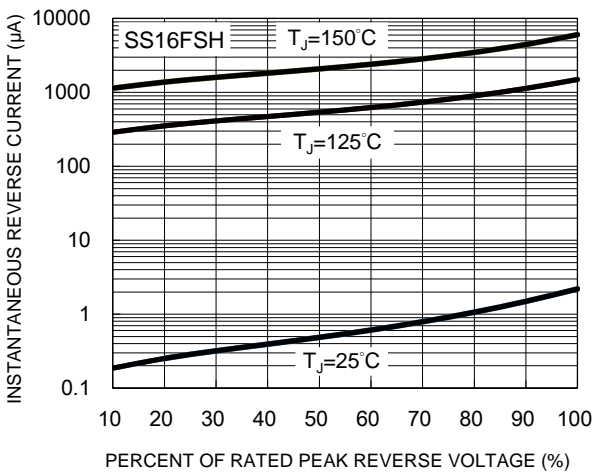
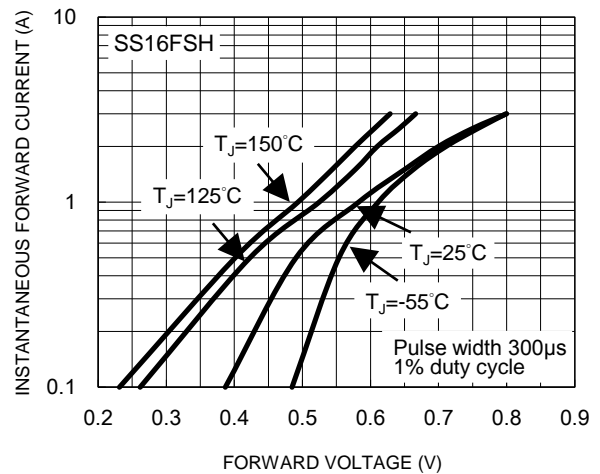

Fig.6 Typical Forward Characteristics



CHARACTERISTICS CURVES

($T_A = 25^\circ\text{C}$ unless otherwise noted)

Fig.7 Typical Reverse Characteristics

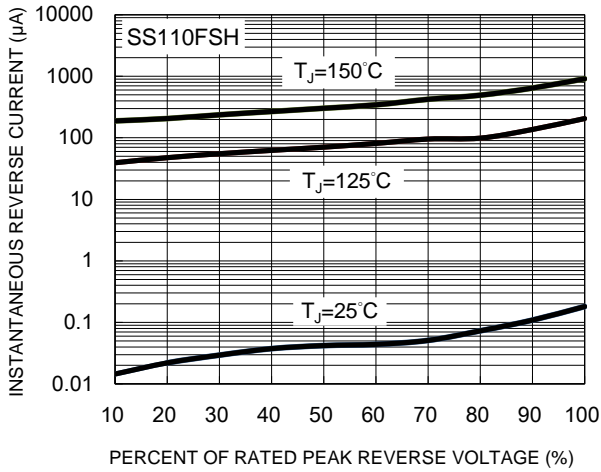

Fig.9 Typical Reverse Characteristics

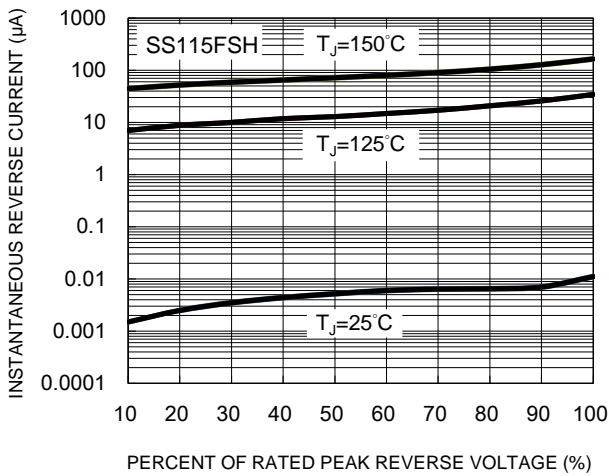

Fig.11 Typical Reverse Characteristics

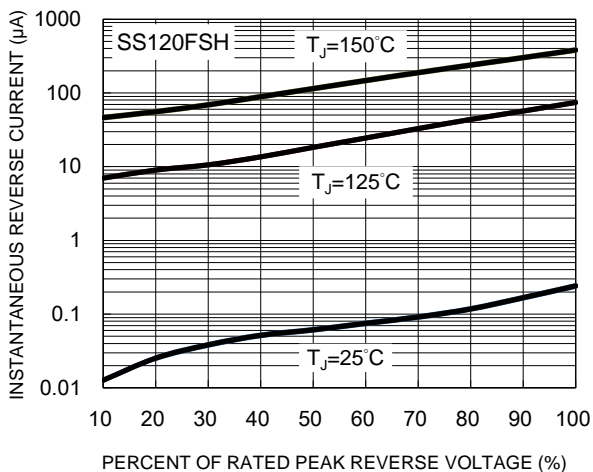

Fig.8 Typical Forward Characteristics

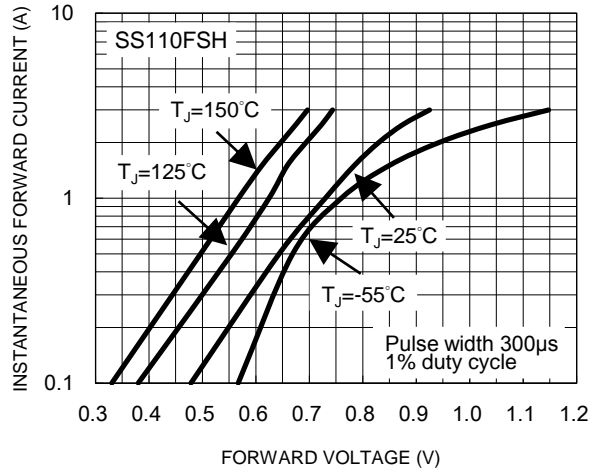

Fig.10 Typical Forward Characteristics

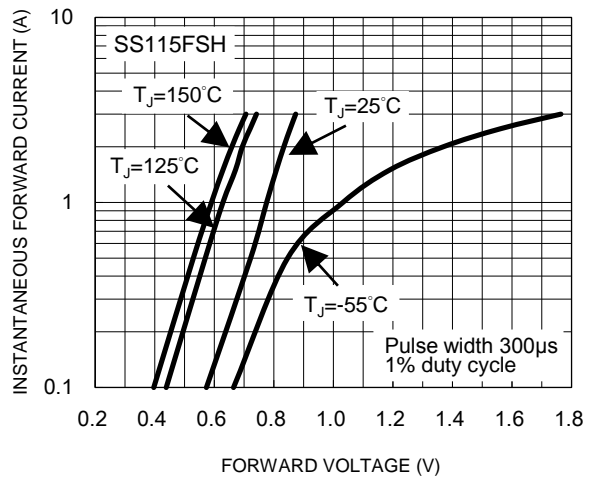
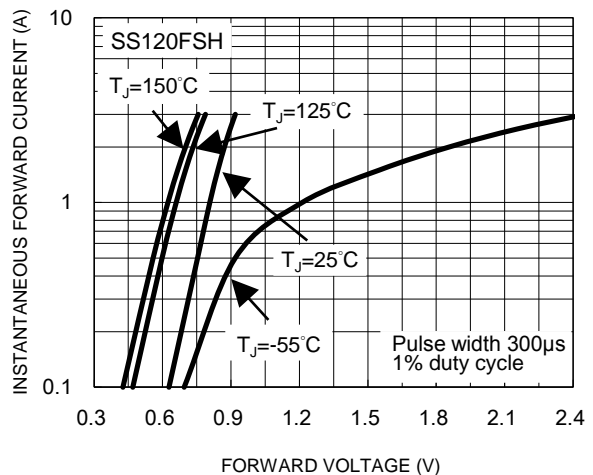

Fig.12 Typical Forward Characteristics



CHARACTERISTICS CURVES

(T_A = 25°C unless otherwise noted)

Fig.13 Typical Transient Thermal Impedance

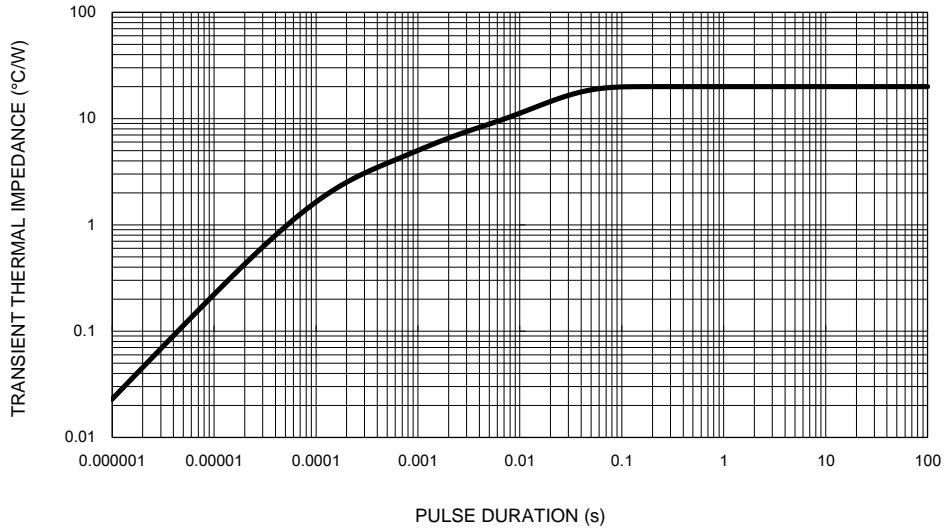

PACKAGE OUTLINE DIMENSIONS

SOD-128

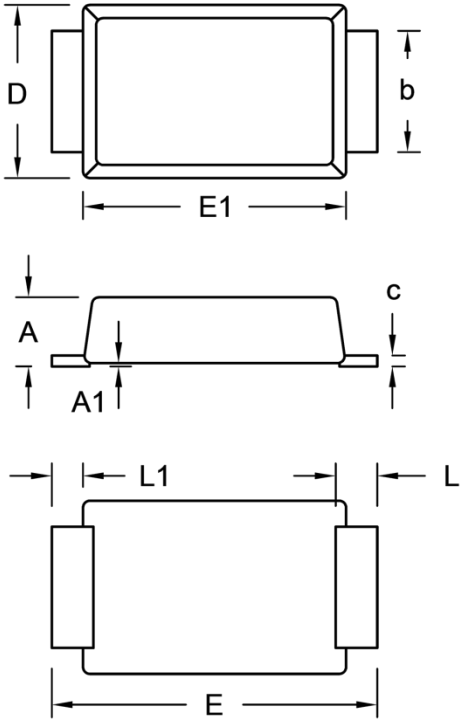

DIM.	Unit (mm)		Unit (inch)	
	Min.	Max.	Min.	Max.
A	0.90	1.10	0.035	0.043
A1	0.00	0.10	0.000	0.004
b	1.60	1.90	0.063	0.075
c	0.10	0.22	0.004	0.009
D	2.30	2.70	0.091	0.106
E	4.40	5.00	0.173	0.197
E1	3.60	4.00	0.142	0.157
L	0.40	0.80	0.016	0.031
L1	0.30	0.60	0.012	0.024

SUGGESTED PAD LAYOUT

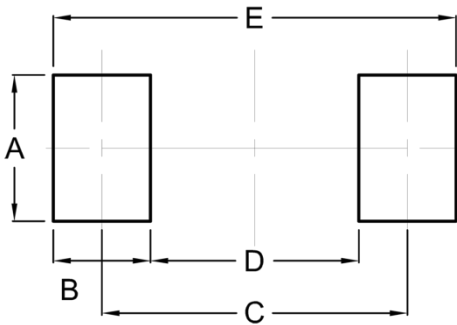

Symbol	Unit (mm)	Unit (inch)
A	2.10	0.083
B	1.40	0.055
C	4.40	0.173
D	3.00	0.118
E	5.80	0.228

MARKING DIAGRAM



- P/N = Marking Code
- YW = Date Code
- F = Factory Code