

**SURFACE MOUNT SCHOTTKY  
BARRIER RECTIFIER**  
VOLTAGE RANGE 20 to 100 Volts CURRENT 1.0 Ampere

**FEATURES**

- \* Low power loss, high efficiency
- \* Low leakage
- \* Low forward voltage drop
- \* High current capability
- \* High speed switching
- \* High surge capability
- \* High reliability
- \* Guard ring construction on dice
- \* ESD: HBM class 3B ,MM class M4
- \* P/N suffix V means AEC-Q101 qualified, e.g:SS20V
- \* P/N suffix V means Halogen-free

**MECHANICAL DATA**

- \* Epoxy: Device has UL flammability classification 94V-0
- \* Mounting position: Any
- \* Weight:0.018gram (Approx.)
- \* Flat lead frame

**MAXIMUM RATINGS AND ELECTRICAL CHARACTERISTICS**

Ratings at 25 °C ambient temperature unless otherwise specified.  
Resistive or inductive load.

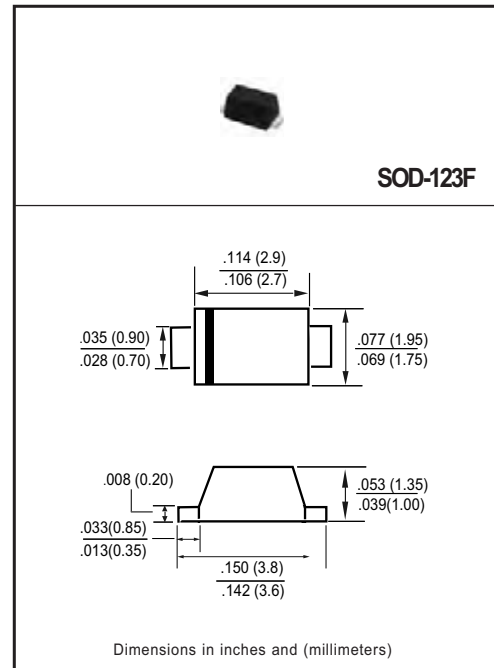

**MAXIMUM RATINGS (@ TA=25 °C unless otherwise noted)**

RATINGS	SYMBOL	SS20	SS30	SS40	SS50	SS60	SS80	SS100	UNITS
Maximum Recurrent Peak Reverse Voltage	V <sub>RRM</sub>	20	30	40	50	60	80	100	Volts
Maximum RMS Voltage	V <sub>RMS</sub>	14	21	28	35	42	56	70	Volts
Maximum DC Blocking Voltage	V <sub>DC</sub>	20	30	40	50	60	80	100	Volts
Maximum Average Forward Rectified Current @ TA=75 °C	I <sub>O</sub>	1.0							Amps
Peak Forward Surge Current 8.3 ms single half sine-wave superimposed on rated load (JEDEC method)	I <sub>FSM</sub>	40							Amps
Typical Current Square Time	I <sup>2</sup> T	6.6							A <sup>2</sup> S
Typical Thermal Resistance (Note 3)	R <sub>θJA</sub>	110							°C/W
	R <sub>θJL</sub>	30							
Operating Temperature Range	T <sub>J</sub>	-55 to + 150							°C
Storage Temperature Range	T <sub>STG</sub>	-55 to + 150							°C
Total Capacitance (Note 1)	C <sub>T</sub>	75							pF

**ELECTRICAL CHARACTERISTICS(@TA=25 °C unless otherwise noted)**

CHARACTERISTICS	SYMBOL	SS20	SS30	SS40	SS50	SS60	SS80	SS100	UNITS
Maximum Instantaneous Forward Voltage at 1.0A DC	V <sub>F</sub>	0.55			0.70		0.85		Volts
Maximum Average Reverse Current at Rated DC Blocking Voltage	@TA = 25°C	0.2							mAmps
	@TA =150 °C	5							mAmps

- NOTES : 1. Measured at 1 MHz and applied reverse voltage of 4 Volts.  
2."ROHS compliant"  
3. Thermal Resistance: Mounted on PCB.

## RATING AND CHARACTERISTICS CURVES (SS20 THRU SS100)

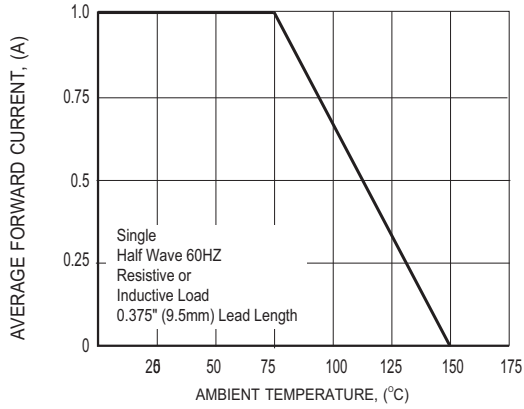

FIG.1 TYPICAL FORWARD CURRENT DERATING CURVE

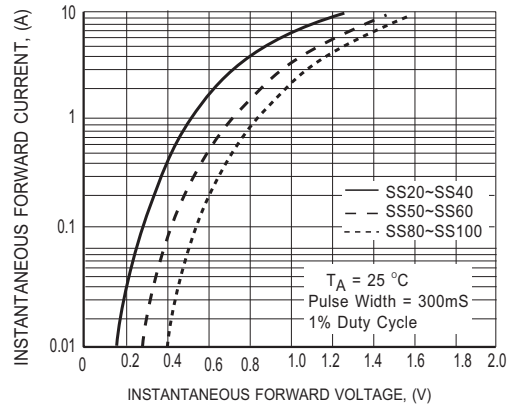

FIG.2 MAXIMUM INSTANTANEOUS FORWARD CHARACTERISTICS

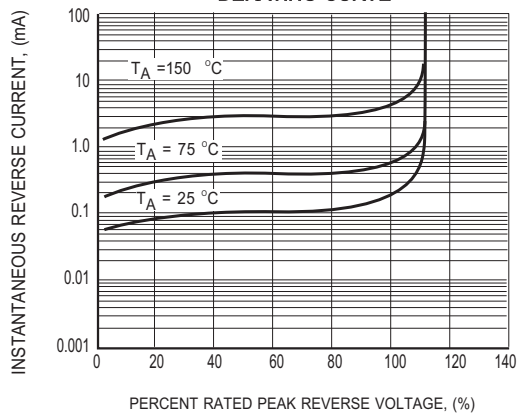

FIG.3 MAXIMUM REVERSE CHARACTERISTICS

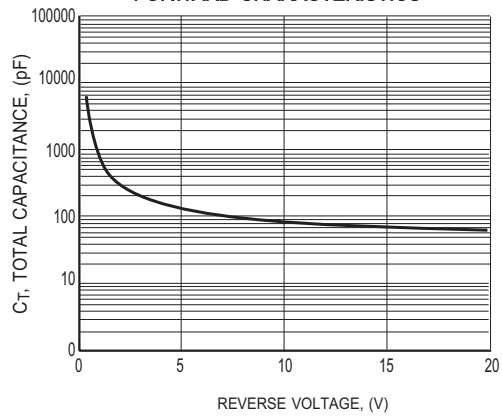

FIG.4 TYPICAL TOTAL CAPACITANCE

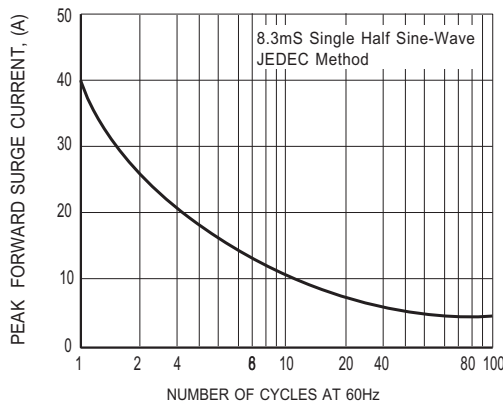
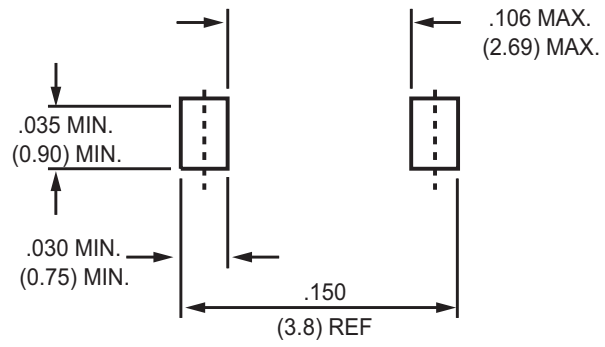

FIG.5 TYPICAL REVERSE CHARACTERISTICS

## Mounting Pad Layout



Dimensions in inches and (millimeters)

## Marking Description

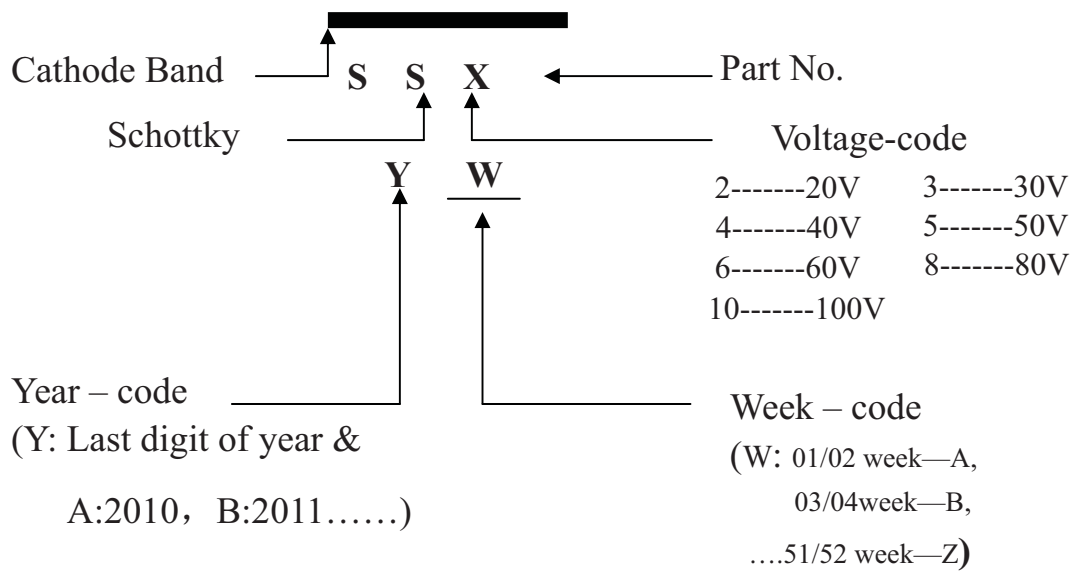

## PACKAGING OF DIODE AND BRIDGE RECTIFIERS

### REEL PACK

PACKAGE	PACKING CODE	EA PER REEL	EA PER INNER BOX	COMPONENT SPACE (mm)	TAPE SPACE (mm)	REEL DIA (mm)	CARTON SIZE (mm)	EA PER CARTON	GROSS WEIGHT(Kg)
SOD-123F/ SOD-123FL	-W	3,000	15,000	---	---	178	390*205*31	120,000	6.964