

## TruStability® Silicon Pressure Sensors: SSC Series—Standard Accuracy

±2% Total Error Band,  
Amplified Compensated Digital Output,  
1 psi to 150 psi (60 mbar to 10 bar)

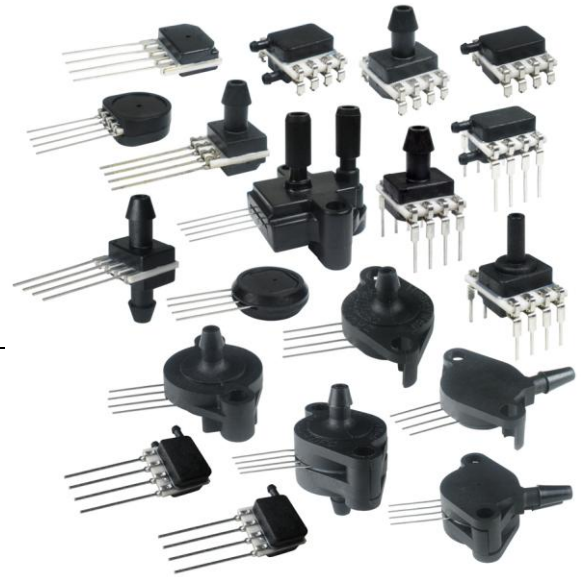

### DESCRIPTION

The TruStability® Standard Accuracy Silicon Ceramic (SSC) Series is a piezoresistive silicon pressure sensor offering a digital output for reading pressure over the specified full scale pressure span and temperature range.

The SSC Series is fully calibrated and temperature compensated for sensor offset, sensitivity, temperature effects, and non-linearity using an on-board Application Specific Integrated Circuit (ASIC). Calibrated output values for pressure are updated at approximately 2 kHz.

The SSC Series is calibrated over the temperature range of -20 °C to 85 °C [-4 °F to 185 °F]. The sensor is characterized for operation from a single power supply of either 3.3 Vdc or 5.0 Vdc.

These sensors measure absolute, differential, and gage pressures. The absolute versions have an internal vacuum reference and an output value proportional to absolute pressure. Differential versions allow application of pressure to either side of the sensing diaphragm. Gage versions are referenced to atmospheric pressure and provide an output proportional to pressure variations from atmosphere.

The TruStability® pressure sensors are intended for use with non-corrosive, non-ionic gases, such as air and other dry gases. An available option extends the performance of these sensors to non-corrosive, non-ionic liquids.

All products are designed and manufactured according to ISO 9001 standards.

### FEATURES

- Industry-leading long-term stability
- Extremely tight accuracy of ±0.25% FSS BFSL (Full Scale Span Best Fit Straight Line)
- Total error band of ±2% full scale span maximum
- Modular and flexible design offers customers a variety of package styles and options, all with the same industry-leading performance specifications
- Miniature 10 mm x 10 mm [0.39 in x 0.39 in] package
- Low operating voltage
- Extremely low power consumption
- I<sup>2</sup>C- or SPI- compatible 14-bit digital output (min. 12-bit sensor resolution)
- Precision ASIC conditioning and temperature compensated over -20 °C to 85 °C [-4 °F to 185 °F] temperature range
- RoHS compliant
- Virtually insensitive to mounting orientation
- Internal diagnostic functions increase system reliability
- Also available with analog output
- Absolute, differential, and gage types
- Pressure ranges from 1 psi to 150 psi (60 mbar to 10 bar)
- Custom calibration available
- Various pressure port options
- Liquid media option

# TruStability® Silicon Pressure Sensors: SSC Series—High Accuracy

## POTENTIAL APPLICATIONS

- |   |  |
|---|--|
| <ul style="list-style-type: none"> <li>• <b>Medical:</b> <ul style="list-style-type: none"> <li>- Airflow monitors</li> <li>- Anesthesia machines</li> <li>- Blood analysis machines</li> <li>- Gas chromatography</li> <li>- Gas flow instrumentation</li> <li>- Kidney dialysis machines</li> <li>- Oxygen concentrators</li> <li>- Pneumatic controls</li> <li>- Respiratory machines</li> <li>- Sleep apnea equipment</li> <li>- Ventilators</li> </ul> </li> </ul> | <ul style="list-style-type: none"> <li>• <b>Industrial:</b> <ul style="list-style-type: none"> <li>- Barometry</li> <li>- Flow calibrators</li> <li>- Gas chromatography</li> <li>- Gas flow instrumentation</li> <li>- HVAC</li> <li>- Life sciences</li> <li>- Pneumatic controls</li> </ul> </li> </ul> |
|---|--|

**Table 1. Absolute Maximum Ratings<sup>1</sup>**

| Parameter                              | Min.                         | Max.                      | Unit    |
|--|------------------------------|---------------------------|---------|
| Supply voltage ( $V_{\text{supply}}$ ) | -0.3                         | 6.0                       | Vdc     |
| Voltage on any pin                     | -0.3                         | $V_{\text{supply}} + 0.3$ | V       |
| Digital interface clock frequency:     |                              |                           |         |
| I <sup>2</sup> C                       | 100                          | 400                       | kHz     |
| SPI                                    | 50                           | 800                       |         |
| ESD susceptibility (human body model)  | 3                            | -                         | kV      |
| Storage temperature                    | -40 [-40]                    | 85 [185]                  | °C [°F] |
| Soldering time and temperature:        |                              |                           |         |
| Lead solder (SIP, DIP)                 | 4 s max. at 250 °C [482 °F]  |                           |         |
| Peak reflow (SMT)                      | 15 s max. at 250 °C [482 °F] |                           |         |

**Table 2. Operating Specifications**

| Parameter   | Min.      | Typ.             | Max.     | Unit                |
|---|-----------|------------------|----------|---------------------|
| Supply voltage ( $V_{\text{supply}}$ ) <sup>2</sup> :                   |           |                  |          | Vdc                 |
| 3.3 Vdc   | 3.0       | 3.3 <sup>3</sup> | 3.6      |                     |
| 5.0 Vdc   | 4.75      | 5.0 <sup>3</sup> | 5.25     |                     |
| <i>Sensors are either 3.3 Vdc or 5.0 Vdc based on listing selected.</i> |           |                  |          |                     |
| Supply current:   |           |                  |          | mA                  |
| 3.3 Vdc supply  | -         | 1.6              | 2.1      |                     |
| 5.0 Vdc supply  | -         | 2                | 3        |                     |
| Compensated temperature range <sup>4</sup>                              | -20 [-4]  | -                | 85 [185] | °C [°F]             |
| Operating temperature range <sup>5</sup>                                | -40 [-40] | -                | 85 [185] | °C [°F]             |
| Startup time (power up to data ready)                                   | -         | 2.8              | 7.3      | ms                  |
| Response time   | -         | 0.46             | -        | ms                  |
| I <sup>2</sup> C voltage level low                                      | -         | -                | 0.2      | $V_{\text{supply}}$ |
| I <sup>2</sup> C voltage level high                                     | 0.8       | -                | -        | $V_{\text{supply}}$ |
| Pull up on SDA and SCL  | 1         | -                | -        | kOhm                |
| Accuracy <sup>6</sup>   | -         | -                | ±0.25    | %FSS BFSL           |
| Total error band <sup>7</sup>   | -         | -                | ±2       | %FSS <sup>8</sup>   |
| Output resolution   | 12        | -                | -        | bits                |

## ±2% Total Error Band, Digital Output, 1 psi to 150 psi (60 mbar to 10 bar)

**Table 3. Environmental Specifications**

| Parameter   | Characteristic   |
|---|--|
| Humidity:<br>Dry gases only (See "Options N and D" in Figure 1.)<br>Liquid media (See "Options T and V" in Figure 1.) | 0% to 95% RH, non-condensing<br>100% condensing or direct liquid media on Port 1 |
| Vibration   | MIL-STD-202F, Curve AK (20.7 g random)   |
| Shock   | MIL-STD-202F, Method 213B, Condition F   |
| Life <sup>9</sup>   | 1 million cycles minimum   |
| Solder reflow   | J-STD-020-C  |

**Table 4. Wetted Materials<sup>10</sup>**

| Parameter             | Port 1 (Pressure Port)          | Port 2 (Reference Port)      |
|-----------------------|---------------------------------|------------------------------|
| Covers                | high temperature polyamide      | high temperature polyamide   |
| Substrate             | alumina ceramic                 | alumina ceramic              |
| Adhesives             | epoxy, silicone                 | epoxy, silicone              |
| Electronic components | ceramic, glass, solder, silicon | silicon, glass, gold, solder |

**Notes:**

1. Absolute maximum ratings are the extreme limits the device will withstand without damage.
2. Ratiometricity of the sensor (the ability of the digital device to maintain performance parameters independent of supply voltage) is achieved within the specified operating voltage for each option.
3. The sensor is not reverse polarity protected. Incorrect application of supply voltage or ground to the wrong pin may cause electrical failure.
4. The compensated temperature range is the temperature range over which the sensor will produce an output proportional to pressure within the specified performance limits.
5. The operating temperature range is the temperature range over which the sensor will produce an output proportional to pressure but may not remain within the specified performance limits.
6. Accuracy: The maximum deviation in output from a Best Fit Straight Line (BFSL) fitted to the output measured over the pressure range at 25 °C [77 °F]. Includes all errors due to pressure non-linearity, pressure hysteresis, and non-repeatability.
7. Total Error Band: The maximum deviation from the ideal transfer function over the entire compensated temperature and pressure range. Includes all errors due to offset, full scale span, pressure non-linearity, pressure hysteresis, repeatability, thermal effect on offset, thermal effect on span, and thermal hysteresis.
8. Full Scale Span (FSS) is the algebraic difference between the output signal measured at the maximum (Pmax.) and minimum (Pmin.) limits of the pressure range. (See Figure 1 for ranges.)
9. Life may vary depending on specific application in which sensor is utilized.
10. Contact Honeywell Customer Service for detailed material information.

### CAUTION

**PRODUCT DAMAGE**

- Ensure liquid media is applied to Port 1 only; Port 2 is not compatible with liquids.
- Ensure liquid media contains no particulates. All TruStability<sup>®</sup> sensors are dead-ended devices. Particulates can accumulate inside the sensor, causing damage or affecting sensor output.
- Recommend that the sensor be positioned with Port 1 facing downwards; any particulates in the system are less likely to enter and settle within the pressure sensor if it is in this position.
- Ensure liquid media does not create a residue when dried; build-up inside the sensor may affect sensor output. Rinsing of a dead-ended sensor is difficult and has limited effectiveness for removing residue.
- Ensure liquid media are compatible with wetted materials. Non-compatible liquid media will degrade sensor performance and may lead to sensor failure.

**Failure to comply with these instructions may result in product damage.**

# TruStability® Silicon Pressure Sensors: SSC Series—Standard Accuracy

Figure 1. Nomenclature and Order Guide

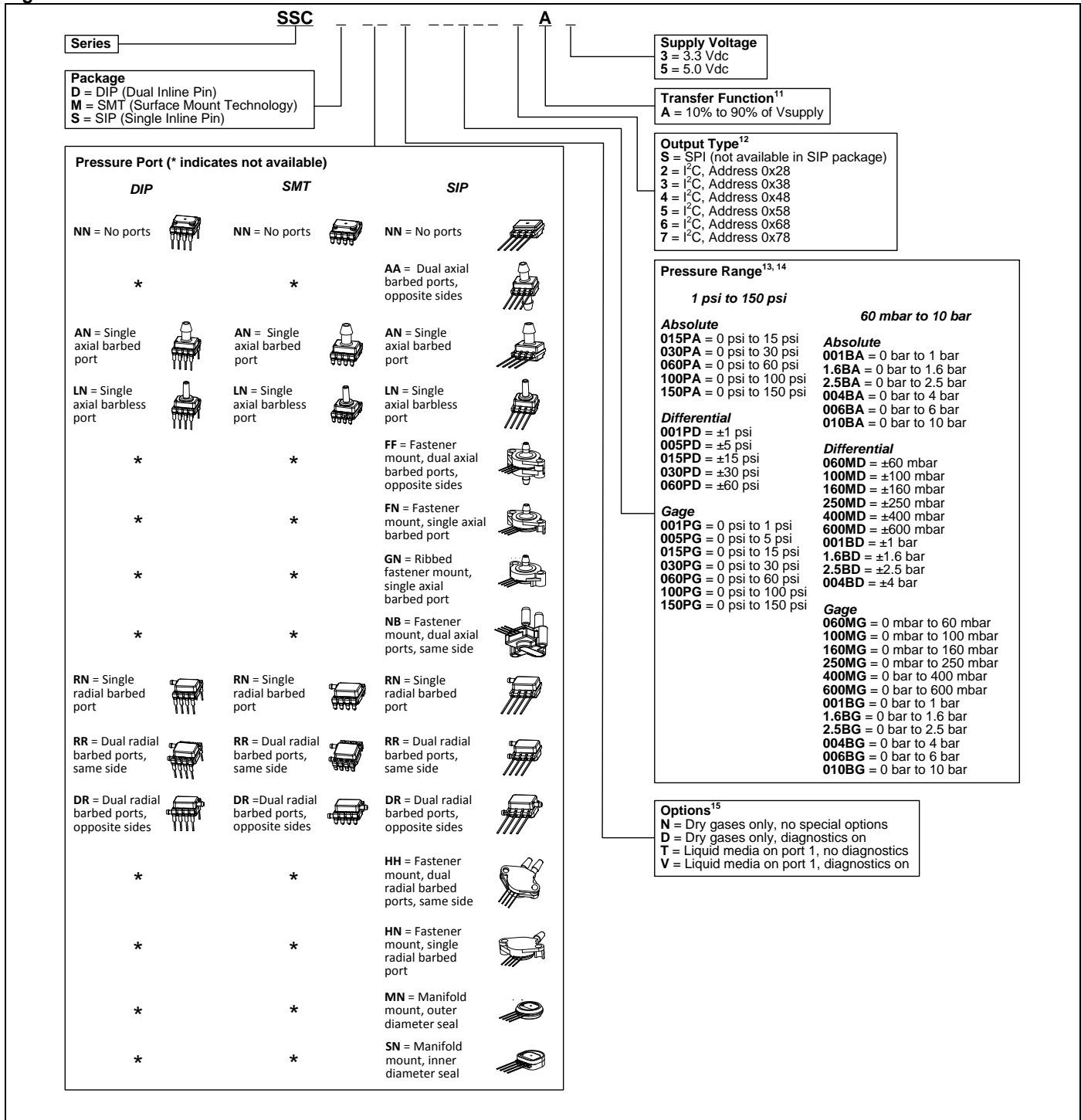

**Notes:**

- The transfer function limits define the output of the sensor at a given pressure input. By specifying Pmin. and Pmax., the output at Pmin. and Pmax., the complete transfer function of the sensor is defined. See Figure 2 for a graphical representation of the transfer function. Other transfer functions are available. Contact Honeywell Customer Service for more information.
- Analog output is also available. Contact Honeywell Customer Service for more information.
- Custom pressure ranges are available. Contact Honeywell Customer Service for more information.
- See Table 5 for an explanation of sensor pressure types.
- See **CAUTION** on previous page.

±2% Total Error Band, Digital Output, 1 psi to 150 psi (60 mbar to 10 bar)

Figure 2. Transfer Function Limits

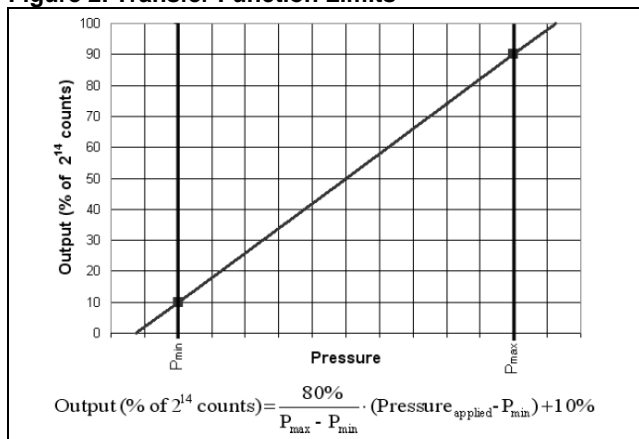

Figure 3. Completed Catalog Listing Example

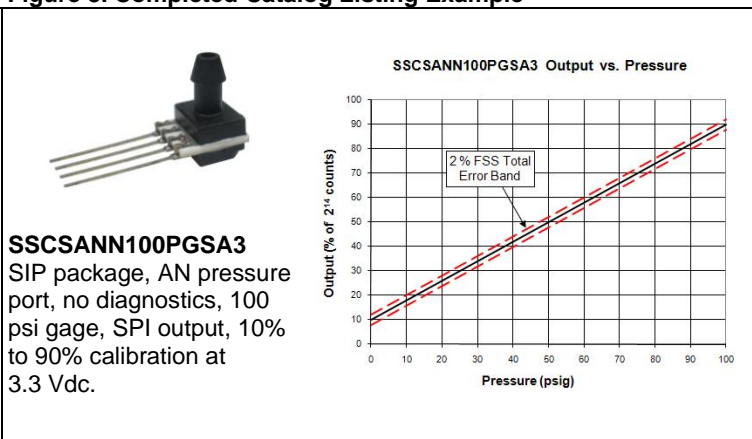

Table 5. Pressure Types

| Pressure Type | Description   |
|---------------|---|
| Absolute      | Output is proportional to the difference between applied pressure and a built-in reference to vacuum. P <sub>min.</sub> is set at absolute zero pressure (full vacuum). |
| Differential  | Output is proportional to the difference between the pressures applied to each port. (Port 1 – Port 2) 50% point of transfer function set at Port 1 = Port 2.           |
| Gage          | Output is proportional to the difference between applied pressure and atmospheric (ambient) pressure. P <sub>min.</sub> is set at atmospheric pressure.                 |

Table 6. Sensor Output at Significant Percentages

| % Output | Digital Counts (decimal) | Digital Counts (hex) |
|----------|--------------------------|----------------------|
| 0        | 0                        | 0x0000               |
| 10       | 1638                     | 0x0666               |
| 50       | 8192                     | 0x2000               |
| 90       | 14746                    | 0x399A               |
| 100      | 16383                    | 0x3FFF               |

Table 7. Pressure Range Specifications for 1 psi to 150 psi

| Order Code          | Pressure Range    |                   | Over-pressure <sup>16</sup> | Burst Pressure <sup>17</sup> | Common Mode Pressure <sup>18</sup> | Long-term Stability (1000 hr, 25 °C [77 °F]) |
|---------------------|-------------------|-------------------|-----------------------------|------------------------------|------------------------------------|--|
|                     | P <sub>min.</sub> | P <sub>max.</sub> |                             |                              |                                    |  |
| <b>Absolute</b>     |                   |                   |                             |                              |                                    |  |
| 015PA               | 0 psi             | 15 psi            | 30 psi                      | 60 psi                       | NA                                 | ±0.25% FSS                                   |
| 030PA               | 0 psi             | 30 psi            | 60 psi                      | 120 psi                      | NA                                 | ±0.25% FSS                                   |
| 060PA               | 0 psi             | 60 psi            | 120 psi                     | 240 psi                      | NA                                 | ±0.25% FSS                                   |
| 100PA               | 0 psi             | 100 psi           | 250 psi                     | 250 psi                      | NA                                 | ±0.25% FSS                                   |
| 150PA               | 0 psi             | 150 psi           | 250 psi                     | 250 psi                      | NA                                 | ±0.25% FSS                                   |
| <b>Differential</b> |                   |                   |                             |                              |                                    |  |
| 001PD               | -1 psi            | 1 psi             | 10 psi                      | 10 psi                       | 150 psi                            | ±0.35% FSS                                   |
| 005PD               | -5 psi            | 5 psi             | 30 psi                      | 40 psi                       | 150 psi                            | ±0.35% FSS                                   |
| 015PD               | -15 psi           | 15 psi            | 30 psi                      | 60 psi                       | 150 psi                            | ±0.25% FSS                                   |
| 030PD               | -30 psi           | 30 psi            | 60 psi                      | 120 psi                      | 150 psi                            | ±0.25% FSS                                   |
| 060PD               | -60 psi           | 60 psi            | 120 psi                     | 240 psi                      | 250 psi                            | ±0.25% FSS                                   |
| <b>Gage</b>         |                   |                   |                             |                              |                                    |  |
| 001PG               | 0 psi             | 1 psi             | 10 psi                      | 10 psi                       | 150 psi                            | ±0.35% FSS                                   |
| 005PG               | 0 psi             | 5 psi             | 30 psi                      | 40 psi                       | 150 psi                            | ±0.35% FSS                                   |
| 015PG               | 0 psi             | 15 psi            | 30 psi                      | 60 psi                       | 150 psi                            | ±0.25% FSS                                   |
| 030PG               | 0 psi             | 30 psi            | 60 psi                      | 120 psi                      | 150 psi                            | ±0.25% FSS                                   |
| 060PG               | 0 psi             | 60 psi            | 120 psi                     | 240 psi                      | 250 psi                            | ±0.25% FSS                                   |
| 100PG               | 0 psi             | 100 psi           | 250 psi                     | 250 psi                      | 250 psi                            | ±0.25% FSS                                   |
| 150PG               | 0 psi             | 150 psi           | 250 psi                     | 250 psi                      | 250 psi                            | ±0.25% FSS                                   |

# TruStability® Silicon Pressure Sensors: SSC Series—Standard Accuracy

Table 8. Pressure Range Specifications for 60 mbar to 10 bar

| Order Code          | Pressure Range    |                   | Over-pressure <sup>16</sup> | Burst Pressure <sup>17</sup> | Common Mode Pressure <sup>18</sup> | Long-term Stability (1000 hr, 25 °C [77 °F]) |
|---------------------|-------------------|-------------------|-----------------------------|------------------------------|------------------------------------|--|
|                     | P <sub>min.</sub> | P <sub>max.</sub> |                             |                              |                                    |  |
| <b>Absolute</b>     |                   |                   |                             |                              |                                    |  |
| 001BA               | 0 bar             | 1 bar             | 2 bar                       | 4 bar                        | NA                                 | ±0.25% FSS                                   |
| 1.6BA               | 0 bar             | 1.6 bar           | 4 bar                       | 8 bar                        | NA                                 | ±0.25% FSS                                   |
| 2.5BA               | 0 bar             | 2.5 bar           | 6 bar                       | 8 bar                        | NA                                 | ±0.25% FSS                                   |
| 004BA               | 0 bar             | 4 bar             | 8 bar                       | 16 bar                       | NA                                 | ±0.25% FSS                                   |
| 006BA               | 0 bar             | 6 bar             | 17 bar                      | 17 bar                       | NA                                 | ±0.25% FSS                                   |
| 010BA               | 0 bar             | 10 bar            | 17 bar                      | 17 bar                       | NA                                 | ±0.25% FSS                                   |
| <b>Differential</b> |                   |                   |                             |                              |                                    |  |
| 060MD               | -60 mbar          | 60 mbar           | 500 mbar                    | 700 mbar                     | 10 bar                             | ±0.35% FSS                                   |
| 100MD               | -100 mbar         | 100 mbar          | 500 mbar                    | 700 mbar                     | 10 bar                             | ±0.35% FSS                                   |
| 160MD               | -160 mbar         | 160 mbar          | 500 mbar                    | 700 mbar                     | 10 bar                             | ±0.35% FSS                                   |
| 250MD               | -250 mbar         | 250 mbar          | 1.4 bar                     | 2.5 bar                      | 10 bar                             | ±0.35% FSS                                   |
| 400MD               | -400 mbar         | 400 mbar          | 1.4 bar                     | 2.5 bar                      | 10 bar                             | ±0.35% FSS                                   |
| 600MD               | -600 mbar         | 600 mbar          | 2 bar                       | 4 bar                        | 10 bar                             | ±0.25% FSS                                   |
| 001BD               | -1 bar            | 1 bar             | 2 bar                       | 4 bar                        | 10 bar                             | ±0.25% FSS                                   |
| 1.6BD               | -1.6 bar          | 1.6 bar           | 4 bar                       | 8 bar                        | 10 bar                             | ±0.25% FSS                                   |
| 2.5BD               | -2.5 bar          | 2.5 bar           | 6 bar                       | 8 bar                        | 10 bar                             | ±0.25% FSS                                   |
| 004BD               | -4 bar            | 4 bar             | 8 bar                       | 16 bar                       | 10 bar                             | ±0.25% FSS                                   |
| <b>Gage</b>         |                   |                   |                             |                              |                                    |  |
| 060MG               | 0 mbar            | 60 mbar           | 500 mbar                    | 700 mbar                     | 3.5 bar                            | ±0.35% FSS                                   |
| 100MG               | 0 mbar            | 100 mbar          | 500 mbar                    | 700 mbar                     | 10 bar                             | ±0.35% FSS                                   |
| 160MG               | 0 mbar            | 160 mbar          | 500 mbar                    | 700 mbar                     | 10 bar                             | ±0.35% FSS                                   |
| 250MG               | 0 mbar            | 250 mbar          | 1.4 bar                     | 2.5 bar                      | 10 bar                             | ±0.35% FSS                                   |
| 400MG               | 0 mbar            | 400 mbar          | 1.4 bar                     | 2.5 bar                      | 10 bar                             | ±0.35% FSS                                   |
| 600MG               | 0 mbar            | 600 mbar          | 2 bar                       | 4 bar                        | 10 bar                             | ±0.35% FSS                                   |
| 001BG               | 0 bar             | 1 bar             | 2 bar                       | 4 bar                        | 10 bar                             | ±0.25% FSS                                   |
| 1.6BG               | 0 bar             | 1.6 bar           | 4 bar                       | 8 bar                        | 10 bar                             | ±0.25% FSS                                   |
| 2.5BG               | 0 bar             | 2.5 bar           | 6 bar                       | 8 bar                        | 10 bar                             | ±0.25% FSS                                   |
| 004BG               | 0 bar             | 4 bar             | 8 bar                       | 16 bar                       | 16 bar                             | ±0.25% FSS                                   |
| 006BG               | 0 bar             | 6 bar             | 17 bar                      | 17 bar                       | 17 bar                             | ±0.25% FSS                                   |
| 010BG               | 0 bar             | 10 bar            | 17 bar                      | 17 bar                       | 17 bar                             | ±0.25% FSS                                   |

**Notes:**

16. Overpressure: The maximum pressure which may safely be applied to the product for it to remain in specification once pressure is returned to the operating pressure range. Exposure to higher pressures may cause permanent damage to the product. Unless otherwise specified this applies to all available pressure ports at any temperature with the operating temperature range.
17. Burst pressure: The maximum pressure that may be applied to any port of the product without causing escape of pressure media. Product should not be expected to function after exposure to any pressure beyond the burst pressure.
18. Common mode pressure: The maximum pressure that can be applied simultaneously to both ports of a differential pressure sensor without causing changes in specified performance.

Table 9. Pinout for SMT and DIP Packages

| Output Type      | Pin 1 | Pin 2               | Pin 3 | Pin 4 | Pin 5 | Pin 6 | Pin 7 | Pin 8 |
|------------------|-------|---------------------|-------|-------|-------|-------|-------|-------|
| I <sup>2</sup> C | GND   | V <sub>supply</sub> | SDA   | SCL   | NC    | NC    | NC    | NC    |
| SPI              | GND   | V <sub>supply</sub> | MISO  | SCLK  | SS    | NC    | NC    | NC    |

Table 10. Pinout for SIP Package

| Output Type      | Pin 1 | Pin 2               | Pin 3 | Pin 4 |
|------------------|-------|---------------------|-------|-------|
| I <sup>2</sup> C | GND   | V <sub>supply</sub> | SDA   | SCL   |

±2% Total Error Band, Digital Output, 1 psi to 150 psi (60 mbar to 10 bar)

Figure 4. DIP Pressure Port Dimensional Drawings (For reference only: mm [in])

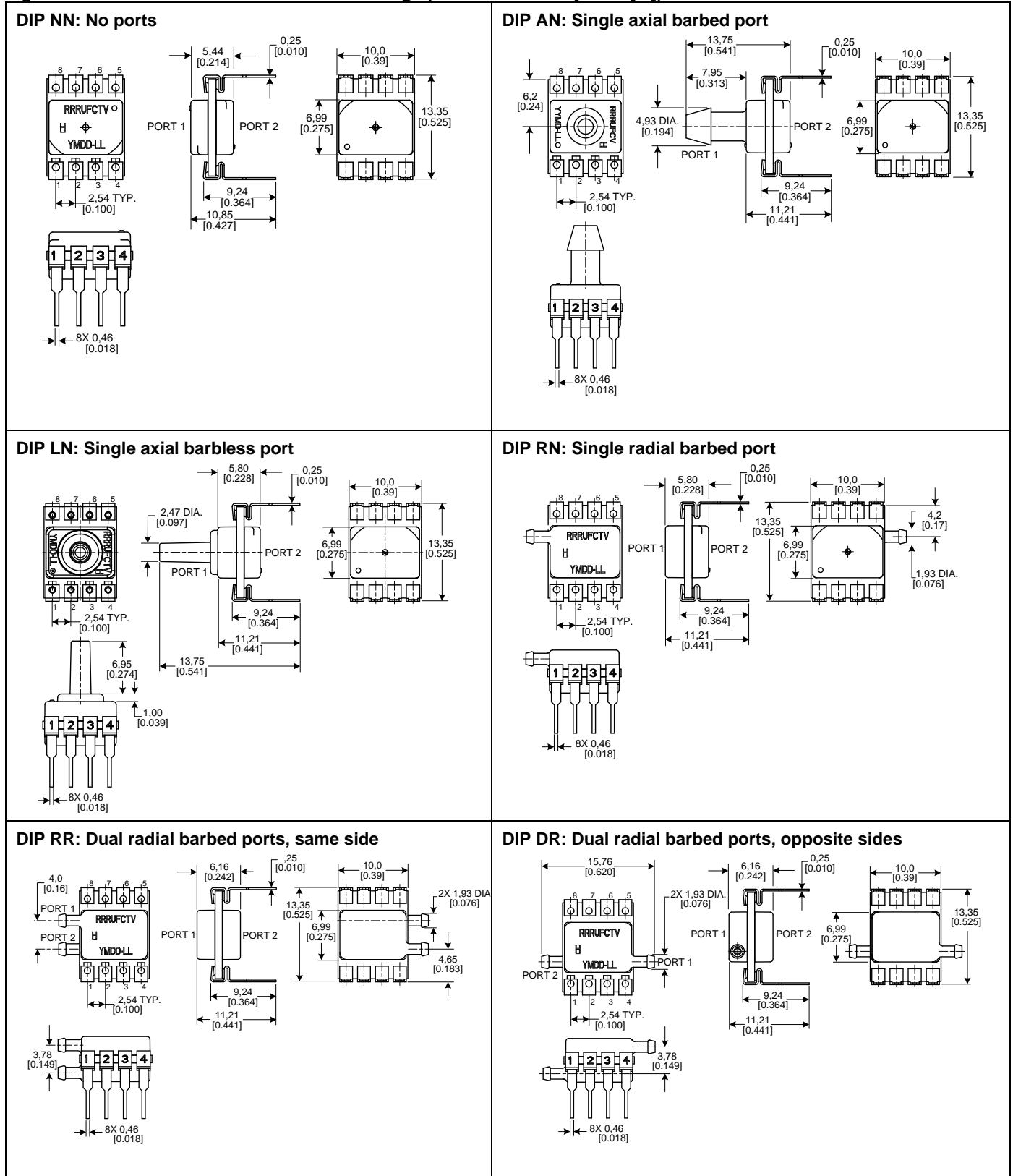

# TruStability® Silicon Pressure Sensors: SSC Series—Standard Accuracy

Figure 5. SMT Pressure Port Dimensional Drawings (For reference only: mm [in])

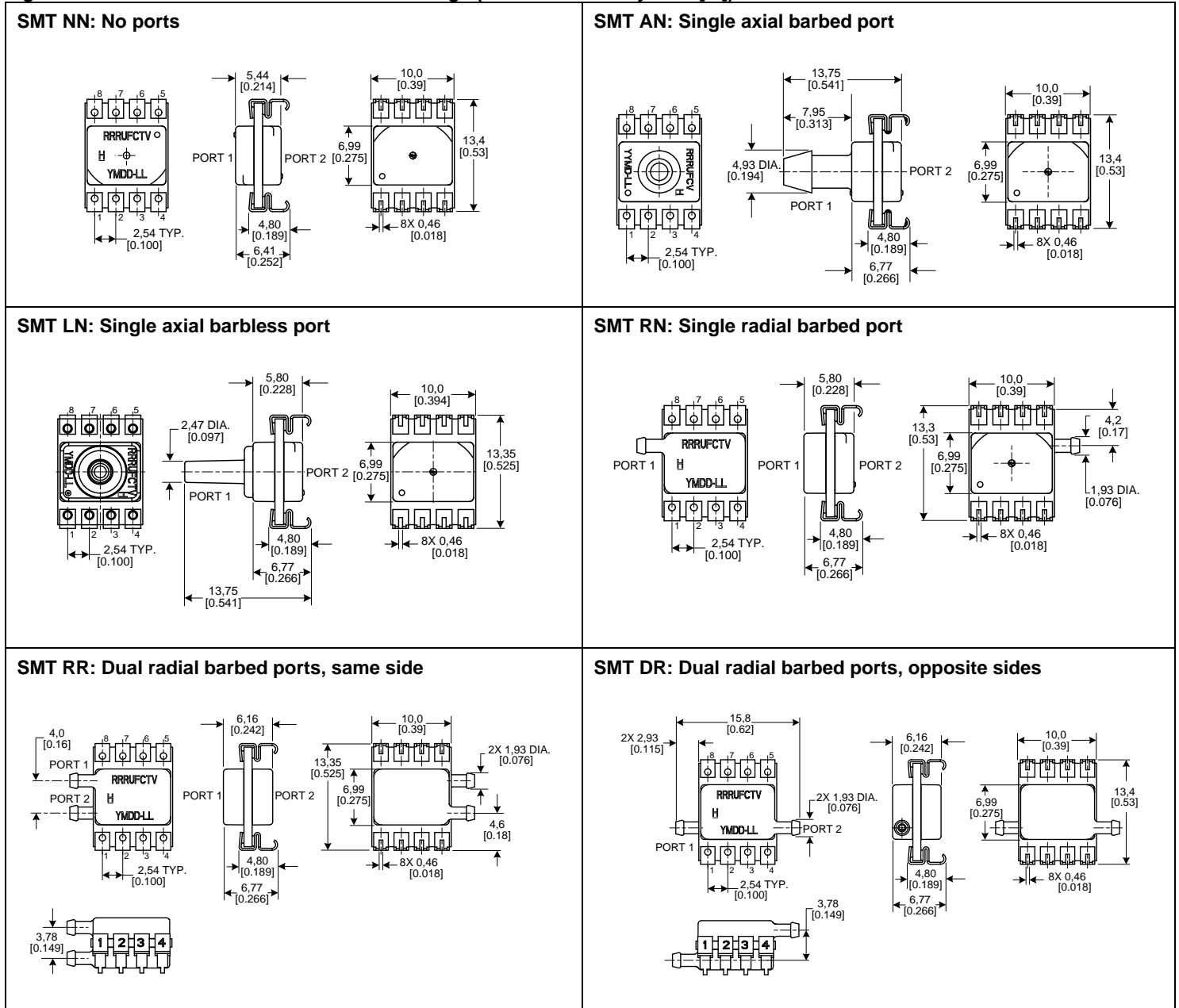



±2% Total Error Band, Digital Output, 1 psi to 150 psi (60 mbar to 10 bar)

Figure 6. SIP Package Dimensional Drawings (For reference only: mm [in])

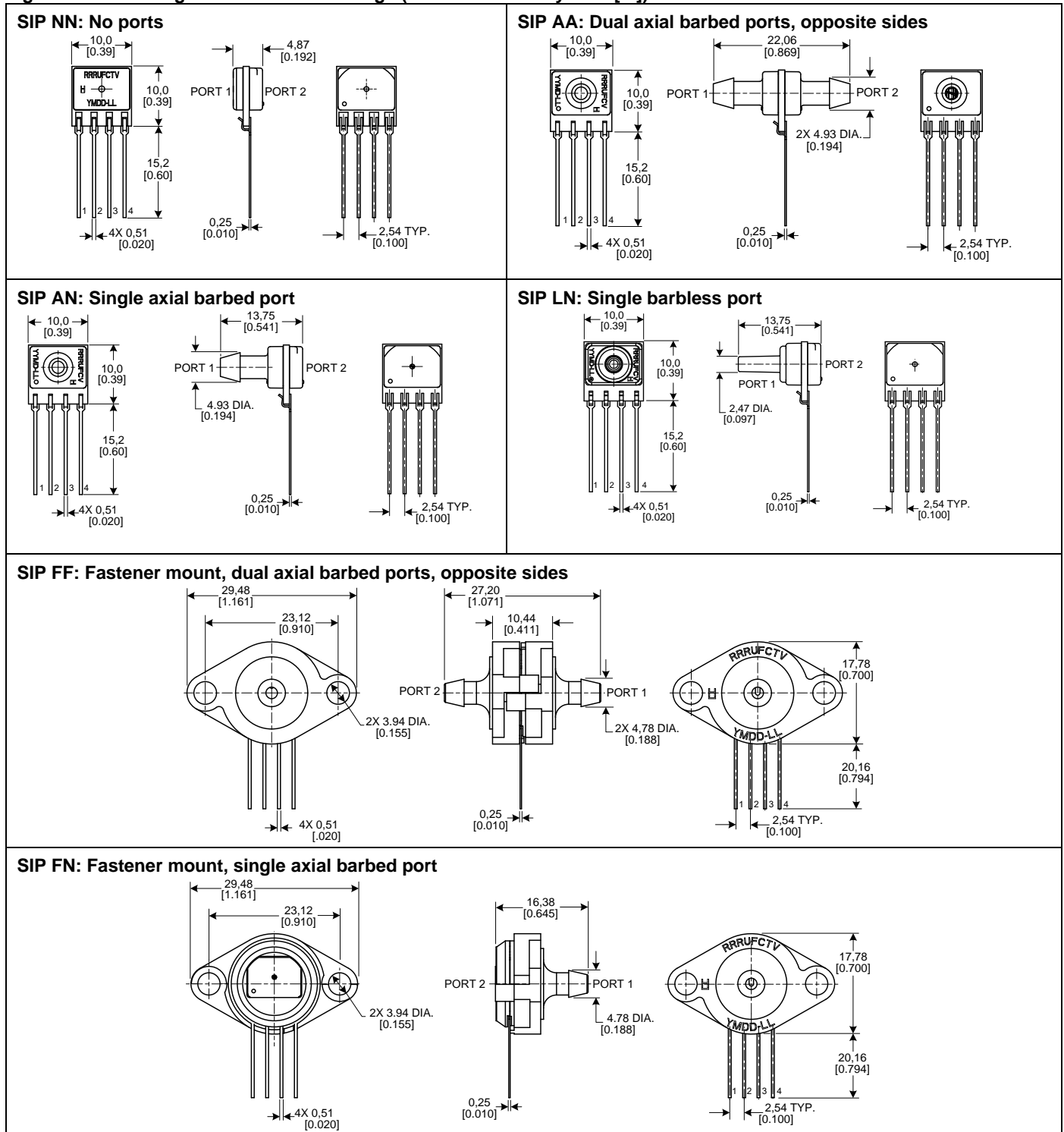

# TruStability® Silicon Pressure Sensors: SSC Series—Standard Accuracy

Figure 6. SIP Package Dimensional Drawings (continued)

**SIP GN: Ribbed fastener mount, single axial barbed port**



**SIP NB: Fastener mount, dual axial ports, same side**

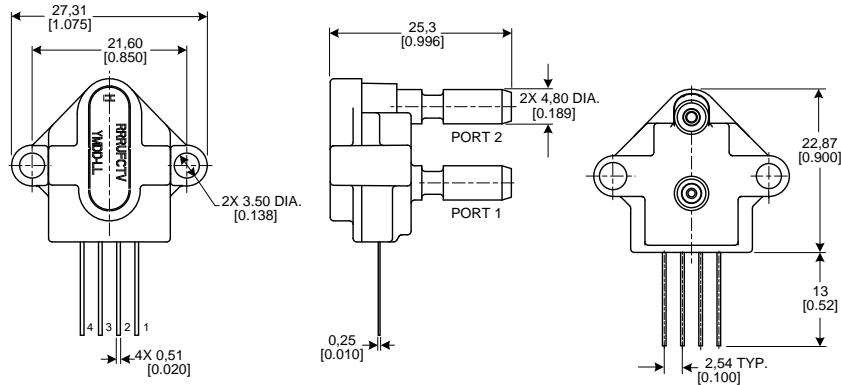

**SIP RN: Single radial barbed port**

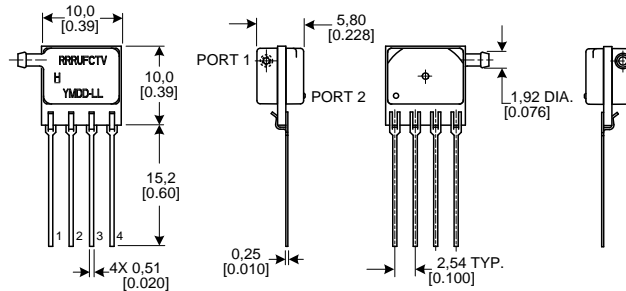

**SIP RR: Dual radial barbed ports, same side**

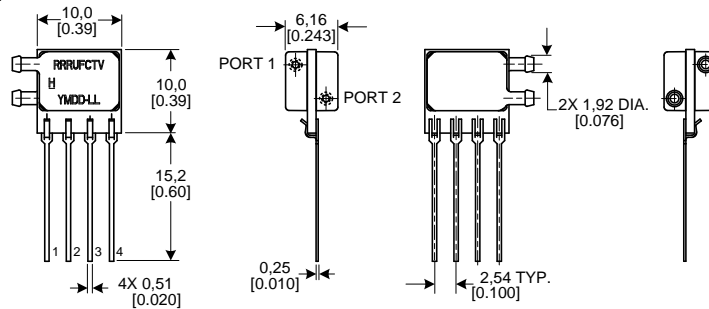

±2% Total Error Band, Digital Output, 1 psi to 150 psi (60 mbar to 10 bar)

Figure 6. SIP Package Dimensional Drawings (continued)

