

TruStability[®] Board Mount Pressure Sensors: SSC Series—Standard Accuracy

Amplified Compensated Analog Output,
 ± 2.5 mbar to ± 40 mbar
[± 1 inH₂O to ± 30 inH₂O]

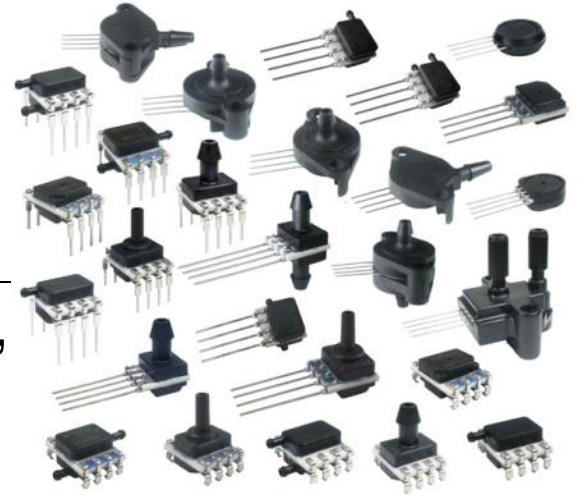

DESCRIPTION

The TruStability[®] Standard Accuracy Silicon Ceramic (SSC) Series is a piezoresistive silicon pressure sensor offering a ratiometric analog output for reading pressure over the specified full scale pressure span and temperature range.

The SSC Series is fully calibrated and temperature compensated for sensor offset, sensitivity, temperature effects, and non-linearity using an on-board Application Specific Integrated Circuit (ASIC). Calibrated output values for pressure are updated at approximately 1 kHz.

The SSC Series is calibrated over the temperature range of -20 °C to 85 °C [-4 °F to 185 °F]. The sensor is characterized for operation from a single power supply of either 3.3 Vdc or 5.0 Vdc.

These sensors measure differential and gage pressures. Differential versions allow application of pressure to either side of the sensing diaphragm. Gage versions are referenced to atmospheric pressure and provide an output proportional to pressure variations from atmosphere.

The SSC Series sensors are intended for use with non-corrosive, non-ionic working fluids. They are designed and manufactured according to standards in ISO 9001.

FEATURES AND BENEFITS (★=competitive differentiator)

- ★ **Proprietary Honeywell technology:** Combines high sensitivity with high overpressure and burst pressure—two performance factors that are difficult to achieve in the same product; this gives the customer more flexibility in sensor implementation and reduces the customer design requirements for protecting the sensor without sacrificing the ability to sense very small changes in pressure
- ★ **Industry-leading long-term stability:** Even after long-term use and thermal extremes, these sensors perform substantially better relative to stability than any other pressure sensor available in the industry today:
 - Minimizes system calibration needs
 - Maximizes system performance
 - Helps support system uptime by eliminating the need to service or replace the sensor during its application life
- ★ **Industry-leading Total Error Band (TEB):** Honeywell specifies TEB—the most comprehensive, clear, and meaningful measurement—that provides the sensor's true accuracy over a compensated range of -20 °C to 85 °C [-4 °F to 185 °F]:
 - Eliminates individually testing and calibrating every sensor, which can increase their manufacturing time and process
 - Supports system accuracy and warranty requirements
 - Helps to optimize system uptime
 - Provides excellent sensor interchangeability—there is minimal part-to-part variation in accuracy

TruStability® Board Mount Pressure Sensors: SSC Series—Standard Accuracy

- ★ **Industry-leading accuracy:** Extremely tight accuracy of $\pm 0.25\%$ FSS BFS (Full Scale Span Best Fit Straight Line):
 - Reduces software needs to correct system inaccuracies, minimizing system design time
 - Supports system accuracy and warranty requirements
 - Helps to optimize system uptime
- ★ **High burst pressures above 415 inH₂O (1034 mbar):**
 - Allows the sensor to endure a wide range of conditions while maintaining a high level of sensitivity which measures even the smallest change in pressure
 - Can simplify the design process
- ★ **High working pressure ranges above 135 inH₂O (336 mbar):** Allows ultra-low pressure sensors to be used continuously well above the calibrated pressure range
- ★ **Industry-leading flexibility**
 - Modular, flexible design with many package styles (with the same industry-leading stability), pressure ports, and options simplify integration into the device manufacturer's application
 - Available soon: single side liquid media option allows the end customer to use one port of the sensor with condensing humidity or directly with non-corrosive liquid media
- ★ **Repeatability:** Provides excellent repeatability, high accuracy and reliability under many demanding conditions
- ★ **Onboard signal conditioning:** Typically allows for the removal of signal conditioning components from the PCB, reducing costs and simplifying production processes
- ★ **Wide variety of pressure ranges:** From ± 2.5 mbar to ± 40 mbar [± 1 inH₂O to ± 30 inH₂O] provide support for many unique applications
- ★ **Meets IPC/JEDEC J-STD-020D.1 Moisture Sensitivity Level 1 requirements:**
 - Allows the customer to avoid the thermal and mechanical damage during solder reflow attachment and/or repair that lesser rated products would incur
- Allows unlimited floor life when stored as specified (≤ 30 °C/85 %RH), simplifying storage and reducing scrap
- ★ **Insensitive to mounting orientation:**
 - Allows customers to position the sensor in the most optimal point in the system, eliminating the concern for positional effects
 - Increases flexibility of use within the application
- ★ **Insensitive to vibration:** Reduces susceptibility to application-specific vibration that occurs with changes in pressure, minimizing inaccurate pressure readings
- ★ **Custom calibration:** Typically allows for the removal of additional components associated with signal conditioning from the PCB, reducing PCB size as well as costs often associated with those components (e.g., acquisition, inventory, assembly)
- ★ **Internal diagnostic functions:** Increases system reliability
- **Energy efficient:** Extremely low power consumption (less than 10 mW, typ.):
 - Reduces power consumption
 - Provides extended battery life
 - Promotes energy efficiency
- **Output:** Ratiometric analog; I²C- or SPI-compatible 14-bit digital output (min. 12-bit sensor resolution) available
- **Small size:** Miniature 10 mm x 10 mm [0.39 in x 0.39 in] package is very small when compared to most board mount pressure sensors:
 - Occupies less area on the PCB
 - Typically allows for easy placement on crowded PCBs or in small devices
- **RoHS compliant**
- **Protected by multiple global patents**

POTENTIAL APPLICATIONS

- **Medical:**
 - Ventilators
 - Anesthesia machines
 - Spirometers
 - Nebulizers
 - Hospital room air pressure
- **Industrial:**
 - VAV (Variable Air Volume) control
 - Static duct pressure
 - Clogged HVAC (Heating, Ventilation, and Air Conditioning) filter detection
 - HVAC transmitters
 - Indoor air quality

For more information on these potential applications, please see the application note [“Honeywell TruStability® Board Mount Pressure Sensors: HSC Series and SSC Series, Amplified Compensated Digital or Analog Output, \$\pm 2.5\$ mbar to \$\pm 40\$ mbar \[\$\pm 1\$ inH₂O to \$\pm 30\$ inH₂O\]”](#)

±2.5 mbar to ±40 mbar [± 1 inH₂O to ± 30 inH₂O]

Table 1. Absolute Maximum Ratings¹

Parameter	Min.	Max.	Unit
Supply voltage (V_{supply})	-0.3	6.0	Vdc
Voltage on any pin	-0.3	$V_{\text{supply}} + 0.3$	V
ESD susceptibility (human body model)	3	-	kV
Storage temperature	-40 [-40]	85 [185]	°C [°F]
Soldering time and temperature: Lead solder temperature (SIP, DIP) Peak reflow temperature (SMT)		4 s max. at 250 °C [482 °F] 15 s max. at 250 °C [482 °F]	

Table 2. Operating Specifications

Parameter	Min.	Typ.	Max.	Unit
Supply voltage (V_{supply}) ² : 3.3 Vdc 5.0 Vdc	3.27 4.95	3.3 ³ 5.0 ³	3.33 5.05	Vdc
<i>Sensors are either 3.3 Vdc or 5.0 Vdc based on listing selected.</i>				
Supply current: 3.3 Vdc supply 5.0 Vdc supply	- -	1.6 2	2.1 3	mA
Compensated temperature range ⁴	-20 [-4]	-	85 [185]	°C [°F]
Operating temperature range ⁵	-40 [-40]	-	85 [185]	°C [°F]
Startup time (power up to data ready)	-	-	5	ms
Response time	-	1	-	ms
Upper output clipping limit	-	-	97.5	V_{supply}
Lower output clipping limit	2.5	-	-	V_{supply}
Accuracy ⁶	-	-	±0.25	%FSS ⁸
Orientation sensitivity (± 1 g) ⁷	-	-	±0.15	%FSS
Output resolution	0.03	-	-	%FSS

TruStability® Board Mount Pressure Sensors: SSC Series—Standard Accuracy

Table 3. Environmental Specifications

Parameter	Characteristic
Humidity: Gases only (See “Options N and D” in Figure 1.) Liquid media (See “Options T and V” in Figure 1.)	0% to 95% RH, non-condensing 100% condensing or direct liquid media on Port 1
Vibration	MIL-STD-202F, Method 214, Condition F (20.7 g random)
Shock	MIL-STD-202F, Method 213B, Condition F
Life ⁹	1 million cycles to working pressure min. ¹⁰
Solder reflow	J-STD-020D.1, Moisture Sensitivity Level 1 (unlimited floor life when stored as specified (≤ 30 °C/85 %RH))

Table 4. Wetted Materials¹¹

Parameter	Port 1 (Pressure Port)	Port 2 (Reference Port)
Covers	high temperature polyamide	high temperature polyamide
Substrate	alumina ceramic	alumina ceramic
Adhesives	epoxy, silicone	epoxy, silicone
Electronic components	ceramic, glass, solder, silicon	silicon, glass, gold, solder

Notes:

1. Absolute maximum ratings are the extreme limits the device can withstand without damage to the product. Stresses above these ratings may cause permanent damage. Exposure to absolute maximum conditions for extended periods may degrade device reliability.
2. Ratiometricity of the sensor (the ability of the analog device to maintain performance parameters independent of supply voltage) is achieved when the supply voltage is within the operating specification range.
3. The sensor is not reverse polarity protected. Incorrect application of supply voltage or ground to the wrong pin may cause electrical failure.
4. The compensated temperature range is the temperature range over which the sensor will produce an output proportional to pressure within the specified performance limits.
5. The operating temperature range is the temperature range over which the sensor will produce an output proportional to pressure but may not remain within the specified performance limits.
6. Accuracy: The maximum deviation in output from a Best Fit Straight Line (BFSL) fitted to the output measured over the pressure range at 25 °C [77 °F]. Includes all errors due to pressure non-linearity, pressure hysteresis, and non-repeatability. (See Figure 3.)
7. Orientation sensitivity: The maximum change in offset of the sensor due to a change in position or orientation relative to Earth's gravitational field.
8. Full Scale Span (FSS): The algebraic difference between the output signal measured at the maximum (Pmax.) and minimum (Pmin.) limits of the pressure range. (See Figure 1 for ranges.)
9. Life may vary depending on specific application in which sensor is utilized. Contact Honeywell Sales and Service for Mean Time to Failure (MTTF) data.
10. Working Pressure: The maximum pressure that may be applied to any port of the sensor in continuous use. This pressure may be outside the operating pressure range limits (Pmin. to Pmax.) in which case the sensor may not provide a valid output until pressure is returned to within the operating pressure range. Tested to 1 million cycles, min. (See Figure 5.)
11. Contact Honeywell Sales and Service for detailed material information.

±2.5 mbar to ±40 mbar [±1 inH₂O to ±30 inH₂O]

Figure 1. Nomenclature and Order Guide

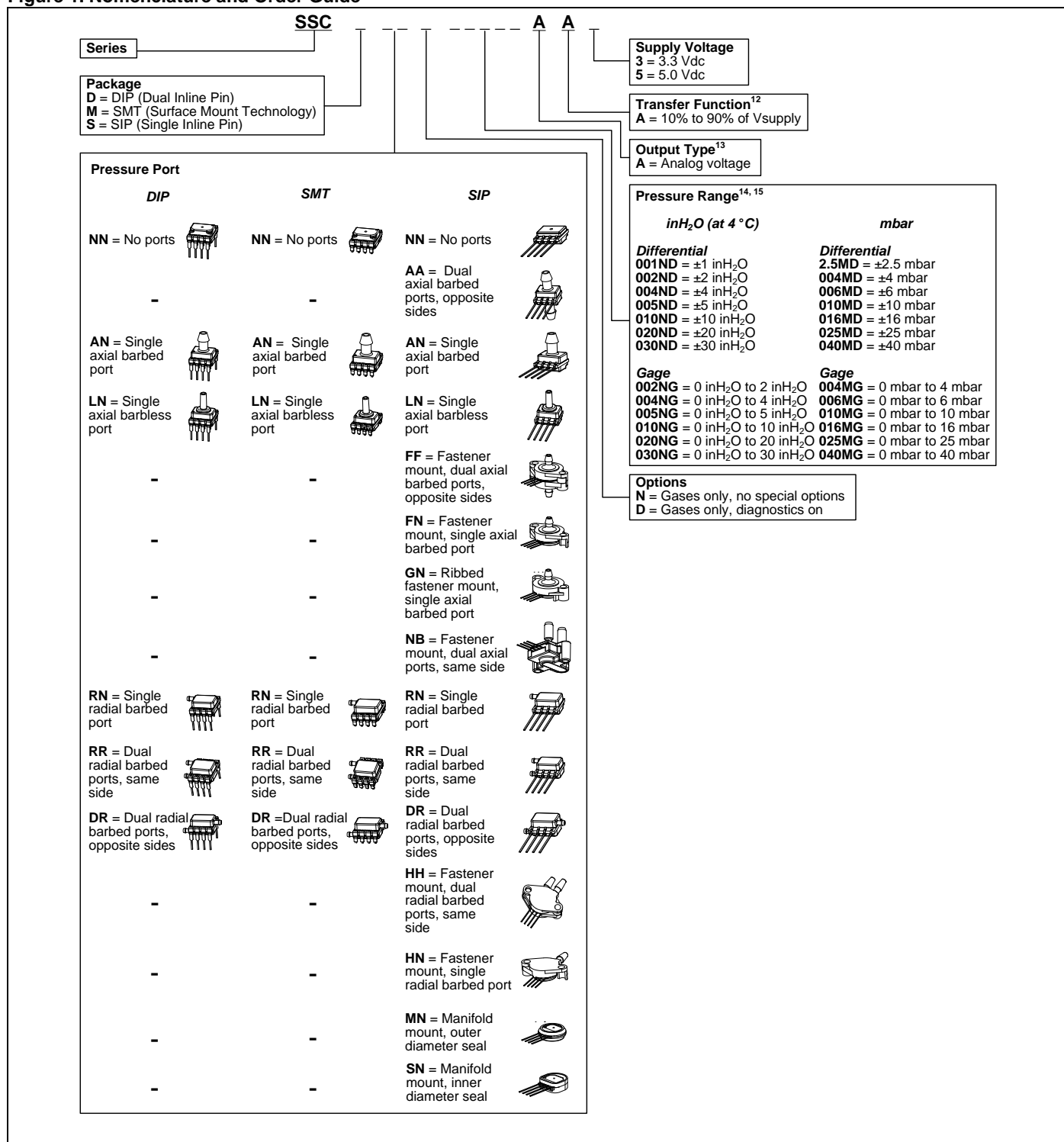

Notes:

- The transfer function limits define the output of the sensor at a given pressure input. By specifying P_{min.} and P_{max.}, the output at P_{min.} and transfer functions are available. Contact Honeywell Sales and Service for more information.
- Digital output is also available. Contact Honeywell Sales and Service for more information.
- Custom pressure ranges are available. Contact Honeywell Sales and Service for more information.
- See Table 5 for an explanation of sensor pressure types.

TruStability® Board Mount Pressure Sensors: SSC Series–Standard Accuracy

Figure 2. Completed Catalog Listing Example for SSCSANN010NGAA3

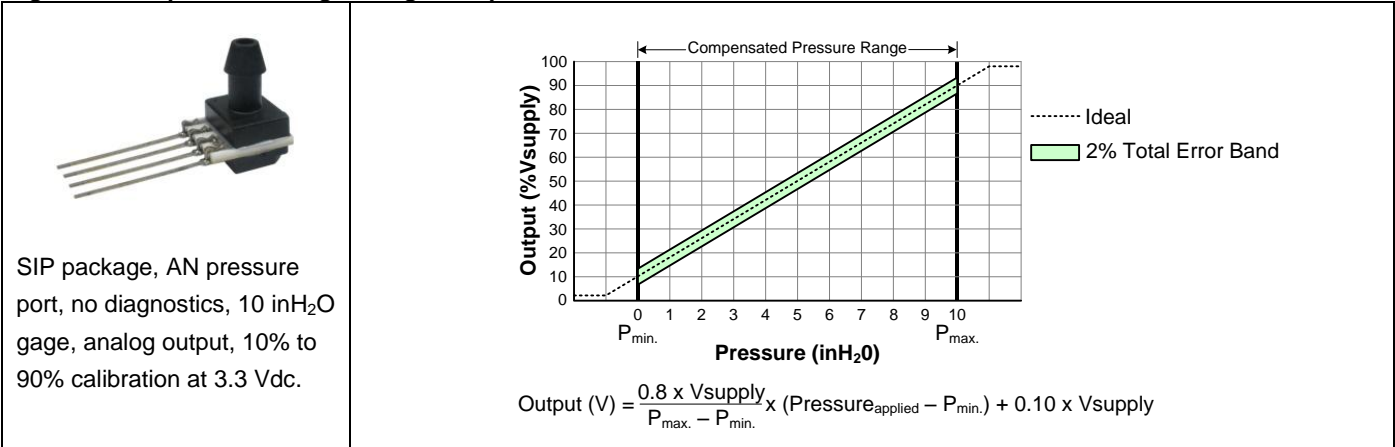

Table 5. Pressure Types

Pressure Type	Description
Differential	Output is proportional to the difference between the pressures applied to each port (Port 1 – Port 2). 50% point of transfer function set at Port 1 = Port 2.
Gage	Output is proportional to the difference between applied pressure and atmospheric (ambient) pressure. P _{min.} is set at atmospheric pressure.

Table 6. Pressure Range Specifications for ±1 inH₂O to ±30 inH₂O

Order Code (See Fig. 1)	Pressure Range		Total Error Band ¹⁶	Total Error Band after Auto-Zero ¹⁷	Long-term Stability (1000 hr, 25 °C [77 °F])	Working Pressure ¹⁰	Over-pressure ¹⁸	Burst Pressure ¹⁹	Common Mode Pressure ²⁰
	P _{min.}	P _{max.}							
Differential									
001ND	-1 inH ₂ O	1 inH ₂ O	±5 %FSS	±1.5 %FSS	±0.5 %FSS	135 inH ₂ O	270 inH ₂ O	415 inH ₂ O	1400 inH ₂ O
002ND	-2 inH ₂ O	2 inH ₂ O	±2.5 %FSS	±1 %FSS	±0.5 %FSS	135 inH ₂ O	270 inH ₂ O	415 inH ₂ O	1400 inH ₂ O
004ND	-4 inH ₂ O	4 inH ₂ O	±2 %FSS	±0.75 %FSS	±0.5 %FSS	150 inH ₂ O	300 inH ₂ O	500 inH ₂ O	2200 inH ₂ O
005ND	-5 inH ₂ O	5 inH ₂ O	±2 %FSS	±0.75 %FSS	±0.5 %FSS	150 inH ₂ O	300 inH ₂ O	500 inH ₂ O	2200 inH ₂ O
010ND	-10 inH ₂ O	10 inH ₂ O	±2 %FSS	±0.75 %FSS	±0.5 %FSS	175 inH ₂ O	350 inH ₂ O	550 inH ₂ O	4200 inH ₂ O
020ND	-20 inH ₂ O	20 inH ₂ O	±2 %FSS	±0.75 %FSS	±0.35 %FSS	175 inH ₂ O	350 inH ₂ O	550 inH ₂ O	4200 inH ₂ O
030ND	-30 inH ₂ O	30 inH ₂ O	±2 %FSS	±0.75 %FSS	±0.35 %FSS	175 inH ₂ O	350 inH ₂ O	550 inH ₂ O	4200 inH ₂ O
Gage									
002NG	0 inH ₂ O	2 inH ₂ O	±5 %FSS	±1.5 %FSS	±0.5 %FSS	135 inH ₂ O	270 inH ₂ O	415 inH ₂ O	1400 inH ₂ O
004NG	0 inH ₂ O	4 inH ₂ O	±2.5 %FSS	±1 %FSS	±0.5 %FSS	135 inH ₂ O	270 inH ₂ O	415 inH ₂ O	1400 inH ₂ O
005NG	0 inH ₂ O	5 inH ₂ O	±2.5 %FSS	±1 %FSS	±0.5 %FSS	135 inH ₂ O	270 inH ₂ O	415 inH ₂ O	1400 inH ₂ O
010NG	0 inH ₂ O	10 inH ₂ O	±2 %FSS	±0.75 %FSS	±0.5 %FSS	150 inH ₂ O	300 inH ₂ O	500 inH ₂ O	2200 inH ₂ O
020NG	0 inH ₂ O	20 inH ₂ O	±2 %FSS	±0.75 %FSS	±0.5 %FSS	175 inH ₂ O	350 inH ₂ O	550 inH ₂ O	4200 inH ₂ O
030NG	0 inH ₂ O	30 inH ₂ O	±2 %FSS	±0.75 %FSS	±0.35 %FSS	175 inH ₂ O	350 inH ₂ O	550 inH ₂ O	4200 inH ₂ O

±2.5 mbar to ±40 mbar [±1 inH₂O to ±30 inH₂O]

Table 7. Pressure Range Specifications for ±2.5 mbar to ±40 mbar

Order Code (See Fig. 1)	Pressure Range		Total Error Band ¹⁶	Total Error Band after Auto-Zero ¹⁷	Long-term Stability (1000 hr, 25 °C [77 °F])	Working Pressure ¹⁰	Over-pressure ¹⁸	Burst Pressure ¹⁹	Common Mode Pressure ²⁰
	P _{min.}	P _{max.}							
Differential									
2.5MD	-2.5 mbar	2.5 mbar	±5 %FSS	±1.5 %FSS	±0.5 %FSS	335 mbar	675 mbar	1000 mbar	3450 mbar
004MD	-4 mbar	4 mbar	±3.5 %FSS	±1.5 %FSS	±0.5 %FSS	335 mbar	675 mbar	1000 mbar	3450 mbar
006MD	-6 mbar	6 mbar	±2.5 %FSS	±1 %FSS	±0.5 %FSS	335 mbar	675 mbar	1000 mbar	3450 mbar
010MD	-10 mbar	10 mbar	±2 %FSS	±0.75 %FSS	±0.5 %FSS	375 mbar	750 mbar	1250 mbar	5450 mbar
016MD	-16 mbar	16 mbar	±2 %FSS	±0.75 %FSS	±0.5 %FSS	375 mbar	750 mbar	1250 mbar	5450 mbar
025MD	-25 mbar	25 mbar	±2 %FSS	±0.75 %FSS	±0.35 %FSS	435 mbar	850 mbar	1350 mbar	10450 mbar
040MD	-40 mbar	40 mbar	±2 %FSS	±0.75 %FSS	±0.35 %FSS	435 mbar	850 mbar	1350 mbar	10450 mbar
Gage									
004MG	0 mbar	4 mbar	±5 %FSS	±1.5 %FSS	±0.5 %FSS	335 mbar	675 mbar	1000 mbar	3450 mbar
006MG	0 mbar	6 mbar	±5 %FSS	±1.25 %FSS	±0.5 %FSS	335 mbar	675 mbar	1000 mbar	3450 mbar
010MG	0 mbar	10 mbar	±2.5 %FSS	±1 %FSS	±0.5 %FSS	335 mbar	675 mbar	1000 mbar	3450 mbar
016MG	0 mbar	16 mbar	±2.5 %FSS	±1 %FSS	±0.5 %FSS	335 mbar	675 mbar	1000 mbar	3450 mbar
025MG	0 mbar	25 mbar	±2 %FSS	±0.75 %FSS	±0.5 %FSS	375 mbar	750 mbar	1250 mbar	5450 mbar
040MG	0 mbar	40 mbar	±2 %FSS	±0.75 %FSS	±0.5 %FSS	375 mbar	750 mbar	1250 mbar	5450 mbar

Notes:

- 16. Total Error Band: The maximum deviation from the ideal transfer function over the entire compensated temperature and pressure range. Includes all errors due to offset, full scale span, pressure non-linearity, pressure hysteresis, repeatability, thermal effect on offset, thermal effect on span, and thermal hysteresis. (See Figures 3 and 4.)
- 17. Total Error Band After Auto-Zero: The maximum deviation from the ideal transfer function over the entire compensated pressure range at a constant temperature and supply voltage for a minimum of 24 hours after an auto-zero operation. Includes all errors due to full scale span, pressure non-linearity, pressure hysteresis, and thermal effect on span.
- 18. Overpressure: The absolute maximum rating for pressure which may safely be applied to the product for it to remain in specification once pressure is returned to the operating pressure range. Exposure to higher pressures may cause permanent damage to the product. Unless otherwise specified this applies to all available pressure ports at any temperature with the operating temperature range. Tested to 10,000 cycles, minimum. (See Figure 5.)
- 19. Burst Pressure: The maximum pressure that may be applied to any port of the product without causing escape of pressure media. Product should not be expected to function after exposure to any pressure beyond the burst pressure. (See Figure 5.)
- 20. Common Mode Pressure: The maximum pressure that can be applied simultaneously to both ports of a differential pressure sensor without causing changes in specified performance.

Table 8. Pinout for SMT and DIP Packages

Output Type	Pin 1	Pin 2	Pin 3	Pin 4	Pin 5	Pin 6	Pin 7	Pin 8
analog	NC	V _{supply}	OUTPUT+	GND	NC	NC	NC	NC

Table 9. Pinout for SIP Package

Output Type	Pin 1	Pin 2	Pin 3	Pin 4
analog	NC	V _{supply}	OUTPUT+	GND

TruStability® Board Mount Pressure Sensors: SSC Series—Standard Accuracy

Figure 3. Total Error Band Explanation

Total Error Band should not be confused with accuracy, which is actually a component of Total Error Band, as shown to the right.

Many competitors simply specify the accuracy of their device; however, the specification may exclude errors, or may be calculated over a very narrow range, at only one point in the range, or at their absolute best accuracy level. It is then up to the customer to calibrate the device to make sure it has the accuracy needed for the life of the application.

Honeywell provides the Total Error Band to its customers so that they can implement the TruStability® sensors quickly and easily without having to calculate the effects of individual errors that might be encountered in their application.

All TruStability® products are designed to remain within Total Error Band after exposure to the environmental conditions in Table 3, including the solder reflow process.

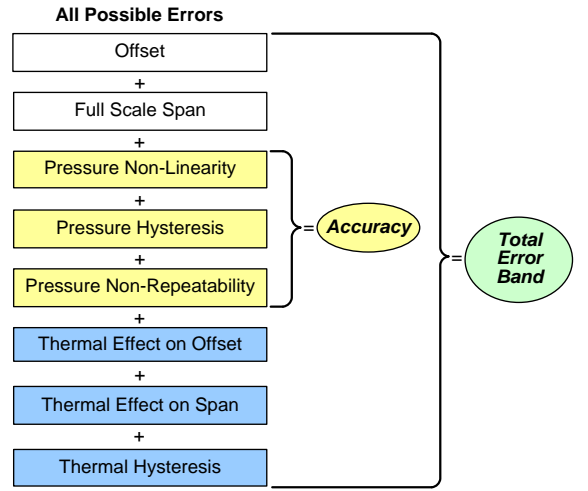

Figure 4. SSC Series Total Error Band Values for Full Scale Span Pressure Ranges

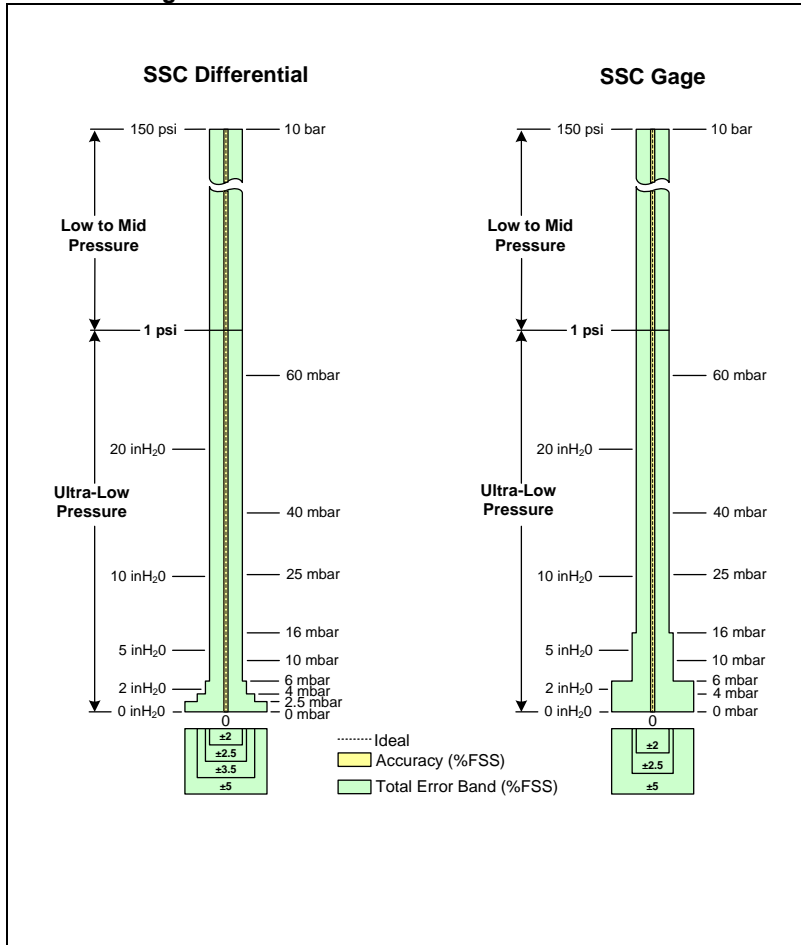
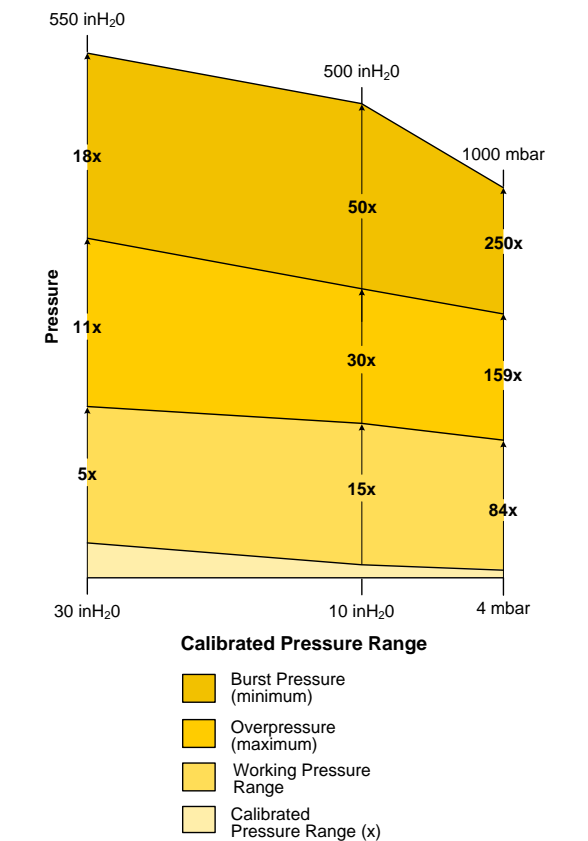

Figure 5. Calibrated Pressure Range, Working Pressure, Overpressure and Burst Pressure Relationship

The graphic below shows the relationship of the four pressure types at three locations: 30 inH₂O, 10 inH₂O and 4 mbar.



± 2.5 mbar to ± 40 mbar [± 1 inH₂O to ± 30 inH₂O]

Figure 6. DIP Pressure Port Dimensional Drawings (For reference only: mm [in])

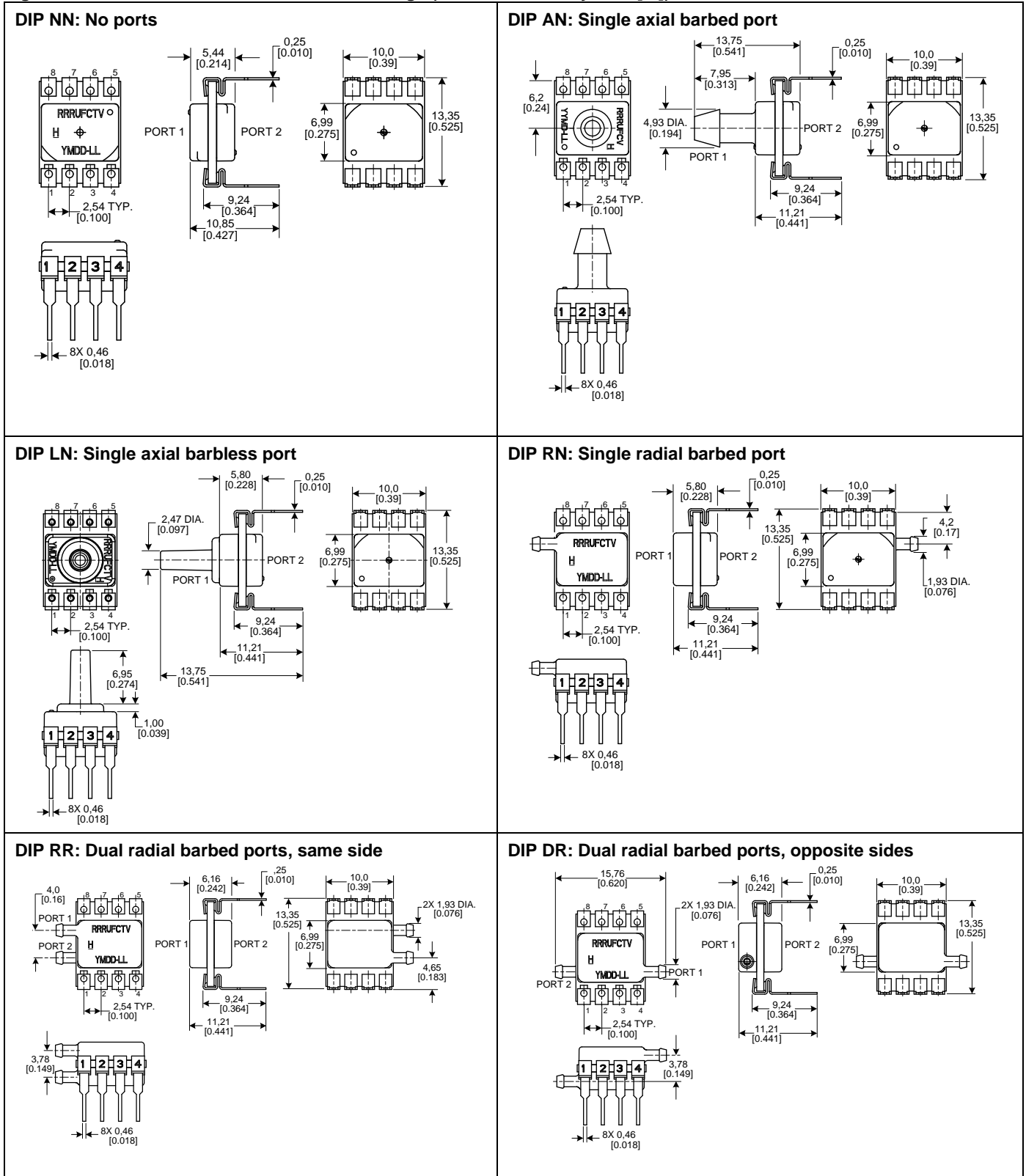

TruStability® Board Mount Pressure Sensors: SSC Series—Standard Accuracy

Figure 7. SMT Pressure Port Dimensional Drawings (For reference only: mm [in])

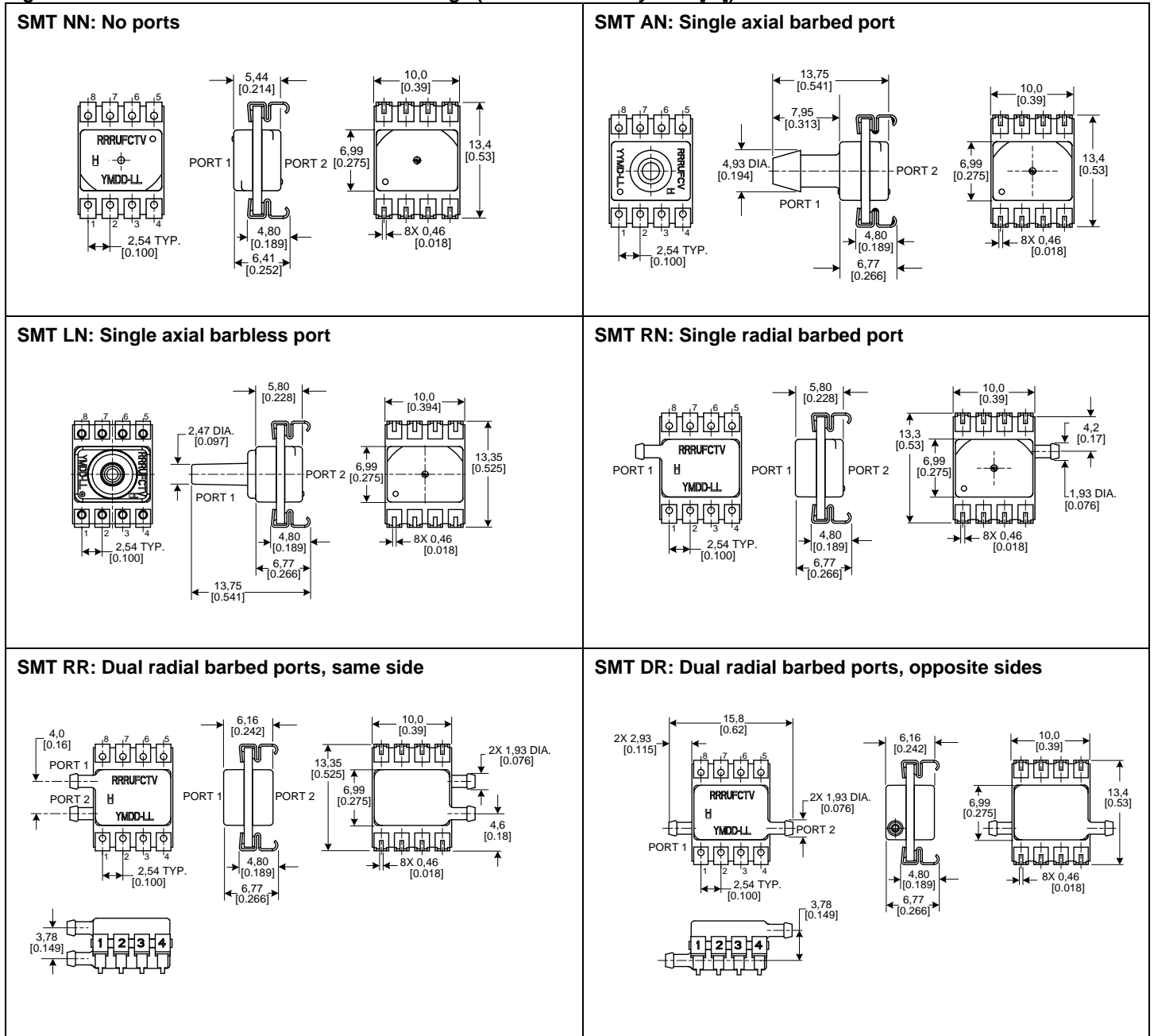

± 2.5 mbar to ± 40 mbar [± 1 inH₂O to ± 30 inH₂O]

Figure 8. SIP Package Dimensional Drawings (For reference only: mm [in])

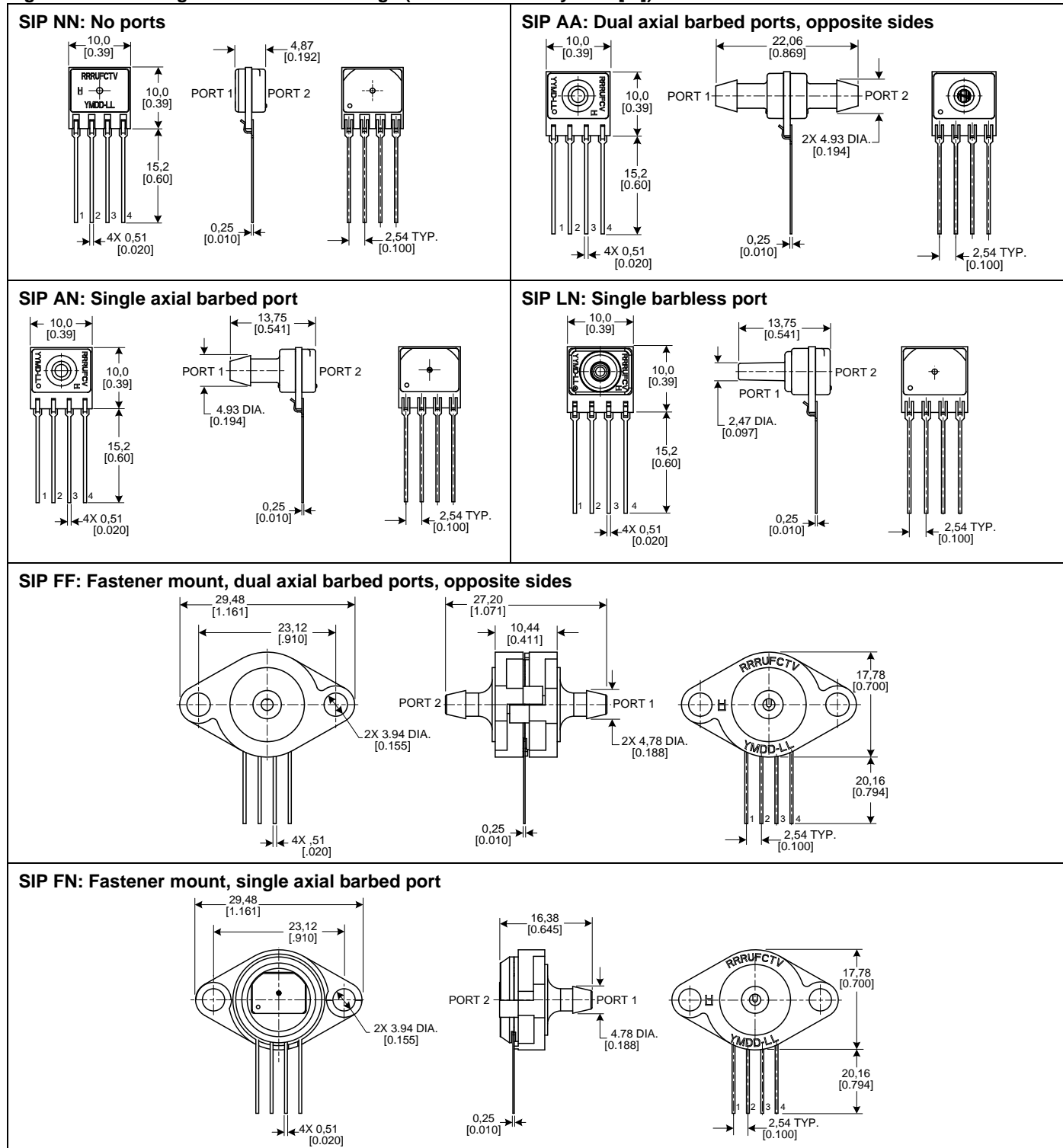

TruStability® Board Mount Pressure Sensors: SSC Series—Standard Accuracy

Figure 8. SIP Package Dimensional Drawings (continued)

SIP GN: Ribbed fastener mount, single axial barbed port

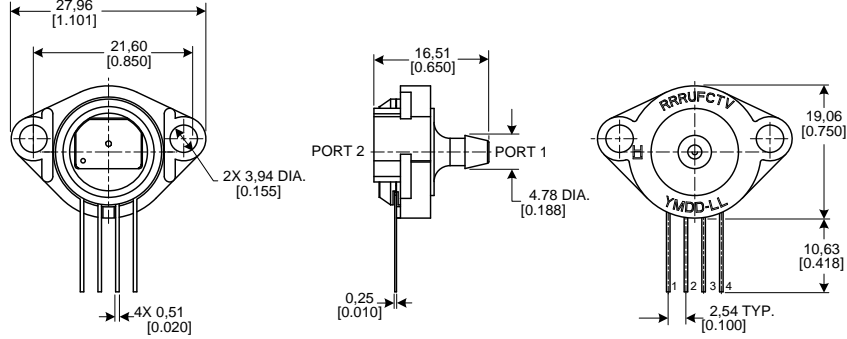

SIP NB: Fastener mount, dual axial ports, same side

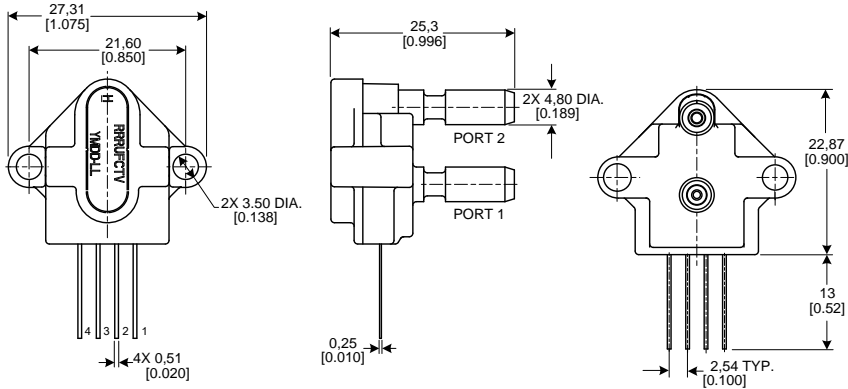

SIP RN: Single radial barbed port

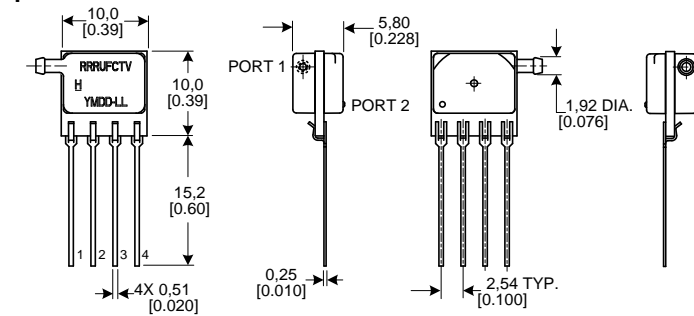

SIP RR: Dual radial barbed ports, same side

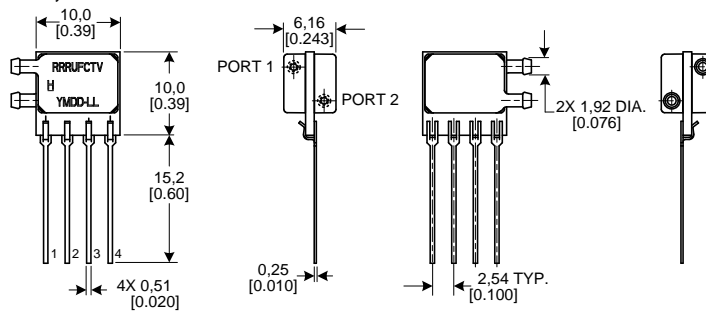

± 2.5 mbar to ± 40 mbar [± 1 inH₂O to ± 30 inH₂O]

Figure 8. SIP Package Dimensional Drawings (continued)

