

Evaluation kit for the LED1202 12-channel low quiescent current LED driver

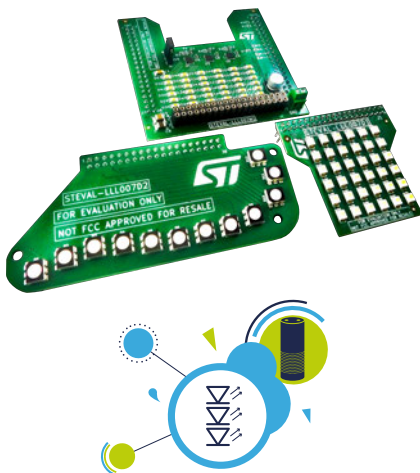

Features

- 3x LED1202 12-channel low quiescent current LED drivers embedded on main board
- Can immediately drive 36 white LEDs available on main board, to help you get started
- Includes additional panel boards to let you expand your development:
 - 1 with 36 white LEDs
 - 1 with 12 RGB LEDs
- Designed for use with NUCLEO-L073RZ development platform running the STSW-LLL007FW firmware.
- E5V connector to supply STM32 Nucleo board and additional panels
- Supplied with a range of default patterns
- GUI for advanced driver configuration and customized pattern generation
- CE Certified
- RoHS and China RoHS compliant
- WEEE compliant (2012/19/UE RAEE II)

Description

The STEVAL-LLL007V1 kit consists of the STEVAL-LLL007M1 main board and the STEVAL-LLL007D1 and STEVAL-LLL007D2 panel boards.

To help you evaluate all the features of the [LED1202](#) driver, you can connect the main board to a NUCLEO-L073RZ development platform running the STSW-LLL007FW firmware, which comes with pre-configured random and wave patterns for use in standalone mode.

You can even develop your own pattern sequences by connecting the Nucleo platform to a PC running a dedicated GUI program, which also gives you access to all the LED driver settings.

To achieve the maximum luminosity, you need to supply the STEVAL-LLL007D1 panel board and the STEVAL-LLL007D2 panel board with an external power source via the J13 connector on the STEVAL-LLL007M1 board.

Product summary	
12-channel low quiescent current LED driver	LED1202
Main board with LED1202 driver and 36 white LEDs	STEVAL-LLL007M1 (not available separately)
Panel board with 36 white LEDs	STEVAL-LLL007D1 (not available separately)
Panel board with 12 RGB LEDs	STEVAL-LLL007D2 (not available separately)

1 Block diagrams

Figure 1. STEVAL-LLL007V1 block diagram

Kit consists of:

- STEVAL-LLL007M1 main board
- STEVAL-LLL007D1 panel board with 36 white LEDs
- STEVAL-LLL007D2 panel board with 12 RGB LEDs

The STEVAL-LLL007V1 can be connected to an STM32 Nucleo board for programming and debugging purposes

You can connect your own custom LED board through the same connector used to connect the panel boards with the main board

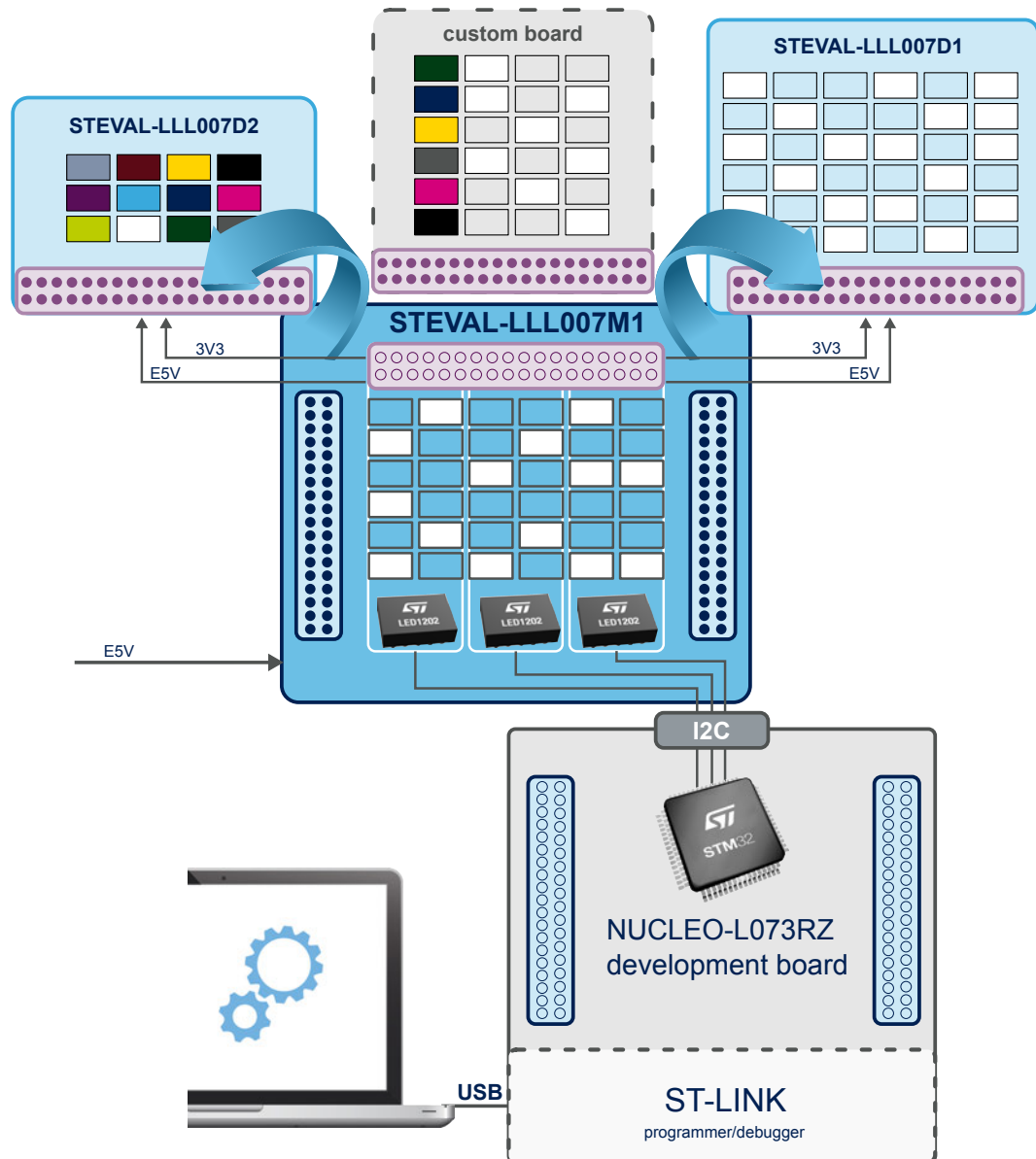

2 Schematic diagrams

Figure 2. STEVAL-LLL007M1 circuit schematic

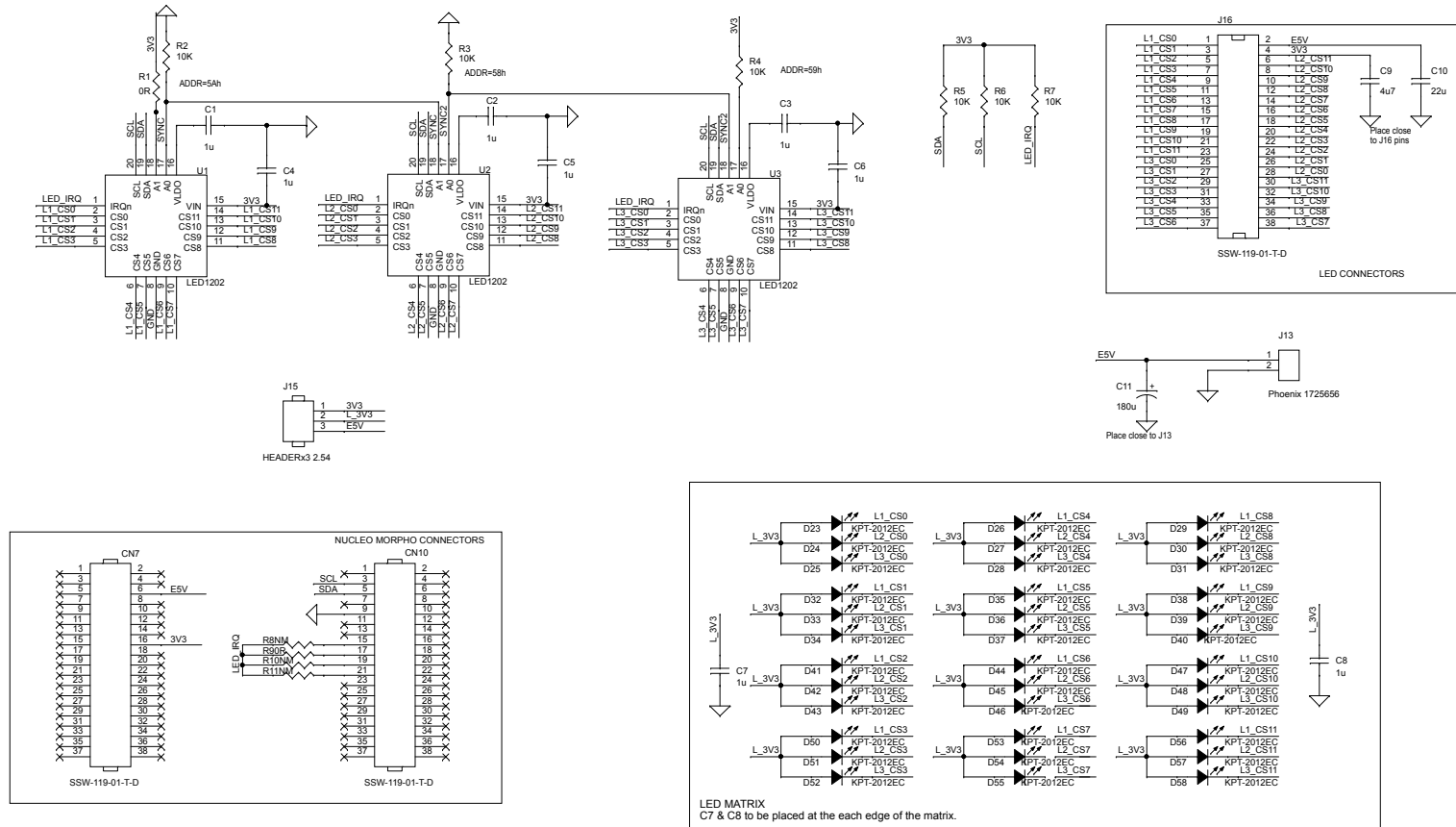
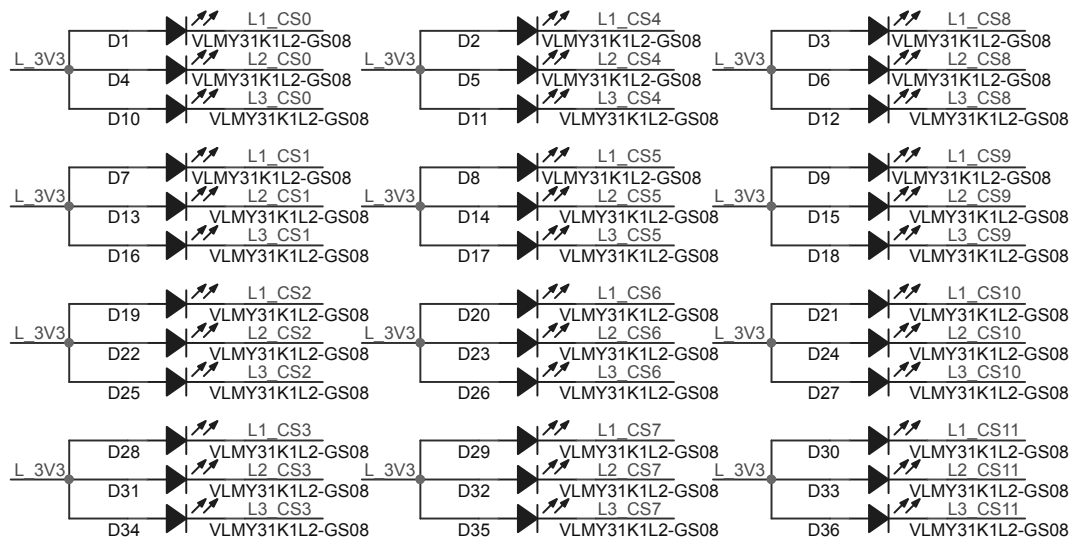

Figure 3. STEVAL-LLL007D1 circuit schematic



J1

L1_CS0	1	2	L_3V3
L1_CS1	3	4	
L1_CS2	5	6	× L3_CS11
L1_CS3	7	8	L3_CS10
L1_CS4	9	10	L3_CS9
L1_CS5	11	12	L3_CS8
L1_CS6	13	14	L3_CS7
L1_CS7	15	16	L3_CS6
L1_CS8	17	18	L3_CS5
L1_CS9	19	20	L3_CS4
L1_CS10	21	22	L3_CS3
L1_CS11	23	24	L3_CS2
L2_CS0	25	26	L3_CS1
L2_CS1	27	28	L3_CS0
L2_CS2	29	30	L2_CS11
L2_CS3	31	32	L2_CS10
L2_CS4	33	34	L2_CS9
L2_CS5	35	36	L2_CS8
L2_CS6	37	38	L2_CS7

header 2 rows - pitch 2.54



Figure 4. STEVAL-LLL007D2 circuit schematic

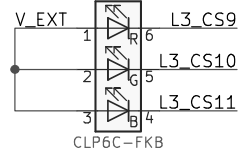
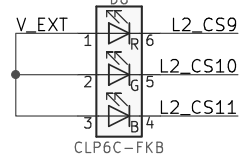
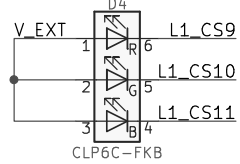
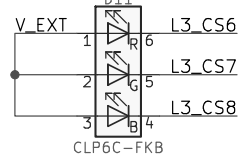
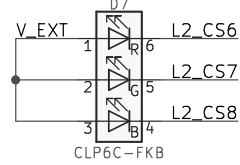
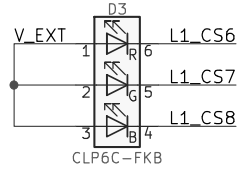
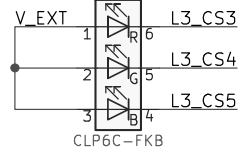
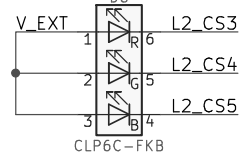
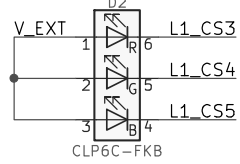
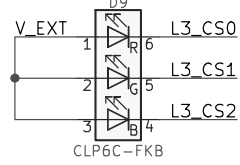
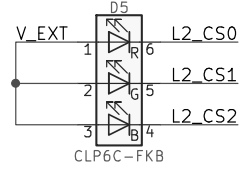
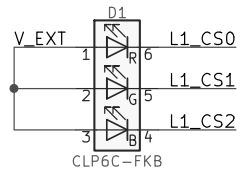

L1_CS0	1	J1	2	V_EXT
L1_CS1	3	J1	4	
L1_CS2	5	J1	6	L3_CS11
L1_CS3	7	J1	8	L3_CS10
L1_CS4	9	J1	10	L3_CS9
L1_CS5	11	J1	12	L3_CS8
L1_CS6	13	J1	14	L3_CS7
L1_CS7	15	J1	16	L3_CS6
L1_CS8	17	J1	18	L3_CS5
L1_CS9	19	J1	20	L3_CS4
L1_CS10	21	J1	22	L3_CS3
L1_CS11	23	J1	24	L3_CS2
L2_CS0	25	J1	26	L3_CS1
L2_CS1	27	J1	28	L3_CS0
L2_CS2	29	J1	30	L2_CS11
L2_CS3	31	J1	32	L2_CS10
L2_CS4	33	J1	34	L2_CS9
L2_CS5	35	J1	36	L2_CS8
L2_CS6	37	J1	38	L2_CS7

TSW-119-14-T-D



Revision history

Table 1. Document revision history

Date	Version	Changes
07-Mar-2019	1	Initial release.