

## Trench gate field-stop IGBT, M series 650 V, 10 A low-loss in TO-220FP package

Datasheet - production data

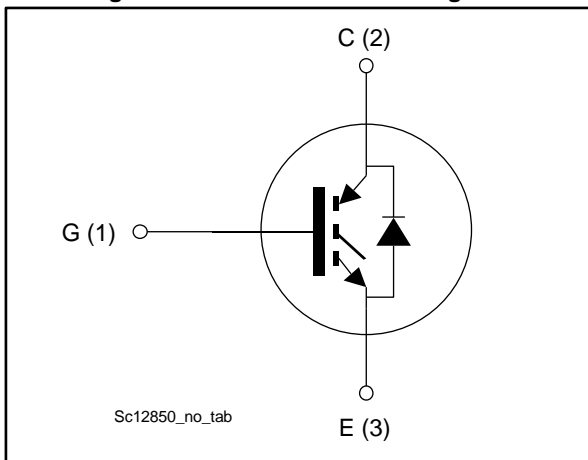

Figure 1: Internal schematic diagram



### Features

- 6  $\mu$ s of short-circuit withstand time
- $V_{CE(sat)} = 1.55$  V (typ.) @  $I_c = 10$  A
- Tight parameter distribution
- Safer paralleling
- Positive  $V_{CE(sat)}$  temperature coefficient
- Low thermal resistance
- Soft and very fast recovery antiparallel diode
- Maximum junction temperature:  $T_J = 175$  °C

### Applications

- Motor control
- UPS
- PFC
- General purpose inverter

### Description

This device is an IGBT developed using an advanced proprietary trench gate field-stop structure. The device is part of the M series IGBTs, which represent an optimal balance between inverter system performance and efficiency where low-loss and short-circuit functionality are essential. Furthermore, the positive  $V_{CE(sat)}$  temperature coefficient and tight parameter distribution result in safer paralleling operation.

Table 1: Device summary

Order code	Marking	Package	Packing
STGF10M65DF2	G10M65DF2	TO-220FP	Tube

---

## Contents

<b>1</b>	<b>Electrical ratings .....</b>	<b>3</b>
<b>2</b>	<b>Electrical characteristics .....</b>	<b>4</b>
	2.1 Electrical characteristics (curves) .....	6
<b>3</b>	<b>Test circuits .....</b>	<b>12</b>
<b>4</b>	<b>Package information .....</b>	<b>13</b>
	4.1 TO-220FP package information .....	14
<b>5</b>	<b>Revision history .....</b>	<b>16</b>

# 1 Electrical ratings

Table 2: Absolute maximum ratings

Symbol	Parameter	Value	Unit
V <sub>CES</sub>	Collector-emitter voltage (V <sub>GE</sub> = 0 V)	650	V
I <sub>C</sub> <sup>(1)</sup>	Continuous collector current at T <sub>C</sub> = 25 °C	20	A
I <sub>C</sub> <sup>(1)</sup>	Continuous collector current at T <sub>C</sub> = 100 °C	10	A
I <sub>CP</sub> <sup>(2)</sup>	Pulsed collector current	40	A
V <sub>GE</sub>	Gate-emitter voltage	±20	V
I <sub>F</sub> <sup>(1)</sup>	Continuous forward current at T <sub>C</sub> = 25 °C	20	A
I <sub>F</sub> <sup>(1)</sup>	Continuous forward current at T <sub>C</sub> = 100 °C	10	A
I <sub>FP</sub> <sup>(2)</sup>	Pulsed forward current	40	A
V <sub>ISO</sub>	Insulation withstand voltage (RMS) from all three leads to external heat sink (t = 1 s, T <sub>C</sub> = 25 °C)	2.5	kV
P <sub>TOT</sub>	Total dissipation at T <sub>C</sub> = 25 °C	30	W
T <sub>STG</sub>	Storage temperature range	- 55 to 150	°C
T <sub>J</sub>	Operating junction temperature range	- 55 to 175	°C

**Notes:**

<sup>(1)</sup>Limited by maximum junction temperature.

<sup>(2)</sup>Pulse width limited by maximum junction temperature.

Table 3: Thermal data

Symbol	Parameter	Value	Unit
R <sub>thJC</sub>	Thermal resistance junction-case IGBT	5	°C/W
R <sub>thJC</sub>	Thermal resistance junction-case diode	6.25	°C/W
R <sub>thJA</sub>	Thermal resistance junction-ambient	62.5	°C/W

## 2 Electrical characteristics

$T_C = 25\text{ °C}$  unless otherwise specified

**Table 4: Static characteristics**

Symbol	Parameter	Test conditions	Min.	Typ.	Max.	Unit
$V_{(BR)CES}$	Collector-emitter breakdown voltage	$V_{GE} = 0\text{ V}$ , $I_C = 250\text{ }\mu\text{A}$	650			V
$V_{CE(sat)}$	Collector-emitter saturation voltage	$V_{GE} = 15\text{ V}$ , $I_C = 10\text{ A}$		1.55	2.0	V
		$V_{GE} = 15\text{ V}$ , $I_C = 15\text{ A}$		1.8		
		$V_{GE} = 15\text{ V}$ , $I_C = 10\text{ A}$ , $T_J = 125\text{ °C}$		1.9		
		$V_{GE} = 15\text{ V}$ , $I_C = 10\text{ A}$ , $T_J = 175\text{ °C}$		2.1		
$V_F$	Forward on-voltage	$I_F = 10\text{ A}$		1.5	2.25	V
		$I_F = 10\text{ A}$ , $T_J = 125\text{ °C}$		1.3		
		$I_F = 10\text{ A}$ , $T_J = 175\text{ °C}$		1.2		
$V_{GE(th)}$	Gate threshold voltage	$V_{CE} = V_{GE}$ , $I_C = 250\text{ }\mu\text{A}$	5	6	7	V
$I_{CES}$	Collector cut-off current	$V_{GE} = 0\text{ V}$ , $V_{CE} = 650\text{ V}$			25	$\mu\text{A}$
$I_{GES}$	Gate-emitter leakage current	$V_{CE} = 0\text{ V}$ , $V_{GE} = \pm 20\text{ V}$			$\pm 250$	$\mu\text{A}$

**Table 5: Dynamic characteristics**

Symbol	Parameter	Test conditions	Min.	Typ.	Max.	Unit
$C_{ies}$	Input capacitance	$V_{CE} = 25\text{ V}$ , $f = 1\text{ MHz}$ , $V_{GE} = 0\text{ V}$	-	840	-	pF
$C_{oes}$	Output capacitance		-	63	-	
$C_{res}$	Reverse transfer capacitance		-	16	-	
$Q_g$	Total gate charge	$V_{CC} = 520\text{ V}$ , $I_C = 10\text{ A}$ , $V_{GE} = 0\text{ to }15\text{ V}$ (see <a href="#">Figure 30: "Gate charge test circuit"</a> )	-	28	-	nC
$Q_{ge}$	Gate-emitter charge		-	6	-	
$Q_{gc}$	Gate-collector charge		-	12	-	

Table 6: IGBT switching characteristics (inductive load)

Symbol	Parameter	Test conditions	Min.	Typ.	Max.	Unit
$t_{d(on)}$	Turn-on delay time	$V_{CE} = 400\text{ V}$ , $I_C = 10\text{ A}$ , $V_{GE} = 15\text{ V}$ , $R_G = 22\ \Omega$ (see <a href="#">Figure 29: "Test circuit for inductive load switching"</a> )		19	-	ns
$t_r$	Current rise time			7.4	-	ns
$(di/dt)_{on}$	Turn-on current slope			1086	-	A/ $\mu$ s
$t_{d(off)}$	Turn-off-delay time			91	-	ns
$t_f$	Current fall time			92	-	ns
$E_{on}^{(1)}$	Turn-on switching energy			0.12	-	mJ
$E_{off}^{(2)}$	Turn-off switching energy			0.27	-	mJ
$E_{ts}$	Total switching energy			0.39	-	mJ
$t_{d(on)}$	Turn-on delay time	$V_{CE} = 400\text{ V}$ , $I_C = 10\text{ A}$ , $V_{GE} = 15\text{ V}$ , $R_G = 22\ \Omega$ $T_J = 175\text{ }^\circ\text{C}$ (see <a href="#">Figure 29: "Test circuit for inductive load switching"</a> )		18	-	ns
$t_r$	Current rise time			9	-	ns
$(di/dt)_{on}$	Turn-on current slope			890	-	A/ $\mu$ s
$t_{d(off)}$	Turn-off-delay time			90	-	ns
$t_f$	Current fall time			170	-	ns
$E_{on}^{(1)}$	Turn-on switching energy			0.26	-	mJ
$E_{off}^{(2)}$	Turn-off switching energy			0.4	-	mJ
$E_{ts}$	Total switching energy			0.66	-	mJ
$t_{sc}$	Short-circuit withstand time	$V_{CC} \leq 400\text{ V}$ , $V_{GE} = 13\text{ V}$ , $T_{Jstart} = 150\text{ }^\circ\text{C}$	10		-	$\mu$ s
		$V_{CC} \leq 400\text{ V}$ , $V_{GE} = 15\text{ V}$ , $T_{Jstart} = 150\text{ }^\circ\text{C}$	6		-	$\mu$ s

**Notes:**

(1)Including the reverse recovery of the diode.

(2)Including the tail of the collector current.

Table 7: Diode switching characteristics (inductive load)

Symbol	Parameter	Test conditions	Min.	Typ.	Max.	Unit
$t_{rr}$	Reverse recovery time	$I_F = 10\text{ A}$ , $V_R = 400\text{ V}$ , $V_{GE} = 15\text{ V}$ , $di/dt = 1000\text{ A}/\mu\text{s}$ (see <a href="#">Figure 29: "Test circuit for inductive load switching"</a> )	-	96	-	ns
$Q_{rr}$	Reverse recovery charge		-	373	-	nC
$I_{rrm}$	Reverse recovery current		-	13	-	A
$dl_{rr}/dt$	Peak rate of fall of reverse recovery current during $t_b$		-	661	-	A/ $\mu$ s
$E_{rr}$	Reverse recovery energy		-	52	-	$\mu$ J
$t_{rr}$	Reverse recovery time	$I_F = 10\text{ A}$ , $V_R = 400\text{ V}$ , $V_{GE} = 15\text{ V}$ , $di/dt = 1000\text{ A}/\mu\text{s}$ , $T_J = 175\text{ }^\circ\text{C}$ (see <a href="#">Figure 29: "Test circuit for inductive load switching"</a> )	-	201	-	ns
$Q_{rr}$	Reverse recovery charge		-	1352	-	nC
$I_{rrm}$	Reverse recovery current		-	19	-	A
$dl_{rr}/dt$	Peak rate of fall of reverse recovery current during $t_b$		-	405	-	A/ $\mu$ s
$E_{rr}$	Reverse recovery energy		-	150	-	$\mu$ J

## 2.1 Electrical characteristics (curves)

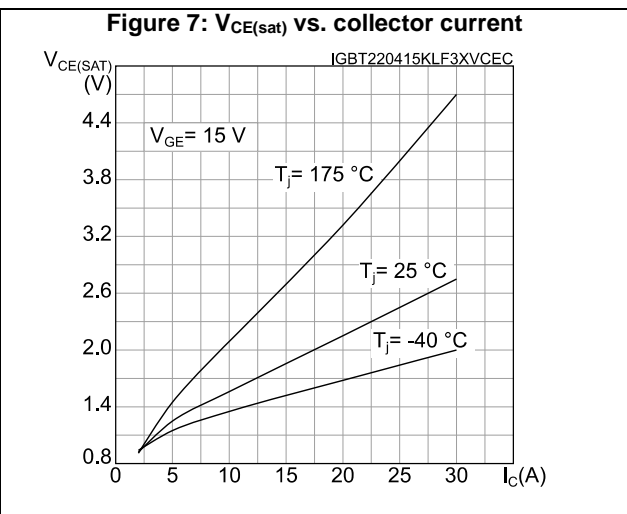
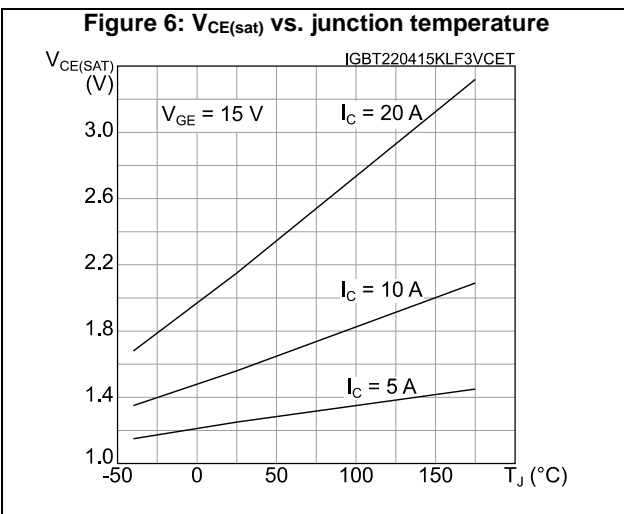
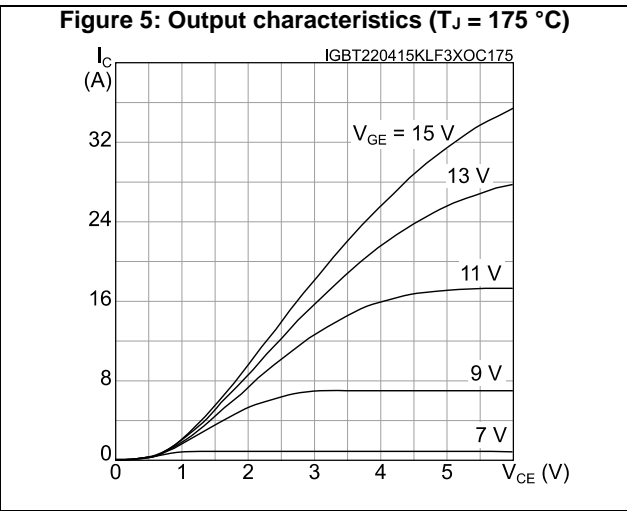
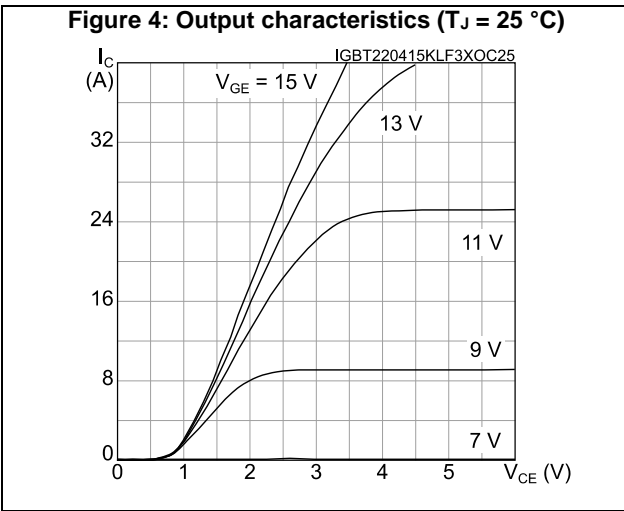
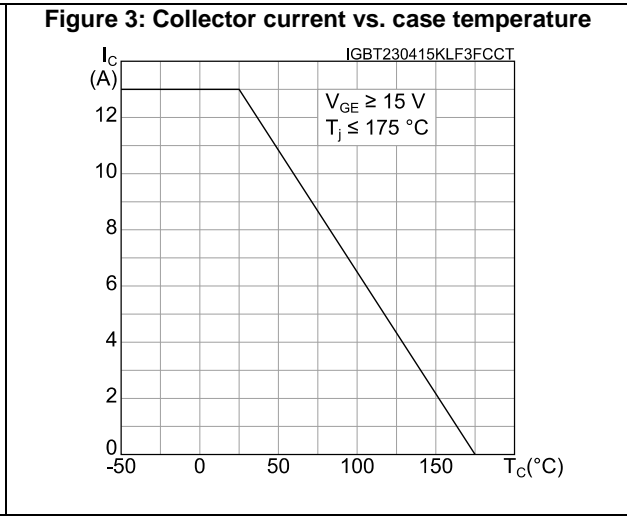
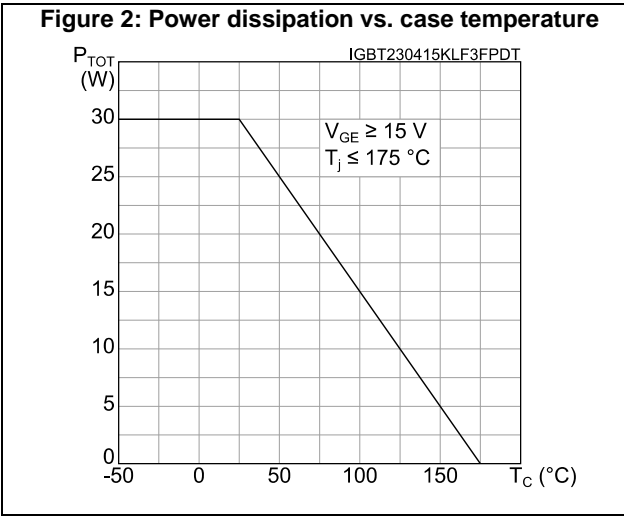

Figure 8: Collector current vs. switching frequency

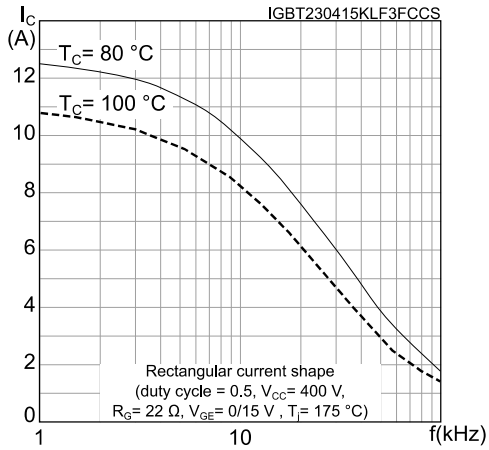

Figure 9: Forward bias safe operating area

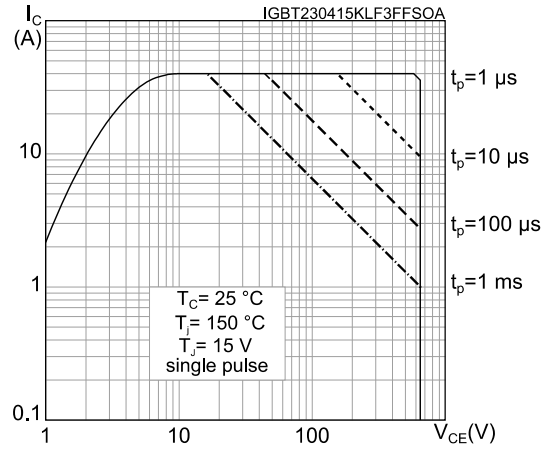

Figure 10: Transfer characteristics

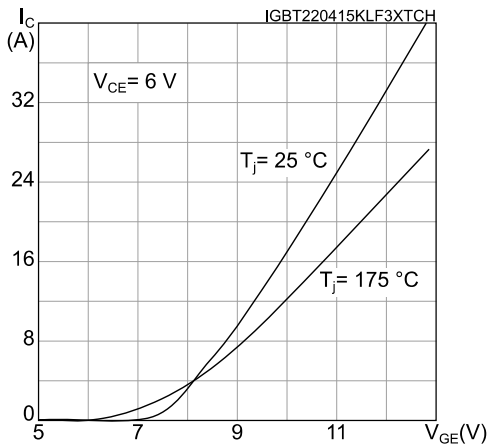

Figure 11: Diode V\_F vs. forward current

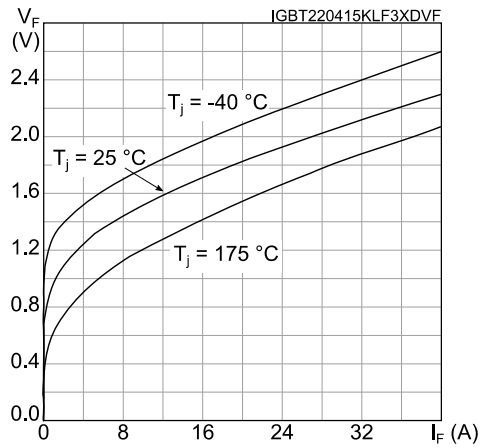

Figure 12: Normalized V\_GE(th) vs. junction temperature

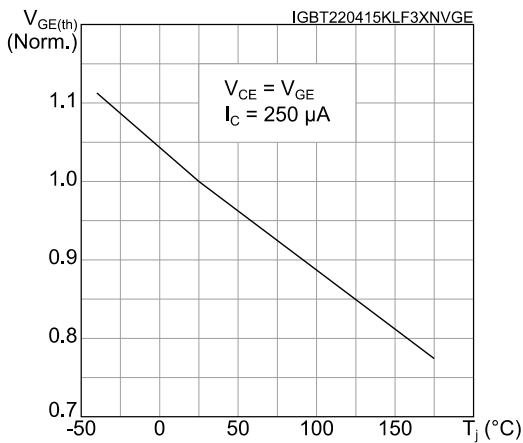
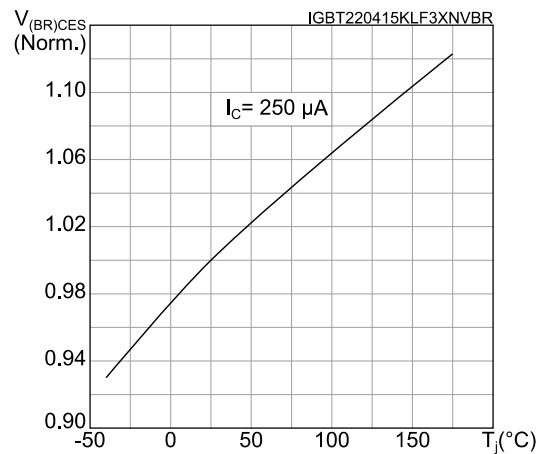
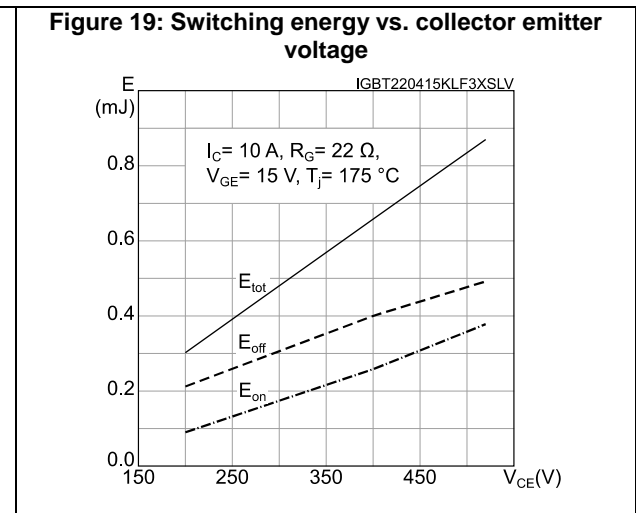
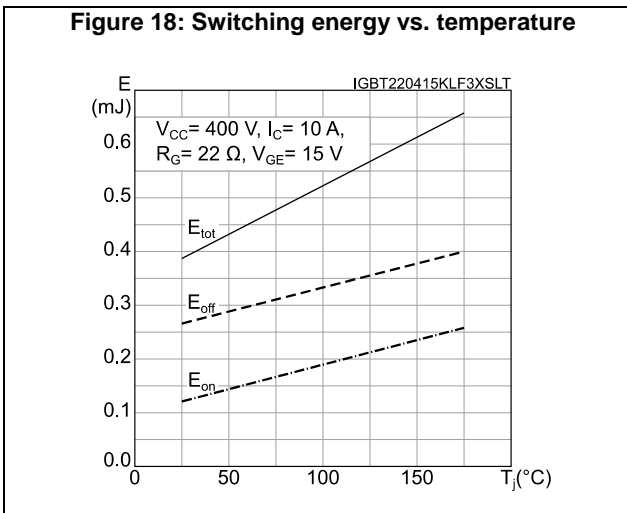
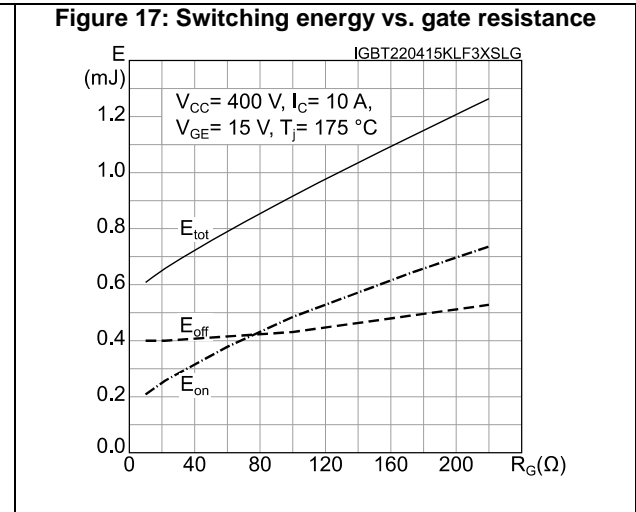
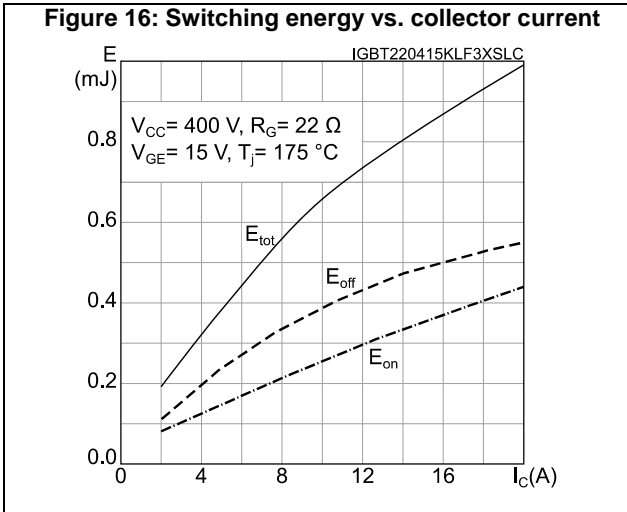
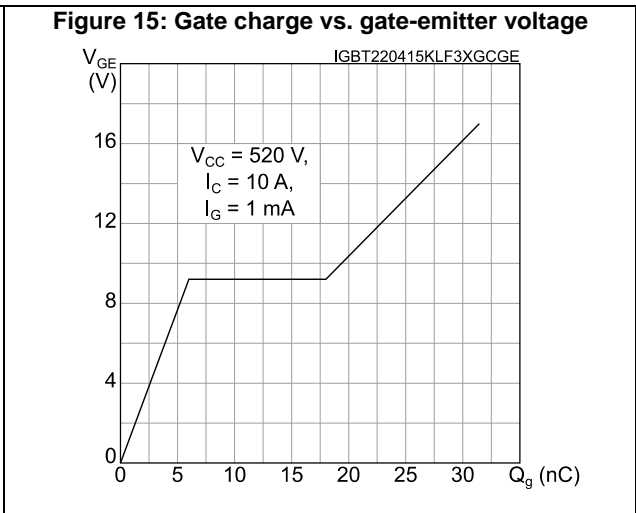
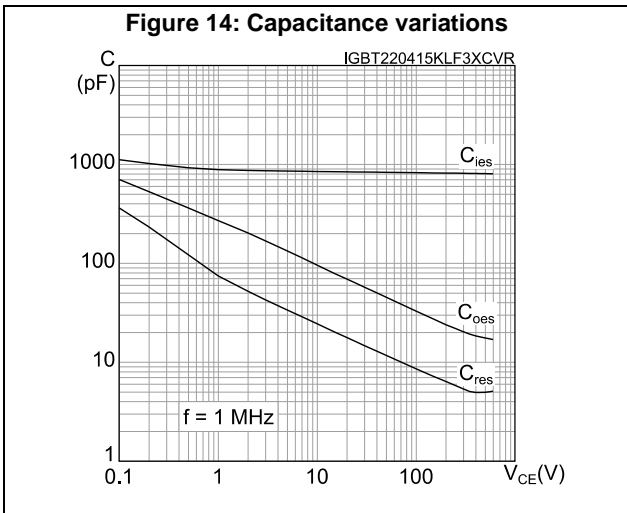

Figure 13: Normalized V\_(BR)CES vs. junction temperature







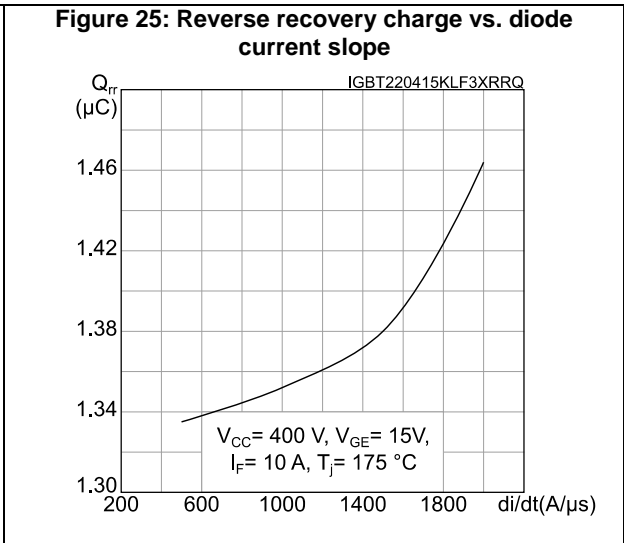
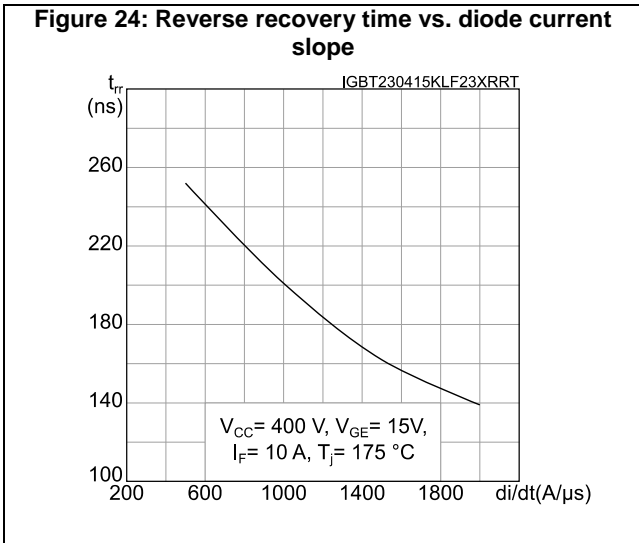
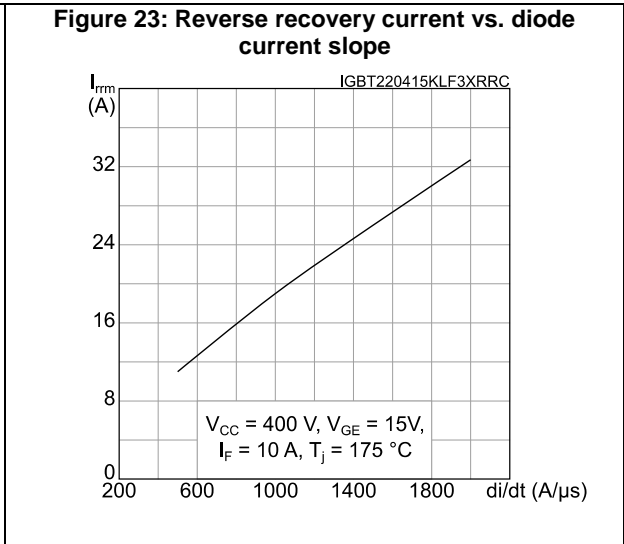
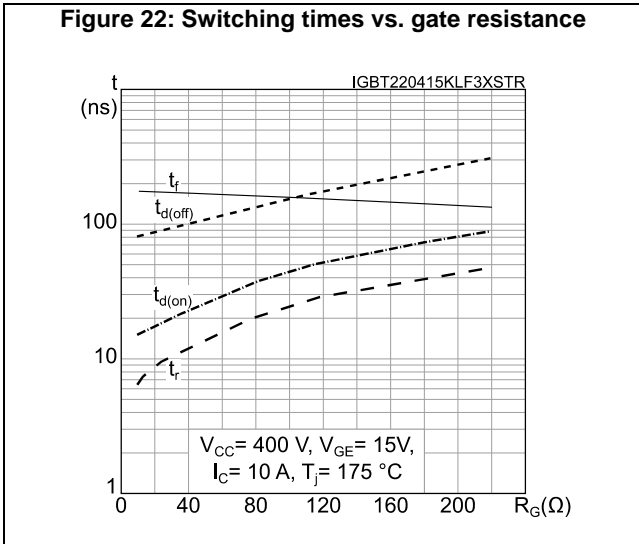
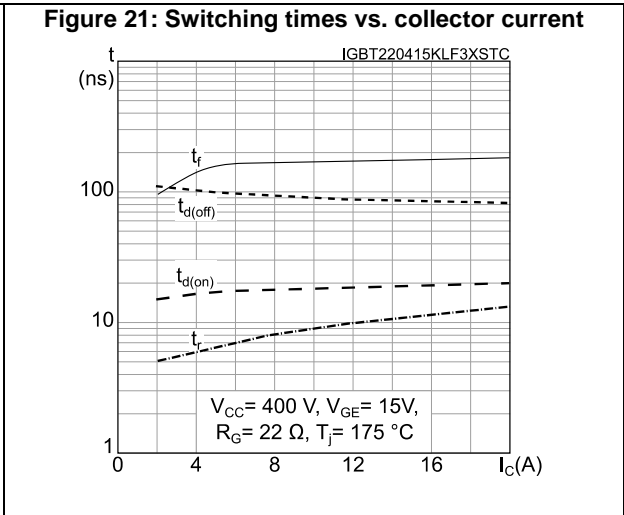
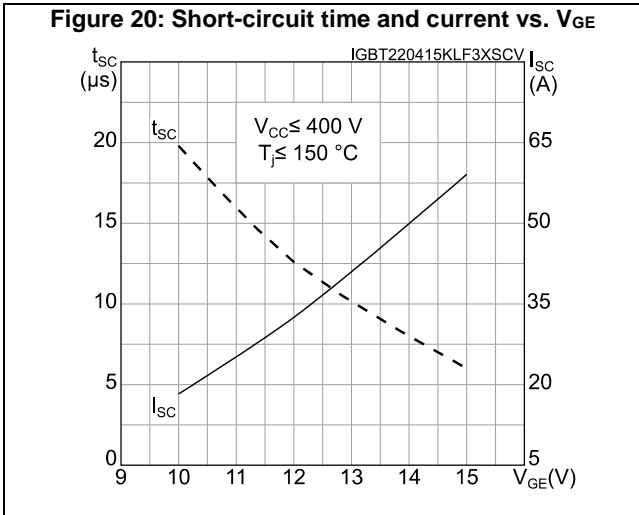

Figure 26: Reverse recovery energy vs. diode current slope

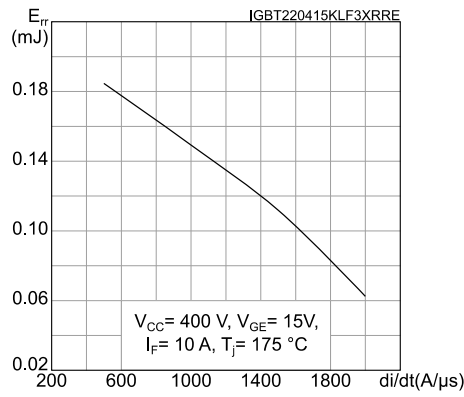

Figure 27: Thermal impedance for IGBT

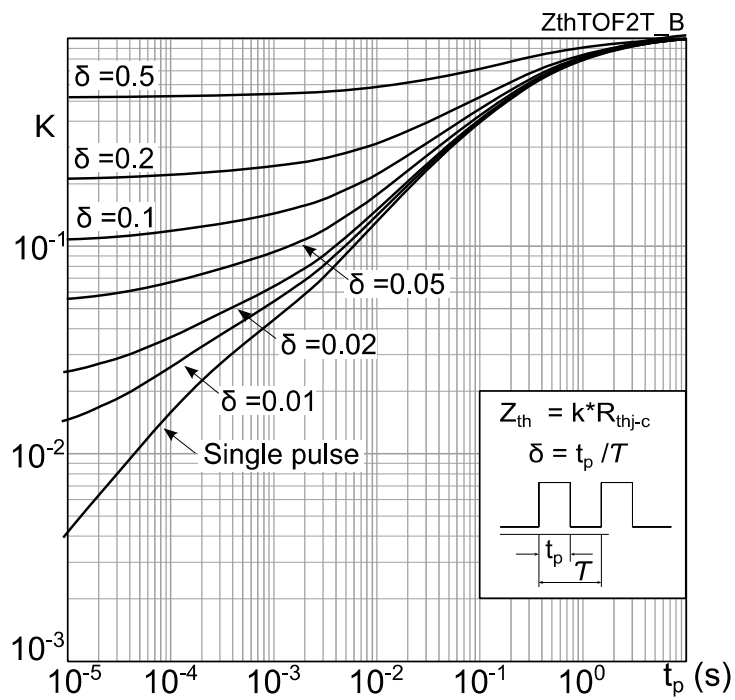
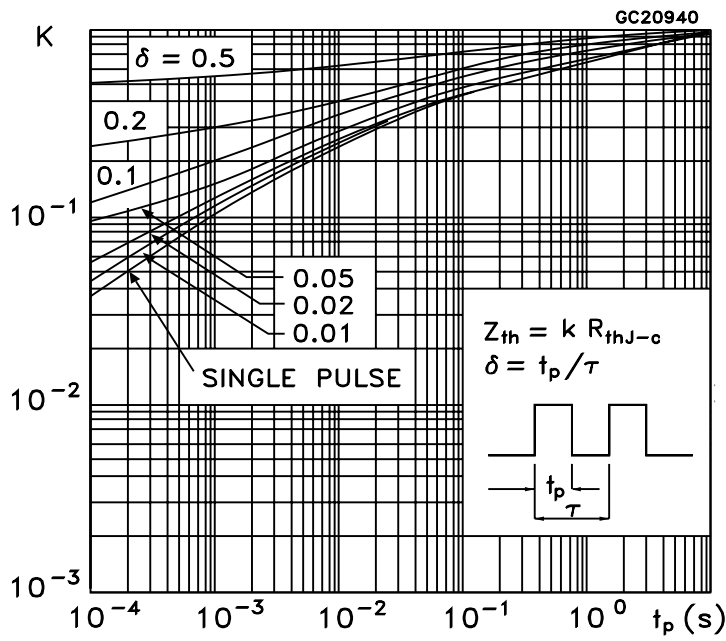
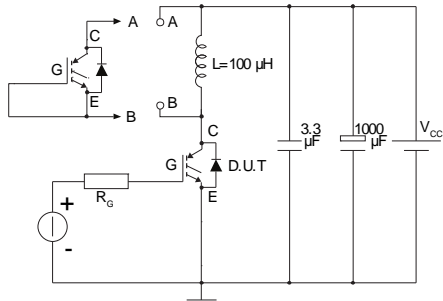

Figure 28: Thermal impedance for diode



### 3 Test circuits

**Figure 29: Test circuit for inductive load switching**



AM01504v1

**Figure 30: Gate charge test circuit**

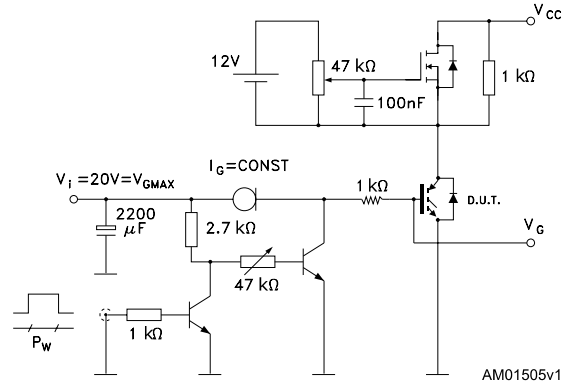

AM01505v1

**Figure 31: Switching waveform**

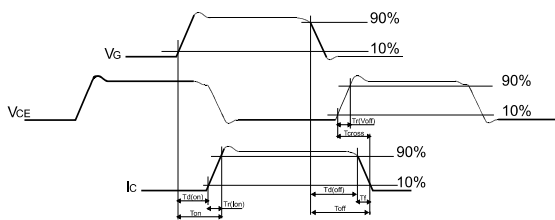

AM01506v1

**Figure 32: Diode reverse recovery waveform**

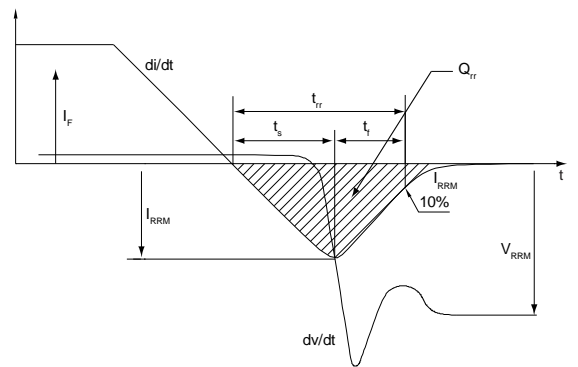

AM01507v1

## 4 Package information

In order to meet environmental requirements, ST offers these devices in different grades of ECOPACK® packages, depending on their level of environmental compliance. ECOPACK® specifications, grade definitions and product status are available at: [www.st.com](http://www.st.com). ECOPACK® is an ST trademark.

### 4.1 TO-220FP package information

Figure 33: TO-220FP package outline

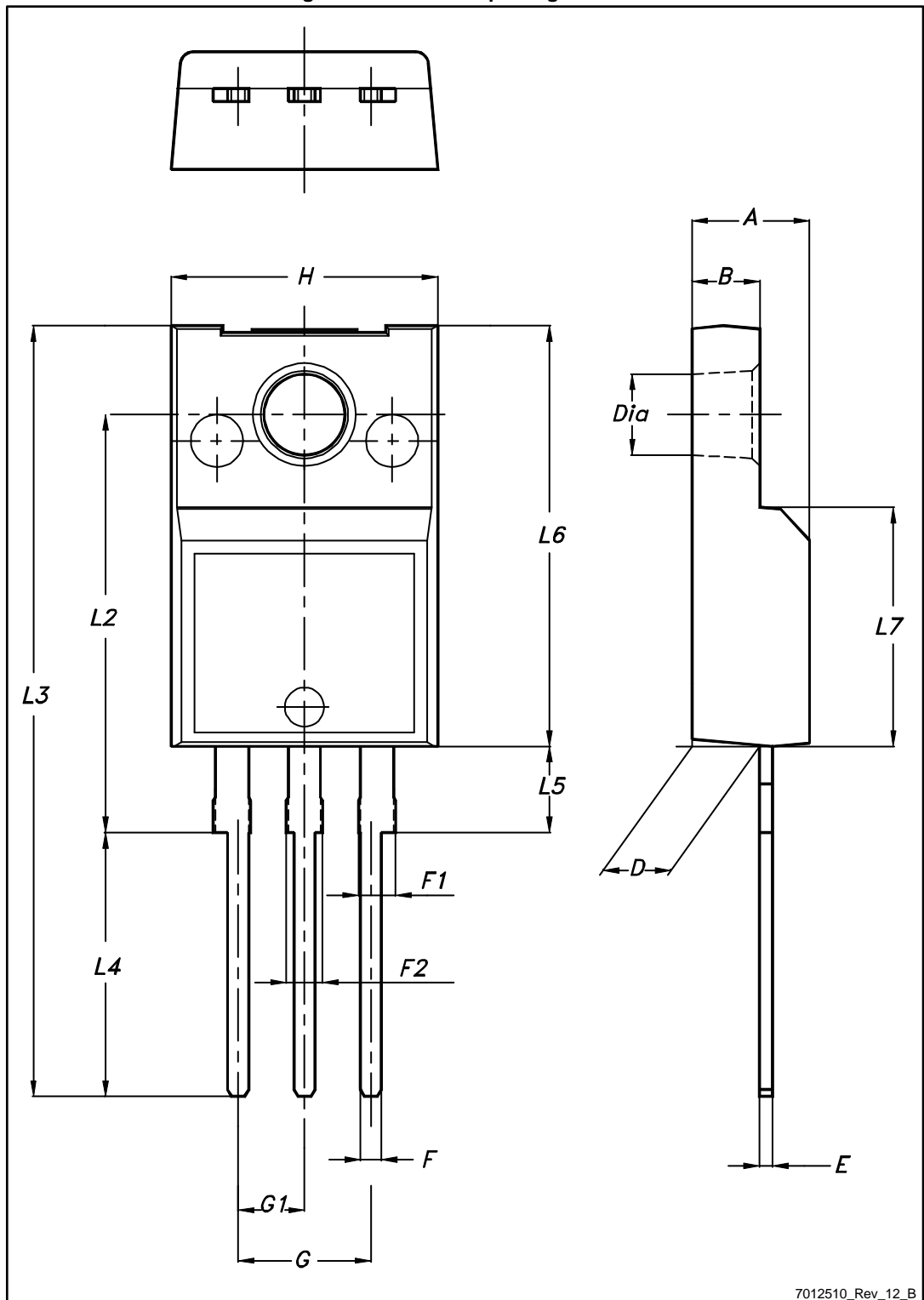

7012510\_Rev\_12\_B

Table 8: TO-220FP package mechanical data

Dim.	mm		
	Min.	Typ.	Max.
A	4.4		4.6
B	2.5		2.7
D	2.5		2.75
E	0.45		0.7
F	0.75		1
F1	1.15		1.70
F2	1.15		1.70
G	4.95		5.2
G1	2.4		2.7
H	10		10.4
L2		16	
L3	28.6		30.6
L4	9.8		10.6
L5	2.9		3.6
L6	15.9		16.4
L7	9		9.3
Dia	3		3.2

## 5 Revision history

**Table 9: Document revision history**

Date	Revision	Changes
10-Feb-2015	1	First release.
23-Apr-2015	2	Minor text edits throughout document In Section 2 Electrical characteristics: - updated Table 4: Static characteristics - updated Table 5: Dynamic characteristics - updated Table 6: IGBT switching characteristics (inductive load) - updated Table 7: Diode switching characteristics (inductive load) Added Section 2.1 Electrical characteristics (curves)
31-Jul-2015	3	Updated table titled "Diode switching characteristics (inductive load)"
19-Oct-2015	4	Updated Table 5: "Dynamic characteristics" and Table 6: "IGBT switching characteristics (inductive load)". Changed Figure 27: "Thermal impedance for IGBT".
21-Oct-2015	5	Updated Table 4: "Static characteristics"
08-Feb-2016	6	Datasheet promoted from preliminary data to production data Minor text changes
07-Apr-2017	7	Modified title, features and applications on cover page. Modified <a href="#">Table 4: "Static characteristics"</a> , <a href="#">Table 6: "IGBT switching characteristics (inductive load)"</a> and <a href="#">Table 7: "Diode switching characteristics (inductive load)"</a> Minor text changes.