

Trench gate field-stop, 650 V, 20 A, high-speed HB2 series IGBT in a TO-220FP package

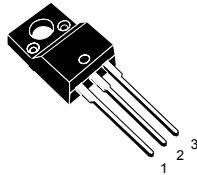

TO-220FP

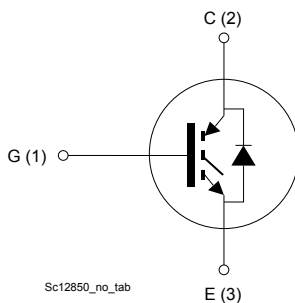

Features

- Maximum junction temperature : $T_J = 175\text{ °C}$
- Low $V_{CE(sat)} = 1.65\text{ V (typ.) @ } I_C = 20\text{ A}$
- Very fast and soft recovery co-packaged diode
- Minimized tail current
- Tight parameter distribution
- Low thermal resistance
- Positive $V_{CE(sat)}$ temperature coefficient

Applications

- Welding
- Power factor correction
- UPS
- Solar inverters
- Chargers

Description

The newest IGBT 650 V HB2 series represents an evolution of the advanced proprietary trench gate field-stop structure. The performance of the HB2 series is optimized in terms of conduction, thanks to a better $V_{CE(sat)}$ behavior at low current values, as well as in terms of reduced switching energy. A very fast soft recovery diode is co-packaged in antiparallel with the IGBT. The result is a product specifically designed to maximize efficiency for a wide range of fast applications.



Product status link

[STGF20H65DFB2](#)

Product summary

Order code	STGF20H65DFB2
Marking	G20H65DFB2
Package	TO-220FP
Packing	Tube

1 Electrical ratings

Table 1. Absolute maximum ratings

Symbol	Parameter	Value	Unit
V_{CES}	Collector-emitter voltage ($V_{GE} = 0$ V)	650	V
$I_C^{(1)}$	Continuous collector current at $T_C = 25$ °C	40	A
	Continuous collector current at $T_C = 100$ °C	25	A
$I_{CP}^{(2)(3)}$	Pulsed collector current	60	A
V_{GE}	Gate-emitter voltage	±20	V
	Transient gate-emitter voltage ($t_p \leq 10$ μs)	±30	
$I_F^{(1)}$	Continuous forward current at $T_C = 25$ °C	40	A
	Continuous forward current at $T_C = 100$ °C	23	
$I_{FP}^{(2)(3)}$	Pulsed forward current	60	A
V_{ISO}	Insulation withstand voltage (RMS) from all three leads to external heat sink ($t = 1$ s, $T_C = 25$ °C)	2.5	kV
P_{TOT}	Total power dissipation at $T_C = 25$ °C	45	W
T_{STG}	Storage temperature range	-55 to 150	°C
T_J	Operating junction temperature range	-55 to 175	°C

1. Limited by maximum junction temperature.
2. Pulse width is limited by maximum junction temperature.
3. Defined by design, not subject to production test.

Table 2. Thermal data

Symbol	Parameter	Value	Unit
R_{thJC}	Thermal resistance junction-case IGBT	3.3	°C/W
	Thermal resistance junction-case diode	5.8	
R_{thJA}	Thermal resistance junction-ambient	62.5	

2 Electrical characteristics

$T_C = 25\text{ °C}$ unless otherwise specified

Table 3. Static characteristics

Symbol	Parameter	Test conditions	Min.	Typ.	Max.	Unit
$V_{(BR)CES}$	Collector-emitter breakdown voltage	$V_{GE} = 0\text{ V}, I_C = 1\text{ mA}$	650			V
$V_{CE(sat)}$	Collector-emitter saturation voltage	$V_{GE} = 15\text{ V}, I_C = 20\text{ A}$		1.65	2.1	V
		$V_{GE} = 15\text{ V}, I_C = 20\text{ A}, T_J = 125\text{ °C}$		1.95		
		$V_{GE} = 15\text{ V}, I_C = 20\text{ A}, T_J = 175\text{ °C}$		2.1		
V_F	Forward on-voltage	$I_F = 20\text{ A}$		1.65	2.55	V
		$I_F = 20\text{ A}, T_J = 125\text{ °C}$		1.4		
		$I_F = 20\text{ A}, T_J = 175\text{ °C}$		1.3		
$V_{GE(th)}$	Gate threshold voltage	$V_{CE} = V_{GE}, I_C = 1\text{ mA}$	5	6	7	V
I_{CES}	Collector cut-off current	$V_{GE} = 0\text{ V}, V_{CE} = 650\text{ V}$			25	μA
I_{GES}	Gate-emitter leakage current	$V_{CE} = 0\text{ V}, V_{GE} = \pm 20\text{ V}$			± 250	nA

Table 4. Dynamic characteristics

Symbol	Parameter	Test conditions	Min.	Typ.	Max.	Unit
C_{ies}	Input capacitance	$V_{CE} = 25\text{ V}, f = 1\text{ MHz}, V_{GE} = 0\text{ V}$	-	1010	-	pF
C_{oes}	Output capacitance		-	81	-	
C_{res}	Reverse transfer capacitance		-	26	-	
Q_g	Total gate charge	$V_{CC} = 520\text{ V}, I_C = 20\text{ A}, V_{GE} = 0\text{ to }15\text{ V}$ (see Figure 28. Gate charge test circuit)	-	56	-	nC
Q_{ge}	Gate-emitter charge		-	9.4	-	
Q_{gc}	Gate-collector charge		-	27.8	-	

Table 5. Switching characteristics (inductive load)

Symbol	Parameter	Test conditions	Min.	Typ.	Max.	Unit
$t_{d(on)}$	Turn-on delay time	$V_{CC} = 400\text{ V}$, $I_C = 20\text{ A}$, $V_{GE} = 15\text{ V}$, $R_G = 10\ \Omega$ (see Figure 27. Test circuit for inductive load switching)	-	16	-	ns
t_r	Current rise time		-	8	-	ns
$E_{on(1)}$	Turn-on switching energy		-	265	-	μJ
$t_{d(off)}$	Turn-off delay time		-	78.8	-	ns
t_f	Current fall time		-	35	-	ns
$E_{off(2)}$	Turn-off switching energy		-	214	-	μJ
$t_{d(on)}$	Turn-on delay time	$V_{CC} = 400\text{ V}$, $I_C = 20\text{ A}$, $V_{GE} = 15\text{ V}$, $R_G = 10\ \Omega$, $T_J = 175\text{ }^\circ\text{C}$ (see Figure 27. Test circuit for inductive load switching)	-	17	-	ns
t_r	Current rise time		-	9	-	ns
$E_{on(1)}$	Turn-on switching energy		-	556	-	μJ
$t_{d(off)}$	Turn-off delay time		-	98	-	ns
t_f	Current fall time		-	80	-	ns
$E_{off(2)}$	Turn-off switching energy		-	378	-	μJ

1. Including the reverse recovery of the diode.
2. Including the tail of the collector current.

Table 6. Diode switching characteristics (inductive load)

Symbol	Parameter	Test conditions	Min.	Typ.	Max.	Unit
t_{rr}	Reverse recovery time	$I_F = 20\text{ A}$, $V_R = 400\text{ V}$, $V_{GE} = 15\text{ V}$, $di/dt = 1000\text{ A}/\mu\text{s}$ (see Figure 30. Diode reverse recovery waveform)	-	215	-	ns
Q_{rr}	Reverse recovery charge		-	970	-	nC
I_{rrm}	Reverse recovery current		-	17	-	A
di_{rr}/dt	Peak rate of fall of reverse recovery current during t_b		-	303	-	$\text{A}/\mu\text{s}$
E_{rr}	Reverse recovery energy		-	293	-	μJ
t_{rr}	Reverse recovery time	$I_F = 20\text{ A}$, $V_R = 400\text{ V}$, $V_{GE} = 15\text{ V}$, $di/dt = 1000\text{ A}/\mu\text{s}$, $T_J = 175\text{ }^\circ\text{C}$ (see Figure 30. Diode reverse recovery waveform)	-	330	-	ns
Q_{rr}	Reverse recovery charge		-	2772	-	nC
I_{rrm}	Reverse recovery current		-	30	-	A
di_{rr}/dt	Peak rate of fall of reverse recovery current during t_b		-	244	-	$\text{A}/\mu\text{s}$
E_{rr}	Reverse recovery energy		-	866	-	μJ

2.1 Electrical characteristics (curves)

Figure 1. Power dissipation vs case temperature

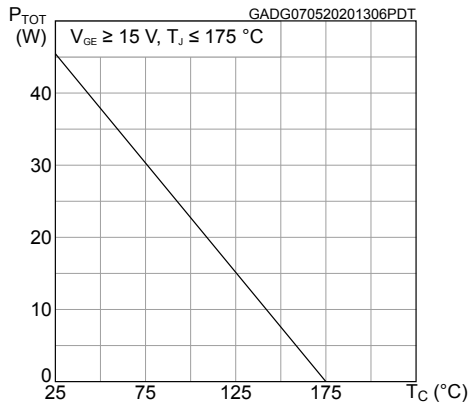

Figure 2. Collector current vs case temperature

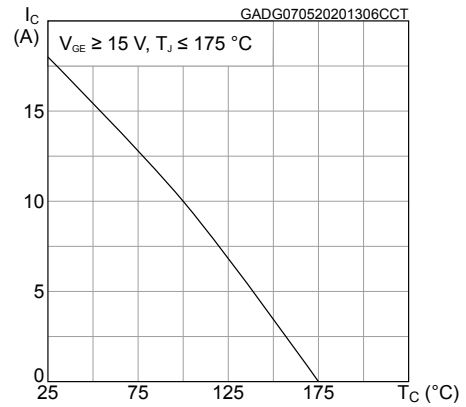

Figure 3. Output characteristics (T_J = 25 °C)

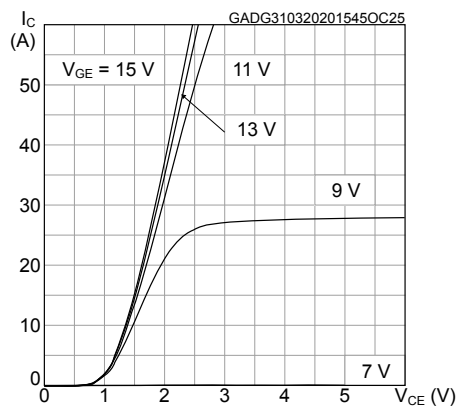

Figure 4. Output characteristics (T_J = 175 °C)

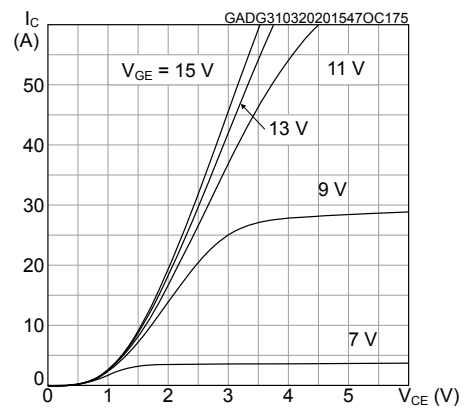

Figure 5. V_{CE(sat)} vs junction temperature

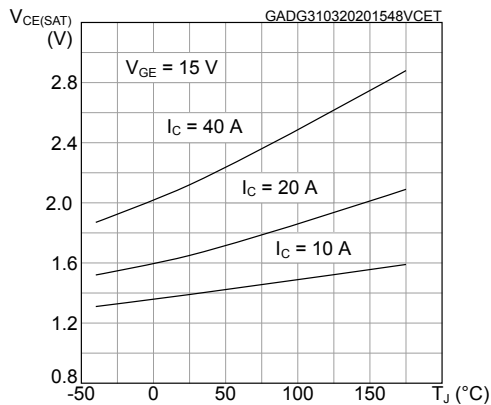

Figure 6. V_{CE(sat)} vs collector current

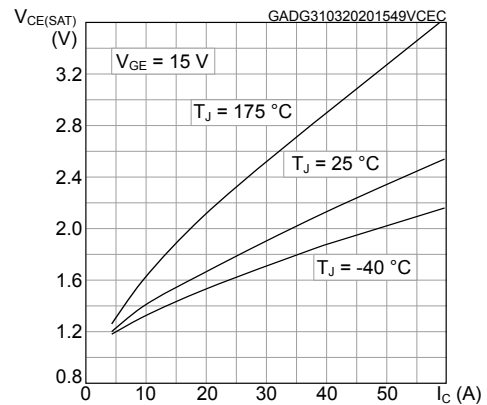

Figure 7. Forward bias safe operating area

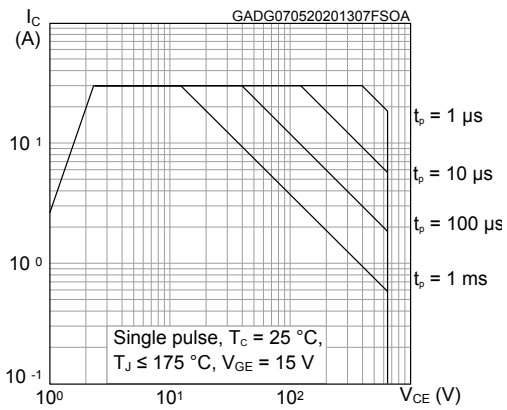

Figure 8. Collector current vs switching frequency

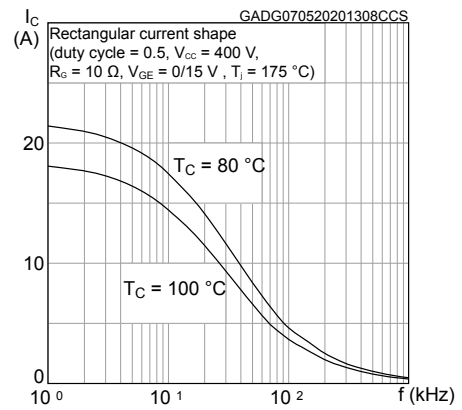

Figure 9. Transfer characteristics

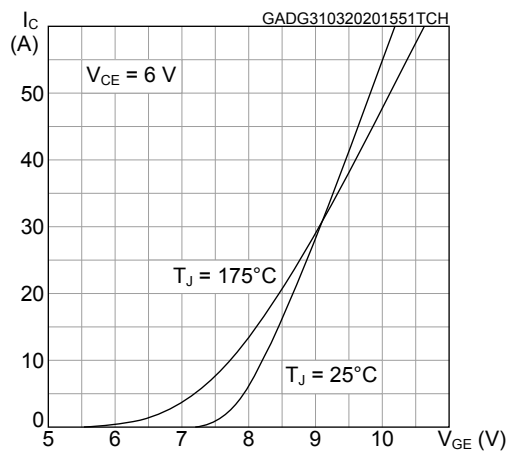

Figure 10. Diode V_F vs forward current

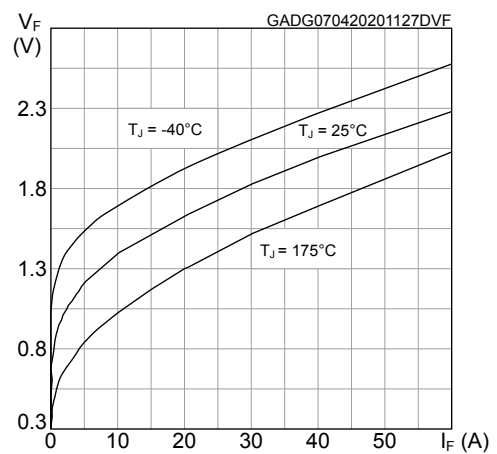

Figure 11. Normalized V_GE(th) vs junction temperature

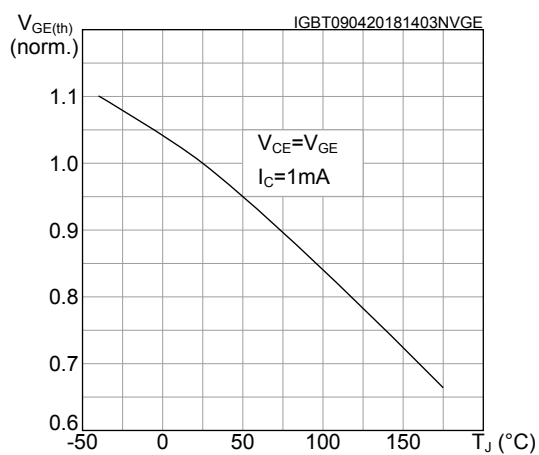

Figure 12. Normalized V_(BR)CES vs junction temperature

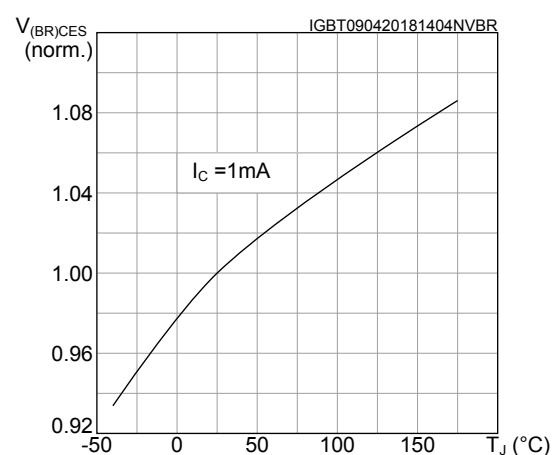

Figure 13. Capacitance variations

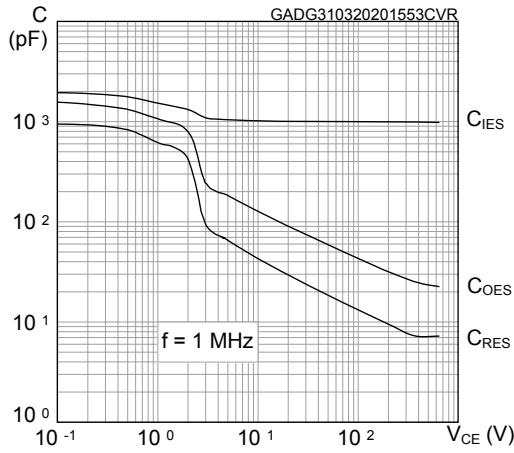

Figure 14. Gate charge vs gate-emitter voltage

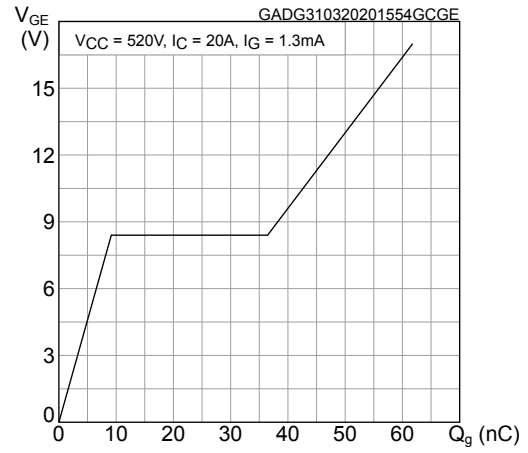

Figure 15. Switching energy vs collector current

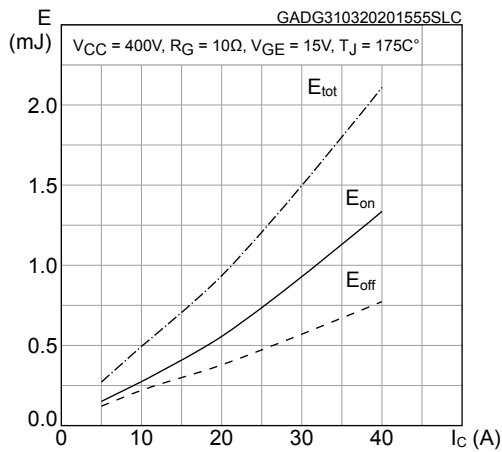

Figure 16. Switching energy vs temperature

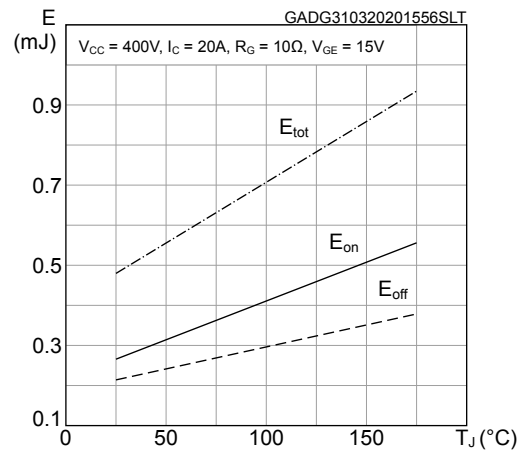

Figure 17. Switching energy vs collector emitter voltage

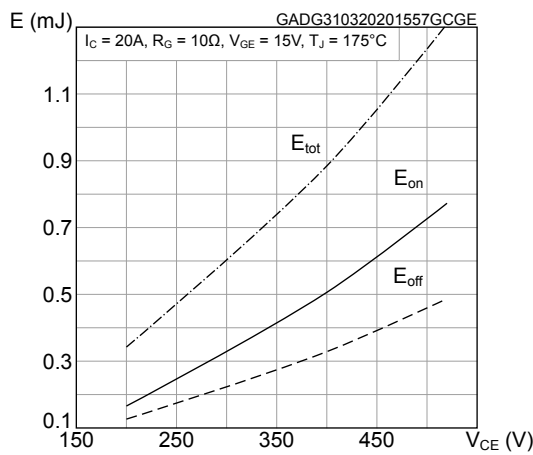

Figure 18. Switching energy vs gate resistance

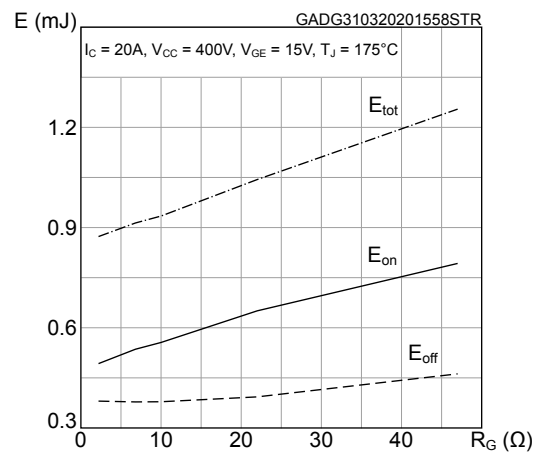

Figure 19. Switching times vs collector current

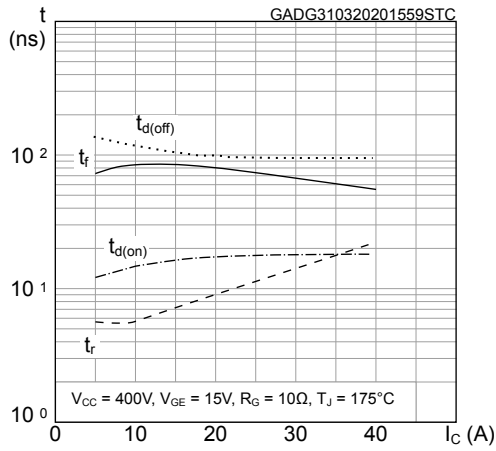

Figure 20. Switching times vs gate resistance

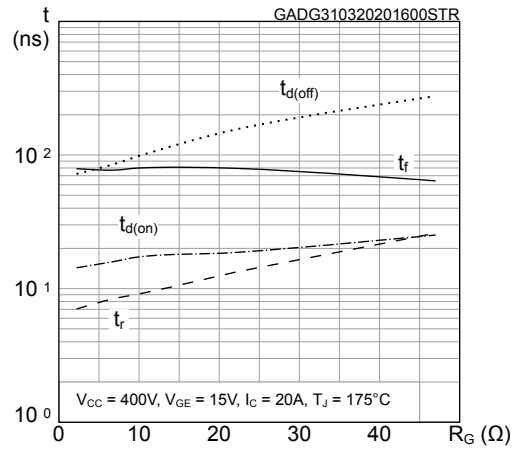

Figure 21. Reverse recovery current vs diode current slope

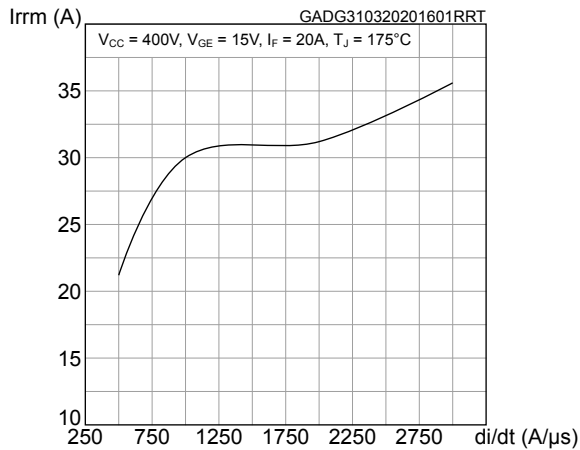

Figure 22. Reverse recovery time vs diode current slope

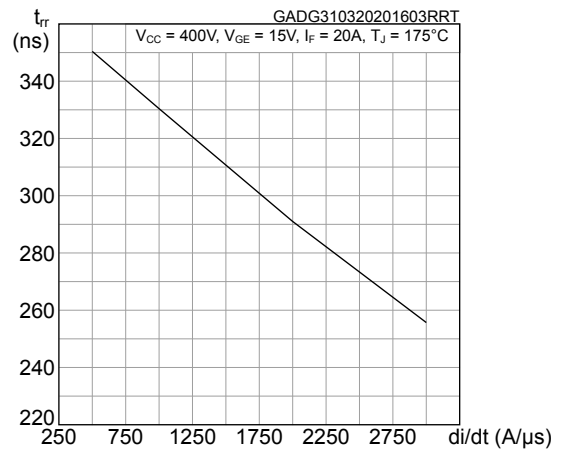

Figure 23. Reverse recovery charge vs diode current slope

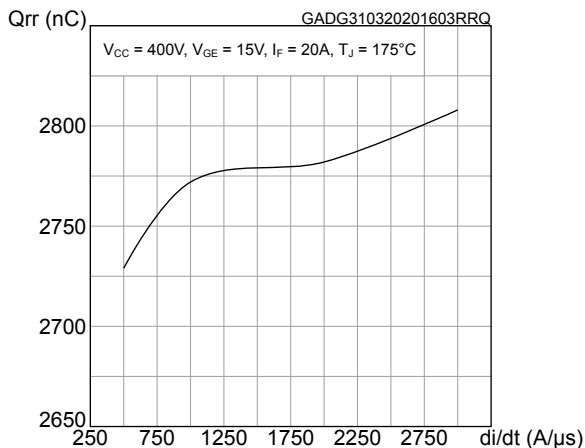

Figure 24. Reverse recovery energy vs diode current slope

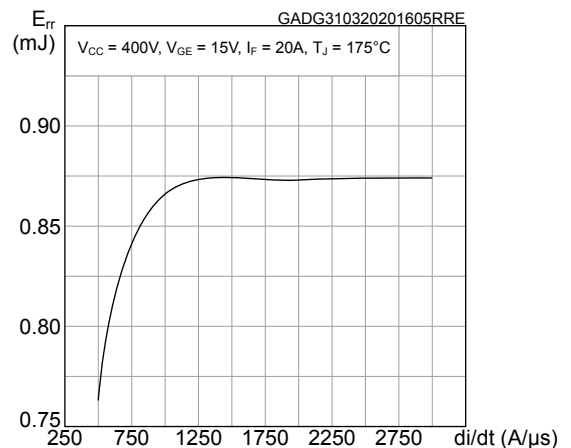

Figure 25. Thermal impedance for IGBT

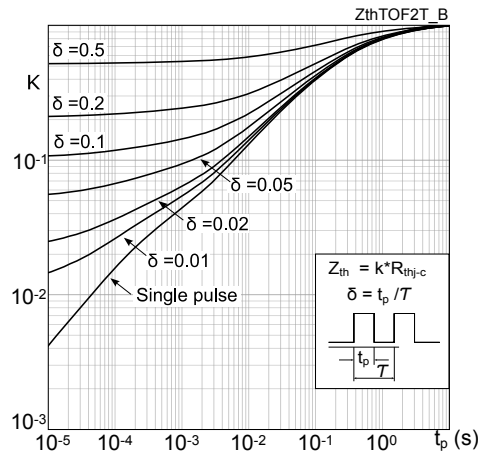
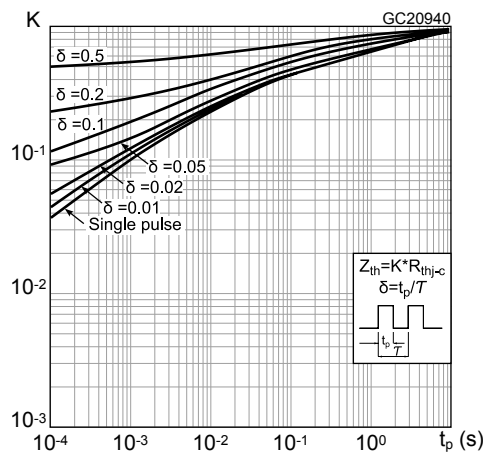

Figure 26. Thermal impedance for diode



3 Test circuits

Figure 27. Test circuit for inductive load switching

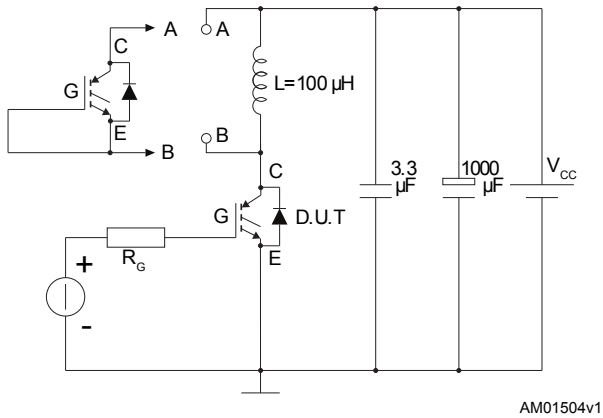

Figure 28. Gate charge test circuit

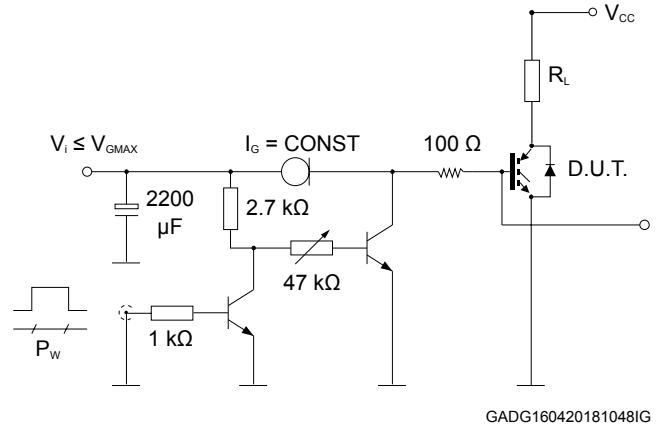

Figure 29. Switching waveform

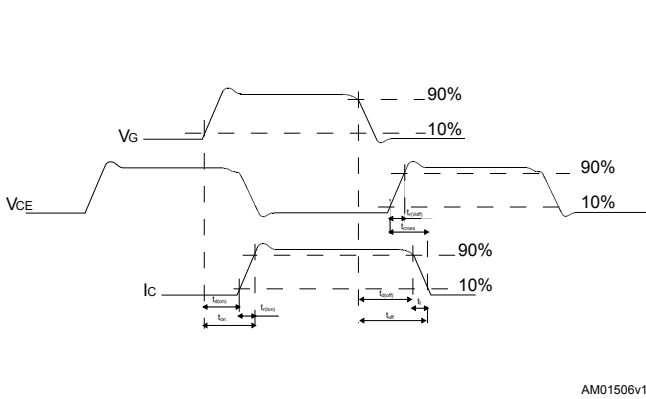
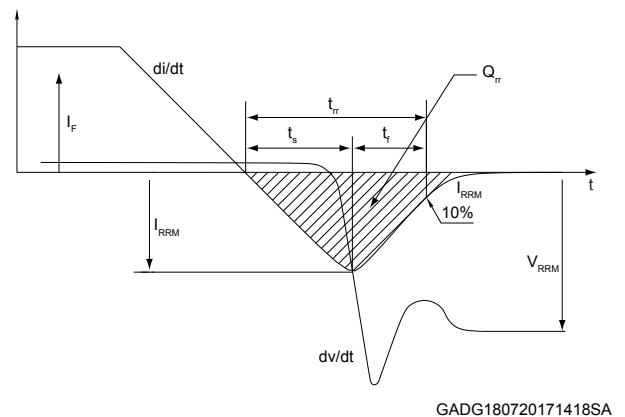

Figure 30. Diode reverse recovery waveform



4 Package information

In order to meet environmental requirements, ST offers these devices in different grades of **ECOPACK** packages, depending on their level of environmental compliance. ECOPACK specifications, grade definitions and product status are available at: www.st.com. ECOPACK is an ST trademark.

4.1 TO-220FP package information

Figure 31. TO-220FP package outline

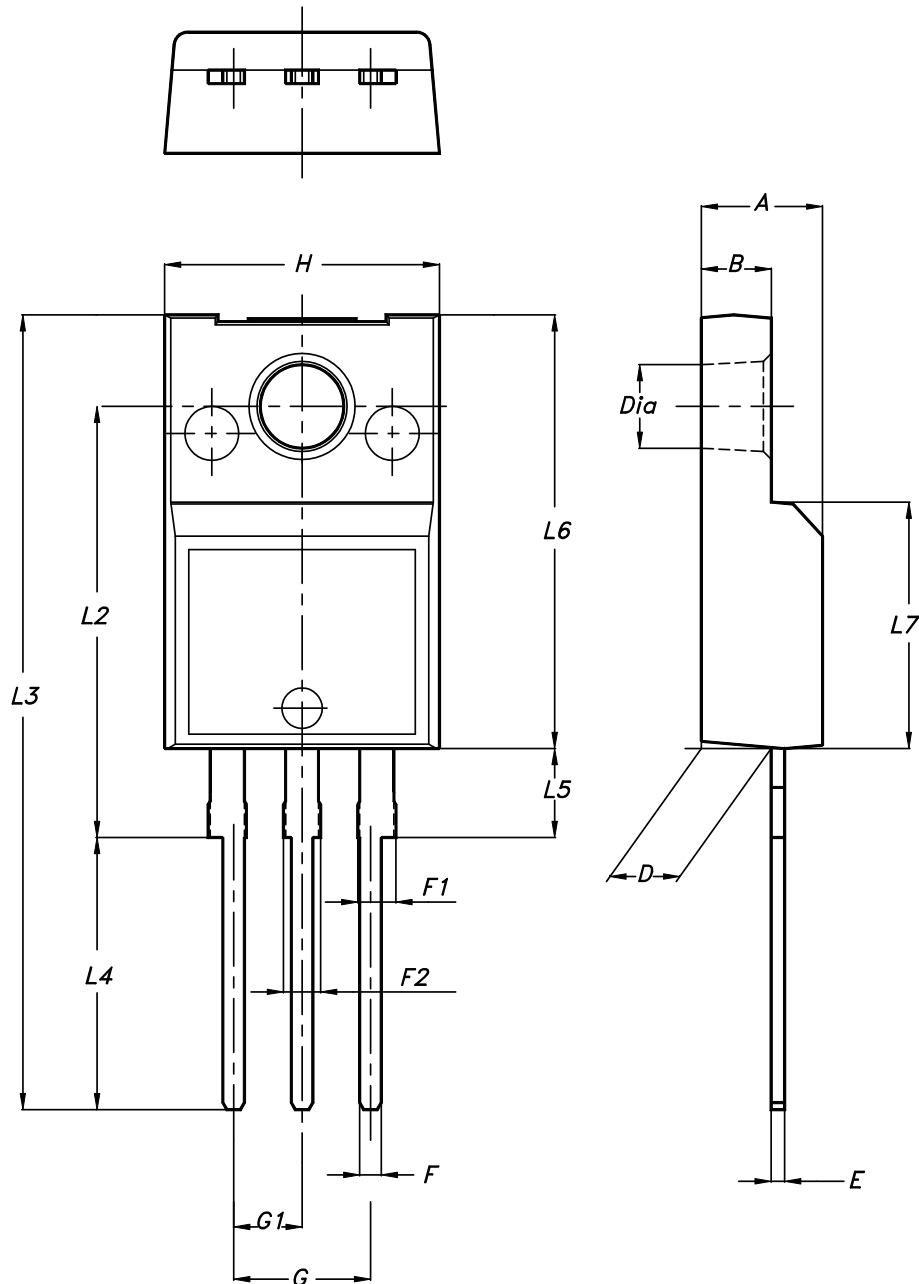

7012510_Rev_13_B

Table 7. TO-220FP package mechanical data

Dim.	mm		
	Min.	Typ.	Max.
A	4.40		4.60
B	2.50		2.70
D	2.50		2.75
E	0.45		0.70
F	0.75		1.00
F1	1.15		1.70
F2	1.15		1.70
G	4.95		5.20
G1	2.40		2.70
H	10.00		10.40
L2		16.00	
L3	28.60		30.60
L4	9.80		10.60
L5	2.90		3.60
L6	15.90		16.40
L7	9.00		9.30
Dia	3.00		3.20

Revision history

Table 8. Document revision history

Date	Version	Changes
18-May-2020	1	First release.

Contents

1	Electrical ratings	2
2	Electrical characteristics	3
2.1	Electrical characteristics (curves)	5
3	Test circuits	10
4	Package information	11
4.1	TO-220FP package information	11
	Revision history	13