

SLLIMM - 2<sup>nd</sup> series IPM, 3-phase inverter, 12 A, 600 V, short-circuit rugged IGBT

SDIP2B-26L type X

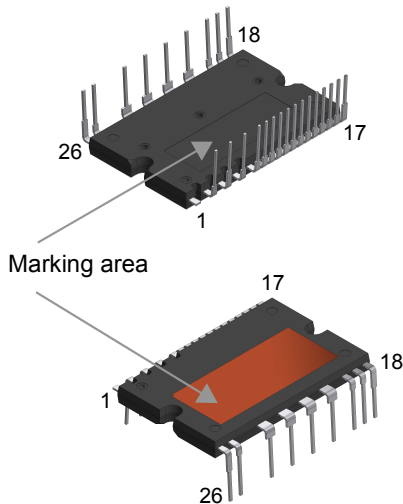

## Product status link

[STGIB8CH60TS-XZ](#)

## Product summary

<b>Order code</b>	STGIB8CH60TS-XZ
<b>Marking</b>	STGIB8CH60TS-XZ
<b>Package</b>	SDIP2B-26L type X
<b>Packing</b>	Tube

## Features

- IPM 12 A, 600 V, 3-phase IGBT inverter bridge including 2 control ICs for gate driving and freewheeling diodes
- 3.3 V, 5 V TTL/CMOS inputs with hysteresis
- Internal bootstrap diode
- Undervoltage lockout of gate drivers
- Smart shutdown function
- Short-circuit protection
- Shutdown input/fault output
- Separate open emitter outputs
- Built-in temperature sensor
- Comparator for fault protection
- Short-circuit rugged TFS IGBT
- Very fast, soft recovery diodes
- 85 kΩ NTC, UL 1434, CA 4 recognized
- Fully isolated package
- Isolation rating of 1600 Vrms/min
- UL recognition: UL 1557, file E81734
- Embedded TVS to enhance ESD protection

## Applications

- 3-phase inverters for motor drives
- Washing machines
- Dryer
- Pumps
- Air conditioners
- Sewing machines

## Description

This second series of SLLIMM (small low-loss intelligent molded module) provides a compact, high-performance AC motor drive in a simple, rugged design. It combines new ST proprietary control ICs (one LS and one HS driver) with an improved short-circuit rugged trench gate field-stop (TFS) IGBT, making it ideal for motor drives operating up to 20 kHz in hard-switching circuitries.

# 1 Internal schematic and pin description

Figure 1. Internal schematic diagram and pin configuration

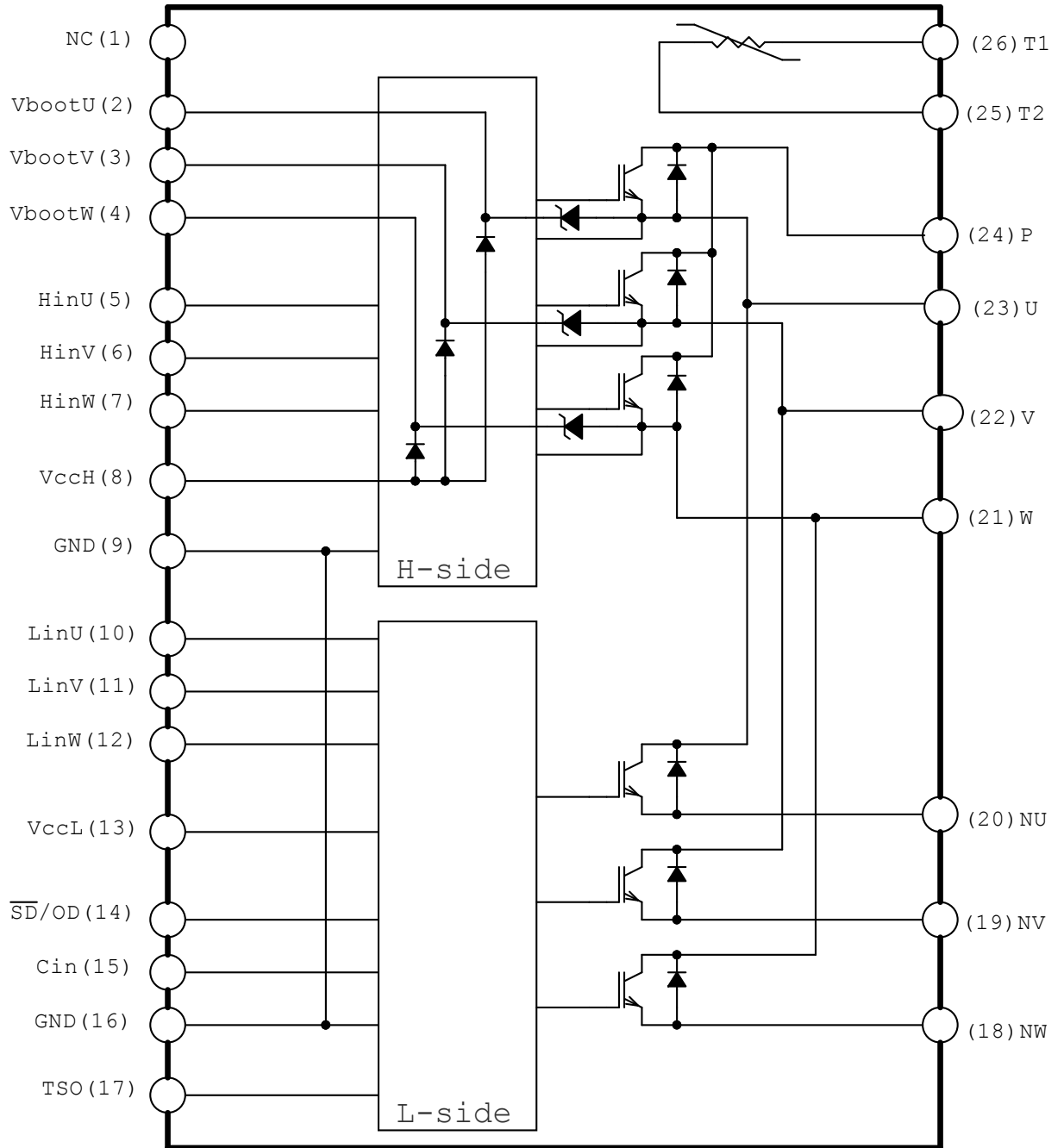

GADG310320201209GT

**Table 1. Pin description**

Pin	Symbol	Description
1	NC	-
2	VBOOTu	Bootstrap voltage for U phase
3	VBOOTv	Bootstrap voltage for V phase
4	VBOOTw	Bootstrap voltage for W phase
5	HINu	High-side logic input for U phase
6	HINv	High-side logic input for V phase
7	HINw	High-side logic input for W phase
8	VCCH	High-side low voltage power supply
9	GND	Ground
10	LINu	Low-side logic input for U phase
11	LINv	Low-side logic input for V phase
12	LINw	Low-side logic input for W phase
13	VCCL	Low-side low voltage power supply
14	$\overline{SD}$ / OD	Shutdown logic input (active low) / open-drain (comparator output)
15	CIN	Comparator input
16	GND	Ground
17	TSO	Temperature sensor output
18	NW	Negative DC input for W phase
19	NV	Negative DC input for V phase
20	NU	Negative DC input for U phase
21	W	W phase output
22	V	V phase output
23	U	U phase output
24	P	Positive DC input
25	T2	NTC thermistor terminal 2
26	T1	NTC thermistor terminal 1

## 2 Absolute maximum ratings

$T_J = 25\text{ °C}$  unless otherwise noted.

**Table 2. Inverter part**

Symbol	Parameter	Value	Unit
$V_{PN}$	Supply voltage among P -N <sub>U</sub> , -N <sub>V</sub> , -N <sub>W</sub>	450	V
$V_{PN(surge)}$	Supply voltage surge among P -N <sub>U</sub> , -N <sub>V</sub> , -N <sub>W</sub>	500	V
$V_{CES}$	Collector-emitter voltage each IGBT	600	V
$\pm I_C$	Continuous collector current each IGBT ( $T_C = 25\text{ °C}$ )	12	A
	Continuous collector current each IGBT ( $T_C = 80\text{ °C}$ )	8	
$\pm I_{CP}$	Peak collector current each IGBT (less than 1 ms)	24	A
$P_{TOT}$	Total power dissipation at $T_C = 25\text{ °C}$ each IGBT	50	W
$t_{scw}$	Short-circuit withstand time, $V_{CE} = 300\text{ V}$ , $T_J = 125\text{ °C}$ , $V_{CC} = V_{boot} = 15\text{ V}$ , $V_{IN} = 0\text{ to }5\text{ V}$	5	$\mu\text{s}$

**Table 3. Control part**

Symbol	Parameter	Min.	Max.	Unit
$V_{CC}$	Supply voltage between $V_{CCH-GND}$ , $V_{CCL-GND}$	-0.3	20	V
$V_{BOOT}$	Bootstrap voltage	-0.3	619	V
$V_{OUT}$	Output voltage among U, V, W and GND	$V_{BOOT} - 21$	$V_{BOOT} + 0.3$	V
$V_{CIN}$	Comparator input voltage	-0.3	20	V
$V_{IN}$	Logic input voltage applied among HINx, LINx and GND	-0.3	15	V
$V_{SD/OD}$	Open-drain voltage	-0.3	7	V
$I_{SD/OD}$	Open-drain sink current		10	mA
$V_{TSO}$	Temperature sensor output voltage	-0.3	5.5	V
$I_{TSO}$	Temperature sensor output current		7	mA

**Table 4. Total system**

Symbol	Parameter	Value	Unit
$V_{ISO}$	Isolation withstand voltage applied between each pin and heat sink plate (AC voltage, $t = 60\text{ s}$ )	1600	Vrms
$T_J$	Power chip operating junction temperature range	-40 to 175	$^{\circ}\text{C}$
$T_C$	Module operation case temperature range	-40 to 125	$^{\circ}\text{C}$

## 2.1 Thermal data

**Table 5. Thermal data**

Symbol	Parameter	Value	Unit
R <sub>thJC</sub>	Thermal resistance, junction-to-case, single IGBT	3	°C/W
	Thermal resistance, junction-to-case, single diode	6	

### 3 Electrical characteristics

$T_J = 25\text{ °C}$  unless otherwise specified.

#### 3.1 Inverter part

**Table 6. Static**

Symbol	Parameter	Test conditions	Min.	Typ.	Max.	Unit
$I_{CES}$	Collector cut-off current	$V_{CE} = 600\text{ V}, V_{CC} = V_{boot} = 15\text{ V}$	-		100	$\mu\text{A}$
$V_{CE(sat)}$	Collector-emitter saturation voltage	$V_{CC} = V_{boot} = 15\text{ V}, V_{IN(1)} = 0\text{ to }5\text{ V}, I_C = 8\text{ A}$	-	1.68	2.18	V
		$V_{CC} = V_{boot} = 15\text{ V}, V_{IN(1)} = 0\text{ to }5\text{ V}, I_C = 12\text{ A}$	-	1.91		
$V_F$	Diode forward voltage	$V_{IN} = 0\text{ V}, I_C = 8\text{ A}$	-	1.55	2.10	V
		$V_{IN} = 0\text{ V}, I_C = 12\text{ A}$	-	1.70		V

1. Applied among  $HINx$ ,  $LINx$  and  $GND$  for  $x = U, V, W$ .

**Table 7. Inductive load switching time and energy**

Symbol	Parameter	Test conditions	Min.	Typ.	Max.	Unit	
$t_{on(1)}$	Turn-on time	$V_{DD} = 300\text{ V}, V_{CC} = V_{boot} = 15\text{ V}, V_{IN(2)} = 0\text{ to }5\text{ V}, I_C = 8\text{ A}$	-	280	-	ns	
$t_{c(on)(1)}$	Crossover time on		-	142	-		
$t_{off(1)}$	Turn-off time		-	400	-		
$t_{c(off)(1)}$	Crossover time off		-	85	-		
$t_{rr}$	Reverse recovery time		-	215	-		
$E_{on}$	Turn-on switching energy	$V_{DD} = 300\text{ V}, V_{CC} = V_{boot} = 15\text{ V}, V_{IN(2)} = 0\text{ to }5\text{ V}, I_C = 12\text{ A}$	-	201	-	$\mu\text{J}$	
$E_{off}$	Turn-off switching energy		-	102	-		
$E_{rr}$	Reverse recovery energy		-	8.1	-		
$t_{on(1)}$	Turn-on time		$V_{DD} = 300\text{ V}, V_{CC} = V_{boot} = 15\text{ V}, V_{IN(2)} = 0\text{ to }5\text{ V}, I_C = 12\text{ A}$	-	300	-	ns
$t_{c(on)(1)}$	Crossover time on			-	175	-	
$t_{off(1)}$	Turn-off time			-	380	-	
$t_{c(off)(1)}$	Crossover time off			-	85	-	
$t_{rr}$	Reverse recovery time	-		220	-		
$E_{on}$	Turn-on switching energy	-		340	-	$\mu\text{J}$	
$E_{off}$	Turn-off switching energy	-		160	-		
$E_{rr}$	Reverse recovery energy	-	10.2	-			

1.  $t_{on}$  and  $t_{off}$  include the propagation delay times of the internal drive.  $t_{c(on)}$  and  $t_{c(off)}$  are the switching times of the IGBT itself under the internally given gate driving conditions.

2. Applied among  $HINx$ ,  $LINx$  and  $GND$  for  $x = U, V, W$ .

Figure 2. Switching time test circuit



Figure 3. Switching time definition



AM09223V1

### 3.2 Control/protection parts

**Table 8. High- and low-side drivers**

Symbol	Parameter	Test condition	Min.	Typ.	Max.	Unit
$V_{il}$	Low logic level voltage				0.8	V
$V_{ih}$	High logic level voltage		2			V
$I_{INh}$	IN logic "1" input bias current	$IN_x = 15\text{ V}$	80	150	200	$\mu\text{A}$
$I_{INl}$	IN logic "0" input bias current	$IN_x = 0\text{ V}$			1	$\mu\text{A}$
<b>High-side</b>						
$V_{CC\_hys}$	$V_{CC}$ UV hysteresis		1.2	1.4	1.7	V
$V_{CCH\_th(on)}$	$V_{CCH}$ UV turn-on threshold		11	11.5	12	V
$V_{CCH\_th(off)}$	$V_{CCH}$ UV turn-off threshold		9.6	10.1	10.6	V
$V_{BS\_hys}$	$V_{BS}$ UV hysteresis		0.5	1	1.6	V
$V_{BS\_th(on)}$	$V_{BS}$ UV turn-on threshold		10.1	11	11.9	V
$V_{BS\_th(off)}$	$V_{BS}$ UV turn-off threshold		9.1	10	10.9	V
$I_{QBSU}$	Under voltage $V_{BS}$ quiescent current	$V_{BS} = 9\text{ V}$ , $HINx^{(1)} = 5\text{ V}$		55	75	$\mu\text{A}$
$I_{QBS}$	$V_{BS}$ quiescent current	$V_{CC} = 15\text{ V}$ , $HINx^{(1)} = 5\text{ V}$		125	170	$\mu\text{A}$
$I_{qccu}$	Under voltage quiescent supply current	$V_{CC} = 9\text{ V}$ , $HINx^{(1)} = 0\text{ V}$		190	250	$\mu\text{A}$
$I_{qcc}$	Quiescent current	$V_{CC} = 15\text{ V}$ , $HINx^{(1)} = 0\text{ V}$		560	730	$\mu\text{A}$
$R_{DS(on)}$	BS driver ON resistance			150		$\Omega$
<b>Low-side</b>						
$V_{CC\_hys}$	$V_{CC}$ UV hysteresis		1.1	1.4	1.6	V
$V_{CCL\_th(on)}$	$V_{CCL}$ UV turn-on threshold		10.4	11.6	12.4	V
$V_{CCL\_th(off)}$	$V_{CCL}$ UV turn-off threshold		9.0	10.3	11	V
$I_{qccu}$	Under voltage quiescent supply current	$V_{CC} = 10\text{ V}$ , $\overline{SD}$ pulled to 5 V through $R_{SD} = 10\text{ k}\Omega$ , $CIN = LINx^{(1)} = 0\text{ V}$		600	800	$\mu\text{A}$
$I_{qcc}$	Quiescent current	$V_{CC} = 15\text{ V}$ , $\overline{SD} = 5\text{ V}$ , $CIN = LINx^{(1)} = 0\text{ V}$		700	900	$\mu\text{A}$
$V_{SSD}$	Smart $\overline{SD}$ unlatch threshold		0.5	0.6	0.75	V
$I_{SDh}$	$\overline{SD}$ logic "1" input bias current	$\overline{SD} = 5\text{ V}$	25	50	70	$\mu\text{A}$
$I_{SDl}$	$\overline{SD}$ logic "0" input bias current	$\overline{SD} = 0\text{ V}$			1	$\mu\text{A}$

1. Applied between  $HINx$ ,  $LINx$  and  $GND$  for  $x = U, V, W$ .



**Table 9. Temperature sensor output**

Symbol	Parameter	Test condition	Min.	Typ.	Max.	Unit
$V_{TSO}$	Temperature sensor output voltage	$T_J = 25\text{ }^\circ\text{C}$	0.974	1.16	1.345	V
$I_{TSO\_SNK}$	Temperature sensor sink current capability			0.1		mA
$I_{TSO\_SRC}$	Temperature sensor source current capability		4			mA

**Table 10. Sense comparator ( $V_{CC} = 15\text{ V}$ , unless otherwise is specified)**

Symbol	Parameter	Test condition	Min.	Typ.	Max.	Unit
$I_{CIN}$	CIN input bias current	$V_{CIN} = 1\text{ V}$	-0.2		0.2	$\mu\text{A}$
$V_{ref}$	Internal reference voltage		460	510	560	mV
$V_{OD}$	Open-drain low level output voltage	$I_{od} = 5\text{ mA}$			500	mV
$t_{CIN\_SD}$	$C_{IN}$ comparator delay to $\overline{SD}$	$\overline{SD}$ pulled to 5 V through $R_{SD} = 10\text{ k}\Omega$ ; measured applying a voltage step 0-1 V to pin CIN; 50% CIN to 90% $\overline{SD}$	240	320	410	ns
$SR_{SD}$	$\overline{SD}$ fall slew rate	$\overline{SD}$ pulled to 5 V through $R_{SD} = 10\text{ k}\Omega$ ; $C_L = 1\text{ nF}$ through $\overline{SD}$ and ground; 90% $\overline{SD}$ to 10% $\overline{SD}$		25		V/ $\mu\text{s}$

The comparator stays enabled even if  $V_{CC}$  is in the UVLO condition but higher than 4 V.

## 4 Fault management

The device integrates an open-drain output connected to the  $\overline{SD}$  pin. As soon as a fault occurs, the open-drain is activated and the LVGx outputs are forced low. Two types of fault can be identified:

- Overcurrent (OC) sensed by the internal comparator (see more detail in [Section 4.1 Smart shutdown function](#));
- Undervoltage on supply voltage ( $V_{CC}$ )

Each fault enables the SD open drain for a different time, as described in the following table.

**Table 11. Fault timing**

Symbol	Parameter	Event time <sup>(1)</sup>	SD open-drain enable time result <sup>(1)(2)</sup>
OC	Over-current event	$\leq 24 \mu\text{s}$	24 $\mu\text{s}$
		$> 24 \mu\text{s}$	OC time
UVLO	Under-voltage lockout event	$\leq 70 \mu\text{s}$	70 $\mu\text{s}$
		$> 70 \mu\text{s}$ until the $V_{CC\_LS}$ exceeds the $V_{CC\_LS}$ UV turn ON threshold	UVLO time

1. Typical value ( $-40 \text{ }^\circ\text{C} \leq T_J \leq +125 \text{ }^\circ\text{C}$ ).

2. Without contribution of the RC network on SD.

Actually, the device remains in a fault condition ( $\overline{SD}$  at low logic level and LVGx outputs disabled) for a time also depending on the RC network connected to the SD pin. The network generates a time contribution that is added to the internal value.

**Figure 4. Overcurrent timing (without contribution of the RC network on  $\overline{SD}$ )**

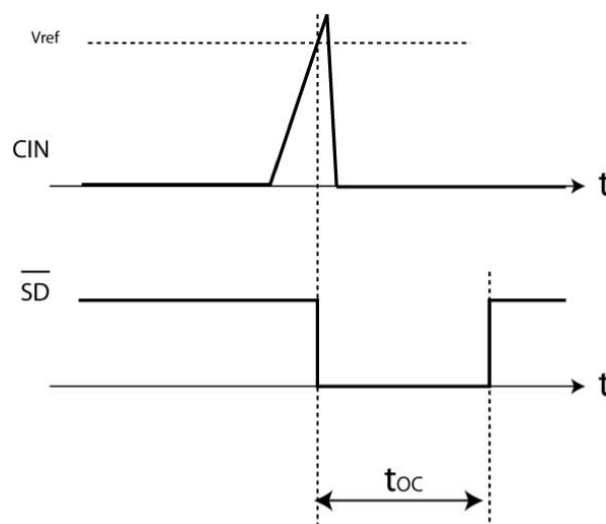

GIPG120520141638FSR

Figure 5. UVLO timing (without contribution of the RC network on  $\overline{SD}$ )



GIPG120520141644FSR

## 4.1 Smart shutdown function

The device integrates a comparator committed to the fault sensing function. The comparator input can be connected to an external shunt resistor in order to implement a simple overcurrent detection function.

The output signal of the comparator is fed to an integrated MOSFET with the open drain output available on the  $\overline{SD}$  input. When the comparator triggers, the device is set in shutdown state and its outputs are all set to low level.

**Figure 6. Smart shutdown timing waveforms in case of overcurrent event**

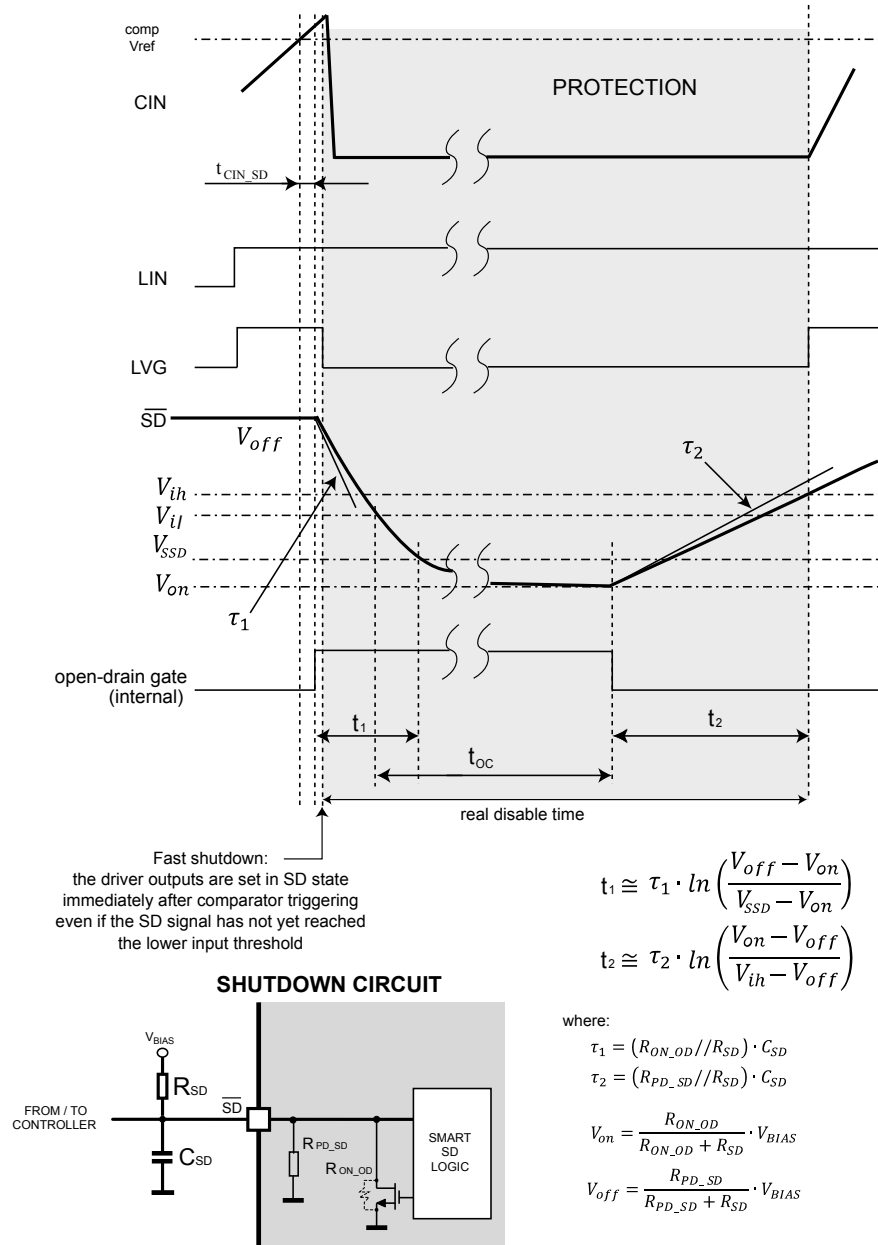

$R_{ON\_OD} = V_{OD}/5 \text{ mA}$ , see Table 10. Sense comparator ( $V_{CC} = 15 \text{ V}$ , unless otherwise is specified);

$R_{PD\_SD} (\text{typ.}) = 5 \text{ V}/I_{SDh}$

In common overcurrent protection designs, the comparator output is usually connected to the  $\overline{SD}$  input and an RC network is connected to this  $\overline{SD}$  line in order to provide a mono-stable circuit which implements a protection time that follows the fault condition.

As opposed to common fault detection systems, the device smart shutdown architecture allows the immediate turn-off of output gates driver in case of fault, by minimizing the propagation delay between the fault detection event and the actual switching off of the outputs. In fact, the time delay between the fault and the turning off of the outputs is no longer dependent on the RC value of the external network connected to the pin.

In the smart shutdown circuitry, the fault signal has a preferential path which directly switches off the outputs after the comparator triggering.

At the same time, the internal logic turns on the open-drain output and holds it on until the  $\overline{SD}$  voltage goes below the  $V_{SSD}$  threshold and the  $t_{oc}$  time is elapsed.

The driver outputs restart following the input pins as soon as the voltage at the  $\overline{SD}$  pin reaches the higher threshold of the  $\overline{SD}$  logic input.

The smart shutdown system provides the possibility to increase the time constant of the external RC network (i.e., the disable time after the fault event) up to very high values without increasing the delay time of the protection.

## 5 Temperature monitoring solutions

### 5.1 TSO output

The device integrates a temperature sensor. A voltage proportional to the die temperature is available on the TSO pin. When this function is not used, the pin can be left floating.

Figure 7.  $V_{TSO}$  output characteristics vs LVIC temperature

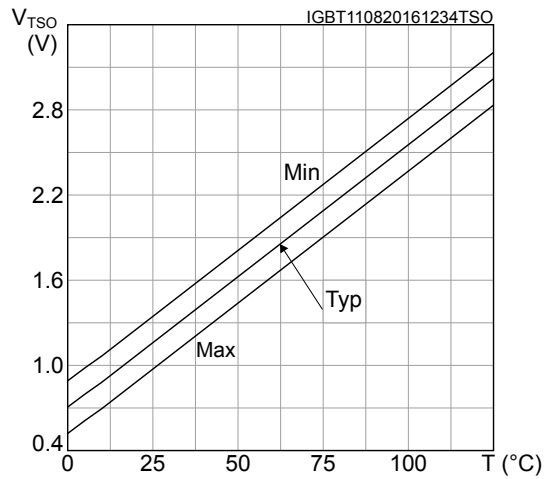

### 5.2 NTC thermistor

Table 12. NTC thermistor

Symbol	Parameter	Test condition	Min.	Typ.	Max.	Unit
$R_{25}$	Resistance	$T = 25\text{ }^{\circ}\text{C}$		85		$\text{k}\Omega$
$R_{125}$	Resistance	$T = 125\text{ }^{\circ}\text{C}$		2.6		$\text{k}\Omega$
B	B-constant	$T = 25\text{ to }100\text{ }^{\circ}\text{C}$		4092		K
T	Operating temperature range		-40		125	$^{\circ}\text{C}$

Figure 8. NTC resistance vs temperature

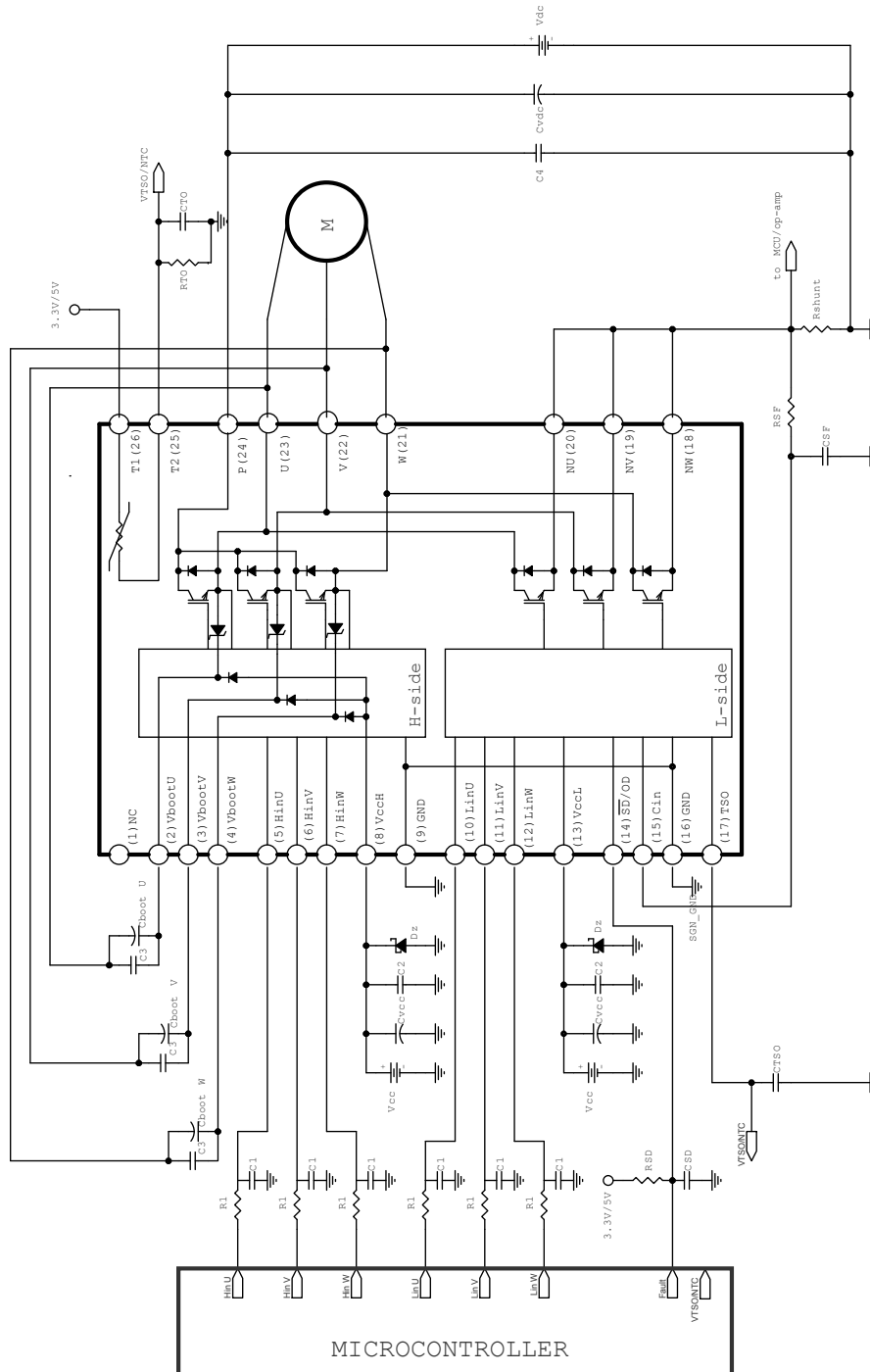

Figure 9. NTC resistance vs temperature - zoom



## 6 Application circuit example

Figure 10. Application circuit example



GADG310320201430GT

Application designers are free to use a different scheme according to the device specifications.



## 6.1 Guidelines

1. Input signals HIN, LIN are active-high logic. A 100 k $\Omega$  (typ.) pull-down resistor is built-in for each input pin. To prevent input signal oscillations, the wiring of each input should be as short as possible and the use of RC filters ( $R_1$ ,  $C_1$ ) on each input signal is suggested. The filters should be with a time constant of about 100 ns and placed as close as possible to the IPM input pins.
2. The use of a bypass capacitor  $C_{VCC}$  (aluminum or tantalum) can reduce the transient circuit demand on the power supply. Besides, to reduce any high-frequency switching noise distributed on the power lines, a decoupling capacitor  $C_2$  (100 to 220 nF, with low ESR and low ESL) should be placed as close as possible to each  $V_{CC}$  pin and in parallel with the bypass capacitor.
3. The use of an RC filter ( $R_{SF}$ ,  $C_{SF}$ ) prevents protection circuit malfunctions. The time constant ( $R_{SF} \times C_{SF}$ ) should be set to 1  $\mu$ s and the filter must be placed as close as possible to the CIN pin.
4. The  $\overline{SD}$  is an input/output pin (open-drain type if it is used as output). It should be pulled up to a power supply (i.e., MCU bias at 3.3/5 V) by a resistor value, which can keep the  $I_{od}$  no higher than 5 mA ( $V_{OD} \leq 500$  mV when open-drain MOSFET is ON). The filter on  $\overline{SD}$  should be sized to get a desired re-starting time after a fault event and placed as close as possible to the  $\overline{SD}$  pin.
5. A decoupling capacitor  $C_{TSO}$  between 1 nF and 10 nF can be used to increase the noise immunity of the TSO thermal sensor; a similar decoupling capacitor  $C_{OT}$  (between 10 nF and 100 nF) can be implemented if the NTC thermistor is available and used. In both cases, their effectiveness is improved if these capacitors are placed close to the MCU.
6. The decoupling capacitor  $C_3$  (100 to 220 nF with low ESR and low ESL) in parallel with each  $C_{boot}$  filters high-frequency disturbances. Both  $C_{boot}$  and  $C_3$  (if present) should be placed as close as possible to the U,V,W and  $V_{boot}$  pins. Bootstrap negative electrodes should be connected to the U,V,W terminals directly and separated from the main output wires.
7. To prevent overvoltage on the  $V_{CC}$  pin, a Zener diode (Dz) can be used.
8. The use of the decoupling capacitor  $C_4$  (100 to 220 nF, with low ESR and low ESL) in parallel with the electrolytic capacitor  $C_{Vdc}$  prevents surge destruction. Both capacitors  $C_4$  and  $C_{Vdc}$  should be placed as close as possible to the IPM ( $C_4$  has priority over  $C_{Vdc}$ ).
9. By integrating an application-specific type HVIC inside the module, direct coupling to the MCU terminals without an optocoupler is possible.
10. Low inductance shunt resistors should be used for phase leg current sensing.
11. In order to avoid malfunctions, the wiring on N pins, the shunt resistor and PWR\_GND should be as short as possible.
12. The connection of the SGN\_GND to the PWR\_GND at one point only (close to the shunt resistor terminal) can reduce the impact of power ground fluctuation.

These guidelines ensure the device specifications for application designs. For further details, please refer to the relevant application note.

**Table 13. Recommended operating conditions**

Symbol	Parameter	Test conditions	Min.	Typ.	Max.	Unit
$V_{PN}$	Supply voltage	Applied between P-Nu, $N_V$ , $N_W$		300	400	V
$V_{CC}$	Control supply voltage	Applied between $V_{CC}$ -GND	13.5	15	18	V
$V_{BS}$	High-side bias voltage	Applied between $V_{BOOTi}$ - $OUT_i$ for $i = U, V, W$	13		18	V
$t_{dead}$	Blanking time to prevent arm-short	For each input signal	1.0			$\mu$ s
$f_{PWM}$	PWM input signal	$-40^\circ\text{C} < T_C < 100^\circ\text{C}$ $-40^\circ\text{C} < T_J < 125^\circ\text{C}$			20	kHz
$T_C$	Case operation temperature				100	$^\circ\text{C}$

## 7 Electrical characteristics (curves)

**Figure 11. Output characteristics**

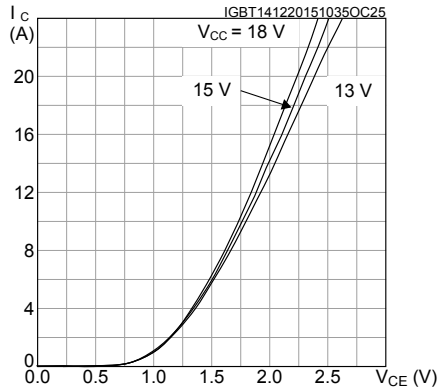

**Figure 12.  $V_{CE(sat)}$  vs collector current**

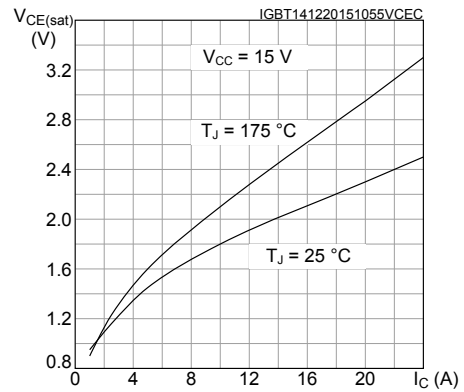

**Figure 13.  $I_C$  vs case temperature**

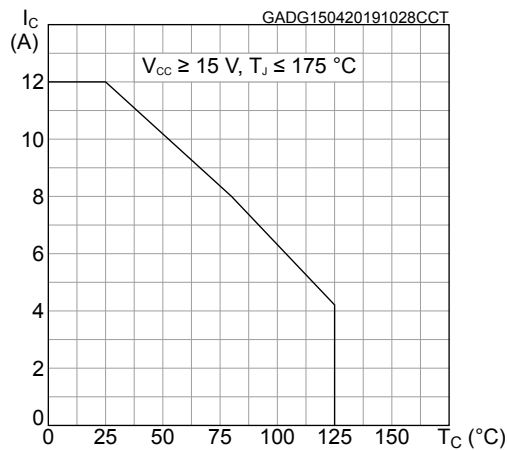

**Figure 14. Diode  $V_F$  vs forward current**

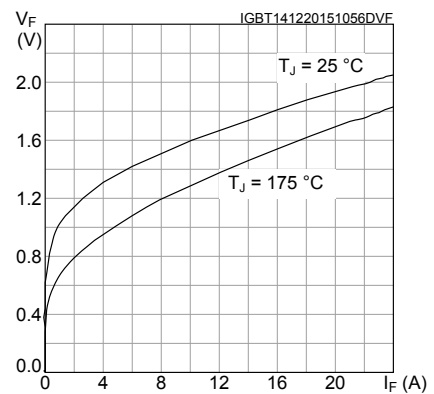

**Figure 15.  $E_{on}$  switching energy vs collector current**

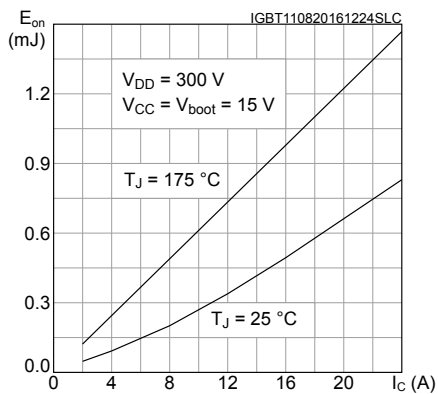

**Figure 16.  $E_{off}$  switching energy vs collector current**

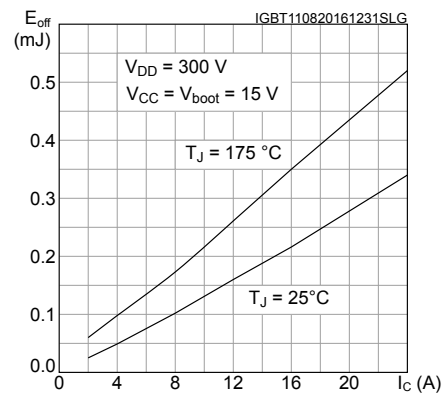

**Figure 17. Thermal impedance**

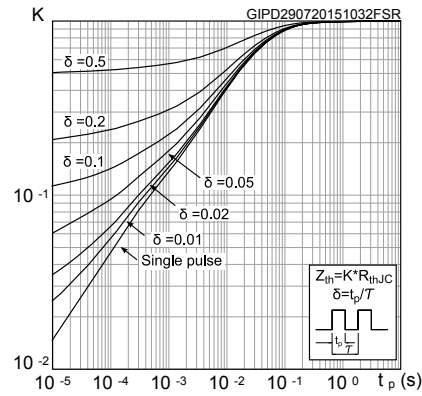

## 8 Package information

In order to meet environmental requirements, ST offers these devices in different grades of **ECOPACK** packages, depending on their level of environmental compliance. ECOPACK specifications, grade definitions and product status are available at: [www.st.com](http://www.st.com). ECOPACK is an ST trademark.

### 8.1 SDIP2B-26L type X package information

Figure 18. SDIP2B-26L type X package outline

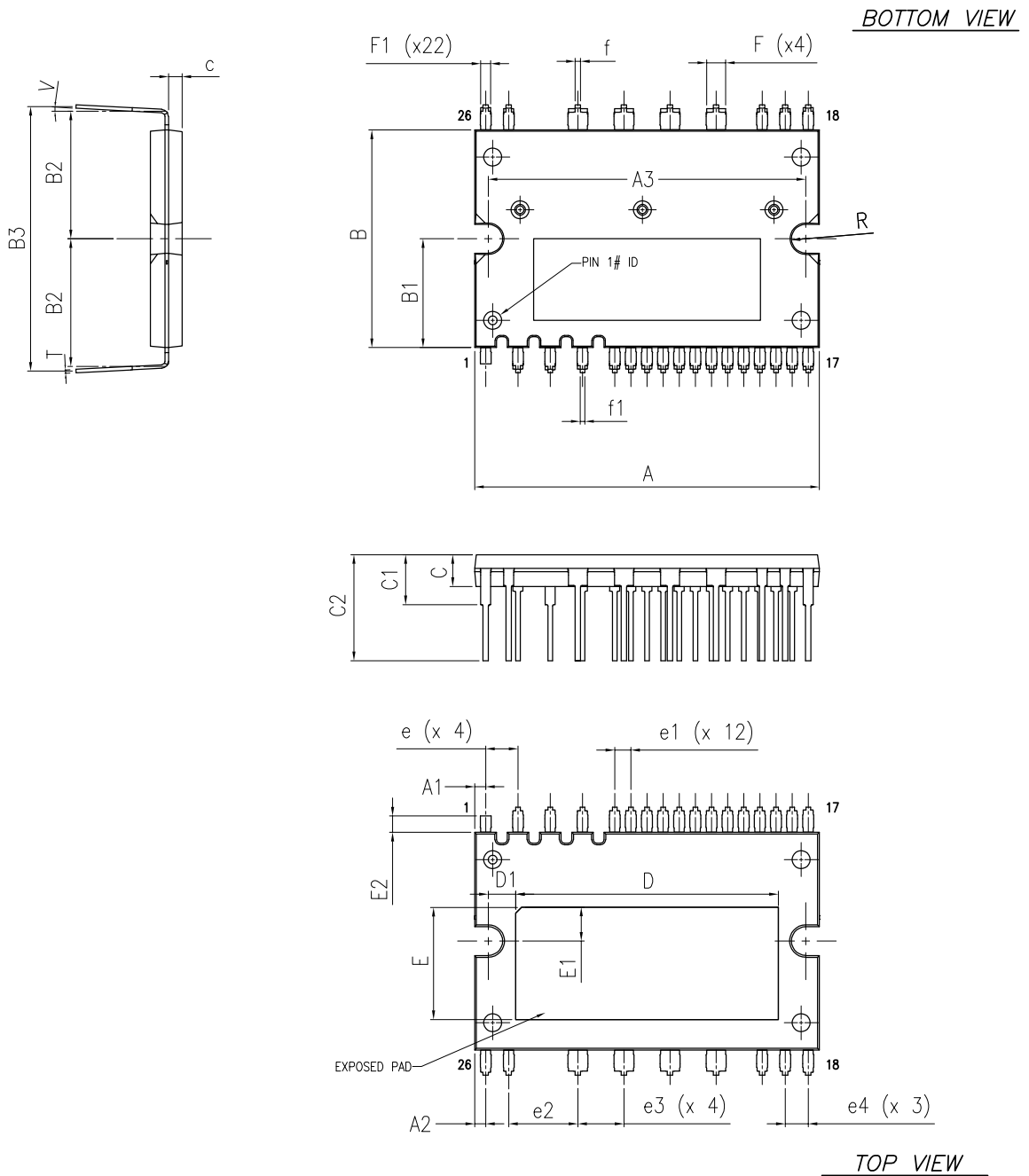

8450802\_7\_type\_X

**Table 14. SDIP2B-26L type X package mechanical data**

Ref.	Dimensions (mm)		
	Min.	Typ.	Max.
A	37.50	38.00	38.50
A1	0.97	1.22	1.47
A2	0.97	1.22	1.47
A3	34.70	35.00	35.30
c	1.45	1.50	1.55
B	23.50	24.00	24.50
B1		12.00	
B2	13.90	14.40	14.90
B3	28.80	29.30	29.80
C	3.30	3.50	3.70
C1	5.00	5.50	6.00
C2	11.20	11.70	12.20
D	28.45	28.95	29.45
D1	2.725	3.025	3.325
e	3.356	3.556	3.756
e1	1.578	1.778	1.978
e2	7.42	7.62	7.82
e3	4.88	5.08	5.28
e4	2.34	2.54	2.74
E	11.90	12.40	12.90
E1	3.45	3.75	4.05
E2		1.80	
f	0.45	0.60	0.75
f1	0.35	0.50	0.65
F	1.95	2.10	2.25
F1	0.95	1.10	1.25
R	1.55	1.575	1.60
T	0.375	0.40	0.425
V	0°		5°

## Revision history

**Table 15. Document revision history**

Date	Revision	Changes
29-Oct-2021	1	First release.

## Contents

<b>1</b>	<b>Internal schematic and pin description</b>	<b>2</b>
<b>2</b>	<b>Absolute maximum ratings</b>	<b>4</b>
2.1	Thermal data	5
<b>3</b>	<b>Electrical characteristics</b>	<b>6</b>
3.1	Inverter part	6
3.2	Control/protection parts	8
<b>4</b>	<b>Fault management</b>	<b>10</b>
4.1	Smart shutdown function	12
<b>5</b>	<b>Temperature monitoring solutions</b>	<b>14</b>
5.1	TSO output	14
5.2	NTC thermistor	14
<b>6</b>	<b>Application circuit example</b>	<b>16</b>
6.1	Guidelines	17
<b>7</b>	<b>Electrical characteristics (curves)</b>	<b>18</b>
<b>8</b>	<b>Package information</b>	<b>20</b>
8.1	SDIP2B-26L type X package information	20
	<b>Revision history</b>	<b>22</b>