

Trench gate field-stop 600 V, 30 A high speed HB series IGBT

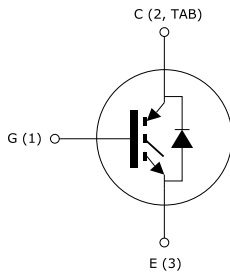
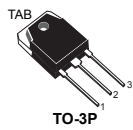
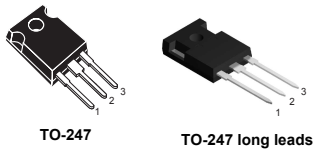

Features

- Maximum junction temperature: $T_J = 175\text{ }^\circ\text{C}$
- High speed switching series
- Minimized tail current
- Low saturation voltage: $V_{CE(sat)} = 1.55\text{ V (typ.) @ } I_C = 30\text{ A}$
- Tight parameter distribution
- Safe paralleling
- Positive $V_{CE(sat)}$ temperature coefficient
- Low thermal resistance
- Very fast soft recovery antiparallel diode

Applications

- Photovoltaic inverters
- High frequency converters

Description

These devices are IGBTs developed using an advanced proprietary trench gate field-stop structure. These devices are part of the new HB series of IGBTs, which represent an optimum compromise between conduction and switching loss to maximize the efficiency of any frequency converter. Furthermore, the slightly positive $V_{CE(sat)}$ temperature coefficient and very tight parameter distribution result in safer paralleling operation.

Product status link

[STGW30H60DFB](#)
[STGWA30H60DFB](#)
[STGWT30H60DFB](#)

1 Electrical ratings

Table 1. Absolute maximum ratings

Symbol	Parameter	Value	Unit
V_{CES}	Collector-emitter voltage ($V_{GE} = 0$ V)	600	V
I_C	Continuous collector current at $T_C = 25$ °C	60	A
	Continuous collector current at $T_C = 100$ °C	30	
$I_{CP}^{(1)}$	Pulsed collector current	120	
V_{GE}	Gate-emitter voltage	±20	V
	Transient gate-emitter voltage	±30	
I_F	Continuous forward current at $T_C = 25$ °C	60	A
	Continuous forward current at $T_C = 100$ °C	30	
$I_{FP}^{(1)}$	Pulsed forward current	120	
P_{TOT}	Total power dissipation at $T_C = 25$ °C	260	W
T_{STG}	Storage temperature range	- 55 to 150	°C
T_J	Operating junction temperature range	- 55 to 175	

1. Pulse width limited by maximum junction temperature.

Table 2. Thermal data

Symbol	Parameter	Value	Unit
R_{thJC}	Thermal resistance junction-case IGBT	0.58	°C/W
R_{thJC}	Thermal resistance junction-case diode	2.08	
R_{thJA}	Thermal resistance junction-ambient	50	

2 Electrical characteristics

$T_C = 25\text{ °C}$ unless otherwise specified

Table 3. Static characteristics

Symbol	Parameter	Test conditions	Min.	Typ.	Max.	Unit
$V_{(BR)CES}$	Collector-emitter breakdown voltage	$V_{GE} = 0\text{ V}, I_C = 2\text{ mA}$	600			V
$V_{CE(sat)}$	Collector-emitter saturation voltage	$V_{GE} = 15\text{ V}, I_C = 30\text{ A}$		1.55	2	V
		$V_{GE} = 15\text{ V}, I_C = 30\text{ A}, T_J = 125\text{ °C}$		1.65		
		$V_{GE} = 15\text{ V}, I_C = 30\text{ A}, T_J = 175\text{ °C}$		1.75		
V_F	Forward on-voltage	$I_F = 30\text{ A}$		2	2.6	V
		$I_F = 30\text{ A}, T_J = 125\text{ °C}$		1.7		
		$I_F = 30\text{ A}, T_J = 175\text{ °C}$		1.6		
$V_{GE(th)}$	Gate threshold voltage	$V_{CE} = V_{GE}, I_C = 1\text{ mA}$	5	6	7	V
I_{CES}	Collector cut-off current	$V_{GE} = 0\text{ V}, V_{CE} = 600\text{ V}$			25	μA
I_{GES}	Gate-emitter leakage current	$V_{CE} = 0\text{ V}, V_{GE} = \pm 20\text{ V}$			± 250	nA

Table 4. Dynamic characteristics

Symbol	Parameter	Test conditions	Min.	Typ.	Max.	Unit
C_{ies}	Input capacitance	$V_{CE} = 25\text{ V}, f = 1\text{ MHz}, V_{GE} = 0\text{ V}$	-	3659	-	pF
C_{oes}	Output capacitance		-	101	-	
C_{res}	Reverse transfer capacitance		-	76	-	
Q_g	Total gate charge	$V_{CC} = 520\text{ V}, I_C = 30\text{ A}, V_{GE} = 0\text{ to }15\text{ V}$ (see Figure 28. Gate charge test circuit)	-	149	-	nC
Q_{ge}	Gate-emitter charge		-	25	-	
Q_{gc}	Gate-collector charge		-	62	-	

Table 5. IGBT switching characteristics (inductive load)

Symbol	Parameter	Test conditions	Min.	Typ.	Max.	Unit	
$t_{d(on)}$	Turn-on delay time	$V_{CE} = 400\text{ V}$, $I_C = 30\text{ A}$, $V_{GE} = 15\text{ V}$, $R_G = 10\ \Omega$ (see Figure 27 . Test circuit for inductive load switching)	-	37	-	ns	
t_r	Current rise time		-	14.6	-		
$(di/dt)_{on}$	Turn-on current slope		-	1643	-	A/ μ s	
$t_{d(off)}$	Turn-off-delay time		$V_{CE} = 400\text{ V}$, $I_C = 30\text{ A}$, $V_{GE} = 15\text{ V}$, $R_G = 10\ \Omega$, $T_J = 175\text{ }^\circ\text{C}$ (see Figure 27 . Test circuit for inductive load switching)	-	146	-	ns
t_f	Current fall time			-	23	-	
$E_{on}^{(1)}$	Turn-on switching energy			-	383	-	μ J
$E_{off}^{(2)}$	Turn-off switching energy			-	293	-	
E_{ts}	Total switching energy			-	676	-	
$t_{d(on)}$	Turn-on delay time			$V_{CE} = 400\text{ V}$, $I_C = 30\text{ A}$, $V_{GE} = 15\text{ V}$, $R_G = 10\ \Omega$, $T_J = 175\text{ }^\circ\text{C}$ (see Figure 27 . Test circuit for inductive load switching)	-	35	-
t_r	Current rise time	-			16.1	-	
$(di/dt)_{on}$	Turn-on current slope	-			1496	-	A/ μ s
$t_{d(off)}$	Turn-off-delay time	$V_{CE} = 400\text{ V}$, $I_C = 30\text{ A}$, $V_{GE} = 15\text{ V}$, $R_G = 10\ \Omega$, $T_J = 175\text{ }^\circ\text{C}$ (see Figure 27 . Test circuit for inductive load switching)			-	158	-
t_f	Current fall time		-		65	-	
$E_{on}^{(1)}$	Turn-on switching energy		-		794	-	μ J
$E_{off}^{(2)}$	Turn-off switching energy		-		572	-	
E_{ts}	Total switching energy		-		1366	-	

1. Including the reverse recovery of the diode.
2. Including the tail of the collector current.

Table 6. Diode switching characteristics (inductive load)

Symbol	Parameter	Test conditions	Min.	Typ.	Max.	Unit
t_{rr}	Reverse recovery time	$I_F = 30\text{ A}$, $V_R = 400\text{ V}$, $V_{GE} = 15\text{ V}$, $di/dt = 1000\text{ A}/\mu\text{s}$ (see Figure 27 . Test circuit for inductive load switching)	-	53	-	ns
Q_{rr}	Reverse recovery charge		-	384	-	nC
I_{rrm}	Reverse recovery current		-	14.5	-	A
di_{rr}/dt	Peak rate of fall of reverse recovery current during t_b		-	788	-	A/ μ s
E_{rr}	Reverse recovery energy		-	104	-	μ J
t_{rr}	Reverse recovery time	$I_F = 30\text{ A}$, $V_R = 400\text{ V}$, $V_{GE} = 15\text{ V}$, $di/dt = 1000\text{ A}/\mu\text{s}$, $T_J = 175\text{ }^\circ\text{C}$ (see Figure 27 . Test circuit for inductive load switching)	-	104	-	ns
Q_{rr}	Reverse recovery charge		-	1352	-	nC
I_{rrm}	Reverse recovery current		-	26	-	A
di_{rr}/dt	Peak rate of fall of reverse recovery current during t_b		-	310	-	A/ μ s
E_{rr}	Reverse recovery energy		-	407	-	μ J

2.1 Electrical characteristics (curves)

Figure 1. Power dissipation vs case temperature

Figure 2. Collector current vs case temperature

Figure 3. Output characteristics ($T_J = 25^\circ\text{C}$)

Figure 4. Output characteristics ($T_J = 175^\circ\text{C}$)

Figure 5. $V_{CE(sat)}$ vs junction temperature

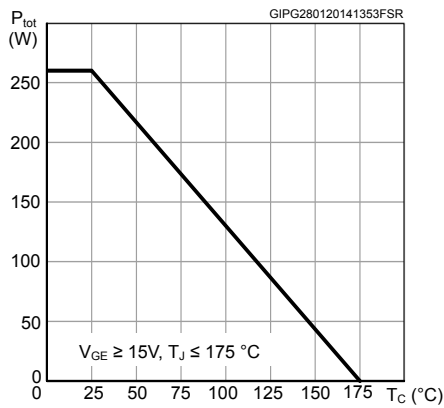
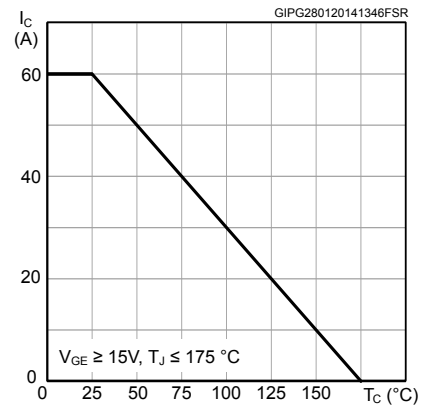
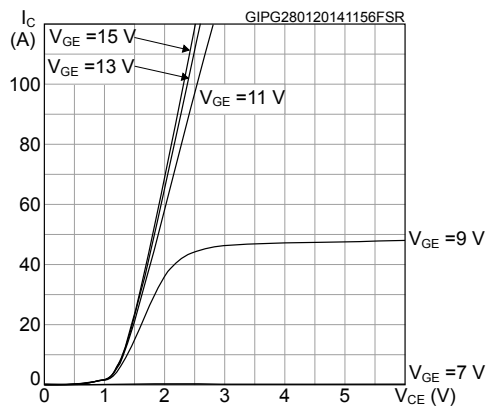
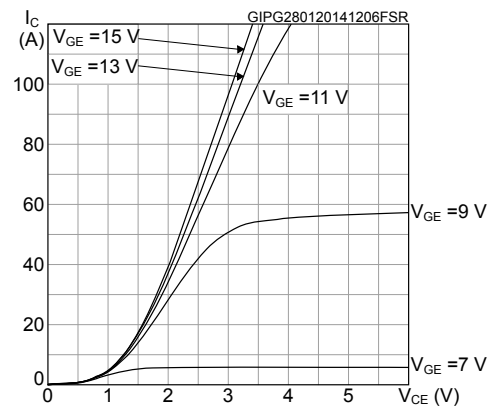
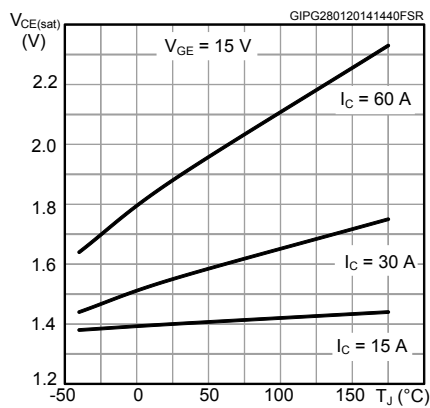
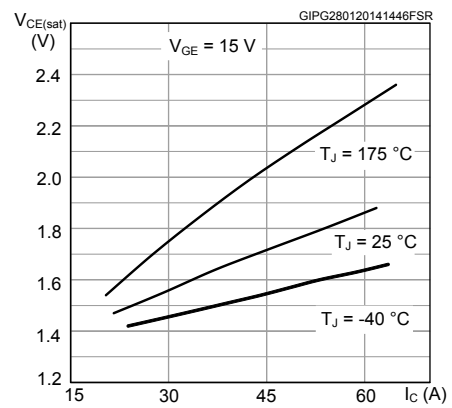
Figure 6. $V_{CE(sat)}$ vs collector current

Figure 7. Collector current vs switching frequency

Figure 8. Forward bias safe operating area

Figure 9. Transfer characteristics

Figure 10. Diode V_F vs forward current

Figure 11. Normalized V_{GE(th)} vs junction temperature

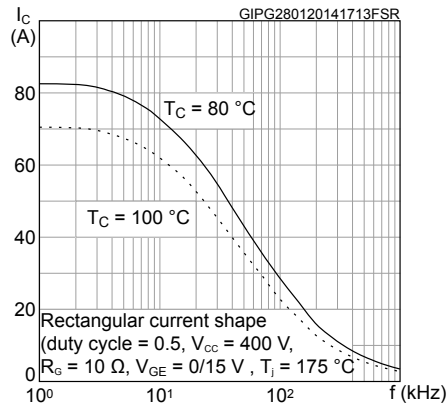
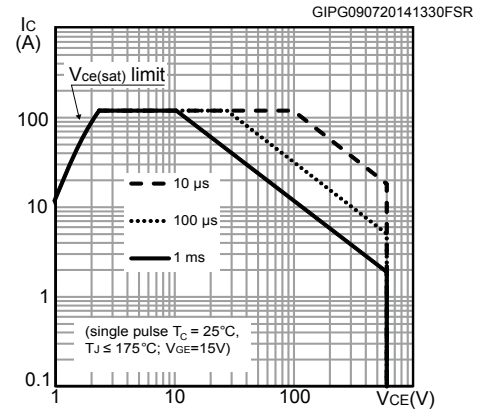
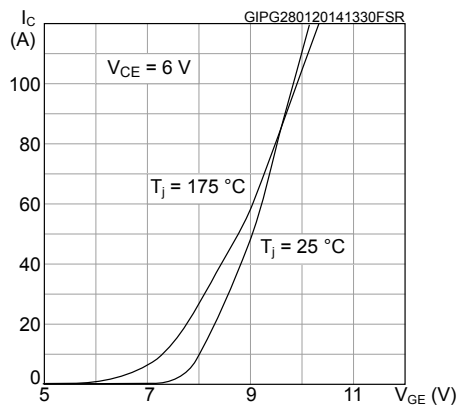
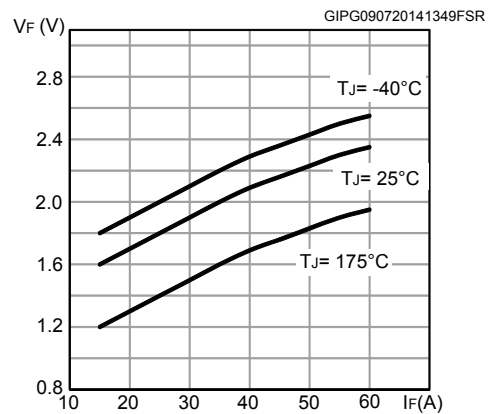
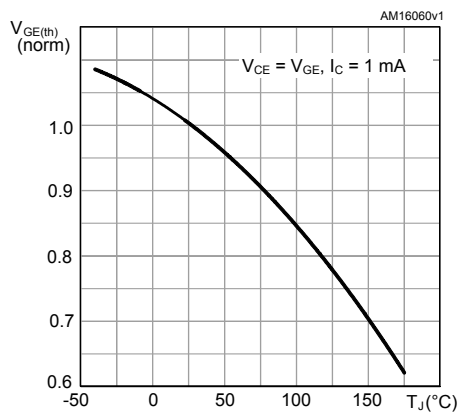
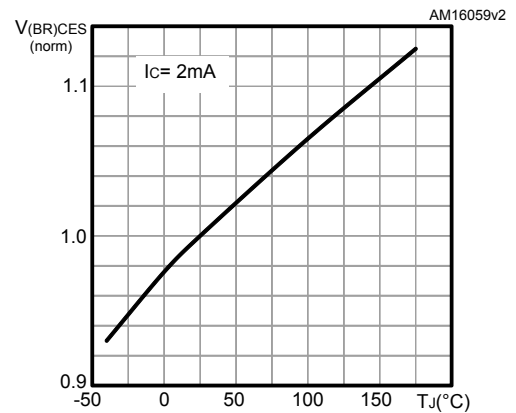
Figure 12. Normalized V_{(BR)CES} vs junction temperature

Figure 13. Capacitance variations

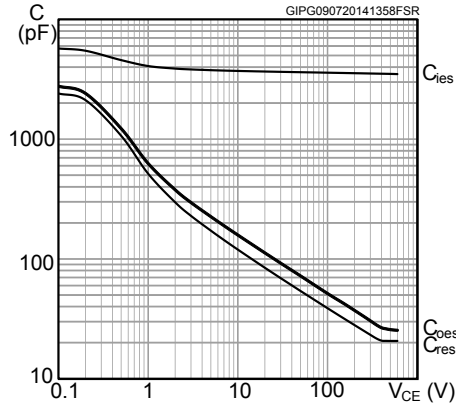

Figure 14. Gate charge vs. gate-emitter voltage

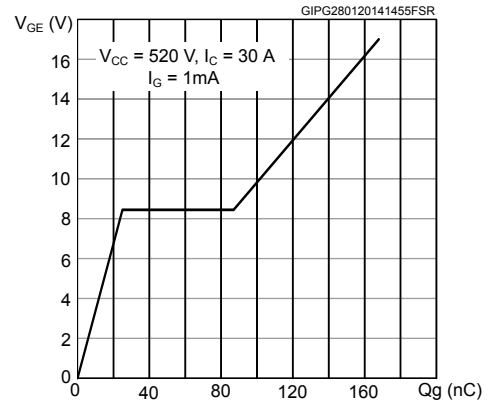

Figure 15. Switching energy vs collector current

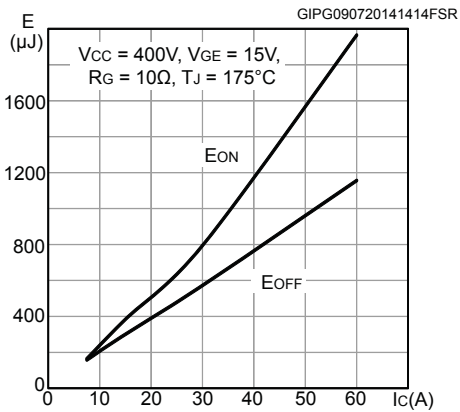

Figure 16. Switching energy vs gate resistance

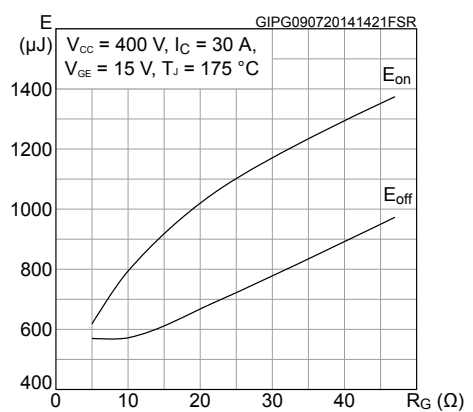

Figure 17. Switching energy vs temperature

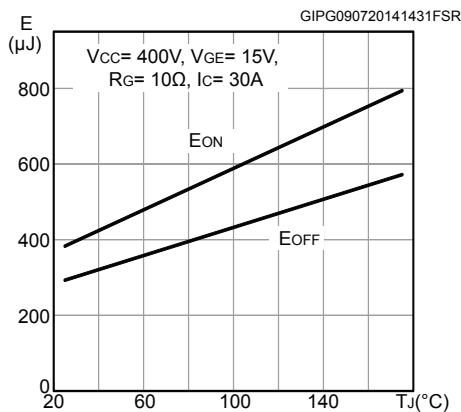

Figure 18. Switching energy vs collector emitter voltage

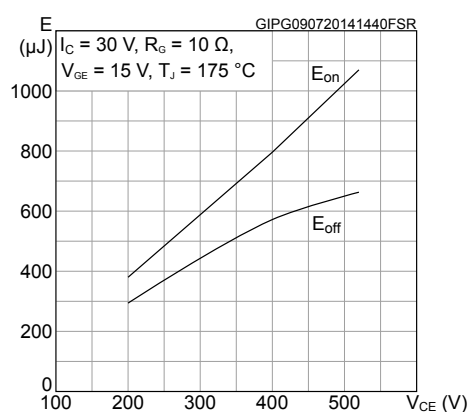

Figure 19. Switching times vs collector current

Figure 20. Switching times vs gate resistance

Figure 21. Reverse recovery current vs diode current slope

Figure 22. Reverse recovery time vs diode current slope

Figure 23. Reverse recovery charge vs diode current slope

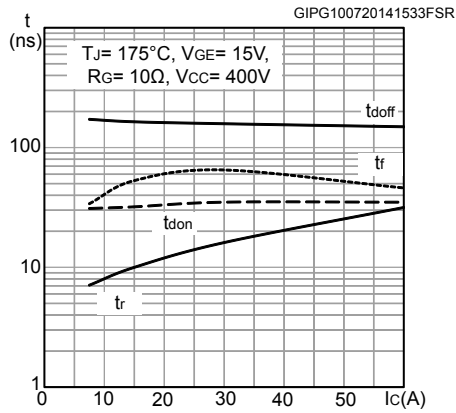
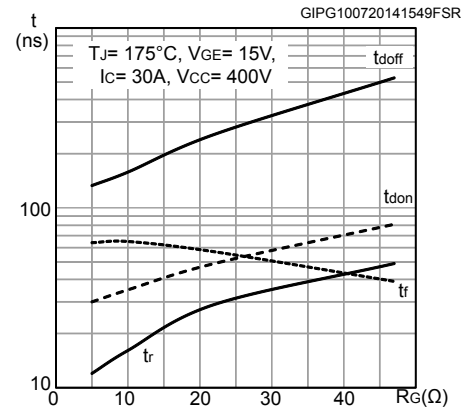
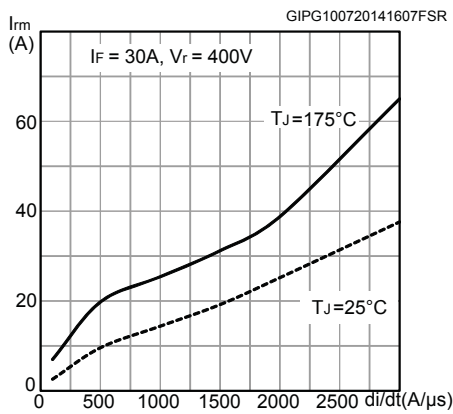
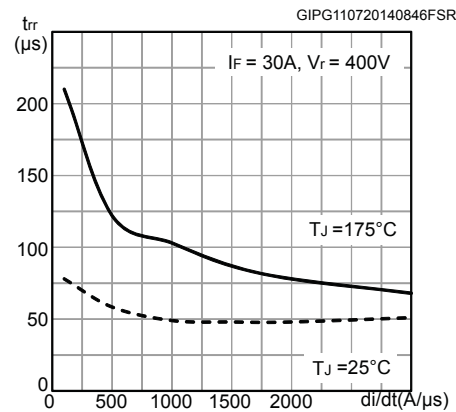
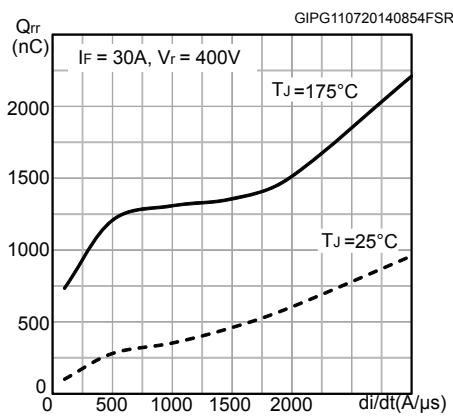
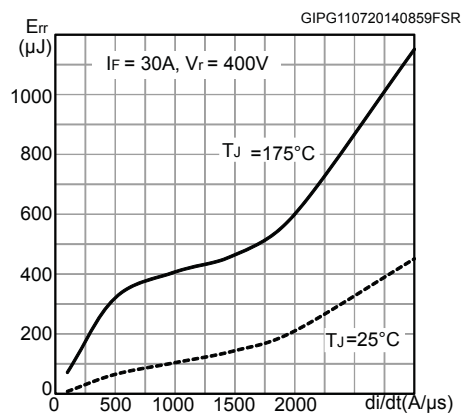
Figure 24. Reverse recovery energy vs diode current slope

Figure 25. Thermal impedance for IGBT

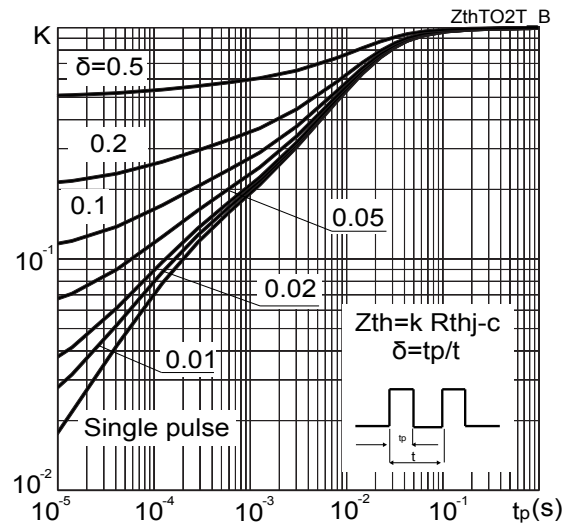
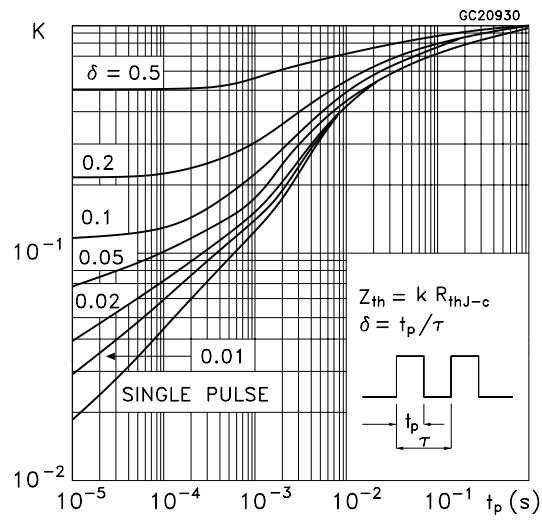

Figure 26. Thermal impedance for diode



3 Test circuits

Figure 27. Test circuit for inductive load switching

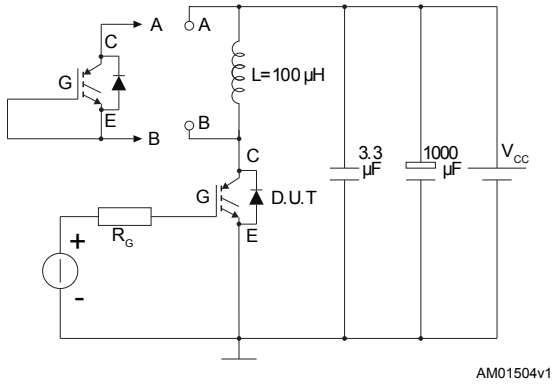

Figure 28. Gate charge test circuit

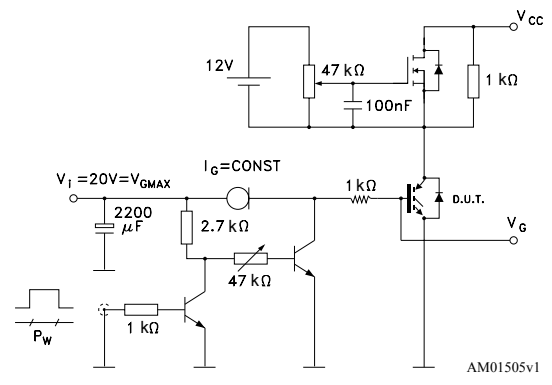

Figure 29. Switching waveform

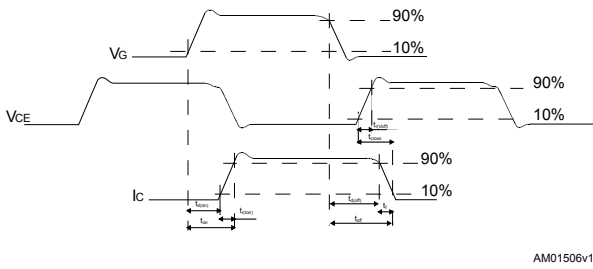
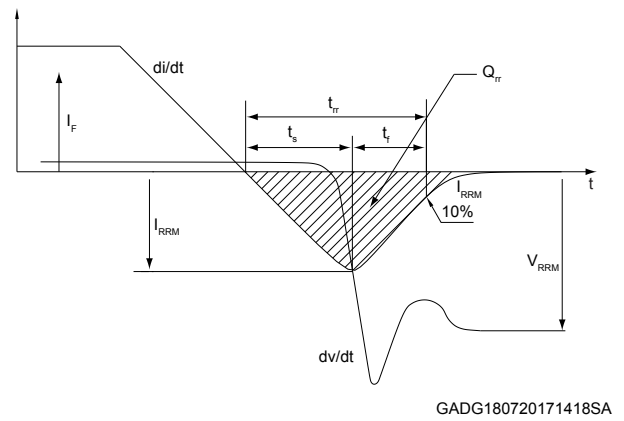

Figure 30. Diode reverse recovery waveform





4 Package information

In order to meet environmental requirements, ST offers these devices in different grades of **ECOPACK** packages, depending on their level of environmental compliance. ECOPACK specifications, grade definitions and product status are available at: www.st.com. ECOPACK is an ST trademark.

4.1 TO-247 package information

Figure 31. TO-247 package outline

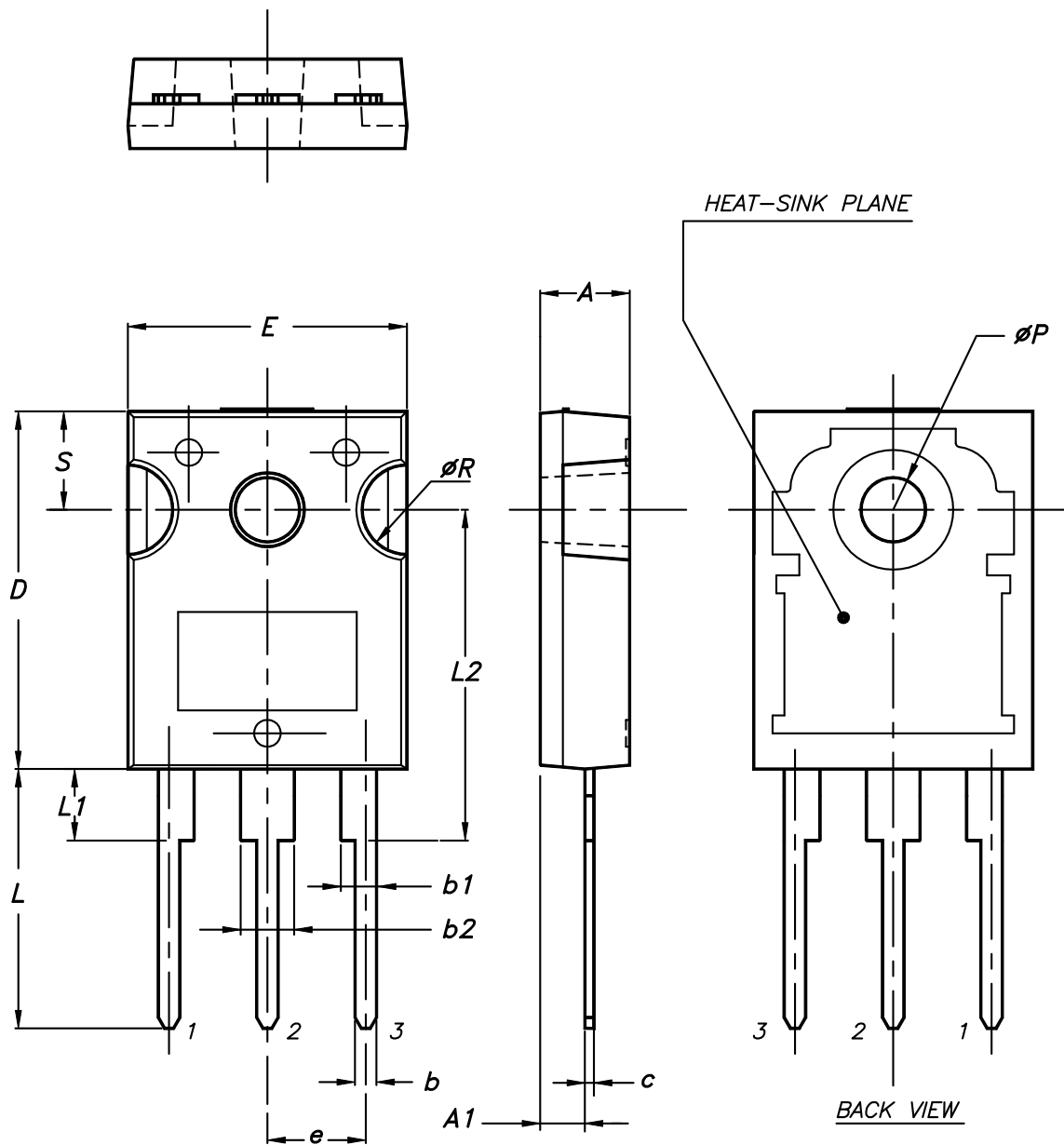

0075325_9

Table 7. TO-247 package mechanical data

Dim.	mm		
	Min.	Typ.	Max.
A	4.85		5.15
A1	2.20		2.60
b	1.0		1.40
b1	2.0		2.40
b2	3.0		3.40
c	0.40		0.80
D	19.85		20.15
E	15.45		15.75
e	5.30	5.45	5.60
L	14.20		14.80
L1	3.70		4.30
L2		18.50	
ØP	3.55		3.65
ØR	4.50		5.50
S	5.30	5.50	5.70

4.2 TO-247 long leads package information

Figure 32. TO-247 long leads package outline

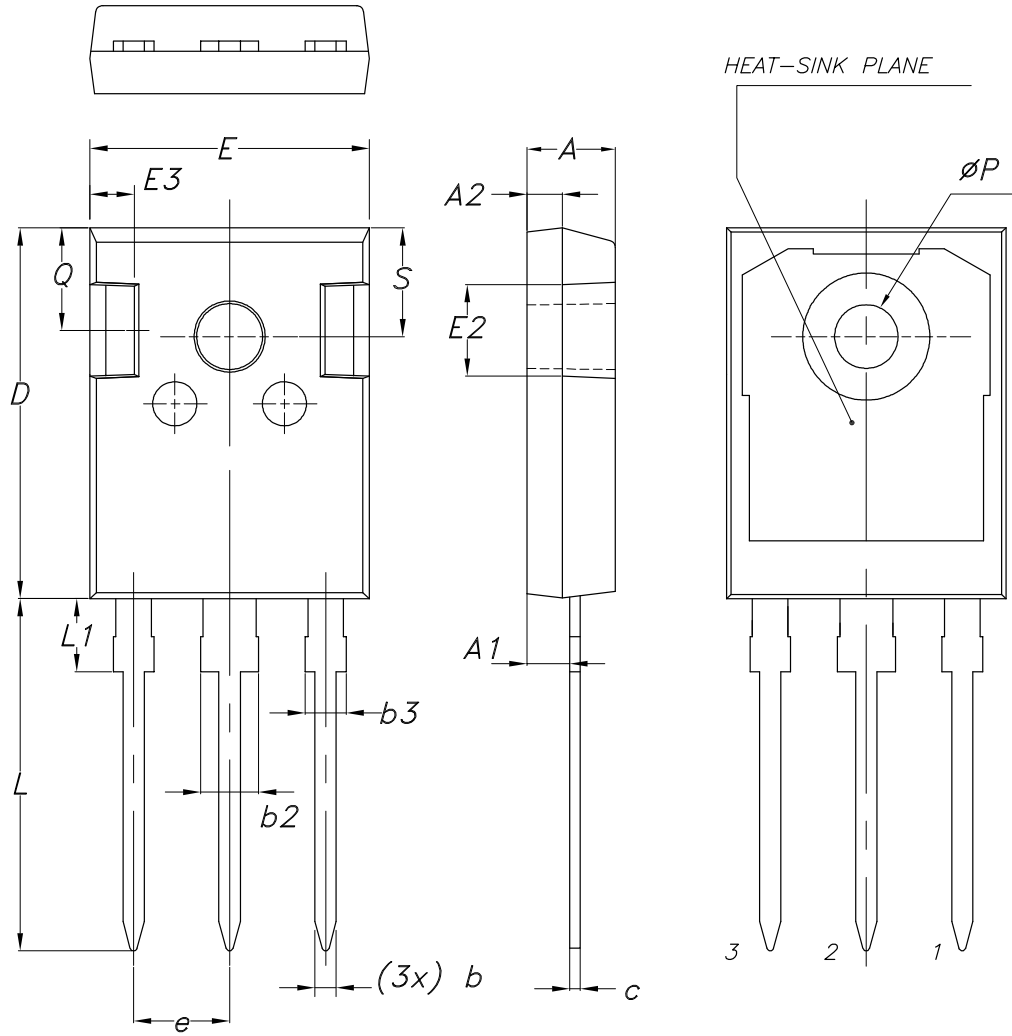

8463846_2_F

Table 8. TO-247 long leads package mechanical data

Dim.	mm		
	Min.	Typ.	Max.
A	4.90	5.00	5.10
A1	2.31	2.41	2.51
A2	1.90	2.00	2.10
b	1.16		1.26
b2			3.25
b3			2.25
c	0.59		0.66
D	20.90	21.00	21.10
E	15.70	15.80	15.90
E2	4.90	5.00	5.10
E3	2.40	2.50	2.60
e	5.34	5.44	5.54
L	19.80	19.92	20.10
L1			4.30
P	3.50	3.60	3.70
Q	5.60		6.00
S	6.05	6.15	6.25

4.3 TO-3P package information

Figure 33. TO-3P package outline

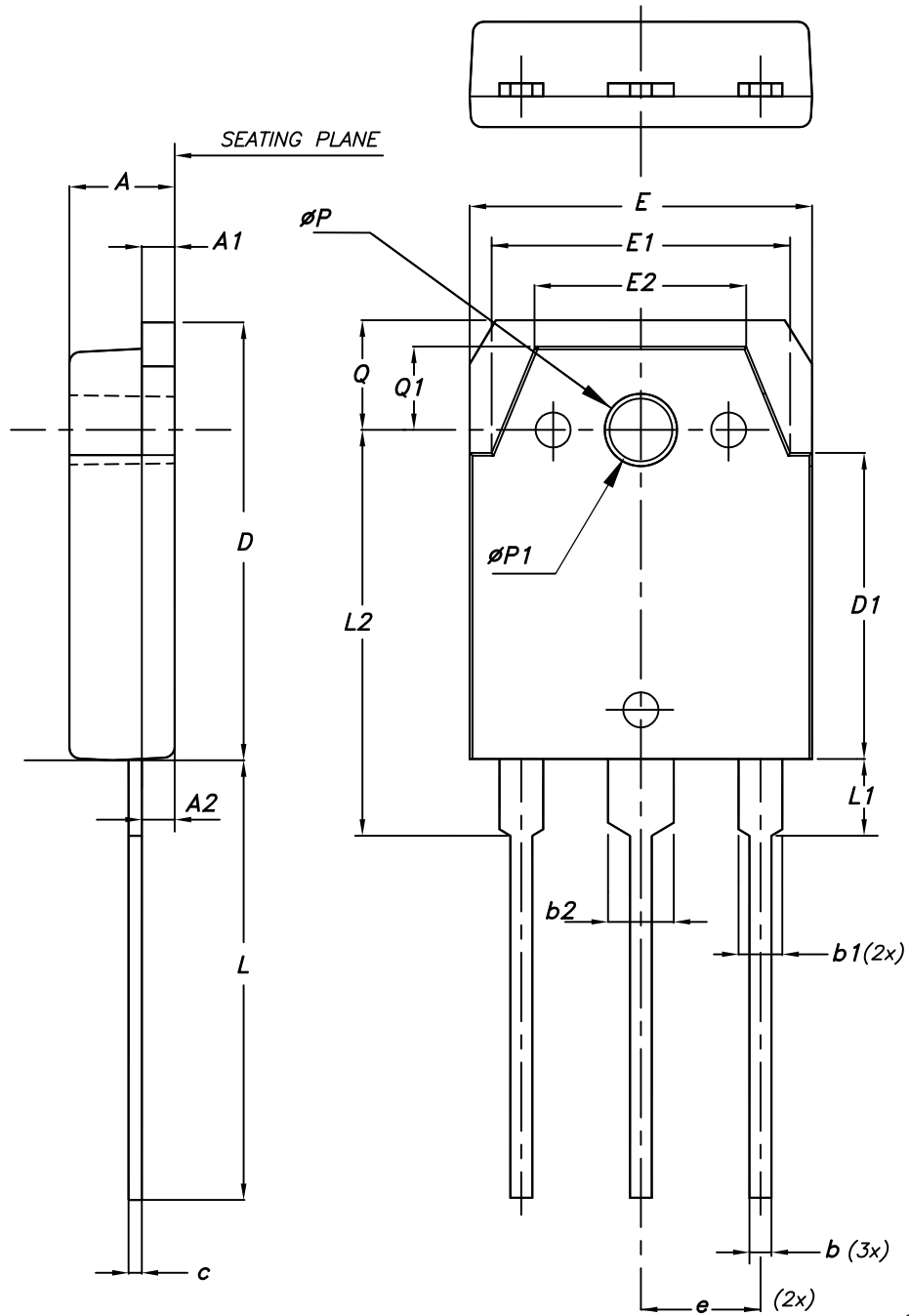

8045950_3

Table 9. TO-3P package mechanical data

Dim.	mm		
	Min.	Typ.	Max.
A	4.60	4.80	5.00
A1	1.45	1.50	1.65
A2	1.20	1.40	1.60
b	0.80	1.00	1.20
b1	1.80	2.00	2.20
b2	2.80	3.00	3.20
c	0.55	0.60	0.75
D	19.70	19.90	20.10
D1	13.70	13.90	14.10
E	15.40	15.60	15.80
E1	13.40	13.60	13.80
E2	9.40	9.60	9.90
e	5.15	5.45	5.75
L	19.80	20.00	20.20
L1	3.30	3.50	3.70
L2	18.20	18.40	18.60
ØP	3.30	3.40	3.50
ØP1	3.10	3.20	3.30
Q	4.80	5.00	5.20
Q1	3.60	3.80	4.00

5 Ordering information

Table 10. Order codes

Order code	Marking	Package	Packing
STGW30H60DFB	GW30H60DFB	TO-247	Tube
STGWA30H60DFB	GWA30H60DFB	TO-247 long leads	
STGWT30H60DFB	GWT30H60DFB	TO-3P	

Revision history

Table 11. Document revision history

Date	Revision	Changes
01-Aug-2014	1	Initial version.
17-Feb-2016	2	Modified: <i>Table 2, Table 4 and 6</i> Modified: <i>Figure 16</i> Updated: <i>Section 3</i> Updated: <i>Section 4.1: TO-247, STGW30H60DFB</i> Minor text changes
04-Nov-2016	3	Added device in TO-247 long leads. Document updated accordingly. Minor text changes.
10-May-2019	4	Modified Figure 3. Output characteristics ($T_J = 25\text{ }^\circ\text{C}$) , Figure 4. Output characteristics ($T_J = 175\text{ }^\circ\text{C}$) , Figure 9. Transfer characteristics , Figure 7. Collector current vs switching frequency , Figure 18. Switching energy vs collector emitter voltage . Minor text changes.

Contents

1	Electrical ratings	2
2	Electrical characteristics	3
2.1	Electrical characteristics (curves)	5
3	Test circuits	10
4	Package mechanical data	11
4.1	TO-247 package information	11
4.2	TO-247 long leads package information	13
4.3	TO-3P package information	15
5	Ordering information	18
	Revision history	19