

Trench gate field-stop IGBT, V series 600 V, 40 A very high speed

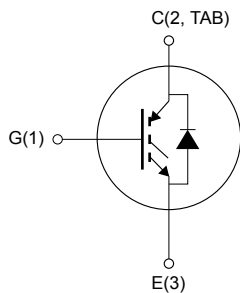

NG1E3C2T

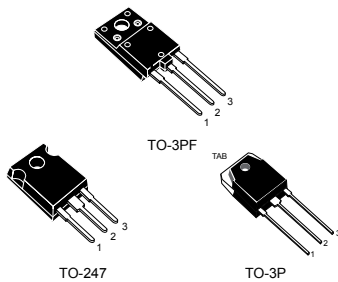

Features

- Maximum junction temperature: $T_J = 175\text{ °C}$
- Tail-less switching off
- $V_{CE(sat)} = 1.8\text{ V (typ.) @ } I_C = 40\text{ A}$
- Tight parameters distribution
- Safe paralleling
- Low thermal resistance
- Very fast soft recovery antiparallel diode

Applications

- Welding
- Power factor correction
- UPS
- Solar inverters
- Chargers

Description

These devices are IGBTs developed using an advanced proprietary trench gate field-stop structure. These devices are part of the V series IGBTs, which represent an optimum compromise between conduction and switching losses to maximize the efficiency of very high frequency converters. Furthermore, the positive $V_{CE(sat)}$ temperature coefficient and very tight parameter distribution result in safer paralleling operation.

Product status links

[STGFW40V60DF](#)
[STGW40V60DF](#)
[STGWT40V60DF](#)

1 Electrical ratings

Table 1. Absolute maximum ratings

Symbol	Parameter	Value		Unit
		TO-247, TO-3P	TO-3PF	
V_{CES}	Collector-emitter voltage ($V_{GE} = 0\text{ V}$)	600		V
I_C	Continuous collector current at $T_C = 25\text{ °C}$	80		A
	Continuous collector current at $T_C = 100\text{ °C}$	40		A
$I_{CP}^{(1)}$	Pulsed collector current	160		A
V_{GE}	Gate-emitter voltage	±20		V
I_F	Continuous forward current at $T_C = 25\text{ °C}$	80		A
	Continuous forward current at $T_C = 100\text{ °C}$	40		A
$I_{FP}^{(1)}$	Pulsed forward current	160		A
P_{TOT}	Total power dissipation at $T_C = 25\text{ °C}$	283	62.5	W
V_{ISO}	Insulation withstand voltage (RMS) from all three leads to external heat sink ($t = 1\text{ s}$; $T_C = 25\text{ °C}$)		3.5	kV
T_{stg}	Storage temperature range	-55 to 150		°C
T_J	Operating junction temperature range	-55 to 175		°C

1. Pulse width is limited by maximum junction temperature.

Table 2. Thermal data

Symbol	Parameter	Value		Unit
		TO-247, TO-3P	TO-3PF	
R_{thJC}	Thermal resistance junction-case IGBT	0.53	2.4	°C/W
R_{RthJC}	Thermal resistance junction-case diode	1.14	2.6	°C/W
R_{RthJA}	Thermal resistance junction-ambient	50		°C/W

2 Electrical characteristics

$T_J = 25\text{ °C}$ unless otherwise specified

Table 3. Static characteristics

Symbol	Parameter	Test conditions	Min.	Typ.	Max.	Unit
$V_{(BR)CES}$	Collector-emitter breakdown voltage	$V_{GE} = 0\text{ V}$, $I_C = 2\text{ mA}$	600			V
$V_{CE(sat)}$	Collector-emitter saturation voltage	$V_{GE} = 15\text{ V}$, $I_C = 40\text{ A}$		1.8	2.3	V
		$V_{GE} = 15\text{ V}$, $I_C = 40\text{ A}$, $T_J = 125\text{ °C}$		2.15		
		$V_{GE} = 15\text{ V}$, $I_C = 40\text{ A}$, $T_J = 175\text{ °C}$		2.35		
V_F	Forward on-voltage	$I_F = 40\text{ A}$		1.7	2.45	V
		$I_F = 40\text{ A}$, $T_J = 125\text{ °C}$		1.4		
		$I_F = 40\text{ A}$, $T_J = 175\text{ °C}$		1.3		
$V_{GE(th)}$	Gate threshold voltage	$V_{CE} = V_{GE}$, $I_C = 1\text{ mA}$	5	6	7	V
I_{CES}	Collector cut-off current	$V_{GE} = 0\text{ V}$, $V_{CE} = 0\text{ V}$			25	μA
I_{GES}	Gate-emitter leakage current	$V_{CE} = 0\text{ V}$, $V_{GE} = \pm 20\text{ V}$			± 250	nA

Table 4. Dynamic characteristics

Symbol	Parameter	Test conditions	Min.	Typ.	Max.	Unit
C_{ies}	Input capacitance	$V_{CE} = 25\text{ V}$, $f = 1\text{ MHz}$, $V_{GE} = 0\text{ V}$	-	5400	-	pF
C_{oes}	Output capacitance		-	220	-	pF
C_{res}	Reverse transfer capacitance		-	180	-	pF
Q_g	Total gate charge	$V_{CC} = 480\text{ V}$, $I_C = 40\text{ A}$, $V_{GE} = 0\text{ to }15\text{ V}$ (see Figure 34. Gate charge test circuit)	-	226	-	nC
Q_{ge}	Gate-emitter charge		-	38	-	nC
Q_{gc}	Gate-collector charge		-	95	-	nC

Table 5. IGBT switching characteristics (inductive load)

Symbol	Parameter	Test conditions	Min.	Typ.	Max.	Unit
$t_{d(on)}$	Turn-on delay time	$V_{CE} = 400\text{ V}$, $I_C = 40\text{ A}$, $R_G = 10\ \Omega$, $V_{GE} = 15\text{ V}$ (see Figure 33. Test circuit for inductive load switching)	-	52	-	ns
t_r	Current rise time		-	17	-	ns
$(di/dt)_{on}$	Turn-on current slope		-	1850	-	A/ μ s
$t_{d(off)}$	Turn-off delay time		-	208	-	ns
t_f	Current fall time		-	20	-	ns
$E_{on}^{(1)}$	Turn-on switching energy		-	456	-	μ J
$E_{off}^{(2)}$	Turn-off switching energy		-	411	-	μ J
E_{ts}	Total switching energy		-	867	-	μ J
$t_{d(on)}$	Turn-on delay time		$V_{CE} = 400\text{ V}$, $I_C = 40\text{ A}$, $R_G = 10\ \Omega$, $V_{GE} = 15\text{ V}$, $T_J = 175\text{ }^\circ\text{C}$ (see Figure 33. Test circuit for inductive load switching)	-	52	-
t_r	Current rise time	-		21	-	ns
$(di/dt)_{on}$	Turn-on current slope	-		1538	-	A/ μ s
$t_{d(off)}$	Turn-off-delay time	-		220	-	ns
t_f	Current fall time	-		21	-	ns
$E_{on}^{(1)}$	Turn-on switching energy	-		1330	-	μ J
$E_{off}^{(2)}$	Turn-off switching energy	-		560	-	μ J
E_{ts}	Total switching energy	-		1890	-	μ J

1. Including the reverse recovery of the diode.
2. Including the tail of the collector current.

Table 6. Diode switching characteristics (inductive load)

Symbol	Parameter	Test conditions	Min.	Typ.	Max.	Unit
t_{rr}	Reverse recovery time	$I_F = 40\text{ A}$, $V_R = 400\text{ V}$, $V_{GE} = 15\text{ V}$, $di/dt = 1000\text{ A}/\mu\text{s}$ (see Figure 33. Test circuit for inductive load switching)	-	41	-	ns
Q_{rr}	Reverse recovery charge		-	440	-	nC
I_{rrm}	Reverse recovery current		-	21.6	-	A
dI_{rr}/dt	Peak rate of fall of reverse recovery current during t_b		-	1363	-	A/ μ s
E_{rr}	Reverse recovery energy		-	151	-	μ J
t_{rr}	Reverse recovery time	$I_F = 40\text{ A}$, $V_R = 400\text{ V}$, $V_{GE} = 15\text{ V}$, $di/dt = 1000\text{ A}/\mu\text{s}$, $T_J = 175\text{ }^\circ\text{C}$ (see Figure 33. Test circuit for inductive load switching)	-	109	-	ns
Q_{rr}	Reverse recovery charge		-	2400	-	nC
I_{rrm}	Reverse recovery current		-	44.4	-	A
dI_{rr}/dt	Peak rate of fall of reverse recovery current during t_b		-	670	-	A/ μ s
E_{rr}	Reverse recovery energy		-	718	-	μ J

2.1 Electrical characteristics (curves)
Figure 1. Power dissipation vs case temperature for TO-247 and TO-3P

Figure 2. Collector current vs case temperature for TO-247 and TO-3P

Figure 3. Power dissipation vs case temperature for TO-3PF

Figure 4. Collector current vs case temperature for TO-3PF

Figure 5. Output characteristics ($T_J = 25\text{ }^\circ\text{C}$)

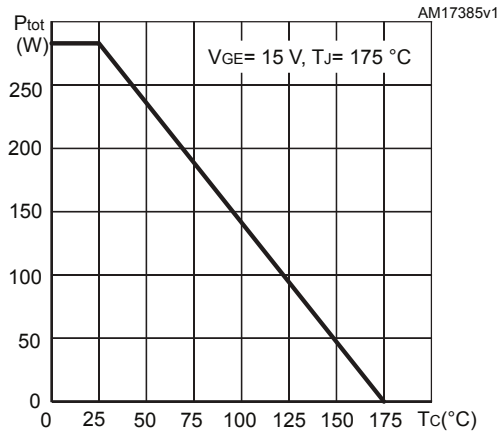
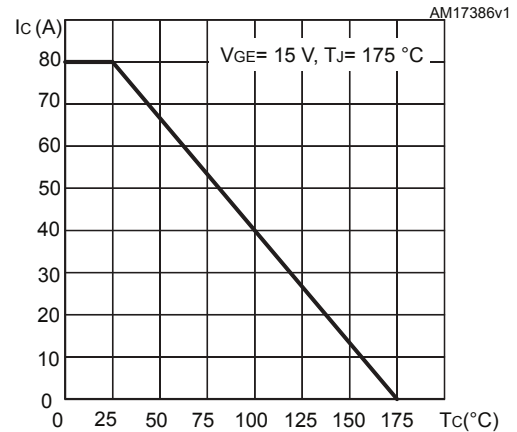
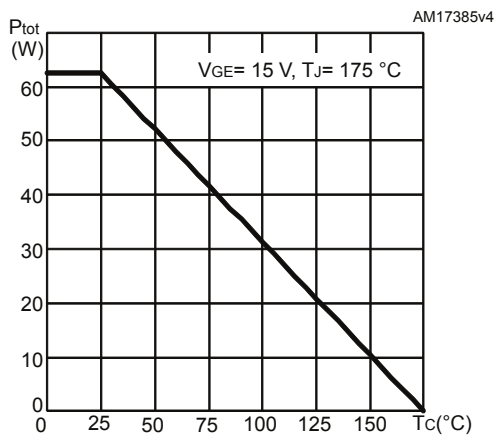
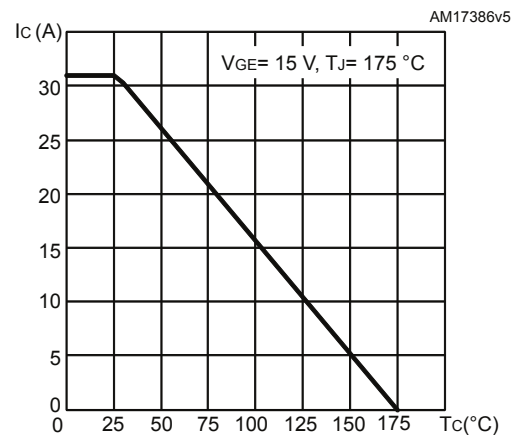
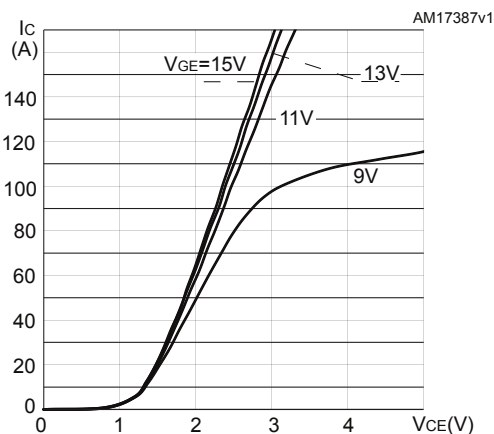
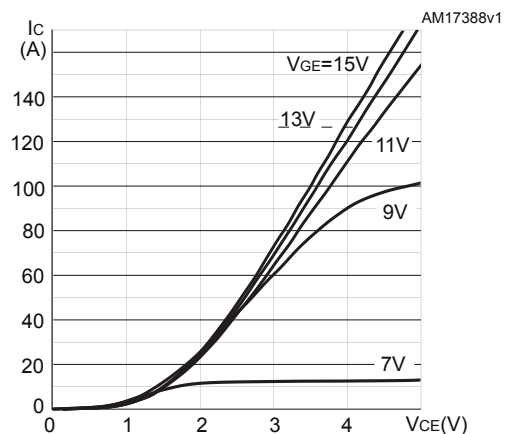
Figure 6. Output characteristics ($T_J = 175\text{ }^\circ\text{C}$)

Figure 7. $V_{CE(sat)}$ vs junction temperature

Figure 8. $V_{CE(sat)}$ vs collector current

Figure 9. Collector current vs switching frequency for TO-247 and TO-3P

Figure 10. Collector current vs switching frequency for TO-3PF

Figure 11. Forward bias safe operating area for TO-247 and TO-3P

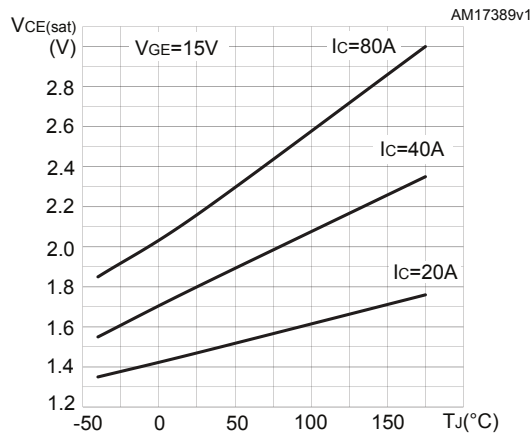
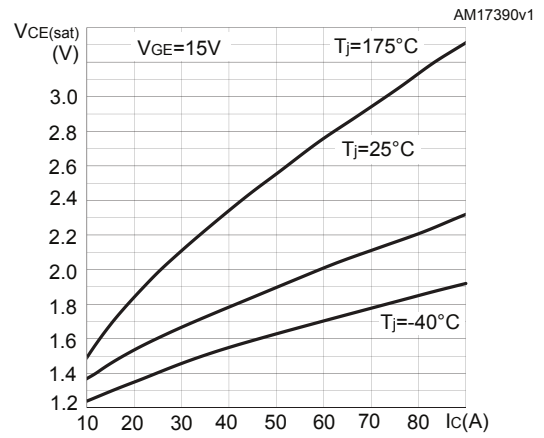
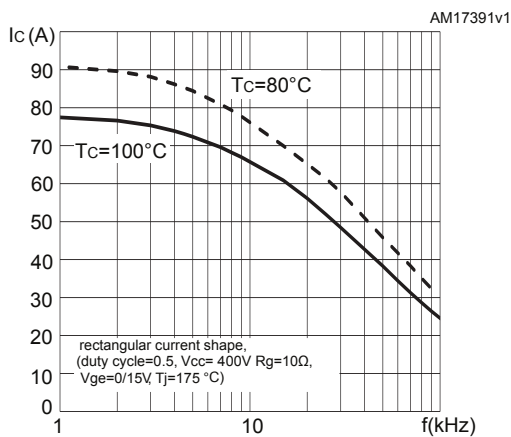
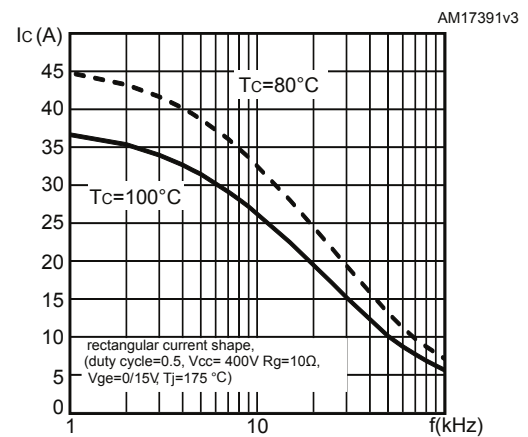
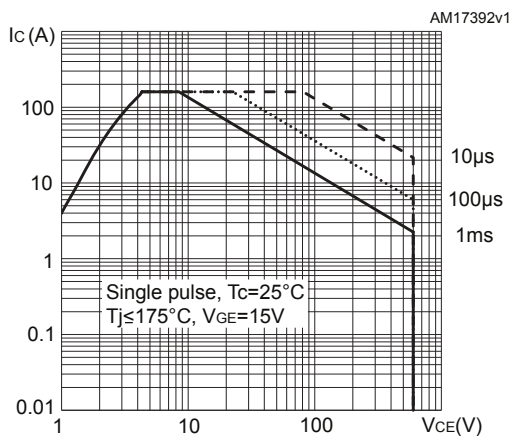
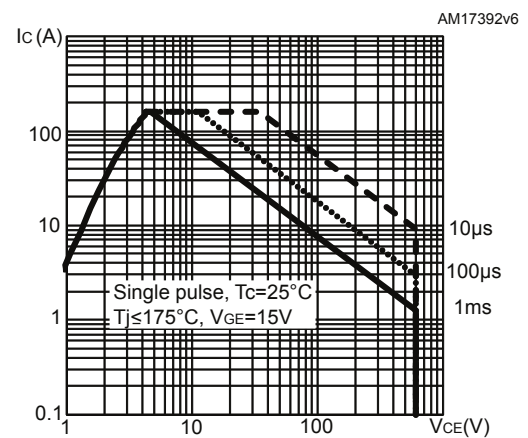
Figure 12. Forward bias safe operating area for TO-3PF

Figure 13. Transfer characteristics

Figure 14. Diode V_F vs forward current

Figure 15. Normalized $V_{GE(th)}$ vs junction temperature

Figure 16. Normalized $V_{(BR)CES}$ vs junction temperature

Figure 17. Capacitance variations

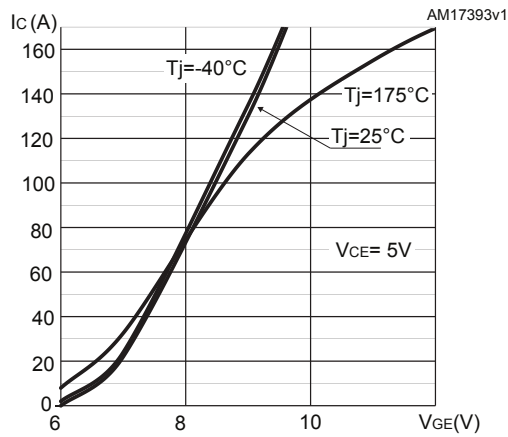
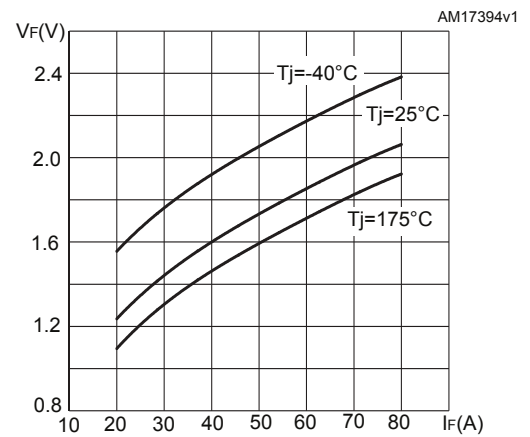
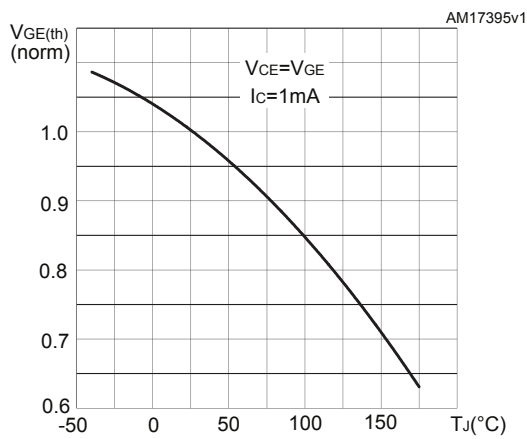
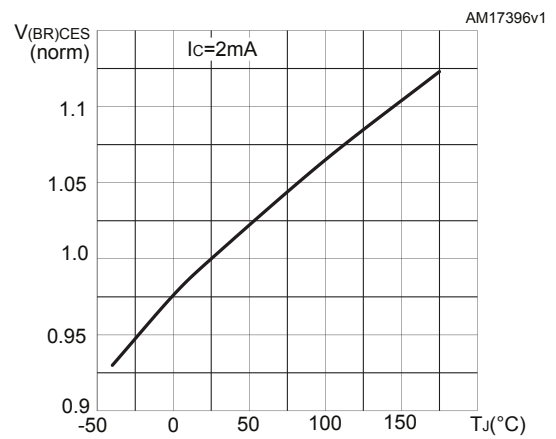
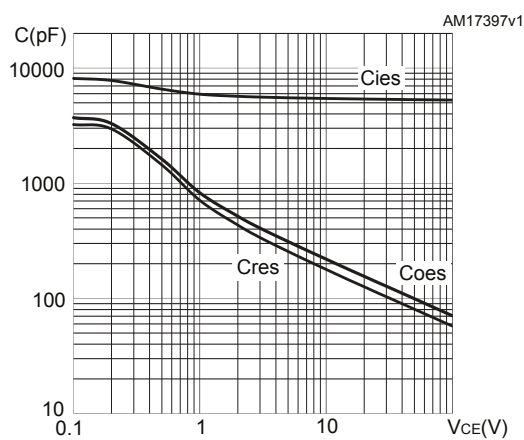
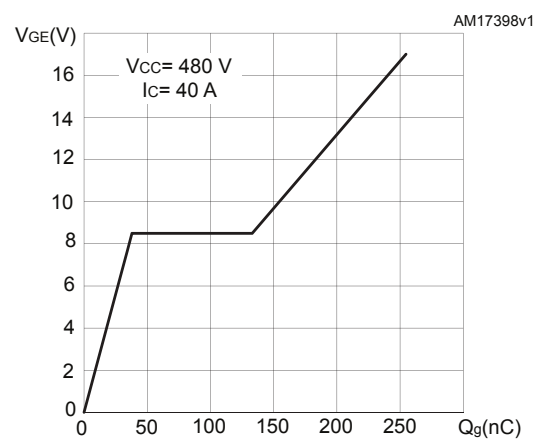
Figure 18. Gate charge vs gate-emitter voltage

Figure 19. Switching energy vs collector current

Figure 20. Switching energy vs gate resistance

Figure 21. Switching energy vs junction temperature

Figure 22. Switching energy vs collector emitter voltage

Figure 23. Switching times vs collector current

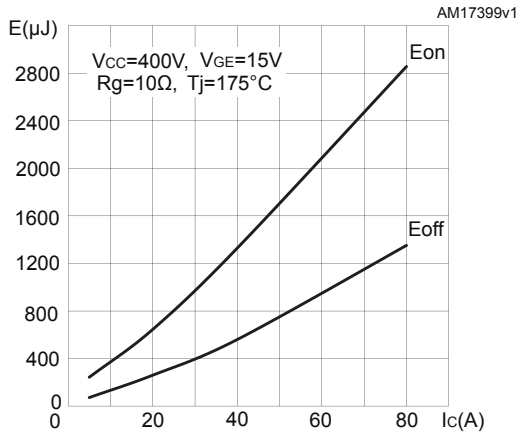
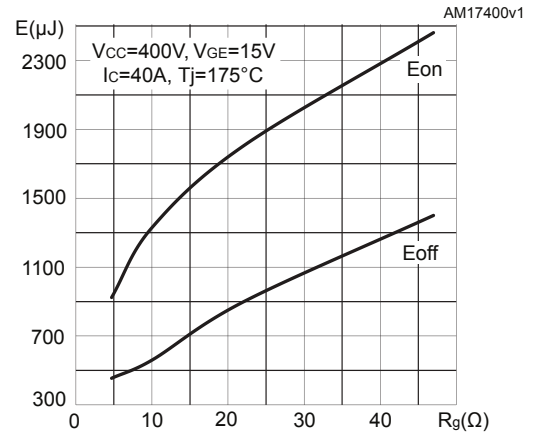
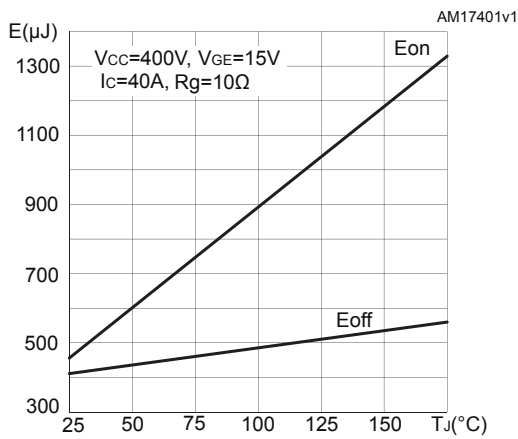
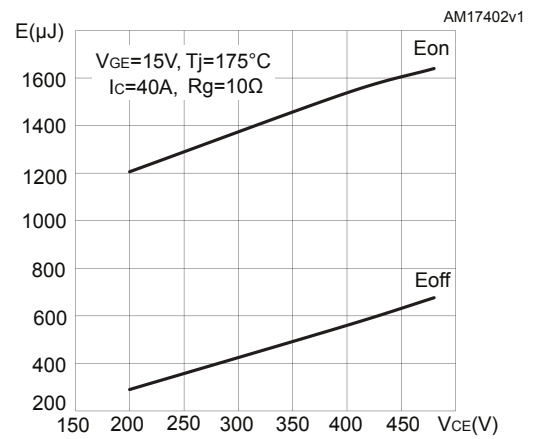
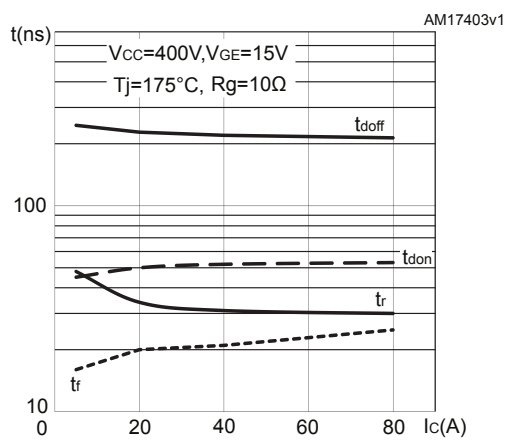
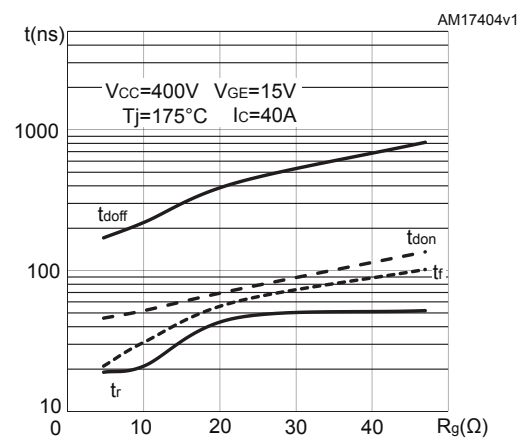
Figure 24. Switching times vs gate resistance

Figure 25. Reverse recovery current vs diode current slope

Figure 26. Reverse recovery time vs diode current slope

Figure 27. Reverse recovery charge vs diode current slope

Figure 28. Reverse recovery energy vs diode current slope

Figure 29. Thermal impedance for IGBT in TO-247 and TO-3P

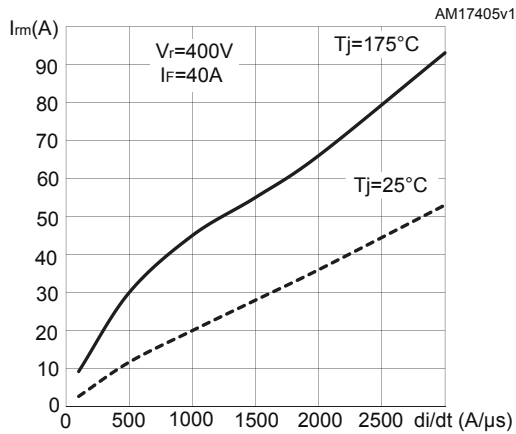
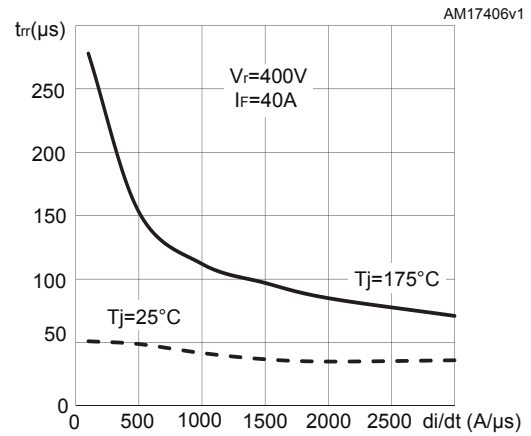
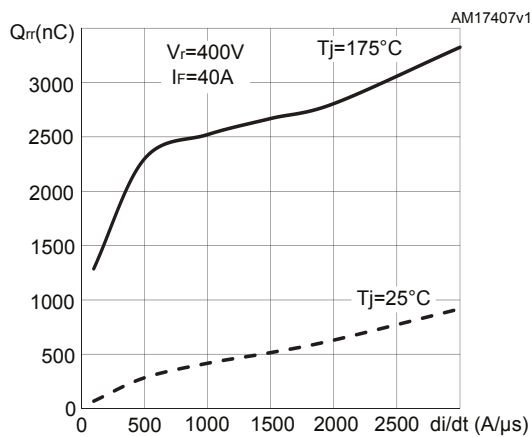
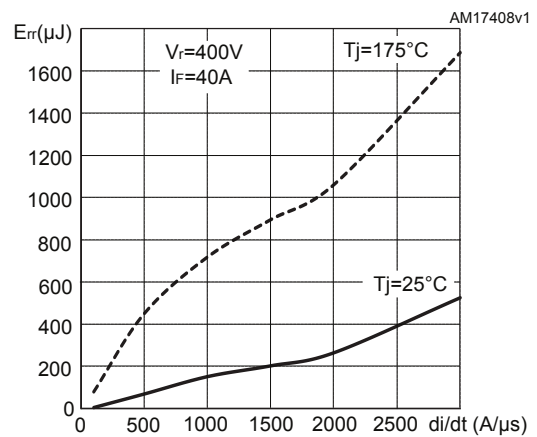
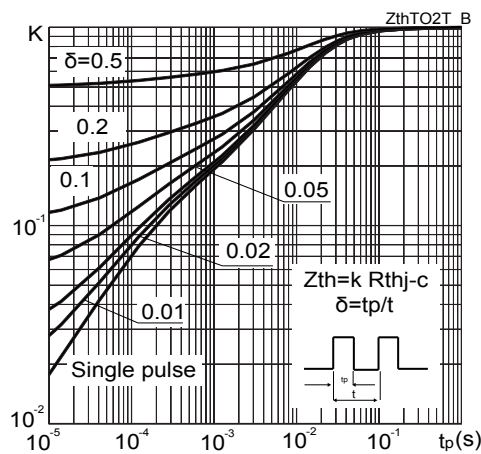
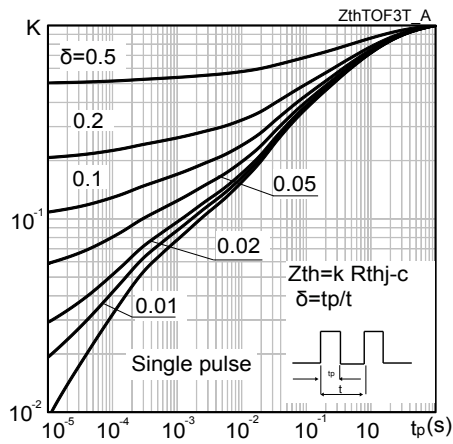
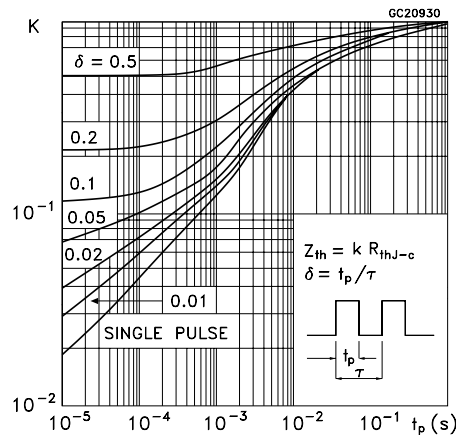
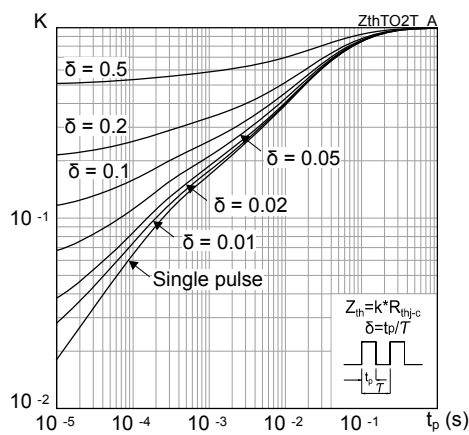
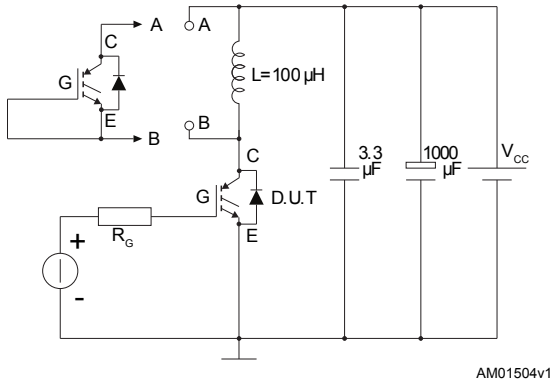
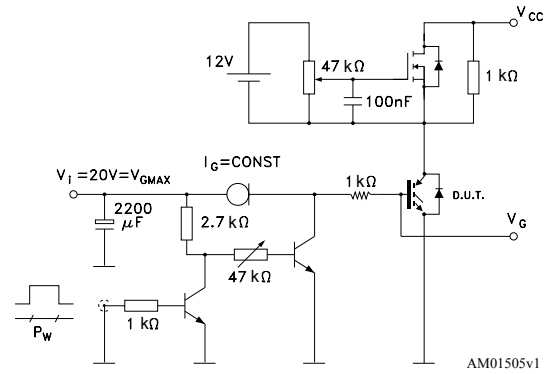
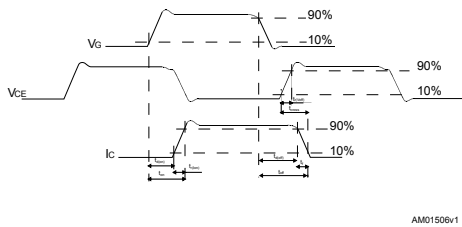
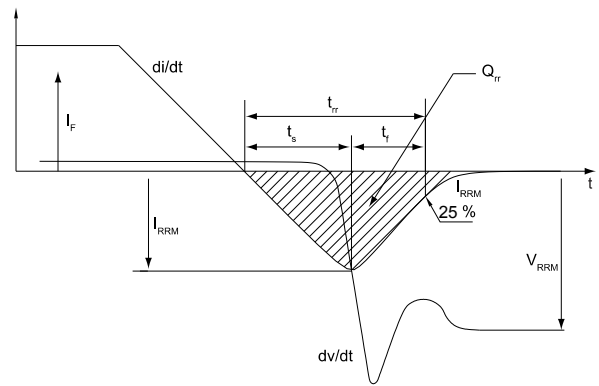
Figure 30. Thermal impedance for IGBT in TO-3PF

Figure 31. Thermal impedance for diode in TO-247 and TO-3P

Figure 32. Thermal impedance for diode in TO-3PF

3 Test circuits

Figure 33. Test circuit for inductive load switching

Figure 34. Gate charge test circuit

Figure 35. Switching waveform

Figure 36. Diode reverse recovery waveform

4 Package information

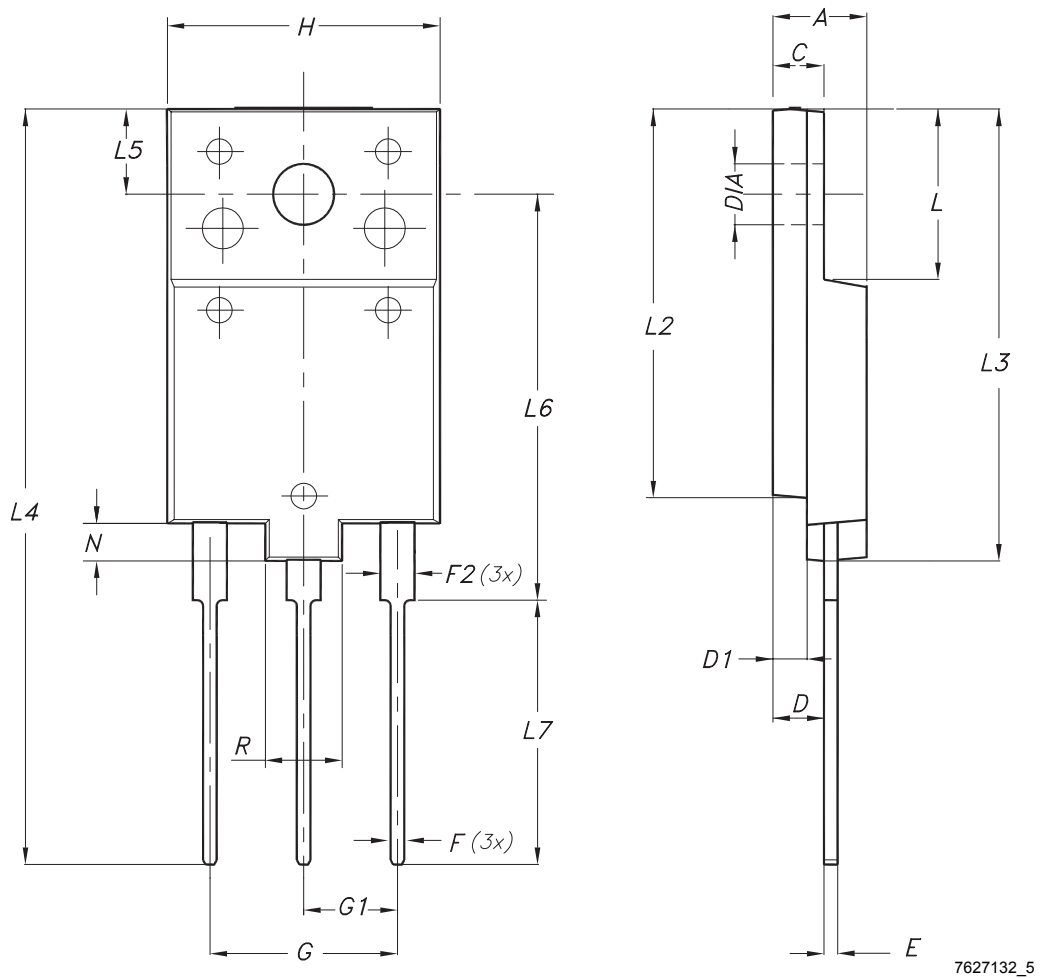
In order to meet environmental requirements, ST offers these devices in different grades of **ECOPACK** packages, depending on their level of environmental compliance. ECOPACK specifications, grade definitions and product status are available at: www.st.com. ECOPACK is an ST trademark.

4.1 TO-3PF package information

Figure 37. TO-3PF package outline



7627132_5

Table 7. TO-3PF mechanical data

Dim.	mm		
	Min.	Typ.	Max.
A	5.30		5.70
C	2.80		3.20
D	3.10		3.50
D1	1.80		2.20
E	0.80		1.10
F	0.65		0.95
F2	1.80		2.20
G	10.30		11.50
G1		5.45	
H	15.30		15.70
L	9.80	10	10.20
L2	22.80		23.20
L3	26.30		26.70
L4	43.20		44.40
L5	4.30		4.70
L6	24.30		24.70
L7	14.60		15
N	1.80		2.20
R	3.80		4.20
Dia	3.40		3.80

4.2 TO-247 package information

Figure 38. TO-247 package outline

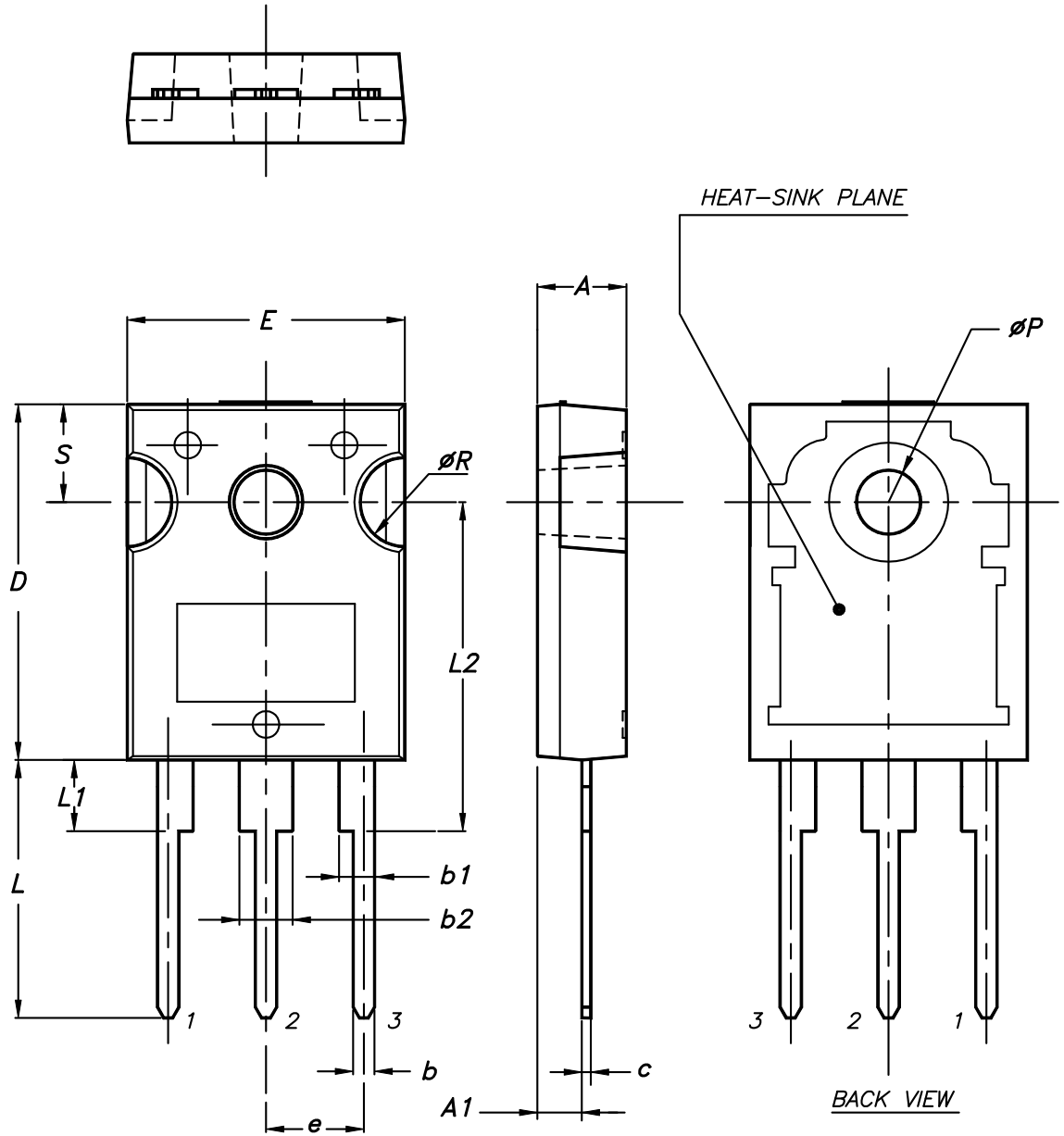

0075325_9

Table 8. TO-247 package mechanical data

Dim.	mm		
	Min.	Typ.	Max.
A	4.85		5.15
A1	2.20		2.60
b	1.0		1.40
b1	2.0		2.40
b2	3.0		3.40
c	0.40		0.80
D	19.85		20.15
E	15.45		15.75
e	5.30	5.45	5.60
L	14.20		14.80
L1	3.70		4.30
L2		18.50	
ØP	3.55		3.65
ØR	4.50		5.50
S	5.30	5.50	5.70

4.3 TO-3P package information

Figure 39. TO-3P package outline

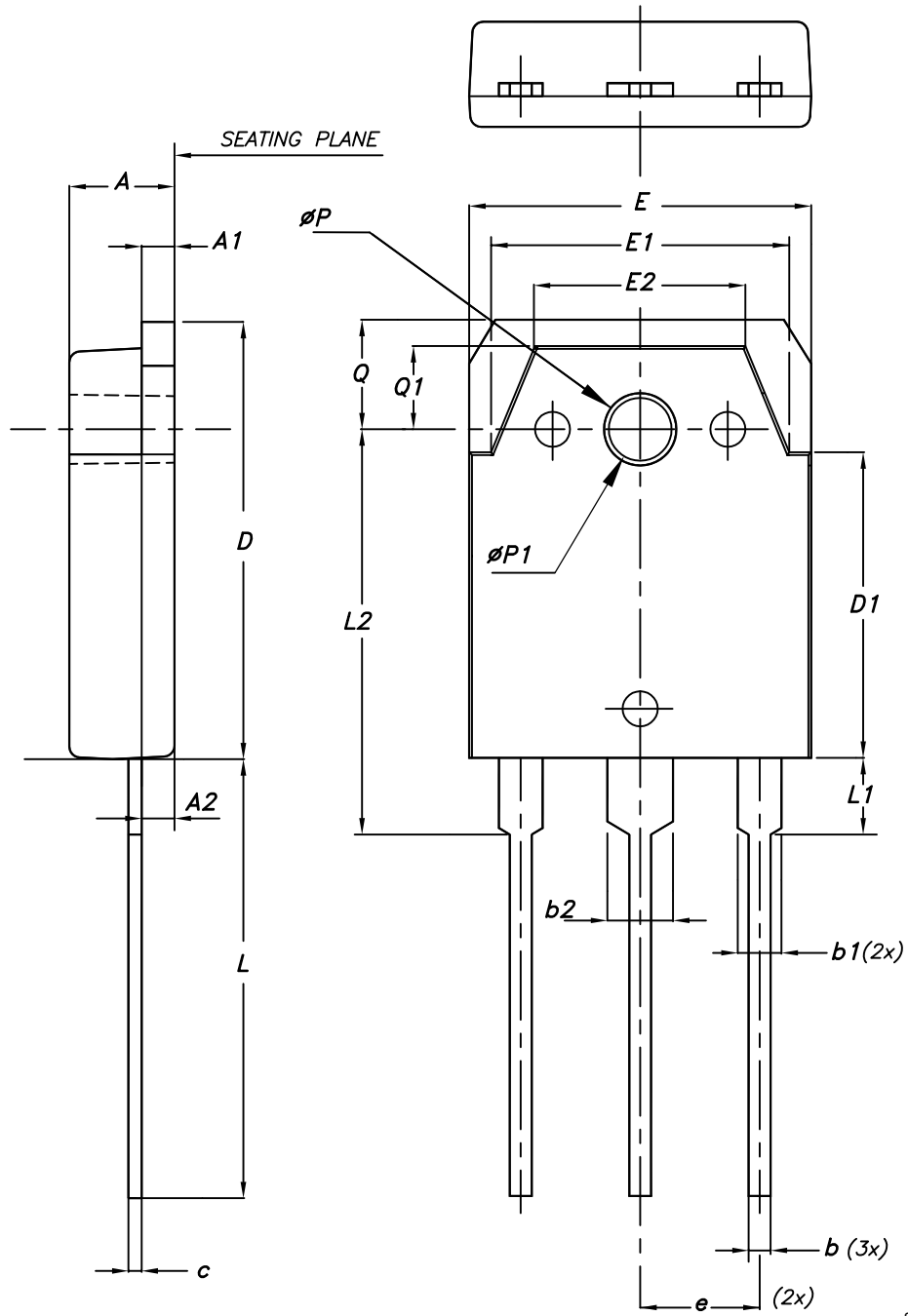

8045950_3

Table 9. TO-3P package mechanical data

Dim.	mm		
	Min.	Typ.	Max.
A	4.60	4.80	5.00
A1	1.45	1.50	1.65
A2	1.20	1.40	1.60
b	0.80	1.00	1.20
b1	1.80	2.00	2.20
b2	2.80	3.00	3.20
c	0.55	0.60	0.75
D	19.70	19.90	20.10
D1	13.70	13.90	14.10
E	15.40	15.60	15.80
E1	13.40	13.60	13.80
E2	9.40	9.60	9.90
e	5.15	5.45	5.75
L	19.80	20.00	20.20
L1	3.30	3.50	3.70
L2	18.20	18.40	18.60
ØP	3.30	3.40	3.50
ØP1	3.10	3.20	3.30
Q	4.80	5.00	5.20
Q1	3.60	3.80	4.00

5 Ordering information

Table 10. Order codes

Order code	Marking	Package	Packing
STGFW40V60DF	G40V60DF	TO-3PF	Tube
STGW40V60DF	GW40V60DF	TO-247	
STGWT40V60DF	GWT40V60DF	TO-3P	

Revision history

Table 11. Document revision history

Date	Revision	Changes
20-Mar-2013	1	Initial release
17-Apr-2013	2	Document status promoted from preliminary data to production data. Added: <i>Section 2.1: Electrical characteristics (curves)</i>
04-Jun-2013	3	Added minimum and maximum values for $V_{GE(th)}$ in <i>Table 4: Static characteristics</i> .
11-Sep-2013	4	Updated V_F value in <i>Table 4: Static characteristics</i> .
08-Oct-2013	5	Updated title, features and description in cover page.
10-Jan-2014	6	Updated <i>Figure 8: $V_{CE(sat)}$ vs. junction temperature</i> , <i>Figure 15: Diode V_F vs. forward current</i> and <i>Figure 16: Normalized $V_{GE(th)}$ vs junction temperature</i> .
03-Mar-2014	7	Updated test conditions in <i>Table 7: Diode switching characteristics (inductive load)</i> .
23-Apr-2014	8	Added new device in TO-3PF. Updated <i>Table 1: Device summary</i> , <i>Table 2: Absolute maximum ratings</i> , <i>Table 3: Thermal data</i> and <i>Section 4: Package mechanical data</i> . Added <i>Figure 4: Power dissipation vs. case temperature for TO-3PF</i> , <i>Figure 5: Collector current vs. case temperature for TO-3PF</i> , <i>Figure 11: Collector current vs. switching frequency for TO-3PF</i> and <i>Figure 12: Forward bias safe operating area for TO-247 and TO-3P</i> . Minor text changes.
27-Oct-2017	9	Updated <i>Table 3: "Thermal data"</i> . Added <i>Figure 33: "Thermal impedance for diode in TO-3PF"</i> . Updated <i>Section 4: "Package information"</i> . Minor text changes
06-Mar-2020	10	Updated Section 5 Ordering information . Minor text changes.

Contents

1	Electrical ratings	2
2	Electrical characteristics	3
2.1	Electrical characteristics (curves)	5
3	Test circuits	11
4	Package information	12
4.1	TO-3PF package information	12
4.2	TO-247 package information	14
4.3	TO-3P package information	16
5	Ordering information	18
	Revision history	19