

## Trench gate field-stop, 650 V, 30 A, high-speed HB2 series IGBT in a TO-247 long leads package

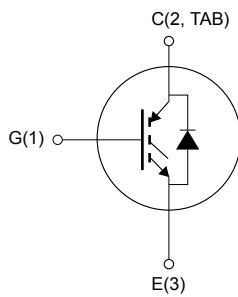

TO-247 long leads



NG1E3C2T



### Product status link

[STGWA30HP65FB2](#)

### Product summary

<b>Order code</b>	STGWA30HP65FB2
<b>Marking</b>	G30HP65FB2
<b>Package</b>	TO-247 long leads
<b>Packing</b>	Tube

### Features

- Maximum junction temperature :  $T_J = 175\text{ °C}$
- Low  $V_{CE(sat)} = 1.65\text{ V (typ.) @ } I_C = 30\text{ A}$
- Co-packaged protection diode
- Minimized tail current
- Tight parameter distribution
- Low thermal resistance
- Positive  $V_{CE(sat)}$  temperature coefficient

### Applications

- [Welding](#)
- [Power factor correction](#)

### Description

The newest IGBT 650 V HB2 series represents an evolution of the advanced proprietary trench gate field-stop structure. The performance of the HB2 series is optimized in terms of conduction, thanks to a better  $V_{CE(sat)}$  behavior at low current values, as well as in terms of reduced switching energy. A diode used for protection purposes only is co-packaged in antiparallel with the IGBT. The result is a product specifically designed to maximize efficiency for a wide range of fast applications.

# 1 Electrical ratings

**Table 1. Absolute maximum ratings**

Symbol	Parameter	Value	Unit
$V_{CES}$	Collector-emitter voltage ( $V_{GE} = 0$ V)	650	V
$I_C$	Continuous collector current at $T_C = 25$ °C	50	A
	Continuous collector current at $T_C = 100$ °C	30	A
$I_{CP}^{(1)(2)}$	Pulsed collector current	90	A
$V_{GE}$	Gate-emitter voltage	±20	V
	Transient gate-emitter voltage ( $t_p \leq 10$ μs)	±30	
$I_F$	Continuous forward current at $T_C = 25$ °C	5	A
	Continuous forward current at $T_C = 100$ °C	5	
$I_{FP}^{(1)(2)}$	Pulsed forward current	10	A
$P_{TOT}$	Total power dissipation at $T_C = 25$ °C	167	W
$T_{STG}$	Storage temperature range	-55 to 150	°C
$T_J$	Operating junction temperature range	-55 to 175	°C

1. Pulse width is limited by maximum junction temperature.
2. Defined by design, not subject to production test.

**Table 2. Thermal data**

Symbol	Parameter	Value	Unit
$R_{thJC}$	Thermal resistance junction-case IGBT	0.9	°C/W
	Thermal resistance junction-case diode	5	
$R_{thJA}$	Thermal resistance junction-ambient	50	

## 2 Electrical characteristics

$T_C = 25\text{ °C}$  unless otherwise specified

**Table 3. Static characteristics**

Symbol	Parameter	Test conditions	Min.	Typ.	Max.	Unit
$V_{(BR)CES}$	Collector-emitter breakdown voltage	$V_{GE} = 0\text{ V}, I_C = 1\text{ mA}$	650			V
$V_{CE(sat)}$	Collector-emitter saturation voltage	$V_{GE} = 15\text{ V}, I_C = 30\text{ A}$		1.65	2.1	V
		$V_{GE} = 15\text{ V}, I_C = 30\text{ A}, T_J = 125\text{ °C}$		1.85		
		$V_{GE} = 15\text{ V}, I_C = 30\text{ A}, T_J = 175\text{ °C}$		2.0		
$V_F$	Forward on-voltage	$I_F = 5\text{ A}$		2	2.8	V
		$I_F = 5\text{ A}, T_J = 125\text{ °C}$		1.85		
		$I_F = 5\text{ A}, T_J = 175\text{ °C}$		1.75		
$V_{GE(th)}$	Gate threshold voltage	$V_{CE} = V_{GE}, I_C = 1\text{ mA}$	5	6	7	V
$I_{CES}$	Collector cut-off current	$V_{GE} = 0\text{ V}, V_{CE} = 650\text{ V}$			25	$\mu\text{A}$
$I_{GES}$	Gate-emitter leakage current	$V_{CE} = 0\text{ V}, V_{GE} = \pm 20\text{ V}$			$\pm 250$	nA

**Table 4. Dynamic characteristics**

Symbol	Parameter	Test conditions	Min.	Typ.	Max.	Unit
$C_{ies}$	Input capacitance	$V_{CE} = 25\text{ V}, f = 1\text{ MHz}, V_{GE} = 0\text{ V}$	-	1570	-	$\mu\text{F}$
$C_{oes}$	Output capacitance		-	98	-	
$C_{res}$	Reverse transfer capacitance		-	40	-	
$Q_g$	Total gate charge	$V_{CC} = 520\text{ V}, I_C = 30\text{ A}, V_{GE} = 0\text{ to }15\text{ V}$ (see Figure 27. Gate charge test circuit)	-	90	-	nC
$Q_{ge}$	Gate-emitter charge		-	15.3	-	
$Q_{gc}$	Gate-collector charge		-	41.5	-	

**Table 5. Switching characteristics (inductive load)**

Symbol	Parameter	Test conditions	Min.	Typ.	Max.	Unit
$t_{d(off)}$	Turn-off delay time	$V_{CC} = 400\text{ V}, I_C = 30\text{ A},$	-	71	-	ns
$t_f$	Current fall time	$V_{GE} = 15\text{ V}, R_G = 6.8\ \Omega$	-	41	-	ns
$E_{off}^{(1)}$	Turn-off switching energy	(see Figure 26. Test circuit for inductive load switching)	-	310	-	$\mu\text{J}$
$t_{d(off)}$	Turn-off delay time	$V_{CC} = 400\text{ V}, I_C = 30\text{ A},$	-	79	-	ns
$t_f$	Current fall time	$V_{GE} = 15\text{ V}, R_G = 6.8\ \Omega, T_J = 175\text{ °C}$	-	105	-	ns
$E_{off}^{(1)}$	Turn-off switching energy	(see Figure 26. Test circuit for inductive load switching)	-	643	-	$\mu\text{J}$

1. Including the tail of the collector current.

**Table 6. Diode switching characteristics (inductive load)**

Symbol	Parameter	Test conditions	Min.	Typ.	Max.	Unit
$t_{rr}$	Reverse recovery time	$I_F = 5\text{ A}$ , $V_R = 400\text{ V}$ , $V_{GE} = 15\text{ V}$ , $di/dt = 1000\text{ A}/\mu\text{s}$ (see <a href="#">Figure 29. Diode reverse recovery waveform</a> )	-	140	-	ns
$Q_{rr}$	Reverse recovery charge		-	21	-	nC
$I_{rrm}$	Reverse recovery current		-	6.6	-	A
$di_{rr}/dt$	Peak rate of fall of reverse recovery current during $t_b$		-	430	-	A/ $\mu\text{s}$
$E_{rr}$	Reverse recovery energy		-	1.6	-	$\mu\text{J}$
$t_{rr}$	Reverse recovery time	$I_F = 5\text{ A}$ , $V_R = 400\text{ V}$ , $V_{GE} = 15\text{ V}$ , $di/dt = 1000\text{ A}/\mu\text{s}$ , $T_J = 175\text{ }^\circ\text{C}$ (see <a href="#">Figure 29. Diode reverse recovery waveform</a> )	-	200	-	ns
$Q_{rr}$	Reverse recovery charge		-	47.3	-	nC
$I_{rrm}$	Reverse recovery current		-	9.6	-	A
$di_{rr}/dt$	Peak rate of fall of reverse recovery current during $t_b$		-	428	-	A/ $\mu\text{s}$
$E_{rr}$	Reverse recovery energy		-	3.2	-	$\mu\text{J}$

## 2.1 Electrical characteristics (curves)

**Figure 1. Power dissipation vs case temperature**

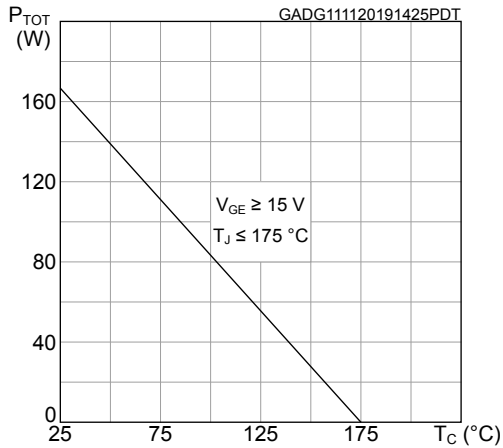

**Figure 2. Collector current vs case temperature**

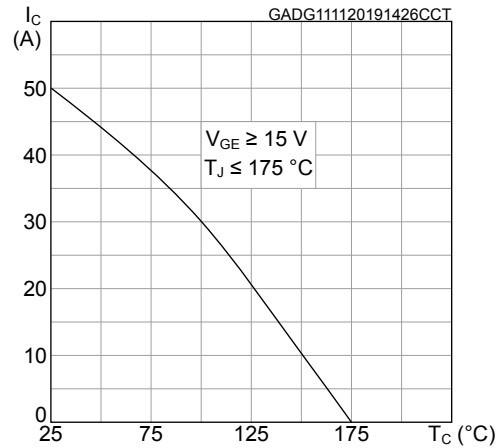

**Figure 3. Output characteristics ( $T_J = 25\text{ °C}$ )**

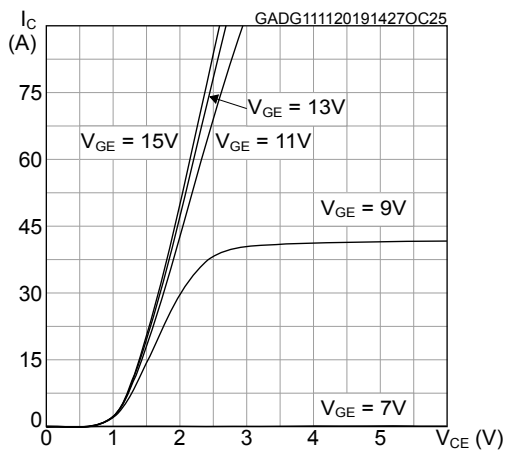

**Figure 4. Output characteristics ( $T_J = 175\text{ °C}$ )**

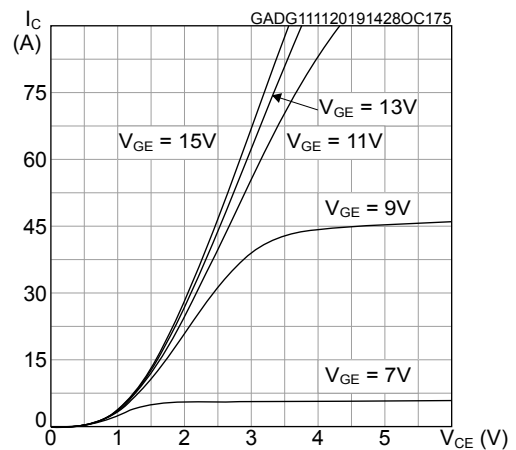

**Figure 5.  $V_{CE(sat)}$  vs junction temperature**

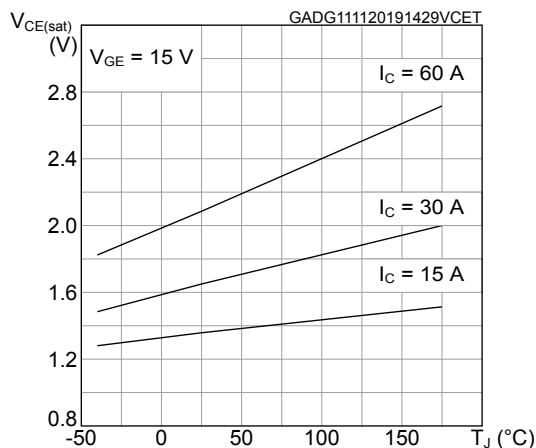

**Figure 6.  $V_{CE(sat)}$  vs collector current**

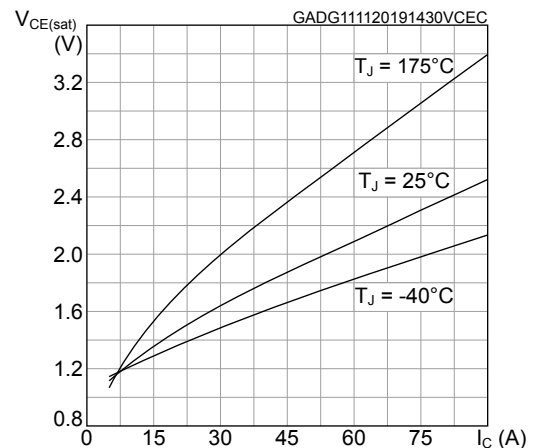

**Figure 7. Forward bias safe operating area**

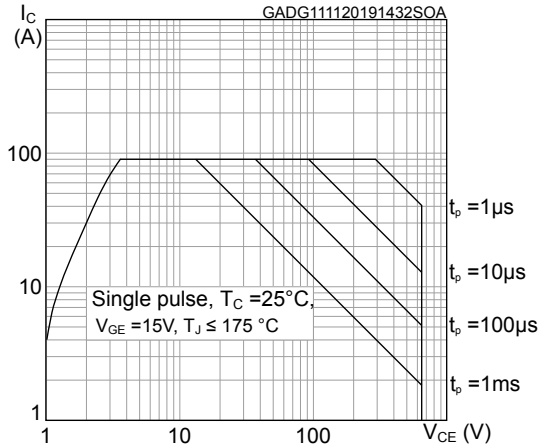

**Figure 8. Transfer characteristics**

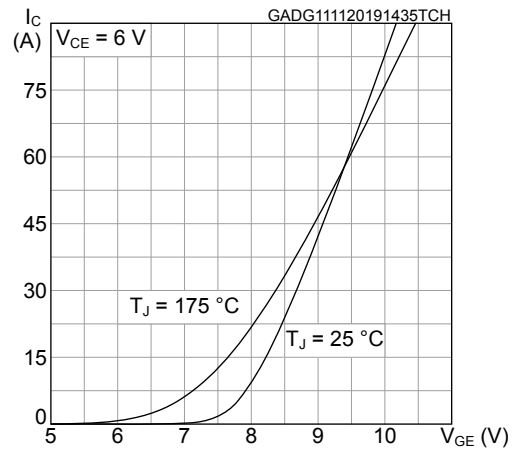

**Figure 9. Diode V\_F vs forward current**

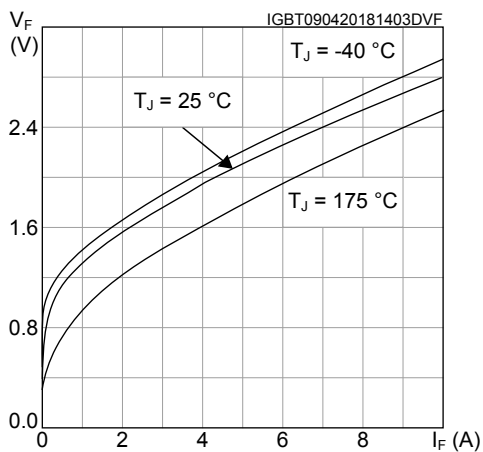

**Figure 10. Normalized V\_GE(th) vs junction temperature**

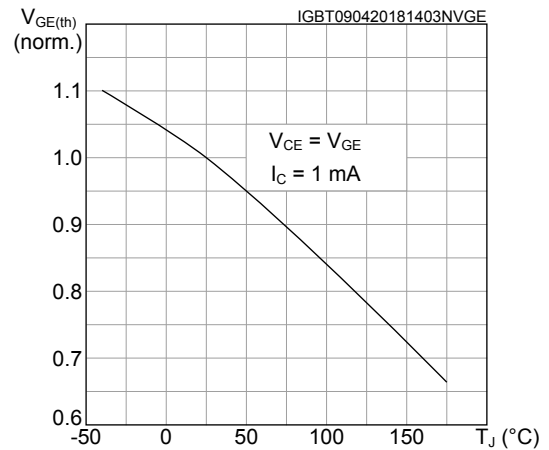

**Figure 11. Normalized V\_(BR)CES vs junction temperature**

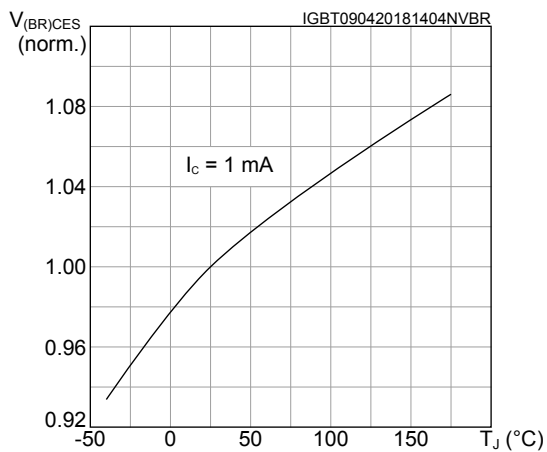

**Figure 12. Capacitance variations**

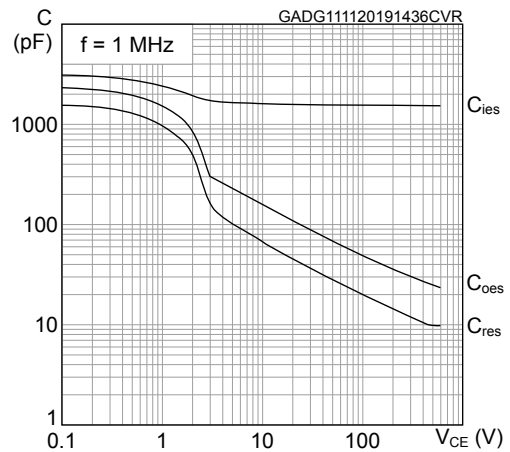

**Figure 13. Gate charge vs gate-emitter voltage**

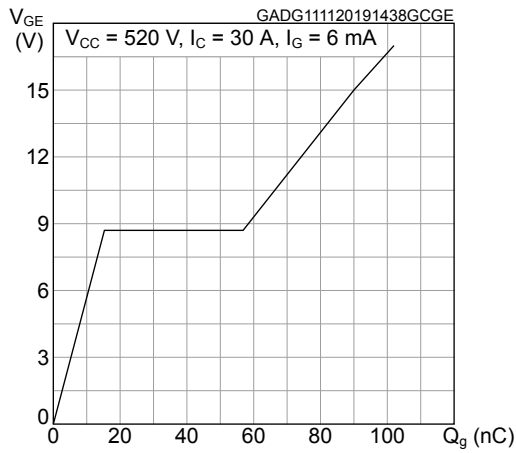

**Figure 14. Switching energy vs collector current**

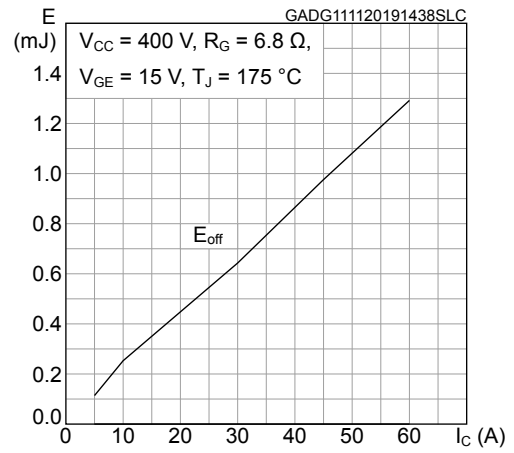

**Figure 15. Switching energy vs temperature**

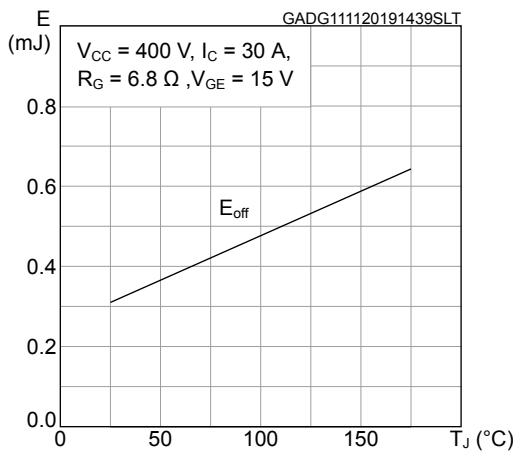

**Figure 16. Switching energy vs collector emitter voltage**

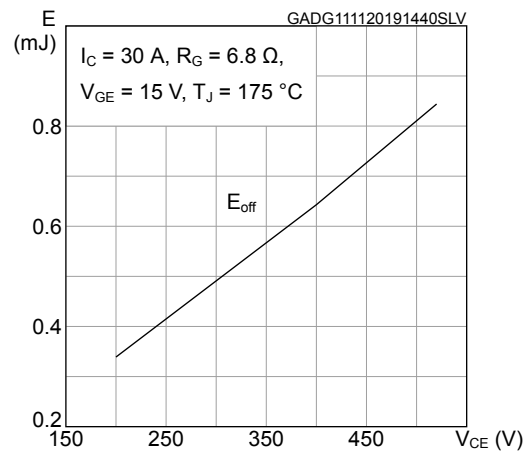

**Figure 17. Switching energy vs gate resistance**

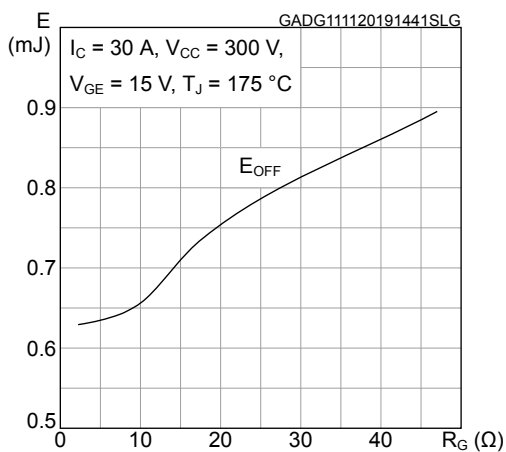

**Figure 18. Switching times vs collector current**

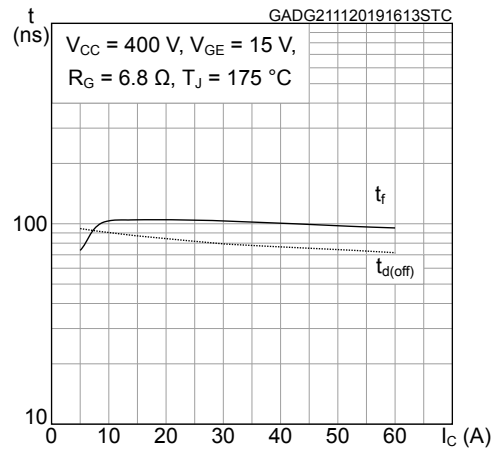

**Figure 19. Switching times vs gate resistance**

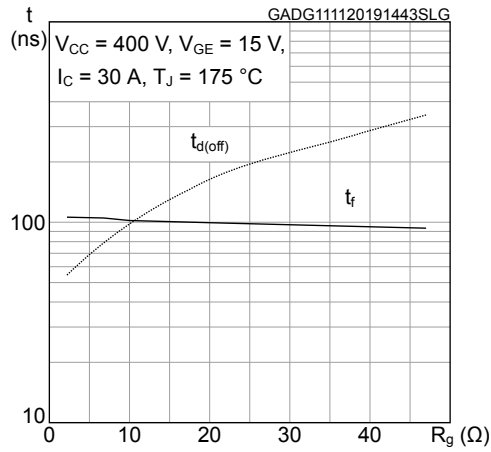

**Figure 20. Reverse recovery current vs diode current slope**

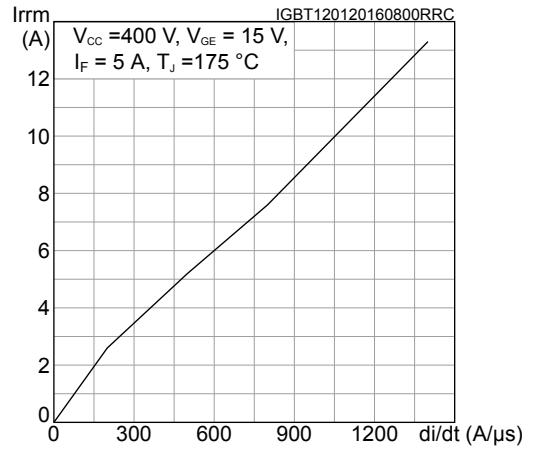

**Figure 21. Reverse recovery time vs diode current slope**

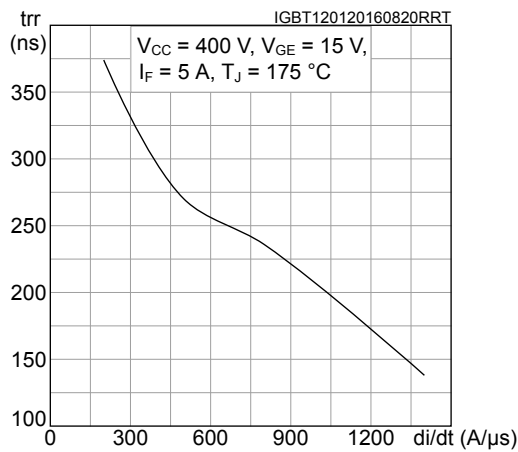

**Figure 22. Reverse recovery charge vs diode current slope**

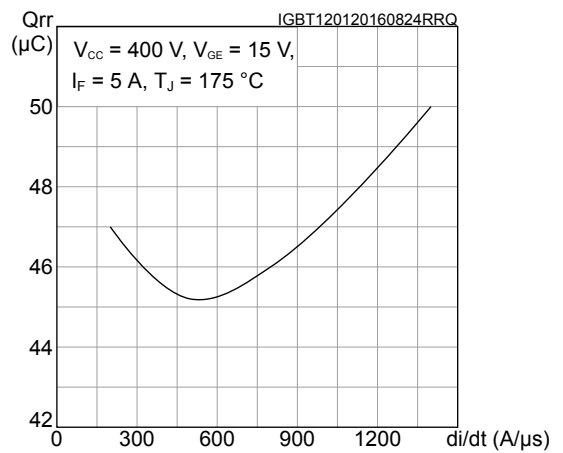

**Figure 23. Reverse recovery energy vs diode current slope**

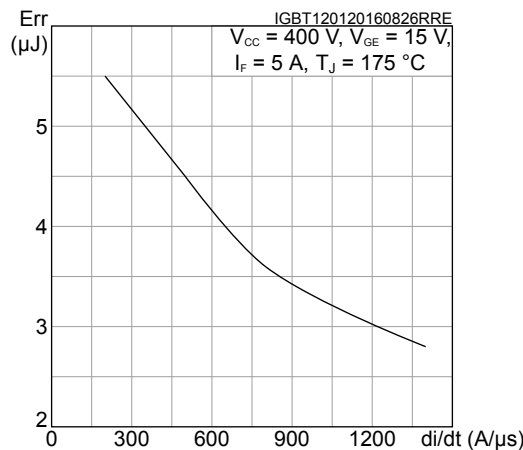



Figure 24. Thermal impedance for IGBT

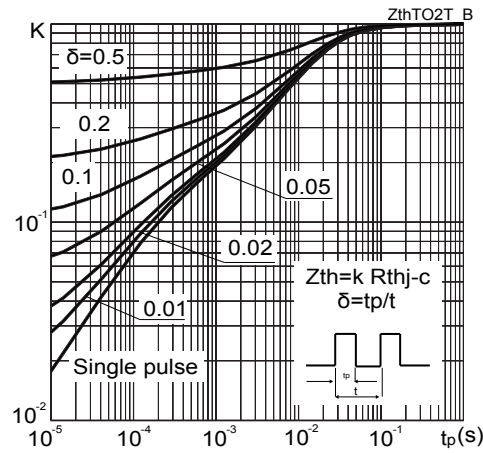
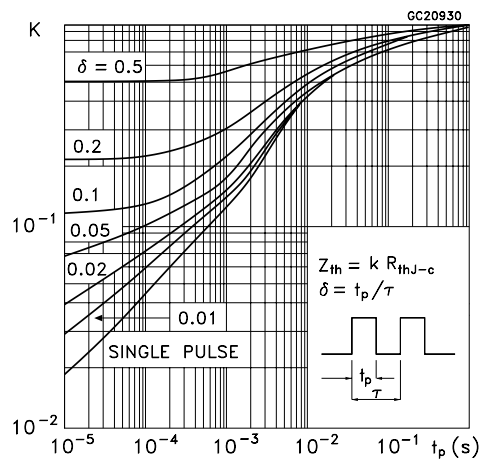
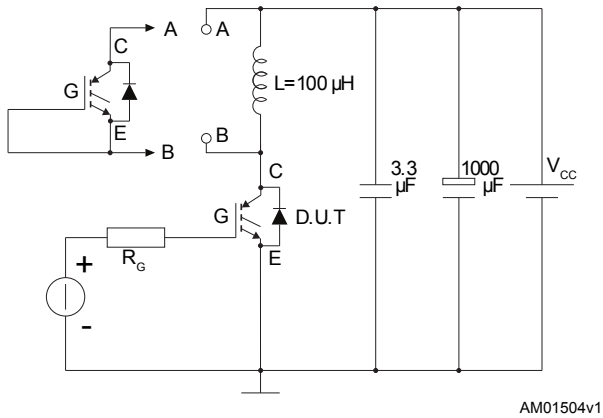
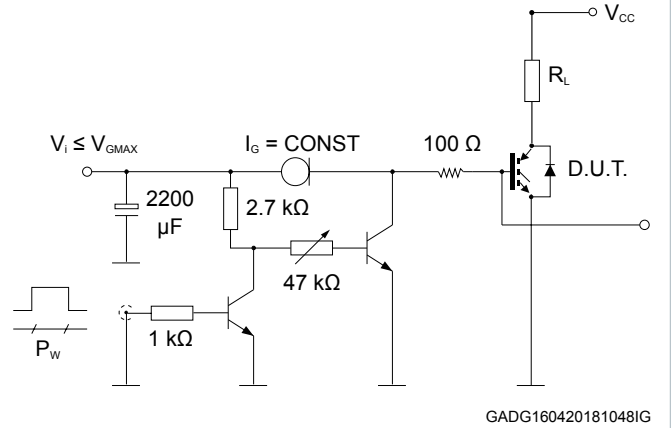
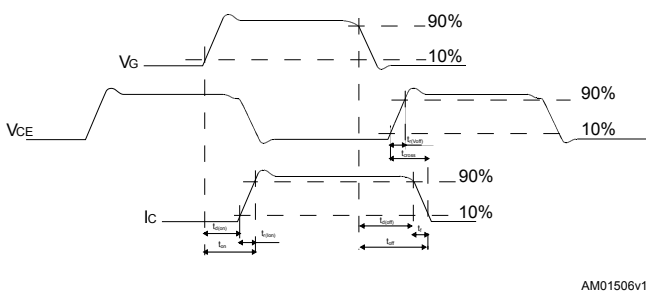
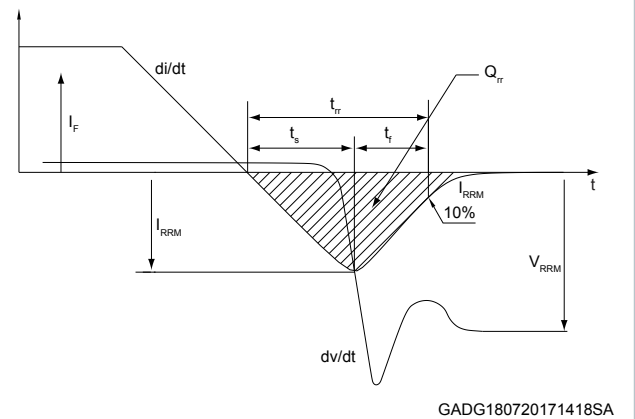

Figure 25. Thermal impedance for diode



### 3 Test circuits

**Figure 26. Test circuit for inductive load switching**

**Figure 27. Gate charge test circuit**

**Figure 28. Switching waveform**

**Figure 29. Diode reverse recovery waveform**

## 4 Package information

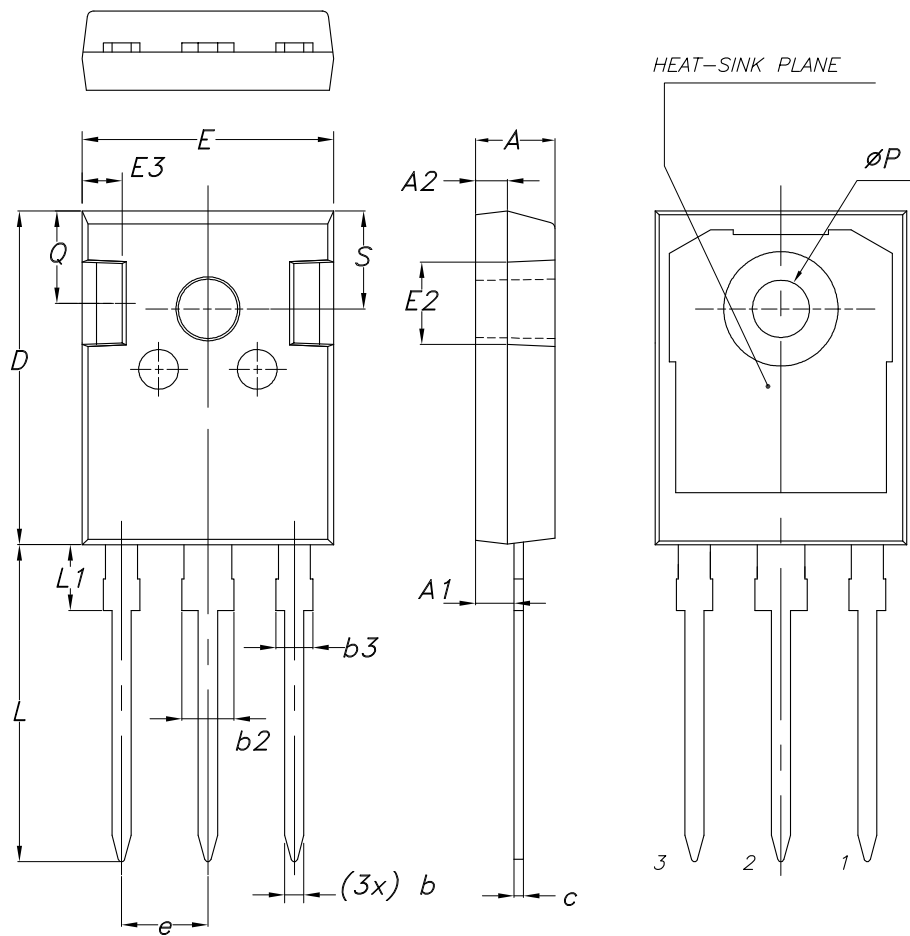
In order to meet environmental requirements, ST offers these devices in different grades of **ECOPACK** packages, depending on their level of environmental compliance. ECOPACK specifications, grade definitions and product status are available at: [www.st.com](http://www.st.com). ECOPACK is an ST trademark.

### 4.1 TO-247 long leads package information

Figure 30. TO-247 long leads package outline



8463846\_2\_F

**Table 7. TO-247 long leads package mechanical data**

Dim.	mm		
	Min.	Typ.	Max.
A	4.90	5.00	5.10
A1	2.31	2.41	2.51
A2	1.90	2.00	2.10
b	1.16		1.26
b2			3.25
b3			2.25
c	0.59		0.66
D	20.90	21.00	21.10
E	15.70	15.80	15.90
E2	4.90	5.00	5.10
E3	2.40	2.50	2.60
e	5.34	5.44	5.54
L	19.80	19.92	20.10
L1			4.30
P	3.50	3.60	3.70
Q	5.60		6.00
S	6.05	6.15	6.25

## Revision history

**Table 8. Document revision history**

Date	Version	Changes
05-Nov-2019	1	First release.

---

## Contents

<b>1</b>	<b>Electrical ratings</b> .....	<b>2</b>
<b>2</b>	<b>Electrical characteristics</b> .....	<b>3</b>
<b>2.1</b>	<b>Electrical characteristics (curves)</b> .....	<b>5</b>
<b>3</b>	<b>Test circuits</b> .....	<b>10</b>
<b>4</b>	<b>Package information</b> .....	<b>11</b>
<b>4.1</b>	<b>TO-247 long leads package information</b> .....	<b>11</b>
	<b>Revision history</b> .....	<b>13</b>