

Trench gate field-stop 650 V, 60 A high speed HB series IGBT

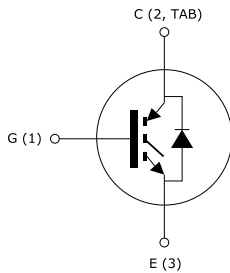
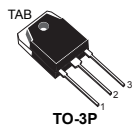
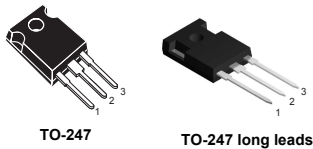

Product status link

[STGW60H65DFB](#)

[STGWT60H65DFB](#)

[STGWA60H65DFB](#)

Features

- Maximum junction temperature: $T_J = 175\text{ }^\circ\text{C}$
- High speed switching series
- Minimized tail current
- Low saturation voltage: $V_{CE(sat)} = 1.6\text{ V (typ.) @ } I_C = 60\text{ A}$
- Tight parameter distribution
- Safe paralleling
- Positive $V_{CE(sat)}$ temperature coefficient
- Low thermal resistance
- Very fast soft recovery antiparallel diode

Applications

- Photovoltaic inverters
- High-frequency converters

Description

These devices are IGBTs developed using an advanced proprietary trench gate field-stop structure. These devices are part of the new HB series of IGBTs, which represent an optimum compromise between conduction and switching loss to maximize the efficiency of any frequency converter. Furthermore, the slightly positive $V_{CE(sat)}$ temperature coefficient and very tight parameter distribution result in safer paralleling operation.

1 Electrical ratings

Table 1. Absolute maximum ratings

Symbol	Parameter	Value	Unit
V_{CES}	Collector-emitter voltage ($V_{GE} = 0$ V)	650	V
I_C	Continuous collector current at $T_C = 25$ °C	80 ⁽¹⁾	A
	Continuous collector current at $T_C = 100$ °C	60	A
I_{CP} ⁽²⁾⁽³⁾	Pulsed collector current	240	A
V_{GE}	Gate-emitter voltage	±20	V
	Transient gate-emitter voltage ($t_p \leq 10$ μs)	±30	V
I_F	Continuous forward current at $T_C = 25$ °C	80 ⁽¹⁾	A
	Continuous forward current at $T_C = 100$ °C	60	A
I_{FP} ⁽²⁾⁽³⁾	Pulsed forward current	240	A
P_{TOT}	Total power dissipation at $T_C = 25$ °C	375	W
T_{STG}	Storage temperature range	-55 to 150	°C
T_J	Operating junction temperature range	-55 to 175	°C

1. Current level is limited by bond wires.
2. Pulse width is limited by maximum junction temperature.
3. Defined by design, not subject to production test.

Table 2. Thermal data

Symbol	Parameter	Value	Unit
R_{thJC}	Thermal resistance junction-case IGBT	0.4	°C/W
R_{thJC}	Thermal resistance junction-case diode	1.14	°C/W
R_{thJA}	Thermal resistance junction-ambient	50	°C/W

2 Electrical characteristics

$T_J = 25\text{ °C}$ unless otherwise specified

Table 3. Static characteristics

Symbol	Parameter	Test conditions	Min.	Typ.	Max.	Unit
$V_{(BR)CES}$	Collector-emitter breakdown voltage	$V_{GE} = 0\text{ V}, I_C = 2\text{ mA}$	650			V
$V_{CE(sat)}$	Collector-emitter saturation voltage	$V_{GE} = 15\text{ V}, I_C = 60\text{ A}$		1.60	2	V
		$V_{GE} = 15\text{ V}, I_C = 60\text{ A}, T_J = 125\text{ °C}$		1.75		
		$V_{GE} = 15\text{ V}, I_C = 60\text{ A}, T_J = 175\text{ °C}$		1.85		
V_F	Forward on-voltage	$I_F = 60\text{ A}$		2	2.6	V
		$I_F = 60\text{ A}, T_J = 125\text{ °C}$		1.7		
		$I_F = 60\text{ A}, T_J = 175\text{ °C}$		1.6		
$V_{GE(th)}$	Gate threshold voltage	$V_{CE} = V_{GE}, I_C = 1\text{ mA}$	5	6	7	V
I_{CES}	Collector cut-off current	$V_{GE} = 0\text{ V}, V_{CE} = 650\text{ V}$			25	μA
I_{GES}	Gate-emitter leakage current	$V_{CE} = 0\text{ V}, V_{GE} = \pm 20\text{ V}$			± 250	nA

Table 4. Dynamic characteristics

Symbol	Parameter	Test conditions	Min.	Typ.	Max.	Unit
C_{ies}	Input capacitance	$V_{CE} = 25\text{ V}, f = 1\text{ MHz}, V_{GE} = 0\text{ V}$	-	7792	-	pF
C_{oes}	Output capacitance		-	262	-	pF
C_{res}	Reverse transfer capacitance		-	158	-	pF
Q_g	Total gate charge	$V_{CC} = 520\text{ V}, I_C = 60\text{ A}, V_{GE} = 0\text{ to }15\text{ V}$ (see Figure 28. Gate charge test circuit)	-	306	-	nC
Q_{ge}	Gate-emitter charge		-	126	-	nC
Q_{gc}	Gate-collector charge		-	58	-	nC

Table 5. IGBT switching characteristics (inductive load)

Symbol	Parameter	Test conditions	Min.	Typ.	Max.	Unit
$t_{d(on)}$	Turn-on delay time	$V_{CE} = 400\text{ V}$, $I_C = 60\text{ A}$, $R_G = 10\ \Omega$, $V_{GE} = 15\text{ V}$ (see Figure 27. Test circuit for inductive load switching)	-	66	-	ns
t_r	Current rise time		-	38	-	ns
$(di/dt)_{on}$	Turn-on current slope		-	1216	-	A/ μ s
$t_{d(off)}$	Turn-off delay time		-	210	-	ns
t_f	Current fall time		-	20	-	ns
$E_{on}^{(1)}$	Turn-on switching energy		-	1590	-	μ J
$E_{off}^{(2)}$	Turn-off switching energy		-	900	-	μ J
E_{ts}	Total switching energy	-	2490	-	μ J	
$t_{d(on)}$	Turn-on delay time	$V_{CE} = 400\text{ V}$, $I_C = 60\text{ A}$, $R_G = 10\ \Omega$, $V_{GE} = 15\text{ V}$, $T_J = 175\text{ }^\circ\text{C}$ (see Figure 27. Test circuit for inductive load switching)	-	59	-	ns
t_r	Current rise time		-	40	-	ns
$(di/dt)_{on}$	Turn-on current slope		-	1230	-	A/ μ s
$t_{d(off)}$	Turn-off-delay time		-	242	-	ns
t_f	Current fall time		-	147	-	ns
$E_{on}^{(1)}$	Turn-on switching energy		-	2860	-	μ J
$E_{off}^{(2)}$	Turn-off switching energy		-	1255	-	μ J
E_{ts}	Total switching energy	-	4115	-	μ J	

1. Including the reverse recovery of the diode.
2. Including the tail of the collector current.

Table 6. Diode switching characteristics (inductive load)

Symbol	Parameter	Test conditions	Min.	Typ.	Max.	Unit
t_{rr}	Reverse recovery time	$I_F = 60\text{ A}$, $V_R = 400\text{ V}$, $V_{GE} = 15\text{ V}$, $di/dt = 100\text{ A}/\mu\text{s}$ (see Figure 27. Test circuit for inductive load switching)	-	60	-	ns
Q_{rr}	Reverse recovery charge		-	99	-	nC
I_{rrm}	Reverse recovery current		-	3.3	-	A
dI_{rr}/dt	Peak rate of fall of reverse recovery current during t_b		-	187	-	A/ μ s
E_{rr}	Reverse recovery energy		-	68	-	μ J
t_{rr}	Reverse recovery time	$I_F = 60\text{ A}$, $V_R = 400\text{ V}$, $V_{GE} = 15\text{ V}$, $di/dt = 100\text{ A}/\mu\text{s}$, $T_J = 175\text{ }^\circ\text{C}$ (see Figure 27. Test circuit for inductive load switching)	-	310	-	ns
Q_{rr}	Reverse recovery charge		-	1550	-	nC
I_{rrm}	Reverse recovery current		-	10	-	A
dI_{rr}/dt	Peak rate of fall of reverse recovery current during t_b		-	59	-	A/ μ s
E_{rr}	Reverse recovery energy		-	674	-	μ J

2.1 Electrical characteristics (curves)
Figure 1. Output characteristics ($T_J = 25^\circ\text{C}$)

Figure 2. Output characteristics ($T_J = 175^\circ\text{C}$)

Figure 3. Transfer characteristics

Figure 4. Collector current vs case temperature

Figure 5. Power dissipation vs case temperature

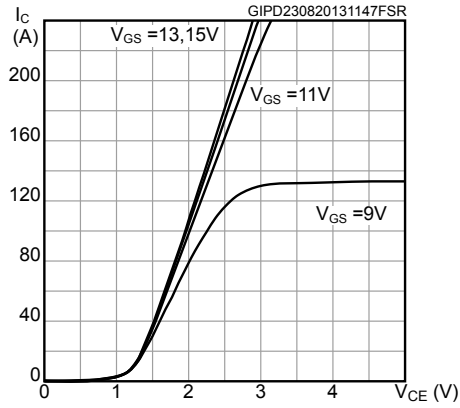
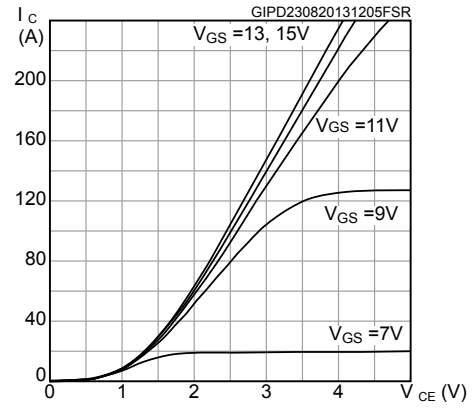
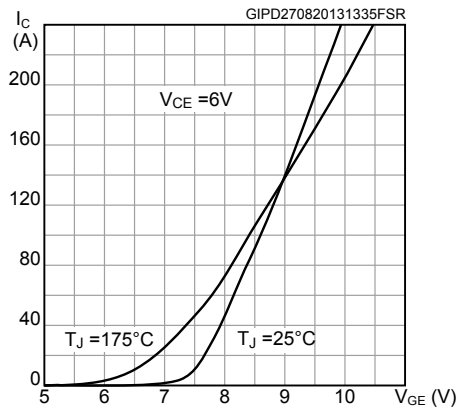
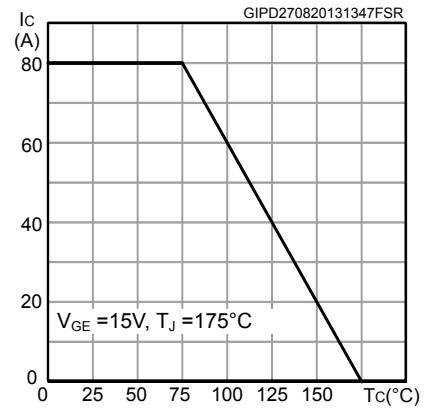
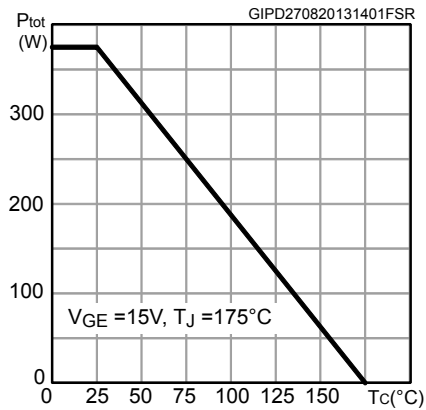
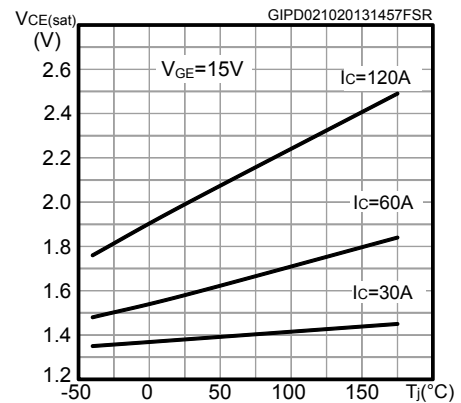
Figure 6. $V_{CE(sat)}$ vs junction temperature

Figure 7. $V_{CE(sat)}$ vs collector current

Figure 8. Forward bias safe operating area

Figure 9. Diode V_F vs forward current

Figure 10. Normalized $V_{(BR)CES}$ vs junction temperature

Figure 11. Normalized $V_{GE(th)}$ vs junction temperature

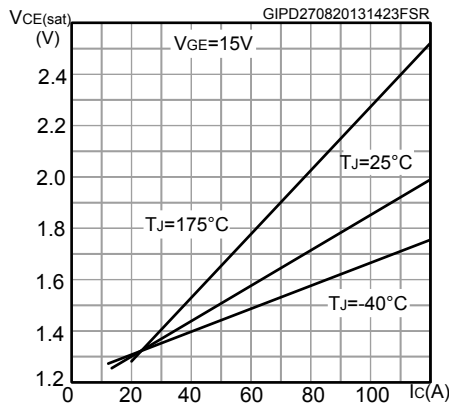
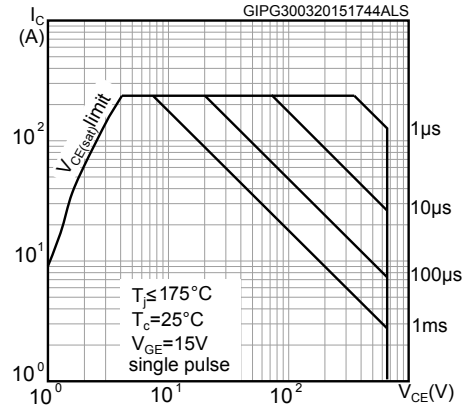
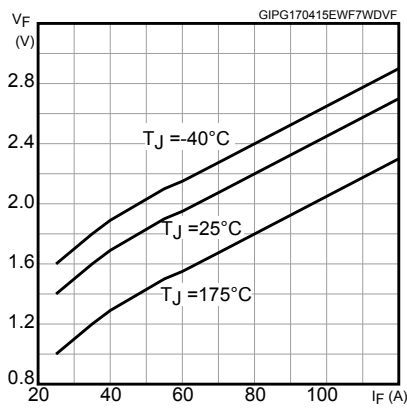
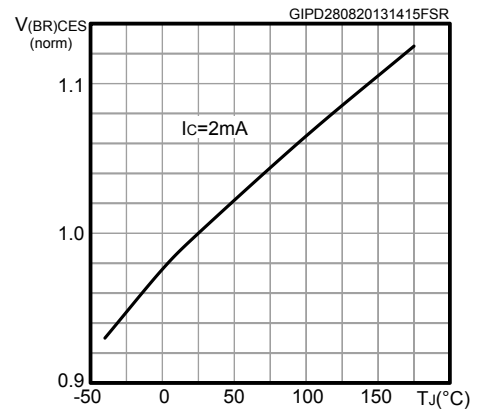
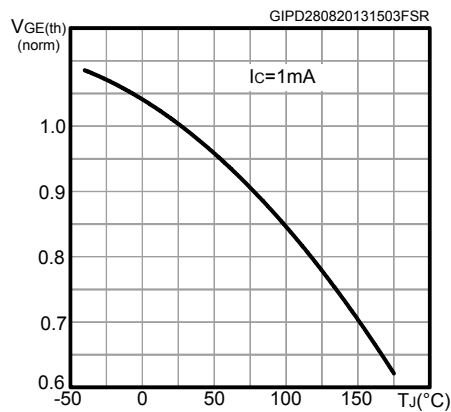
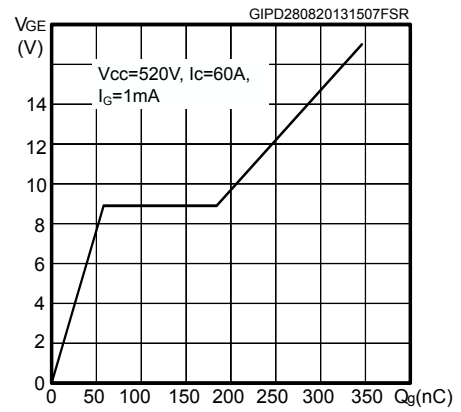
Figure 12. Gate charge vs gate-emitter voltage

Figure 13. Switching energy vs temperature

Figure 14. Switching energy vs gate resistance

Figure 15. Switching energy vs collector current

Figure 16. Switching energy vs collector emitter voltage

Figure 17. Switching times vs collector current

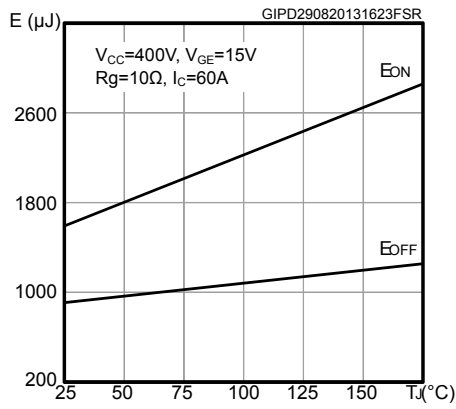
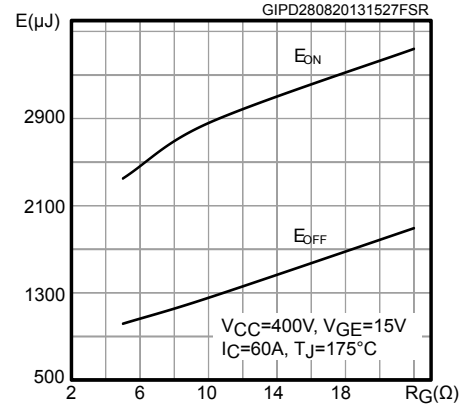
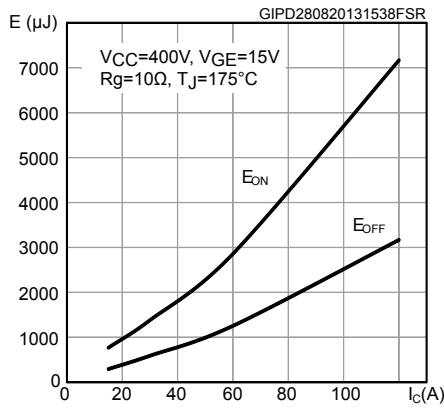
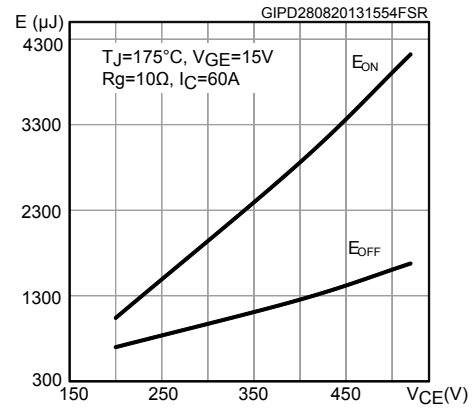
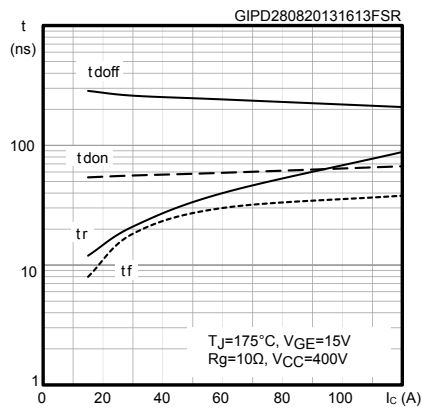
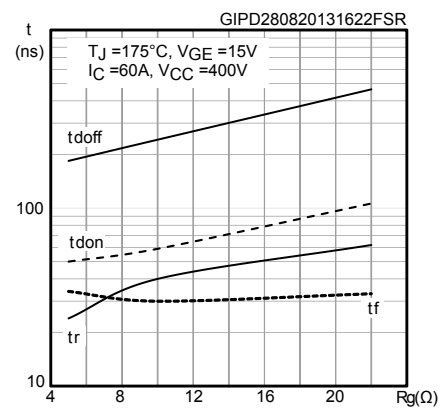
Figure 18. Switching times vs gate resistance

Figure 19. Reverse recovery current vs diode current slope

Figure 20. Reverse recovery time vs diode current slope

Figure 21. Reverse recovery charge vs diode current slope

Figure 22. Reverse recovery energy vs diode current slope

Figure 23. Capacitance variations

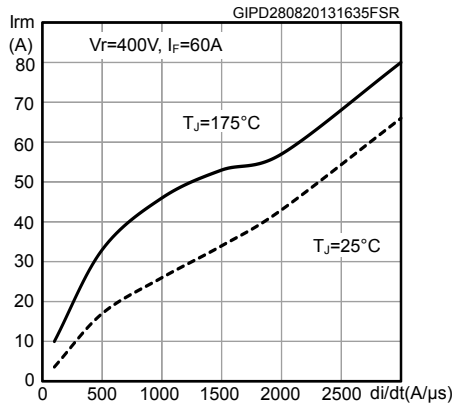
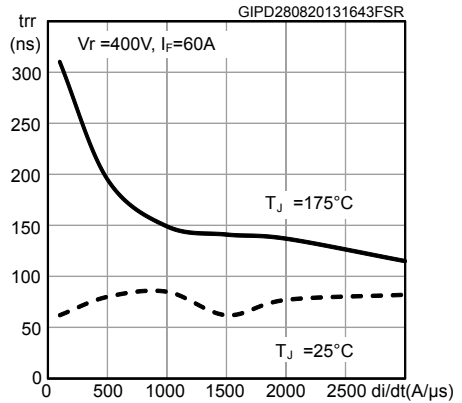
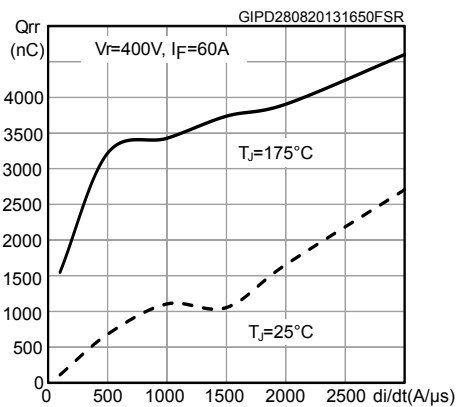
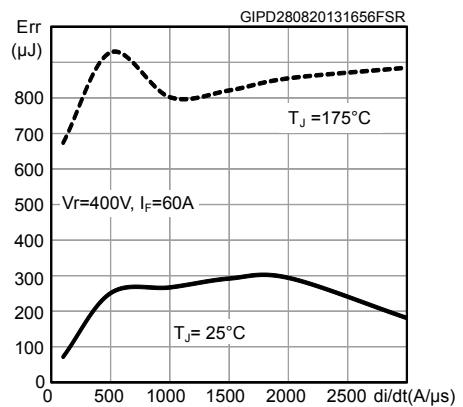
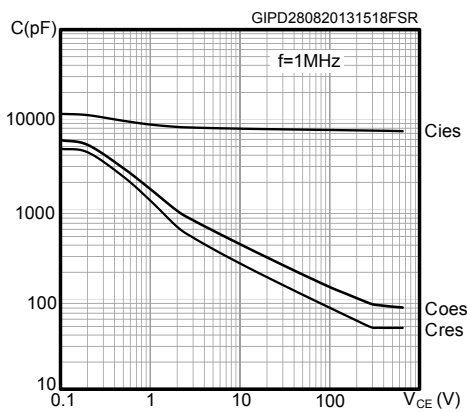
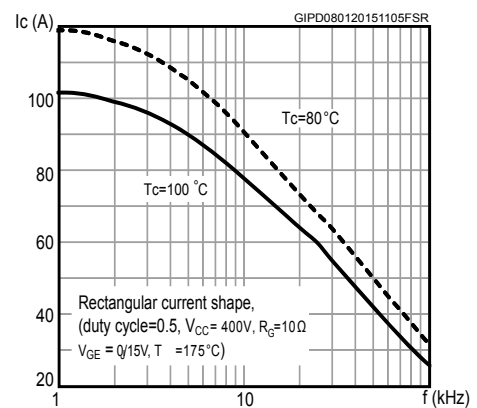
Figure 24. Collector current vs switching frequency

Figure 25. Thermal impedance for IGBT

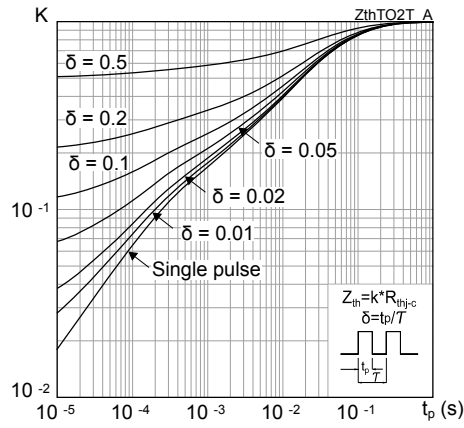
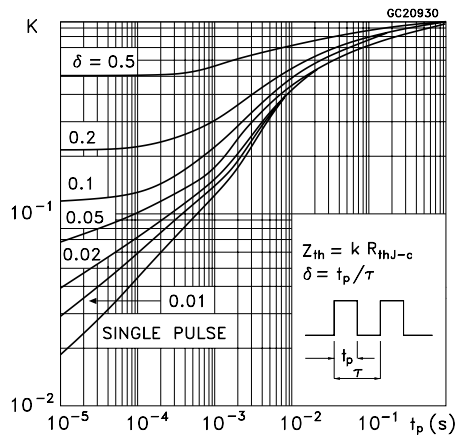

Figure 26. Thermal impedance for diode



3 Test circuits

Figure 27. Test circuit for inductive load switching

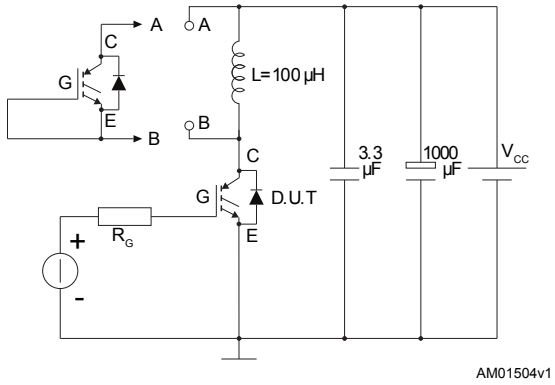

Figure 28. Gate charge test circuit

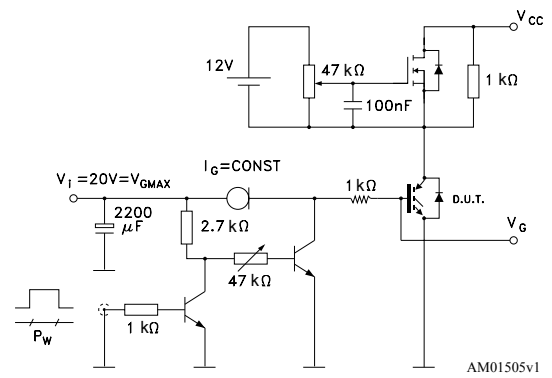

Figure 29. Switching waveform

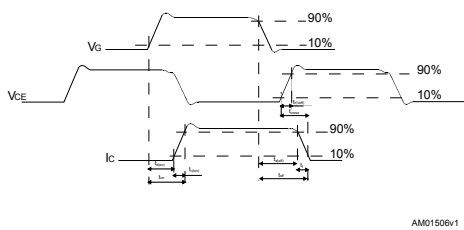
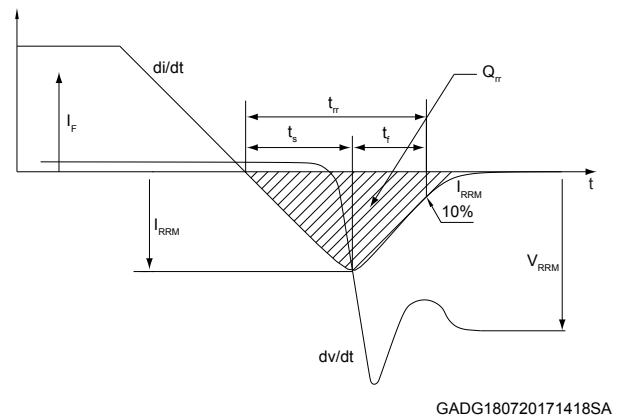

Figure 30. Diode reverse recovery waveform





4 Package information

In order to meet environmental requirements, ST offers these devices in different grades of **ECOPACK** packages, depending on their level of environmental compliance. ECOPACK specifications, grade definitions and product status are available at: www.st.com. ECOPACK is an ST trademark.

4.1 TO-247 package information

Figure 31. TO-247 package outline

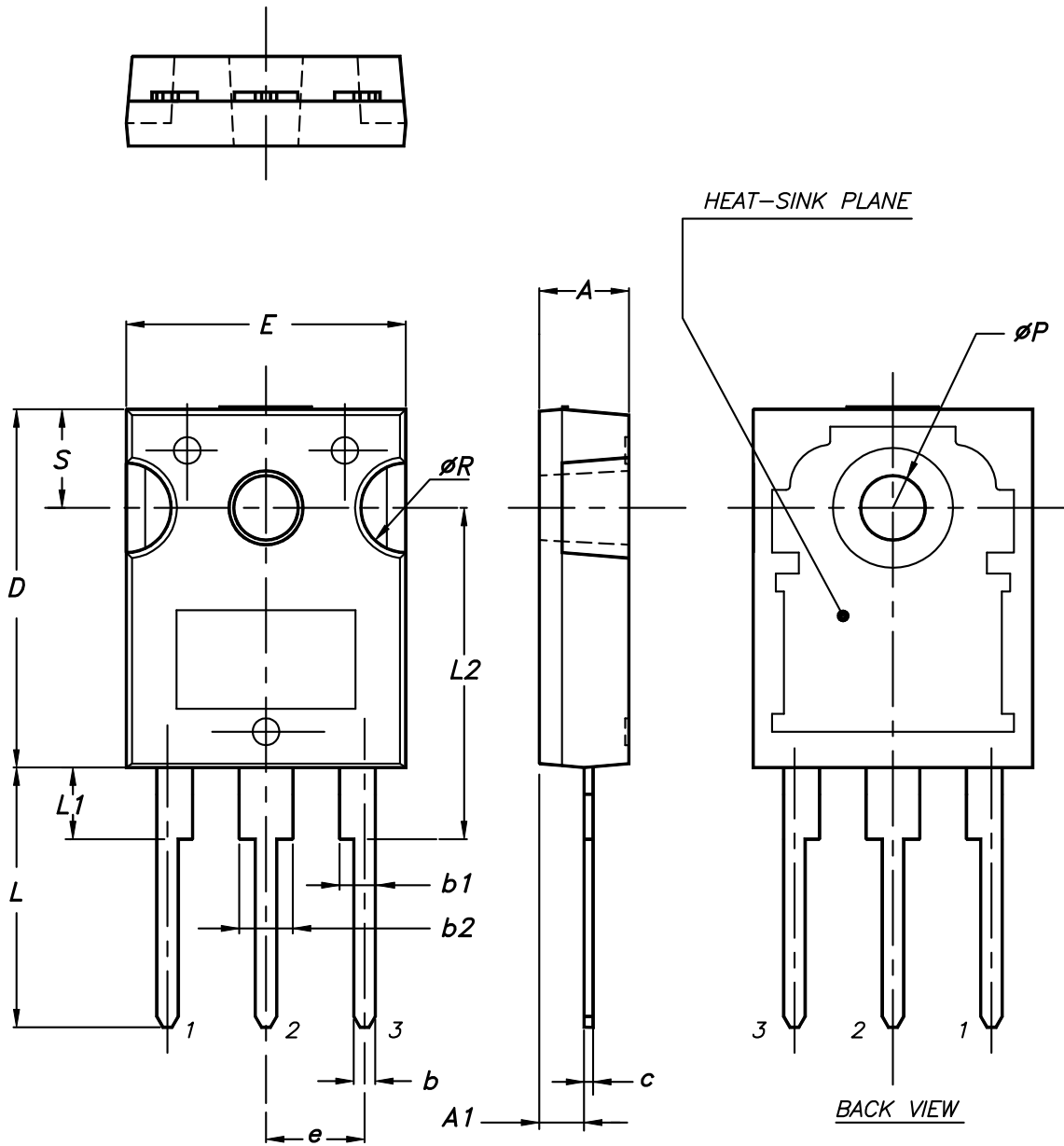

0075325_9

Table 7. TO-247 package mechanical data

Dim.	mm		
	Min.	Typ.	Max.
A	4.85		5.15
A1	2.20		2.60
b	1.0		1.40
b1	2.0		2.40
b2	3.0		3.40
c	0.40		0.80
D	19.85		20.15
E	15.45		15.75
e	5.30	5.45	5.60
L	14.20		14.80
L1	3.70		4.30
L2		18.50	
ØP	3.55		3.65
ØR	4.50		5.50
S	5.30	5.50	5.70

4.2 TO-247 long leads package information

Figure 32. TO-247 long leads package outline

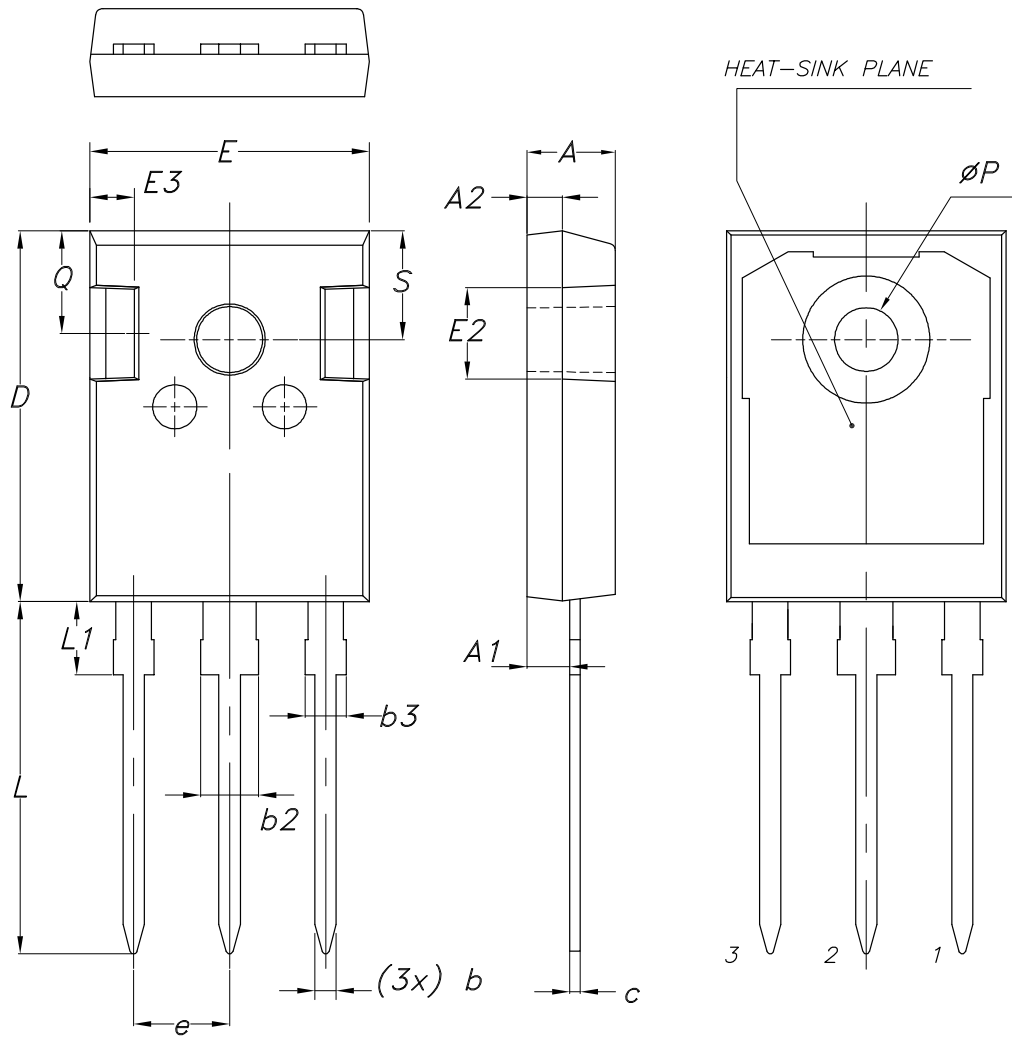

8463846_2_F

Table 8. TO-247 long leads package mechanical data

Dim.	mm		
	Min.	Typ.	Max.
A	4.90	5.00	5.10
A1	2.31	2.41	2.51
A2	1.90	2.00	2.10
b	1.16		1.26
b2			3.25
b3			2.25
c	0.59		0.66
D	20.90	21.00	21.10
E	15.70	15.80	15.90
E2	4.90	5.00	5.10
E3	2.40	2.50	2.60
e	5.34	5.44	5.54
L	19.80	19.92	20.10
L1			4.30
P	3.50	3.60	3.70
Q	5.60		6.00
S	6.05	6.15	6.25

4.3 TO-3P package information

Figure 33. TO-3P package outline

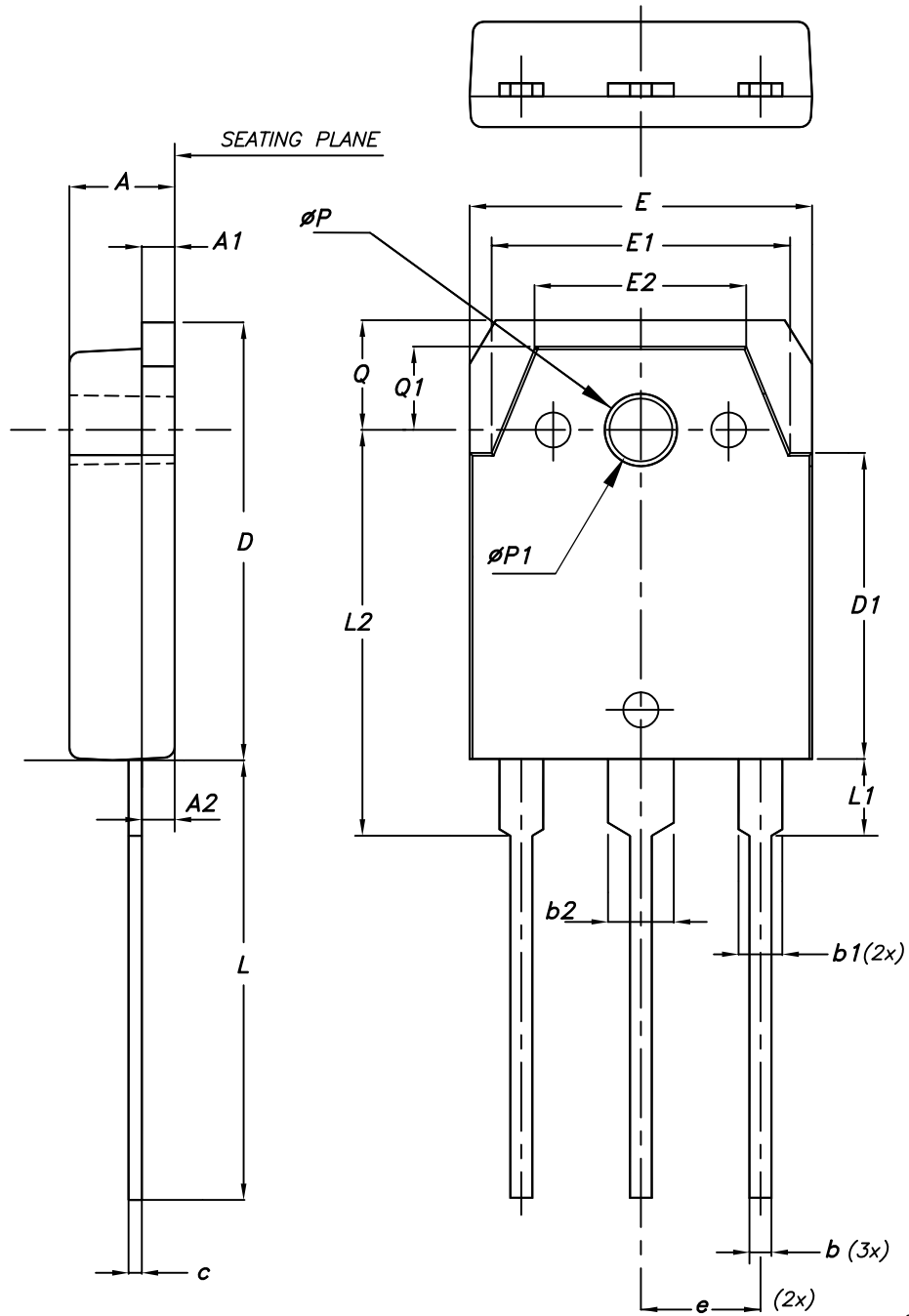

8045950_3

Table 9. TO-3P package mechanical data

Dim.	mm		
	Min.	Typ.	Max.
A	4.60	4.80	5.00
A1	1.45	1.50	1.65
A2	1.20	1.40	1.60
b	0.80	1.00	1.20
b1	1.80	2.00	2.20
b2	2.80	3.00	3.20
c	0.55	0.60	0.75
D	19.70	19.90	20.10
D1	13.70	13.90	14.10
E	15.40	15.60	15.80
E1	13.40	13.60	13.80
E2	9.40	9.60	9.90
e	5.15	5.45	5.75
L	19.80	20.00	20.20
L1	3.30	3.50	3.70
L2	18.20	18.40	18.60
ØP	3.30	3.40	3.50
ØP1	3.10	3.20	3.30
Q	4.80	5.00	5.20
Q1	3.60	3.80	4.00

5 Ordering information

Table 10. Order codes

Order code	Marking	Package	Packing
STGW60H65DFB	GW60H65DFB	TO-247	Tube
STGWA60H65DFB	G60H65DFB	TO-247 long leads	Tube
STGWT60H65DFB	GWT60H65DFB	TO-3P	Tube

Revision history

Table 11. Document revision history

Date	Revision	Changes
12-Mar-2013	1	Initial release.
30-Aug-2013	2	Document status promoted from preliminary to production data. Added <i>Section 2.1: Electrical characteristics (curves)</i> .
31-Oct-2013	3	Updated $V_{CE(sat)}$ in <i>Table 4: Static characteristics</i> .
24-Feb-2014	4	Updated title and description in cover page.
09-Jan-2015	5	Updated features in cover page, <i>Table 2: Absolute maximum ratings</i> , and <i>Table 6: IGBT switching characteristics (inductive load)</i> . Updated <i>Figure 5: Collector current vs. case temperature</i> , <i>Figure 6: Power dissipation vs. case temperature</i> , <i>Figure 8: VCE(sat) vs. collector current</i> , <i>Figure 18: Switching times vs collector current</i> , <i>Figure 19: Switching times vs gate resistance</i> and <i>Figure 20: Reverse recovery current vs. diode current slope</i> . Added <i>Figure 25: Collector current vs. switching frequency</i> . Updated <i>Section 4: Package information</i> . Minor text changes.
23-Mar-2015	6	Text edits throughout document. In document, added new order code STGWA60H65DFB in TO-247 long leads package, with accompanying information and data. In <i>Section 2.1: Electrical characteristics (curves)</i> : - updated <i>Figure 2, Figure 3, Figure 4, Figure 7, Figure 9</i>
17-Apr-2015	7	Text edits throughout document. In <i>Section 2: Electrical characteristics</i> : - updated <i>Table 4: Static characteristics</i> - updated <i>Table 6: IGBT switching characteristics (inductive load)</i> In <i>Section 2.1: Electrical characteristics (curves)</i> : - updated <i>Figure 3 and Figure 9</i>
22-Jul-2019	8	Updated Table 1. Absolute maximum ratings . Minor text changes.

Contents

1	Electrical ratings	2
2	Electrical characteristics	3
2.1	Electrical characteristics (curves)	5
3	Test circuits	10
4	Package information	11
4.1	TO-247 package information	11
4.2	TO-247 long leads package information	13
4.3	TO-3P package information	15
5	Ordering information	18
	Revision history	19