

## Trench gate field-stop 600 V, 30 A high speed HB series IGBT

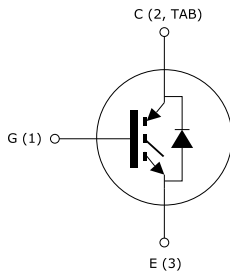
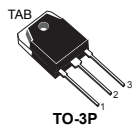
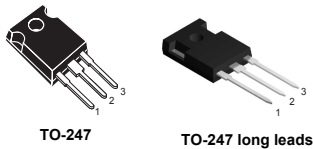

### Features

- Maximum junction temperature:  $T_J = 175\text{ °C}$
- High speed switching series
- Minimized tail current
- Low saturation voltage:  $V_{CE(sat)} = 1.55\text{ V (typ.) @ } I_C = 30\text{ A}$
- Tight parameter distribution
- Safe paralleling
- Positive  $V_{CE(sat)}$  temperature coefficient
- Low thermal resistance
- Very fast soft recovery antiparallel diode

### Applications

- Photovoltaic inverters
- High frequency converters

### Description

These devices are IGBTs developed using an advanced proprietary trench gate field-stop structure. These devices are part of the new HB series of IGBTs, which represent an optimum compromise between conduction and switching loss to maximize the efficiency of any frequency converter. Furthermore, the slightly positive  $V_{CE(sat)}$  temperature coefficient and very tight parameter distribution result in safer paralleling operation.

#### Product status link

[STGW30H60DFB](#)
[STGWA30H60DFB](#)
[STGWT30H60DFB](#)

# 1 Electrical ratings

**Table 1. Absolute maximum ratings**

Symbol	Parameter	Value	Unit
$V_{CES}$	Collector-emitter voltage ( $V_{GE} = 0$ V)	600	V
$I_C$	Continuous collector current at $T_C = 25$ °C	60	A
	Continuous collector current at $T_C = 100$ °C	30	
$I_{CP}^{(1)}$	Pulsed collector current	120	
$V_{GE}$	Gate-emitter voltage	±20	V
	Transient gate-emitter voltage	±30	
$I_F$	Continuous forward current at $T_C = 25$ °C	60	A
	Continuous forward current at $T_C = 100$ °C	30	
$I_{FP}^{(1)}$	Pulsed forward current	120	
$P_{TOT}$	Total power dissipation at $T_C = 25$ °C	260	W
$T_{STG}$	Storage temperature range	- 55 to 150	°C
$T_J$	Operating junction temperature range	- 55 to 175	

1. Pulse width limited by maximum junction temperature.

**Table 2. Thermal data**

Symbol	Parameter	Value	Unit
$R_{thJC}$	Thermal resistance junction-case IGBT	0.58	°C/W
$R_{thJC}$	Thermal resistance junction-case diode	2.08	
$R_{thJA}$	Thermal resistance junction-ambient	50	

## 2 Electrical characteristics

$T_C = 25\text{ °C}$  unless otherwise specified

**Table 3. Static characteristics**

Symbol	Parameter	Test conditions	Min.	Typ.	Max.	Unit
$V_{(BR)CES}$	Collector-emitter breakdown voltage	$V_{GE} = 0\text{ V}, I_C = 2\text{ mA}$	600			V
$V_{CE(sat)}$	Collector-emitter saturation voltage	$V_{GE} = 15\text{ V}, I_C = 30\text{ A}$		1.55	2	V
		$V_{GE} = 15\text{ V}, I_C = 30\text{ A}, T_J = 125\text{ °C}$		1.65		
		$V_{GE} = 15\text{ V}, I_C = 30\text{ A}, T_J = 175\text{ °C}$		1.75		
$V_F$	Forward on-voltage	$I_F = 30\text{ A}$		2	2.6	V
		$I_F = 30\text{ A}, T_J = 125\text{ °C}$		1.7		
		$I_F = 30\text{ A}, T_J = 175\text{ °C}$		1.6		
$V_{GE(th)}$	Gate threshold voltage	$V_{CE} = V_{GE}, I_C = 1\text{ mA}$	5	6	7	V
$I_{CES}$	Collector cut-off current	$V_{GE} = 0\text{ V}, V_{CE} = 600\text{ V}$			25	$\mu\text{A}$
$I_{GES}$	Gate-emitter leakage current	$V_{CE} = 0\text{ V}, V_{GE} = \pm 20\text{ V}$			$\pm 250$	nA

**Table 4. Dynamic characteristics**

Symbol	Parameter	Test conditions	Min.	Typ.	Max.	Unit
$C_{ies}$	Input capacitance	$V_{CE} = 25\text{ V}, f = 1\text{ MHz}, V_{GE} = 0\text{ V}$	-	3659	-	pF
$C_{oes}$	Output capacitance		-	101	-	
$C_{res}$	Reverse transfer capacitance		-	76	-	
$Q_g$	Total gate charge	$V_{CC} = 520\text{ V}, I_C = 30\text{ A}, V_{GE} = 0\text{ to }15\text{ V}$ (see Figure 28. Gate charge test circuit)	-	149	-	nC
$Q_{ge}$	Gate-emitter charge		-	25	-	
$Q_{gc}$	Gate-collector charge		-	62	-	

**Table 5. IGBT switching characteristics (inductive load)**

Symbol	Parameter	Test conditions	Min.	Typ.	Max.	Unit	
$t_{d(on)}$	Turn-on delay time	$V_{CE} = 400\text{ V}$ , $I_C = 30\text{ A}$ , $V_{GE} = 15\text{ V}$ , $R_G = 10\ \Omega$ (see Figure 27. Test circuit for inductive load switching)	-	37	-	ns	
$t_r$	Current rise time		-	14.6	-		
$(di/dt)_{on}$	Turn-on current slope		-	1643	-	A/ $\mu\text{s}$	
$t_{d(off)}$	Turn-off-delay time		$V_{CE} = 400\text{ V}$ , $I_C = 30\text{ A}$ , $V_{GE} = 15\text{ V}$ , $R_G = 10\ \Omega$ , $T_J = 175\text{ }^\circ\text{C}$ (see Figure 27. Test circuit for inductive load switching)	-	146	-	ns
$t_f$	Current fall time			-	23	-	
$E_{on}^{(1)}$	Turn-on switching energy			-	383	-	$\mu\text{J}$
$E_{off}^{(2)}$	Turn-off switching energy			-	293	-	
$E_{ts}$	Total switching energy			-	676	-	
$t_{d(on)}$	Turn-on delay time			$V_{CE} = 400\text{ V}$ , $I_C = 30\text{ A}$ , $V_{GE} = 15\text{ V}$ , $R_G = 10\ \Omega$ , $T_J = 175\text{ }^\circ\text{C}$ (see Figure 27. Test circuit for inductive load switching)	-	35	-
$t_r$	Current rise time	-			16.1	-	
$(di/dt)_{on}$	Turn-on current slope	-			1496	-	A/ $\mu\text{s}$
$t_{d(off)}$	Turn-off-delay time	$V_{CE} = 400\text{ V}$ , $I_C = 30\text{ A}$ , $V_{GE} = 15\text{ V}$ , $R_G = 10\ \Omega$ , $T_J = 175\text{ }^\circ\text{C}$ (see Figure 27. Test circuit for inductive load switching)			-	158	-
$t_f$	Current fall time		-		65	-	
$E_{on}^{(1)}$	Turn-on switching energy		-		794	-	$\mu\text{J}$
$E_{off}^{(2)}$	Turn-off switching energy		-		572	-	
$E_{ts}$	Total switching energy		-		1366	-	

1. Including the reverse recovery of the diode.
2. Including the tail of the collector current.

**Table 6. Diode switching characteristics (inductive load)**

Symbol	Parameter	Test conditions	Min.	Typ.	Max.	Unit
$t_{rr}$	Reverse recovery time	$I_F = 30\text{ A}$ , $V_R = 400\text{ V}$ , $V_{GE} = 15\text{ V}$ , $di/dt = 1000\text{ A}/\mu\text{s}$ (see Figure 27. Test circuit for inductive load switching)	-	53	-	ns
$Q_{rr}$	Reverse recovery charge		-	384	-	nC
$I_{rrm}$	Reverse recovery current		-	14.5	-	A
$di_{rr}/dt$	Peak rate of fall of reverse recovery current during $t_b$		-	788	-	A/ $\mu\text{s}$
$E_{rr}$	Reverse recovery energy		-	104	-	$\mu\text{J}$
$t_{rr}$	Reverse recovery time	$I_F = 30\text{ A}$ , $V_R = 400\text{ V}$ , $V_{GE} = 15\text{ V}$ , $di/dt = 1000\text{ A}/\mu\text{s}$ , $T_J = 175\text{ }^\circ\text{C}$ (see Figure 27. Test circuit for inductive load switching)	-	104	-	ns
$Q_{rr}$	Reverse recovery charge		-	1352	-	nC
$I_{rrm}$	Reverse recovery current		-	26	-	A
$di_{rr}/dt$	Peak rate of fall of reverse recovery current during $t_b$		-	310	-	A/ $\mu\text{s}$
$E_{rr}$	Reverse recovery energy		-	407	-	$\mu\text{J}$

## 2.1 Electrical characteristics (curves)

**Figure 1. Power dissipation vs case temperature**

**Figure 2. Collector current vs case temperature**

**Figure 3. Output characteristics ( $T_J = 25^\circ C$ )**

**Figure 4. Output characteristics ( $T_J = 175^\circ C$ )**

**Figure 5.  $V_{CE(sat)}$  vs junction temperature**

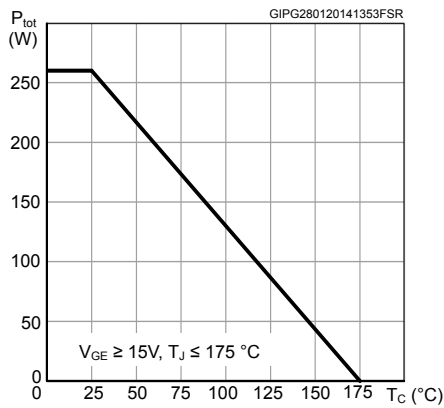
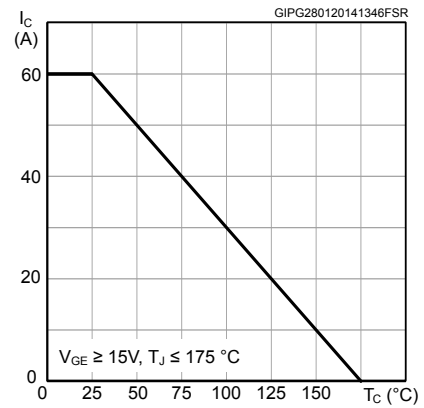
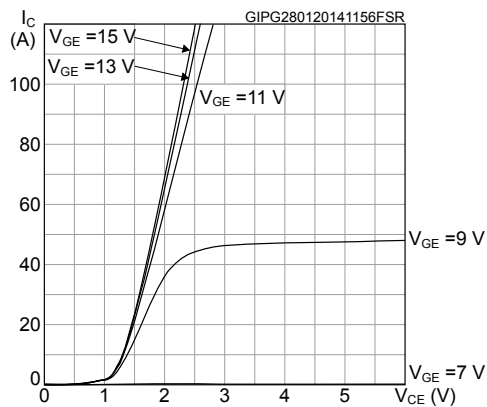
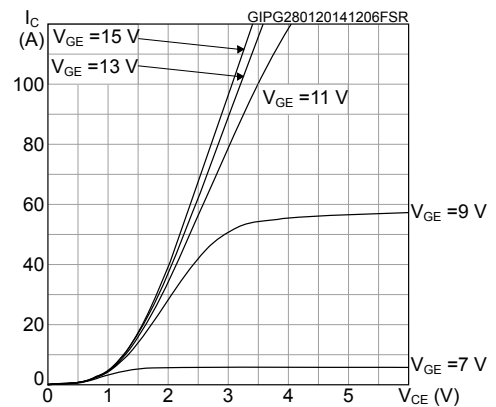
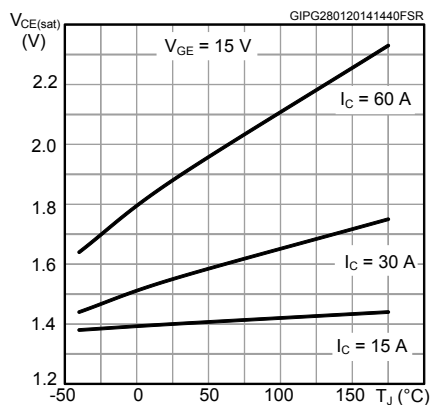
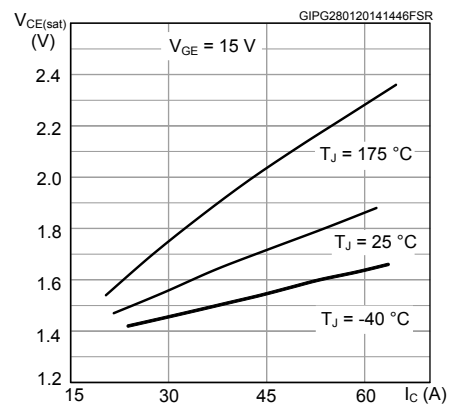
**Figure 6.  $V_{CE(sat)}$  vs collector current**

Figure 7. Collector current vs switching frequency

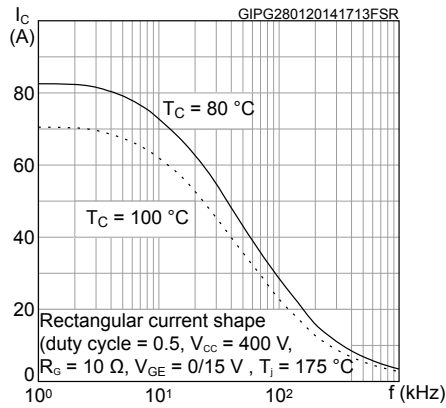

Figure 8. Forward bias safe operating area

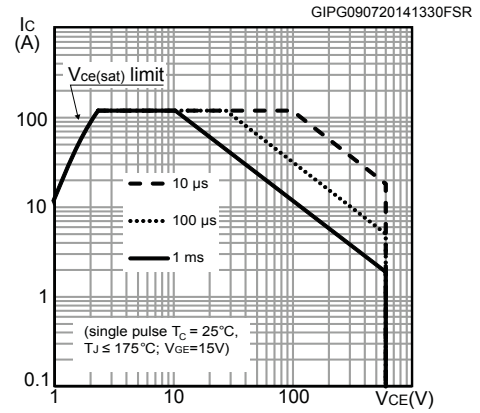

Figure 9. Transfer characteristics

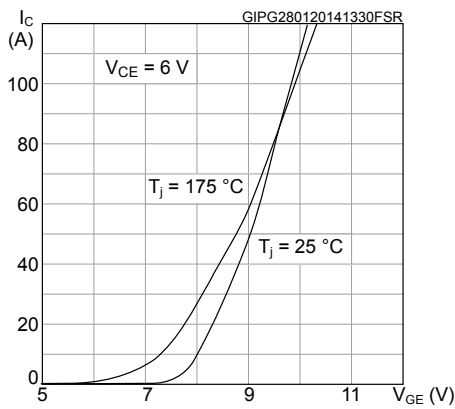

Figure 10. Diode Vf vs forward current

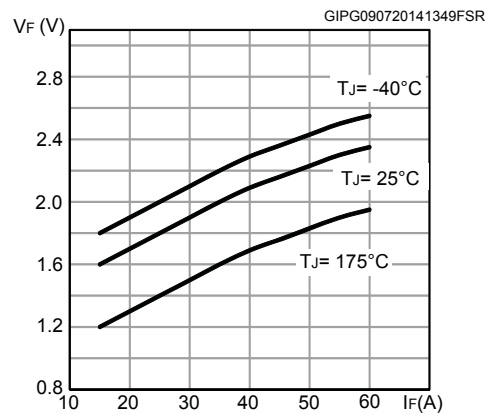

Figure 11. Normalized Vge(th) vs junction temperature

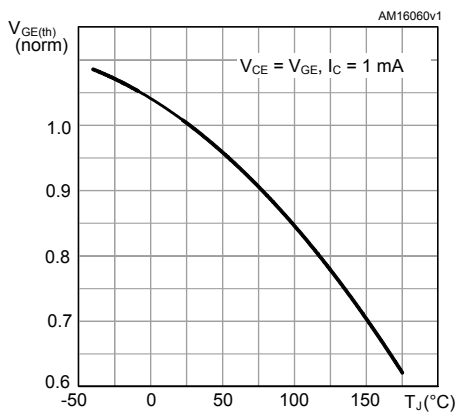
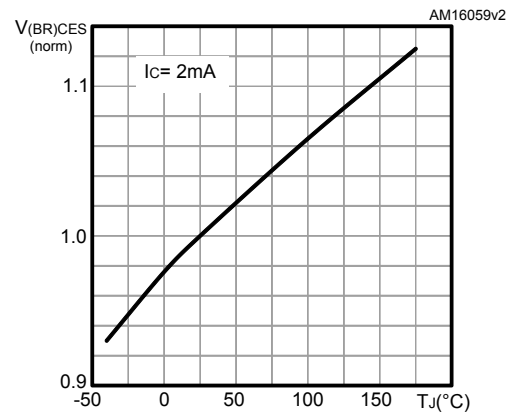
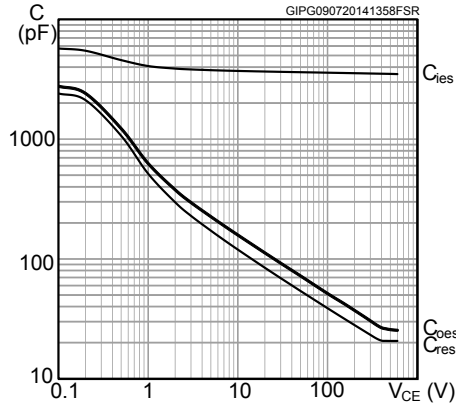
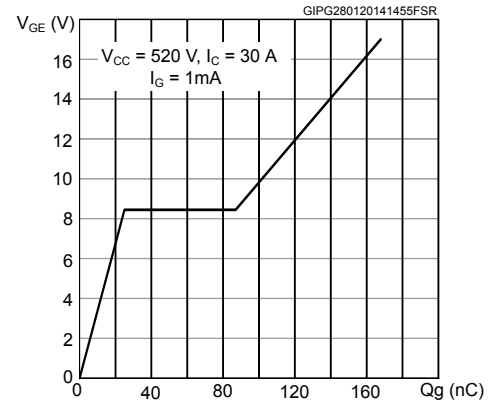
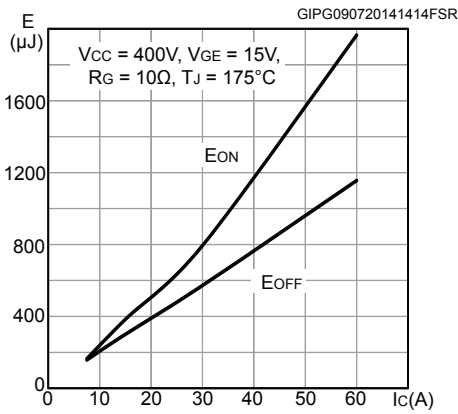
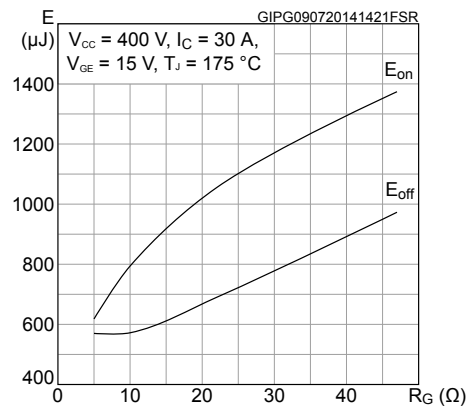
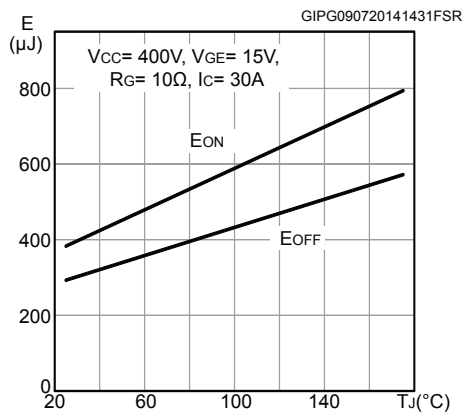
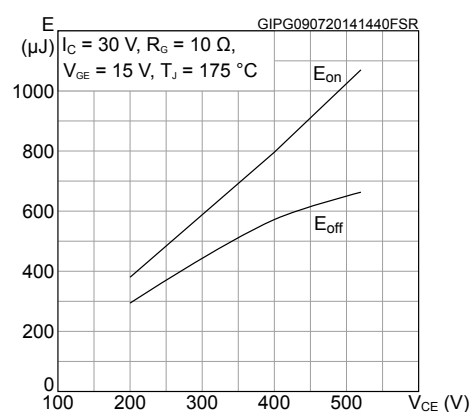

Figure 12. Normalized V(BR)CES vs junction temperature



**Figure 13. Capacitance variations**

**Figure 14. Gate charge vs. gate-emitter voltage**

**Figure 15. Switching energy vs collector current**

**Figure 16. Switching energy vs gate resistance**

**Figure 17. Switching energy vs temperature**

**Figure 18. Switching energy vs collector emitter voltage**

**Figure 19. Switching times vs collector current**

**Figure 20. Switching times vs gate resistance**

**Figure 21. Reverse recovery current vs diode current slope**

**Figure 22. Reverse recovery time vs diode current slope**

**Figure 23. Reverse recovery charge vs diode current slope**

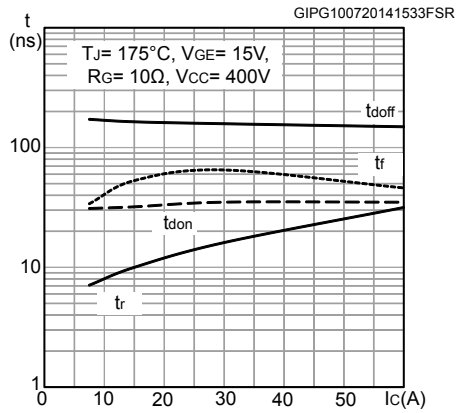
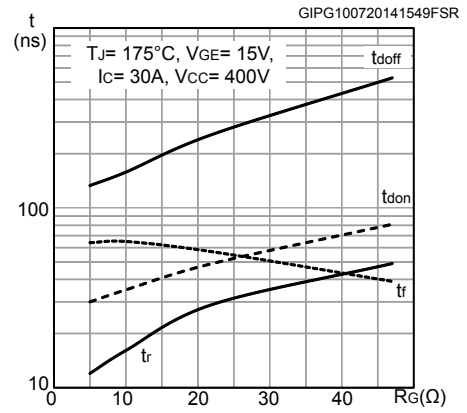
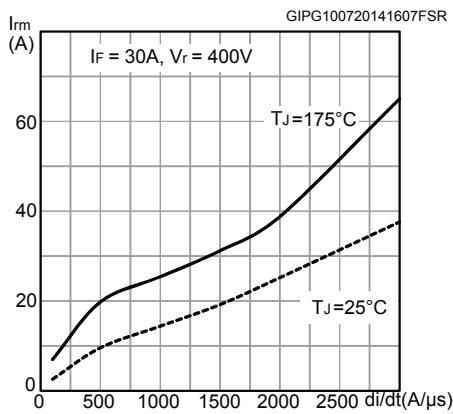
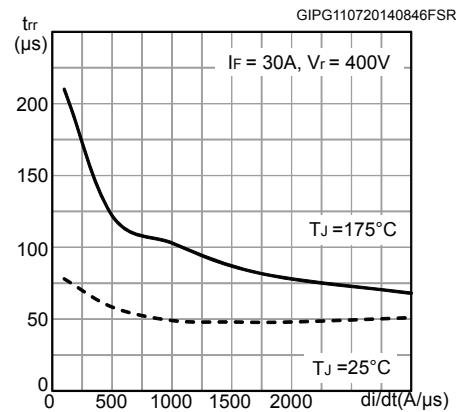
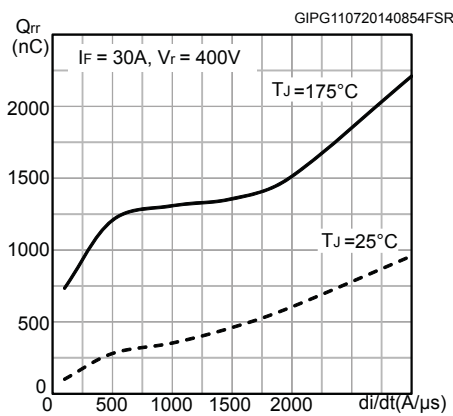
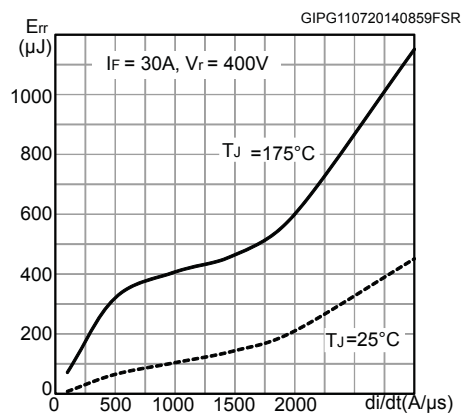
**Figure 24. Reverse recovery energy vs diode current slope**



Figure 25. Thermal impedance for IGBT

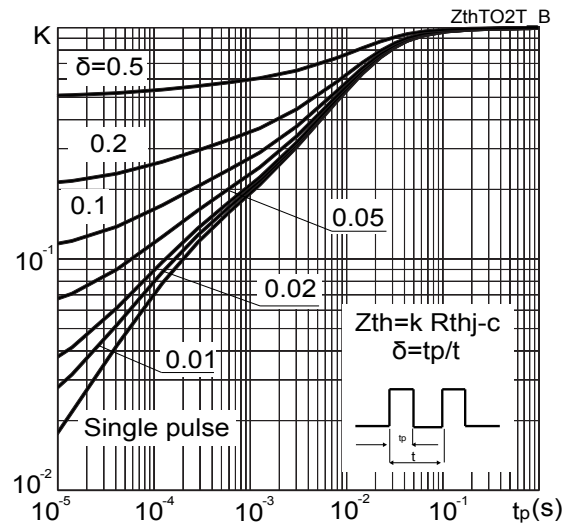
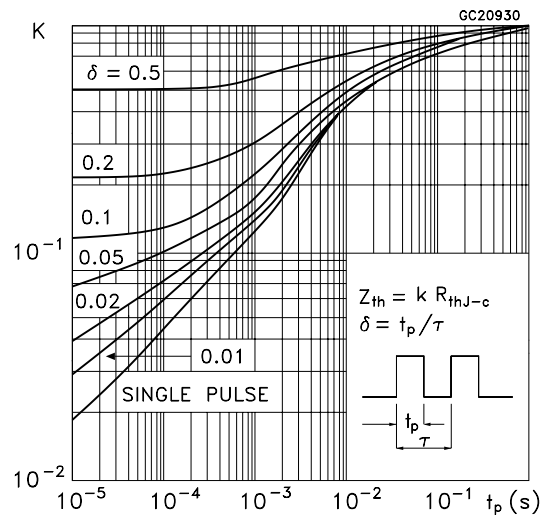

Figure 26. Thermal impedance for diode



### 3 Test circuits

Figure 27. Test circuit for inductive load switching

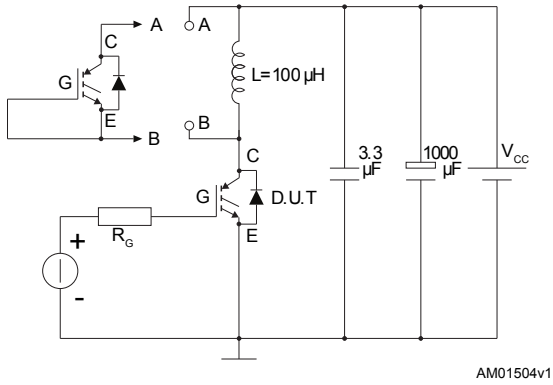

Figure 28. Gate charge test circuit

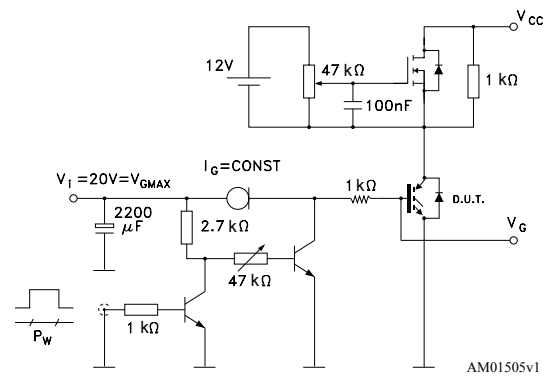

Figure 29. Switching waveform

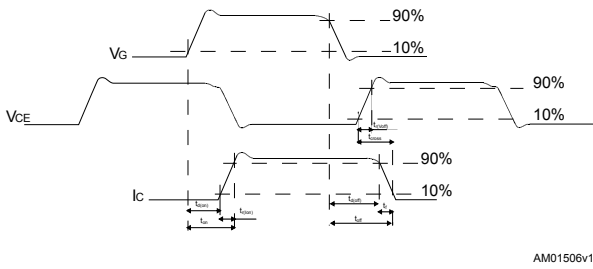
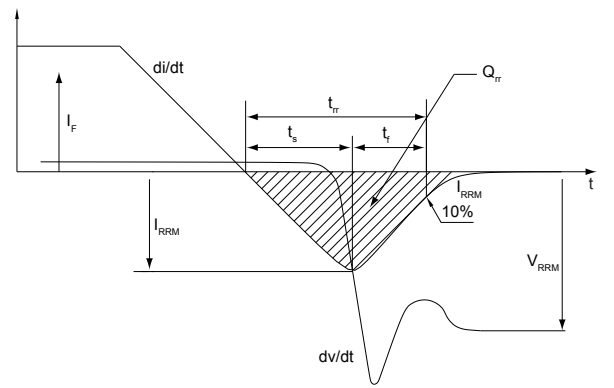

Figure 30. Diode reverse recovery waveform



## 4 Package information

---

In order to meet environmental requirements, ST offers these devices in different grades of **ECOPACK** packages, depending on their level of environmental compliance. ECOPACK specifications, grade definitions and product status are available at: [www.st.com](http://www.st.com). ECOPACK is an ST trademark.

### 4.1 TO-247 package information

Figure 31. TO-247 package outline

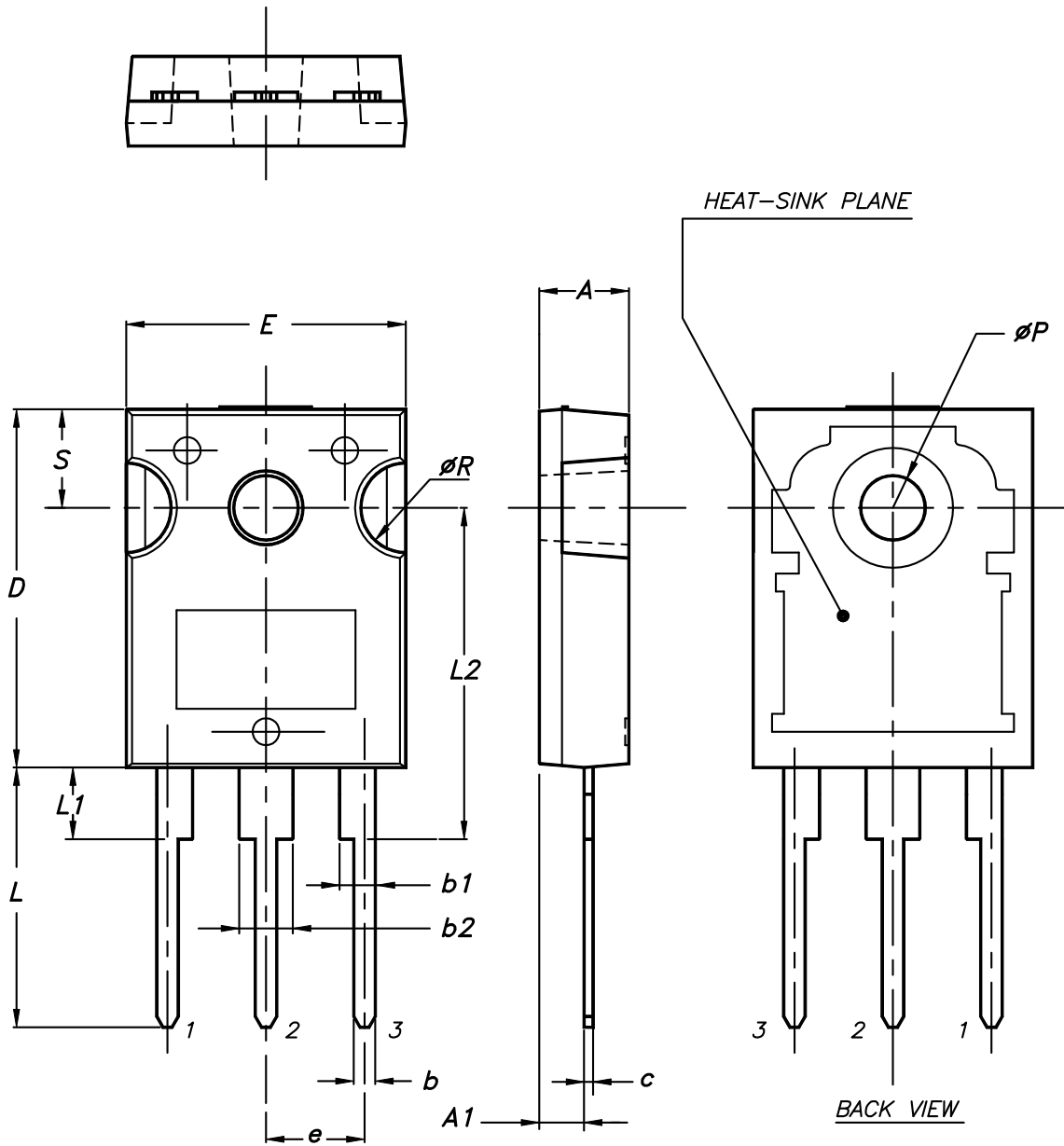

0075325\_9

**Table 7. TO-247 package mechanical data**

Dim.	mm		
	Min.	Typ.	Max.
A	4.85		5.15
A1	2.20		2.60
b	1.0		1.40
b1	2.0		2.40
b2	3.0		3.40
c	0.40		0.80
D	19.85		20.15
E	15.45		15.75
e	5.30	5.45	5.60
L	14.20		14.80
L1	3.70		4.30
L2		18.50	
ØP	3.55		3.65
ØR	4.50		5.50
S	5.30	5.50	5.70

## 4.2 TO-247 long leads package information

Figure 32. TO-247 long leads package outline

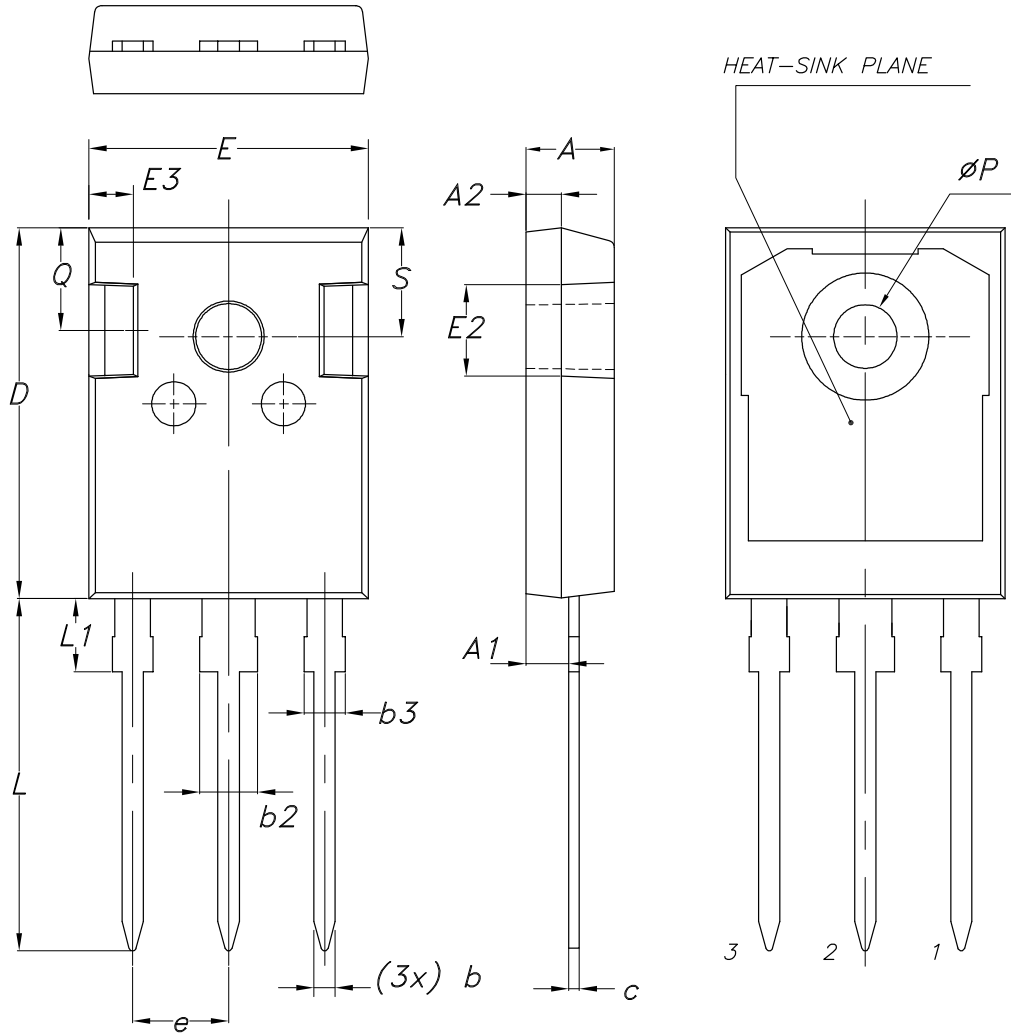

8463846\_2\_F

**Table 8. TO-247 long leads package mechanical data**

Dim.	mm		
	Min.	Typ.	Max.
A	4.90	5.00	5.10
A1	2.31	2.41	2.51
A2	1.90	2.00	2.10
b	1.16		1.26
b2			3.25
b3			2.25
c	0.59		0.66
D	20.90	21.00	21.10
E	15.70	15.80	15.90
E2	4.90	5.00	5.10
E3	2.40	2.50	2.60
e	5.34	5.44	5.54
L	19.80	19.92	20.10
L1			4.30
P	3.50	3.60	3.70
Q	5.60		6.00
S	6.05	6.15	6.25

### 4.3 TO-3P package information

Figure 33. TO-3P package outline

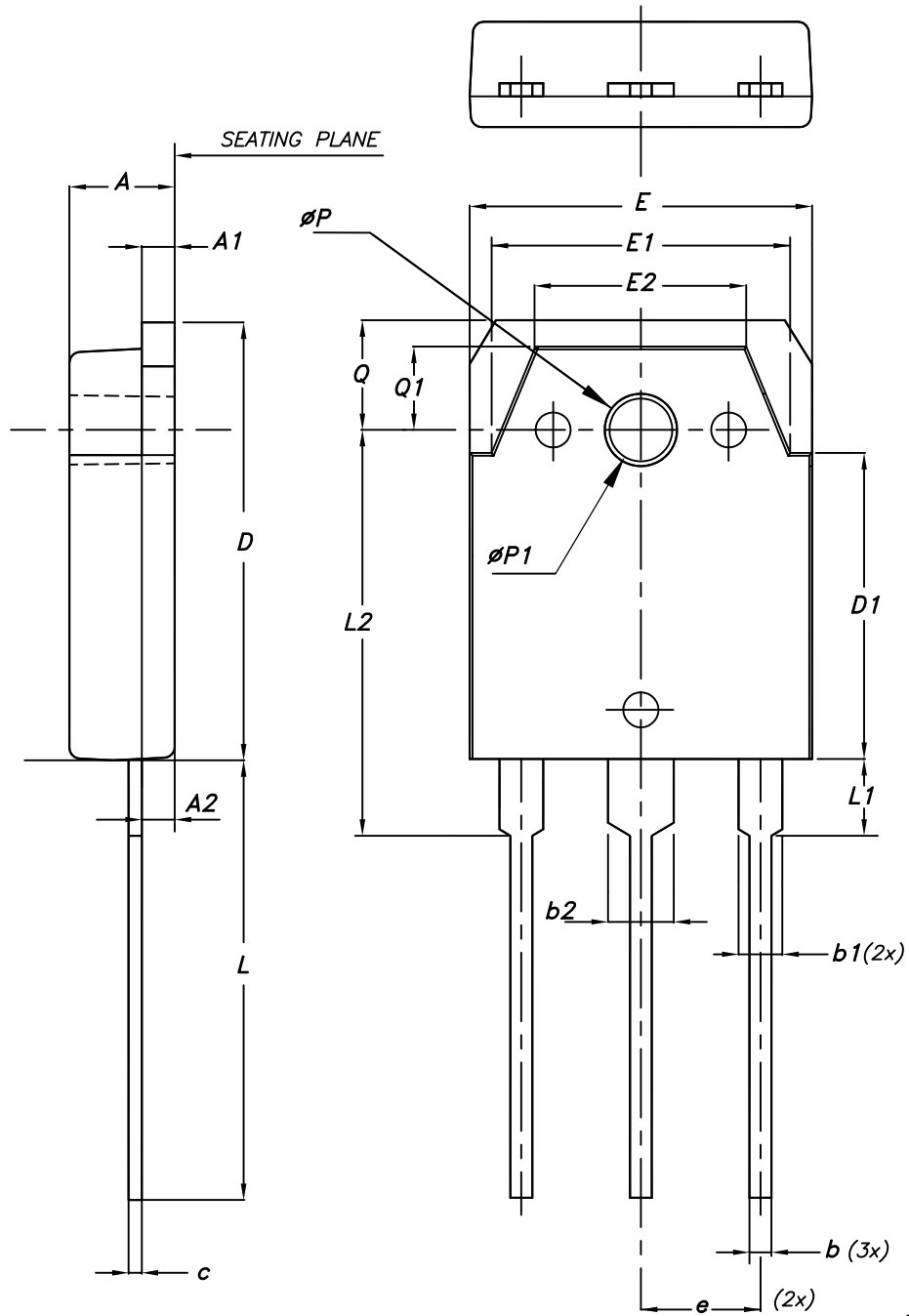

8045950\_3



Table 9. TO-3P package mechanical data

Dim.	mm		
	Min.	Typ.	Max.
A	4.60	4.80	5.00
A1	1.45	1.50	1.65
A2	1.20	1.40	1.60
b	0.80	1.00	1.20
b1	1.80	2.00	2.20
b2	2.80	3.00	3.20
c	0.55	0.60	0.75
D	19.70	19.90	20.10
D1	13.70	13.90	14.10
E	15.40	15.60	15.80
E1	13.40	13.60	13.80
E2	9.40	9.60	9.90
e	5.15	5.45	5.75
L	19.80	20.00	20.20
L1	3.30	3.50	3.70
L2	18.20	18.40	18.60
ØP	3.30	3.40	3.50
ØP1	3.10	3.20	3.30
Q	4.80	5.00	5.20
Q1	3.60	3.80	4.00

## 5 Ordering information

**Table 10. Order codes**

Order code	Marking	Package	Packing
STGW30H60DFB	GW30H60DFB	TO-247	Tube
STGWA30H60DFB	GWA30H60DFB	TO-247 long leads	
STGWT30H60DFB	GWT30H60DFB	TO-3P	

## Revision history

**Table 11. Document revision history**

Date	Revision	Changes
01-Aug-2014	1	Initial version.
17-Feb-2016	2	Modified: <i>Table 2, Table 4 and 6</i> Modified: <i>Figure 16</i> Updated: <i>Section 3</i> Updated: <i>Section 4.1: TO-247, STGW30H60DFB</i> Minor text changes
04-Nov-2016	3	Added device in TO-247 long leads. Document updated accordingly. Minor text changes.
10-May-2019	4	Modified <a href="#">Figure 3. Output characteristics (<math>T_J = 25\text{ }^\circ\text{C}</math>)</a> , <a href="#">Figure 4. Output characteristics (<math>T_J = 175\text{ }^\circ\text{C}</math>)</a> , <a href="#">Figure 9. Transfer characteristics</a> , <a href="#">Figure 7. Collector current vs switching frequency</a> , <a href="#">Figure 18. Switching energy vs collector emitter voltage</a> . Minor text changes.

## Contents

<b>1</b>	<b>Electrical ratings</b> .....	<b>2</b>
<b>2</b>	<b>Electrical characteristics</b> .....	<b>3</b>
<b>2.1</b>	<b>Electrical characteristics (curves)</b> .....	<b>5</b>
<b>3</b>	<b>Test circuits</b> .....	<b>10</b>
<b>4</b>	<b>Package mechanical data</b> .....	<b>11</b>
<b>4.1</b>	<b>TO-247 package information</b> .....	<b>11</b>
<b>4.2</b>	<b>TO-247 long leads package information</b> .....	<b>13</b>
<b>4.3</b>	<b>TO-3P package information</b> .....	<b>15</b>
<b>5</b>	<b>Ordering information</b> .....	<b>18</b>
	<b>Revision history</b> .....	<b>19</b>