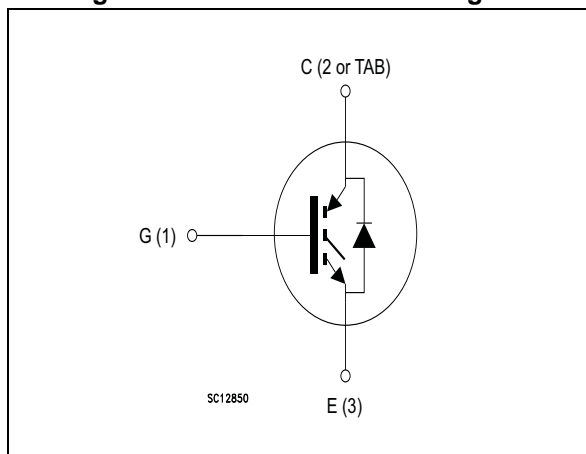

Figure 1. Internal schematic diagram



### Features

- Maximum junction temperature:  $T_J = 175\text{ }^\circ\text{C}$
- High speed switching series
- Minimized tail current
- $V_{CE(sat)} = 1.6\text{ V (typ.) @ } I_C = 60\text{ A}$
- Tight parameters distribution
- Safe paralleling
- Low thermal resistance
- Low  $V_F$  soft recovery co-packaged diode
- Lead free package

### Applications

- Induction heating
- Microwave oven
- Resonant converters

### Description

This device is an IGBT developed using an advanced proprietary trench gate and field stop structure. The device is part of the new "HB" series of IGBTs, which represent an optimum compromise between conduction and switching losses to maximize the efficiency of any frequency converter. Furthermore, a slightly positive  $V_{CE(sat)}$  temperature coefficient and very tight parameter distribution result in safer paralleling operation.

Table 1. Device summary

Order code	Marking	Package	Packaging
STGW60H60DLFB	GW60H60DLFB	TO-247	Tube
STGWT60H60DLFB	GWT60H60DLFB	TO-3P	Tube

# Contents

<b>1</b>	<b>Electrical ratings</b> .....	<b>3</b>
<b>2</b>	<b>Electrical characteristics</b> .....	<b>4</b>
	2.1 Electrical characteristics (curves) .....	6
<b>3</b>	<b>Test circuits</b> .....	<b>11</b>
<b>4</b>	<b>Package mechanical data</b> .....	<b>12</b>
<b>5</b>	<b>Revision history</b> .....	<b>16</b>

# 1 Electrical ratings

**Table 2. Absolute maximum ratings**

Symbol	Parameter	Value	Unit
$V_{CES}$	Collector-emitter voltage ( $V_{GE} = 0$ )	600	V
$I_C$	Continuous collector current at $T_C = 25\text{ °C}$	80 <sup>(1)</sup>	A
$I_C$	Continuous collector current at $T_C = 100\text{ °C}$	60	A
$I_{CP}$ <sup>(2)</sup>	Pulsed collector current	240	A
$V_{GE}$	Gate-emitter voltage	$\pm 20$	V
$I_F$	Continuous forward current at $T_C = 25\text{ °C}$	80 <sup>(1)</sup>	A
$I_F$	Continuous forward current at $T_C = 100\text{ °C}$	60	A
$I_{FP}$ <sup>(2)</sup>	Pulsed forward current	240	A
$P_{TOT}$	Total dissipation at $T_C = 25\text{ °C}$	375	W
$T_{STG}$	Storage temperature range	- 55 to 150	°C
$T_J$	Operating junction temperature	- 55 to 175	°C

1. Current level is limited by bond wires
2. Pulse width limited by maximum junction temperature

**Table 3. Thermal data**

Symbol	Parameter	Value	Unit
$R_{thJC}$	Thermal resistance junction-case IGBT	0.4	°C/W
$R_{thJC}$	Thermal resistance junction-case diode	1.47	°C/W
$R_{thJA}$	Thermal resistance junction-ambient	50	°C/W

## 2 Electrical characteristics

$T_J = 25\text{ °C}$  unless otherwise specified.

**Table 4. Static characteristics**

Symbol	Parameter	Test conditions	Min.	Typ.	Max.	Unit
$V_{(BR)CES}$	Collector-emitter breakdown voltage ( $V_{GE} = 0$ )	$I_C = 2\text{ mA}$	600			V
$V_{CE(sat)}$	Collector-emitter saturation voltage	$V_{GE} = 15\text{ V}, I_C = 60\text{ A}$		1.6	2	V
		$V_{GE} = 15\text{ V}, I_C = 60\text{ A}$ $T_J = 125\text{ °C}$		1.75		
		$V_{GE} = 15\text{ V}, I_C = 60\text{ A}$ $T_J = 175\text{ °C}$		1.85		
$V_F$	Forward on-voltage	$I_F = 60\text{ A}$		1.8	2.1	V
		$I_F = 60\text{ A}, T_J = 125\text{ °C}$		1.55		
		$I_F = 60\text{ A}, T_J = 175\text{ °C}$		1.5		
$V_{GE(th)}$	Gate threshold voltage	$V_{CE} = V_{GE}, I_C = 1\text{ mA}$	5	6	7	V
$I_{CES}$	Collector cut-off current ( $V_{GE} = 0$ )	$V_{CE} = 600\text{ V}$			25	$\mu\text{A}$
$I_{GES}$	Gate-emitter leakage current ( $V_{CE} = 0$ )	$V_{GE} = \pm 20\text{ V}$			250	nA

**Table 5. Dynamic characteristics**

Symbol	Parameter	Test conditions	Min.	Typ.	Max.	Unit
$C_{ies}$	Input capacitance	$V_{CE} = 25\text{ V}, f = 1\text{ MHz},$ $V_{GE} = 0$	-	7792	-	pF
$C_{oes}$	Output capacitance		-	262	-	pF
$C_{res}$	Reverse transfer capacitance		-	158	-	pF
$Q_g$	Total gate charge	$V_{CC} = 480\text{ V}, I_C = 60\text{ A},$ $V_{GE} = 15\text{ V},$ see <a href="#">Figure 27</a>	-	306	-	nC
$Q_{ge}$	Gate-emitter charge		-	126	-	nC
$Q_{gc}$	Gate-collector charge		-	58	-	nC

Table 6. IGBT switching characteristics (inductive load)

Symbol	Parameter	Test conditions	Min.	Typ.	Max.	Unit
$t_{d(off)}$	Turn-off delay time	$V_{CE} = 400\text{ V}$ , $I_C = 60\text{ A}$ , $R_G = 5\ \Omega$ , $V_{GE} = 15\text{ V}$ , see <a href="#">Figure 25</a>		160		ns
$t_f$	Current fall time		-	18	-	ns
$E_{off}^{(1)}$	Turn-off switching losses		-	626	-	$\mu\text{J}$
$t_{d(off)}$	Turn-off delay time	$V_{CE} = 400\text{ V}$ , $I_C = 60\text{ A}$ , $R_G = 5\ \Omega$ , $V_{GE} = 15\text{ V}$ , $T_J = 175\text{ }^\circ\text{C}$ , see <a href="#">Figure 25</a>		184		ns
$t_f$	Current fall time		-	117	-	ns
$E_{off}^{(1)}$	Turn-off switching losses		-	1017	-	$\mu\text{J}$

1. Turn-off losses include also the tail of the collector current.

Table 7. IGBT switching characteristics (capacitive load)

Symbol	Parameter	Test conditions	Min.	Typ.	Max.	Unit
$E_{off}^{(1)}$	Turn-off switching losses	$V_{CC} = 320\text{ V}$ , $R_G = 10\ \Omega$ , $I_C = 60\text{ A}$ , $L = 100\ \mu\text{H}$ , $C_{snub} = 20\text{ nF}$ , see <a href="#">Figure 26</a>	-	450	-	$\mu\text{J}$
		$V_{CC} = 320\text{ V}$ , $R_G = 10\ \Omega$ , $I_C = 60\text{ A}$ , $L = 100\ \mu\text{H}$ , $C_{snub} = 20\text{ nF}$ , $T_J = 175\text{ }^\circ\text{C}$ , see <a href="#">Figure 26</a>	-	785	-	

1. Turn-off losses include also the tail of the collector current.

## 2.1 Electrical characteristics (curves)

Figure 2. Power dissipation vs. case temperature

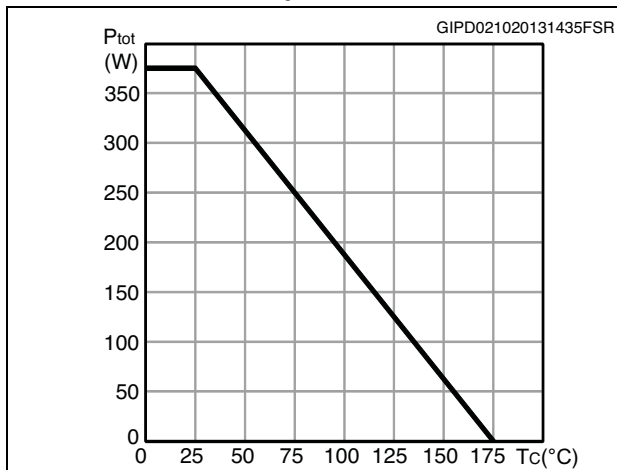

Figure 3. Collector current vs. case temperature

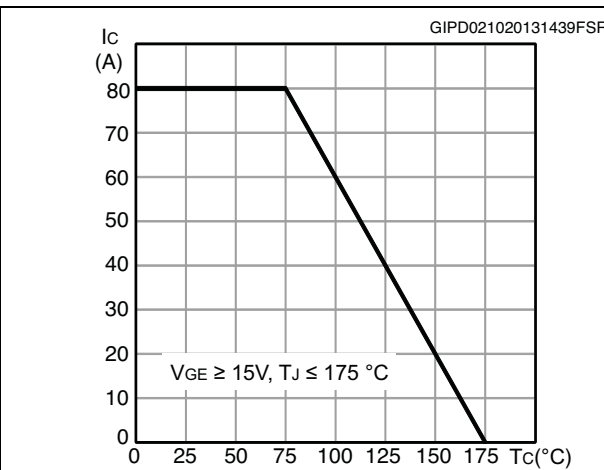

Figure 4. Output characteristics (T<sub>J</sub> = 25°C)

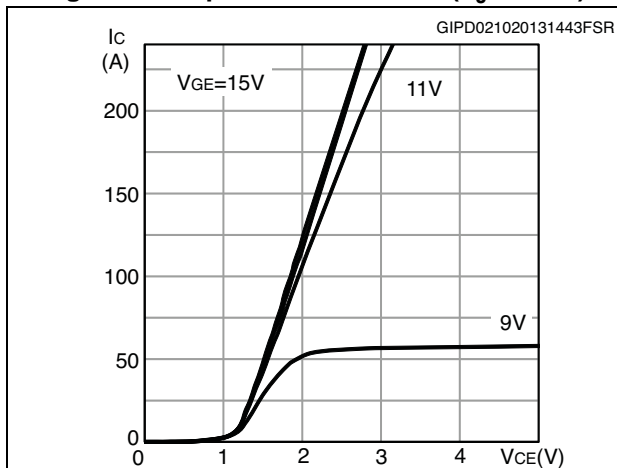

Figure 5. Output characteristics (T<sub>J</sub> = 175°C)

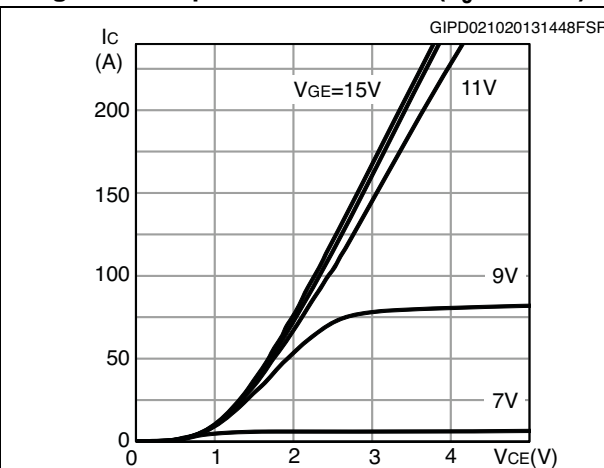

Figure 6. V<sub>CE(sat)</sub> vs. junction temperature

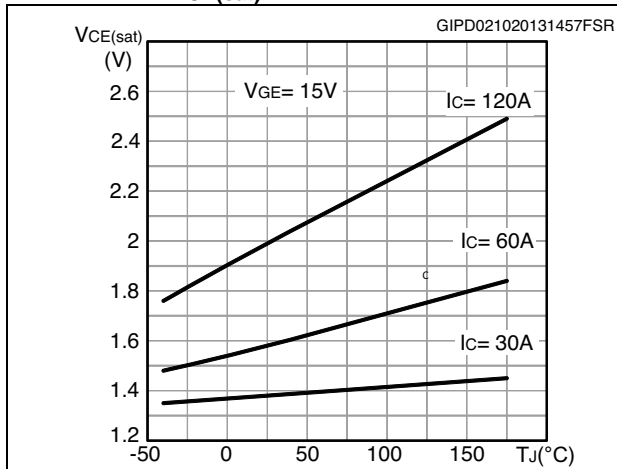

Figure 7. V<sub>CE(sat)</sub> vs. collector current

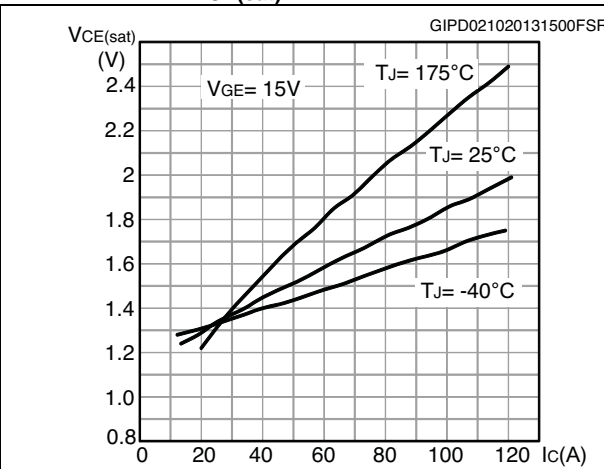

Figure 8. Collector current vs. switching frequency

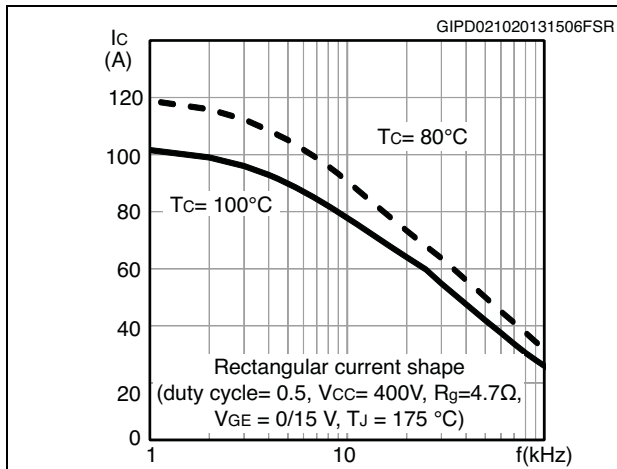

Figure 9. Forward bias safe operating area

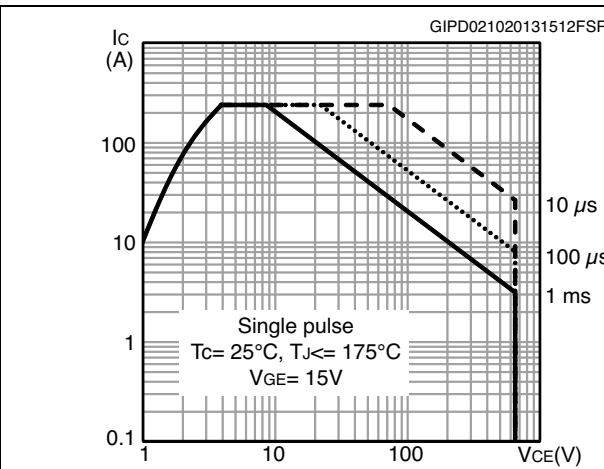

Figure 10. Transfer characteristics

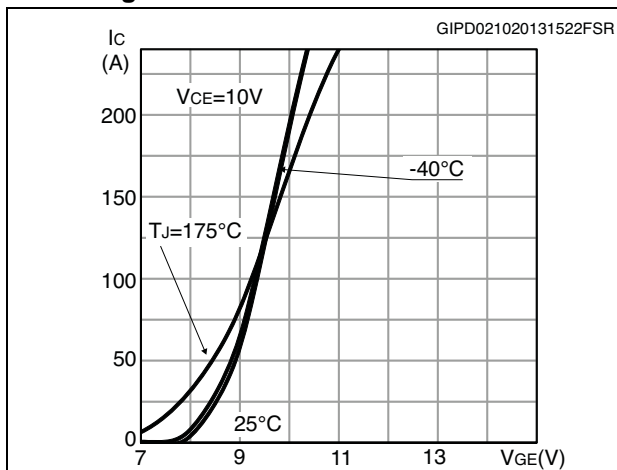

Figure 11. Diode VF vs. forward current

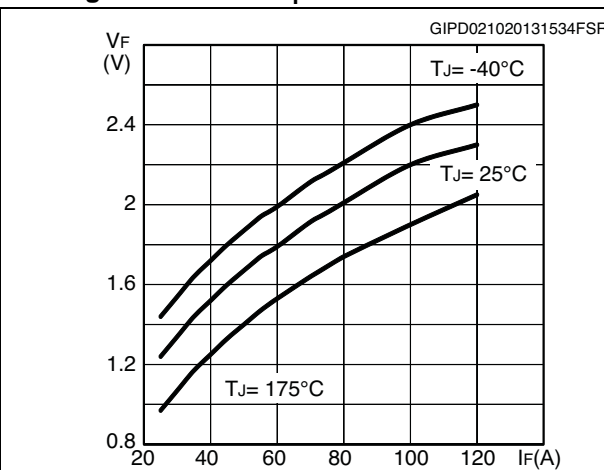

Figure 12. Normalized VGE(th) vs junction temperature

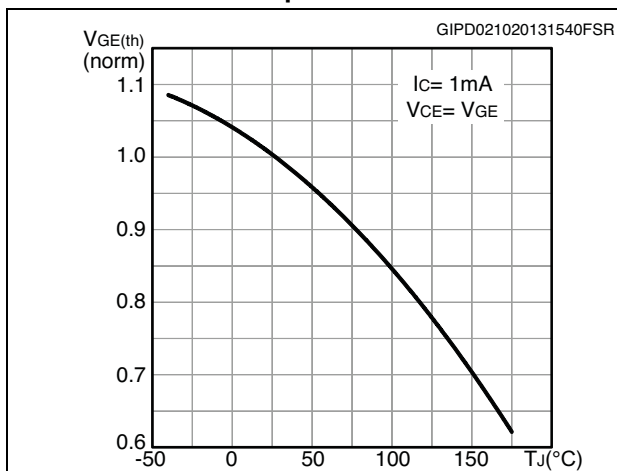

Figure 13. Normalized V(BR)CES vs. junction temperature

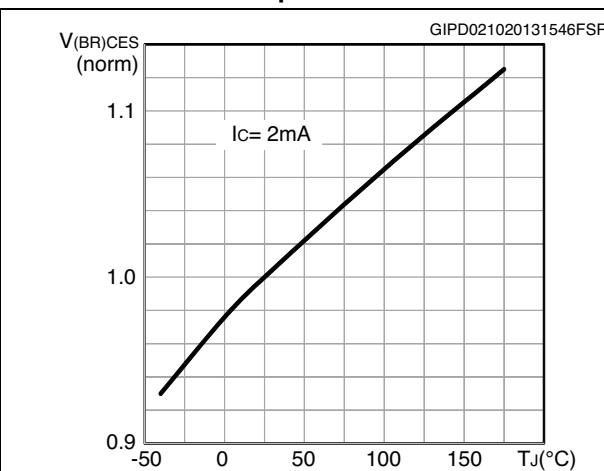

Figure 14. Capacitance variation

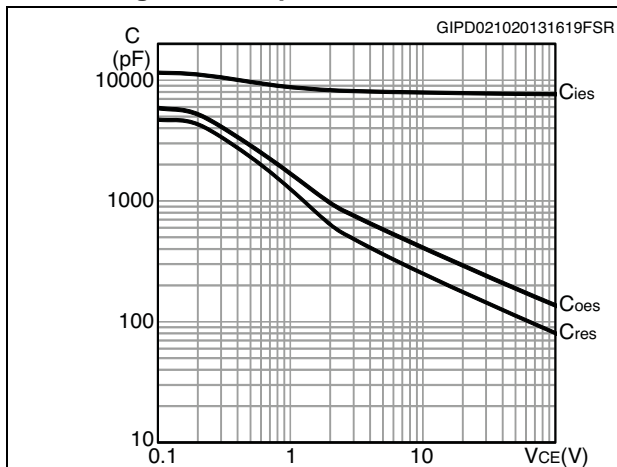

Figure 15. Gate charge vs. gate-emitter voltage

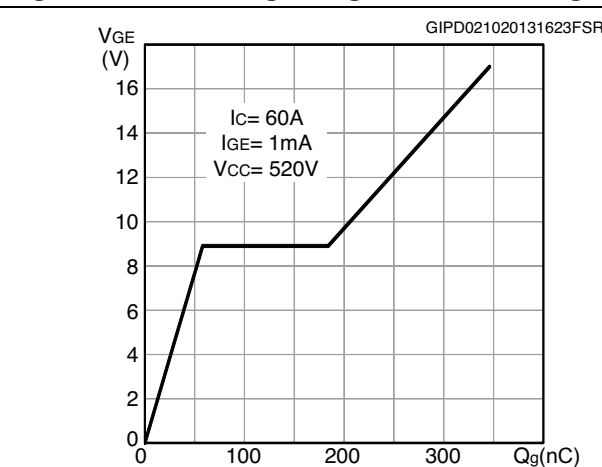

Figure 16. Switching-off loss vs collector current

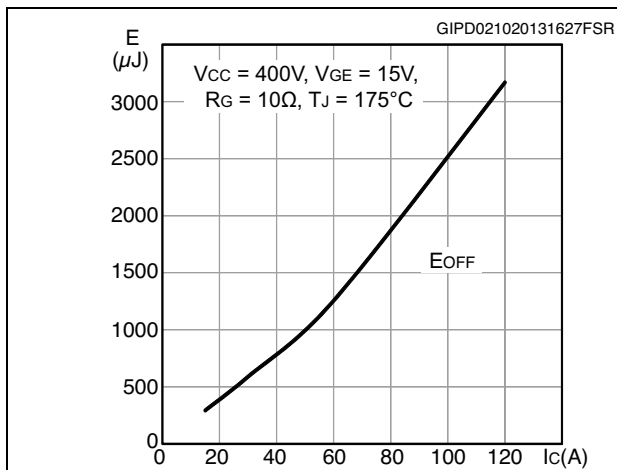

Figure 17. Switching-off loss vs gate resistance

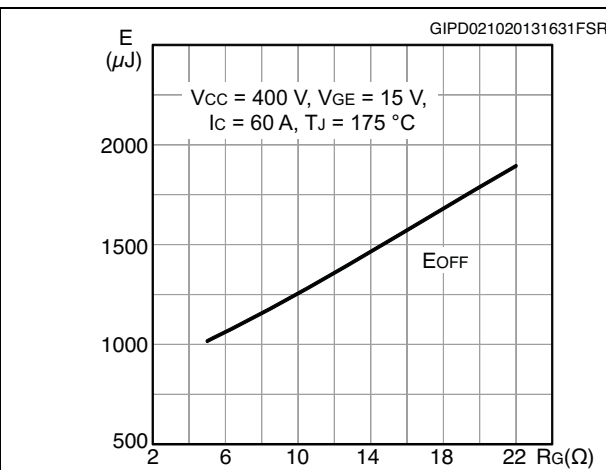

Figure 18. Switching-off loss vs temperature

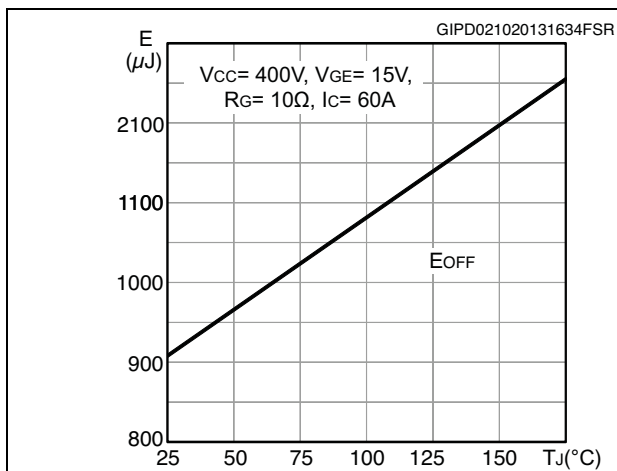

Figure 19. Switching-off loss vs collector-emitter voltage

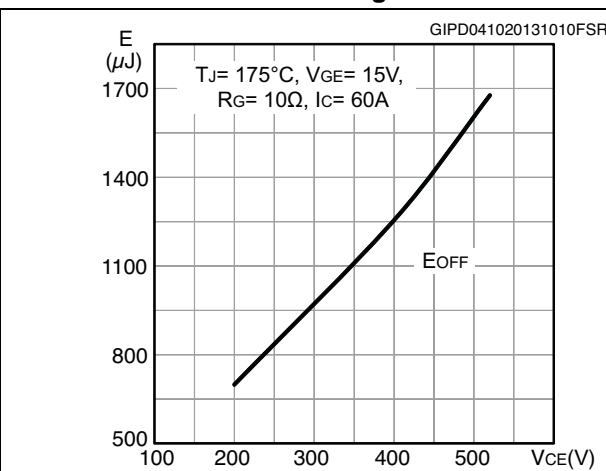



Figure 20. Switching times vs. collector current    Figure 21. Switching times vs. gate resistance

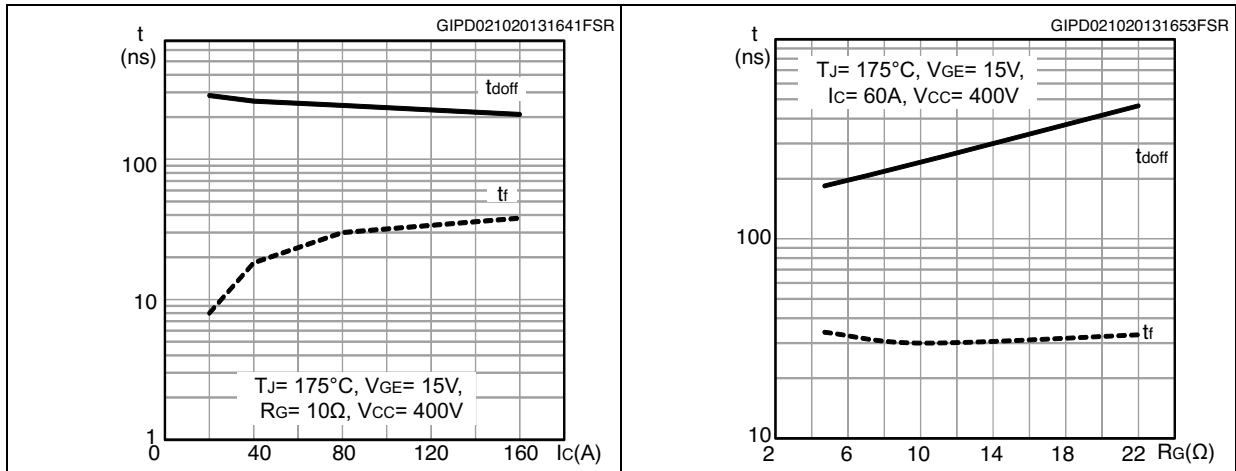

Figure 22. Switching-off losses vs. capacitive load

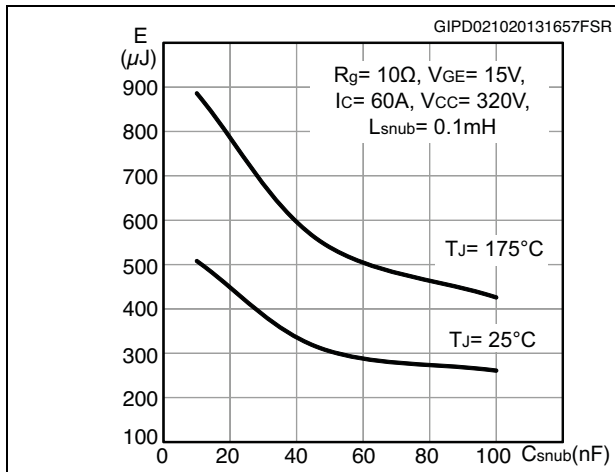

Figure 23. Thermal impedance for IGBT

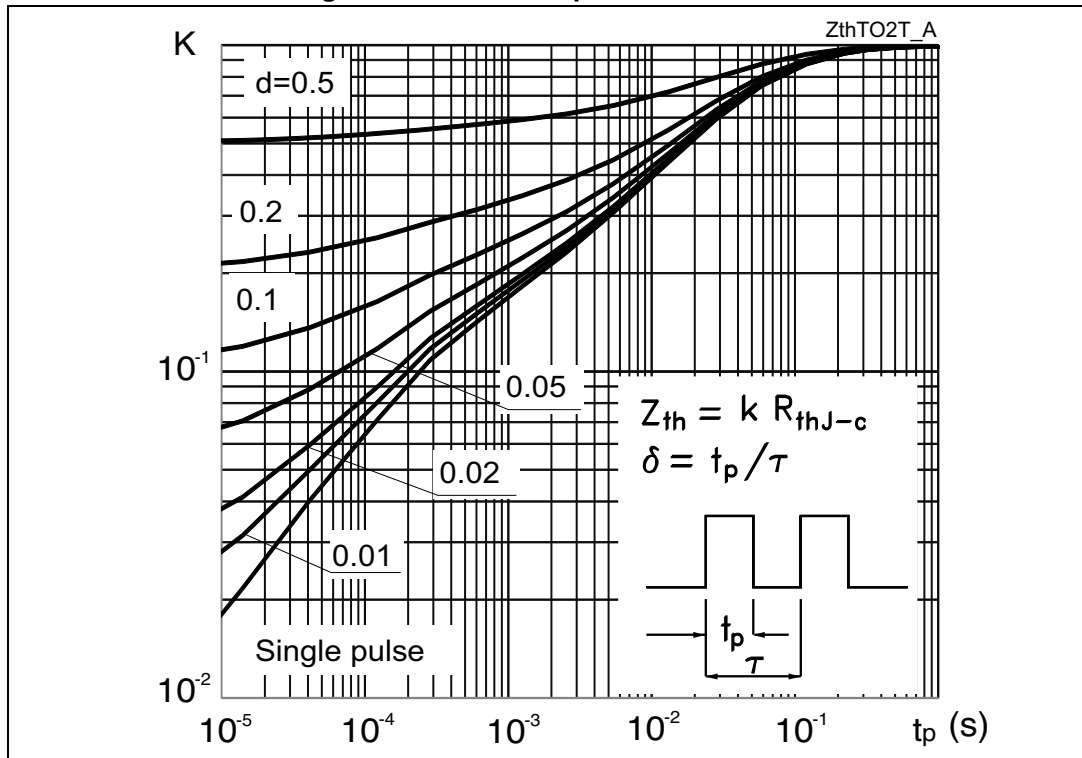
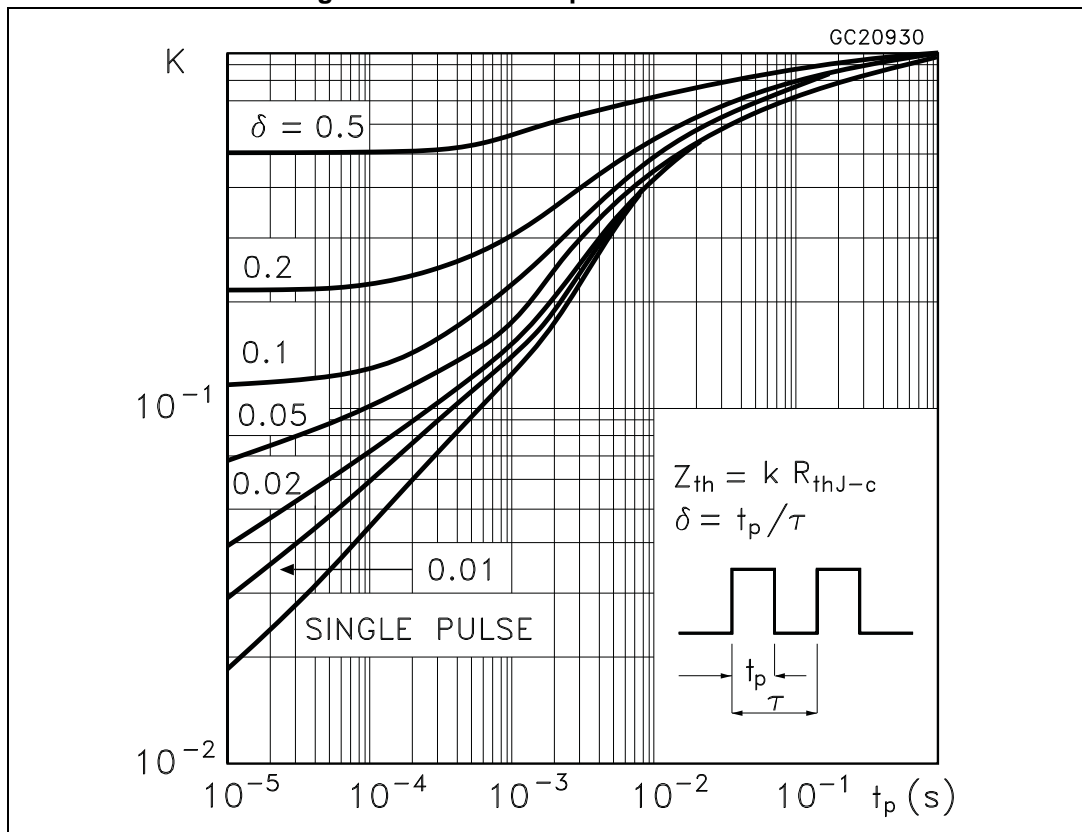

Figure 24. Thermal impedance for diode



### 3 Test circuits

Figure 25. Test circuit for inductive load switching



Figure 26. Test circuit for capacitive load switching

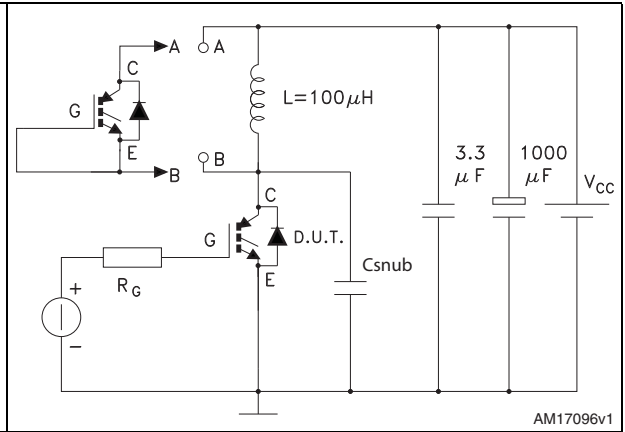

Figure 27. Gate charge test circuit



Figure 28. Switching waveform

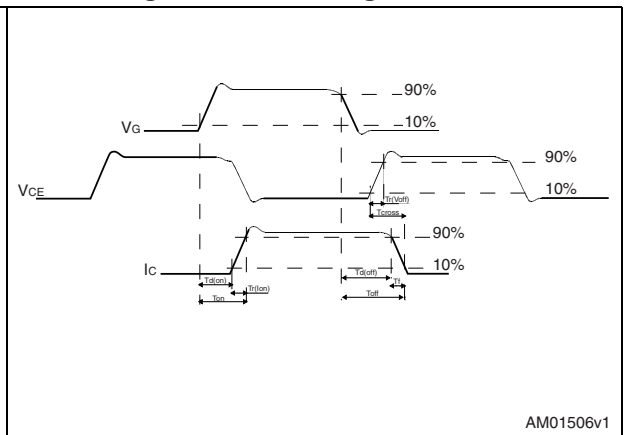
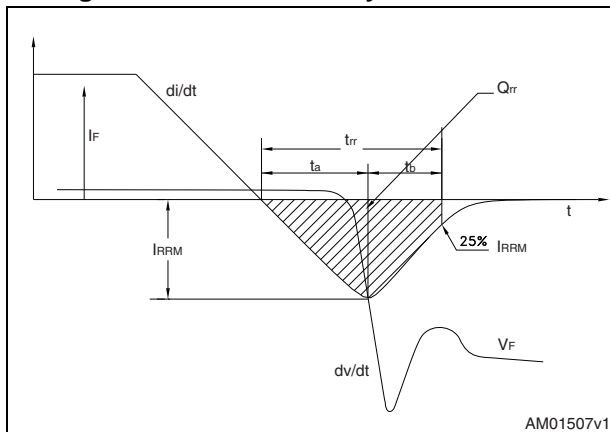

Figure 29. Diode recovery time waveform



## 4 Package mechanical data

In order to meet environmental requirements, ST offers these devices in different grades of ECOPACK<sup>®</sup> packages, depending on their level of environmental compliance. ECOPACK<sup>®</sup> specifications, grade definitions and product status are available at: [www.st.com](http://www.st.com). ECOPACK is an ST trademark.

Figure 30. TO-247 drawing

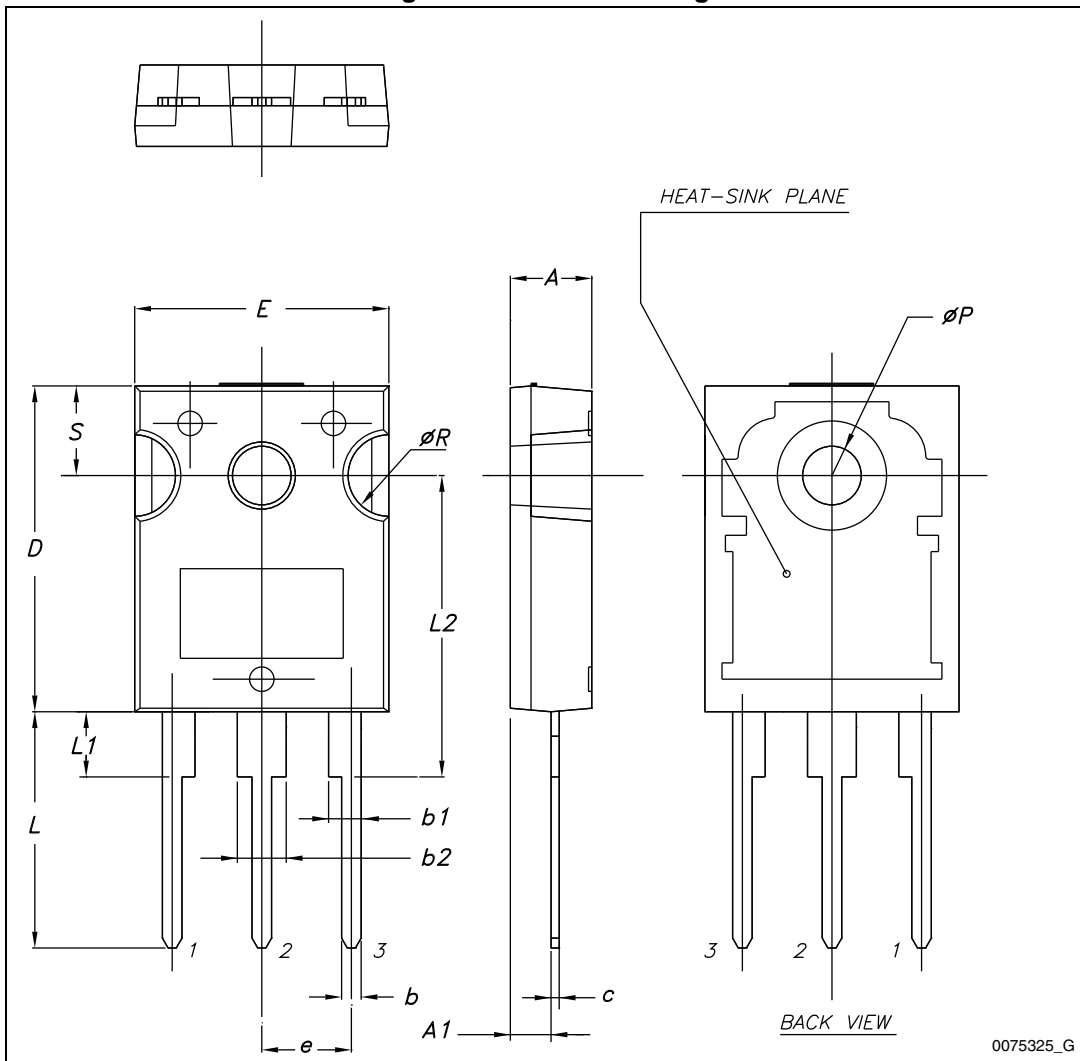

0075325\_G

Table 8. TO-247 mechanical data

Dim.	mm.		
	Min.	Typ.	Max.
A	4.85		5.15
A1	2.20		2.60
b	1.0		1.40
b1	2.0		2.40
b2	3.0		3.40
c	0.40		0.80
D	19.85		20.15
E	15.45		15.75
e	5.30	5.45	5.60
L	14.20		14.80
L1	3.70		4.30
L2		18.50	
ØP	3.55		3.65
ØR	4.50		5.50
S	5.30	5.50	5.70

Figure 31. TO-3P drawing

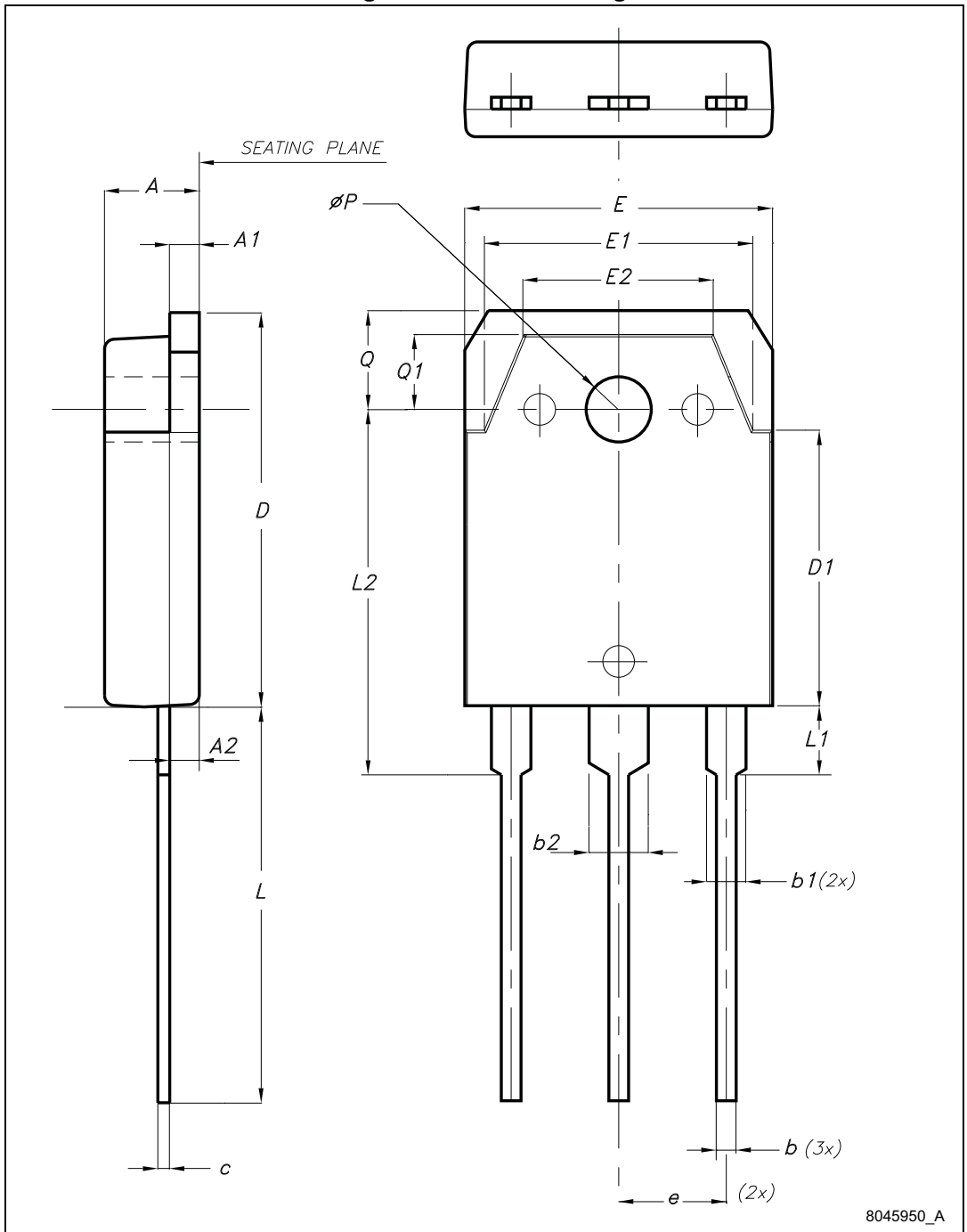

Table 9. TO-3P mechanical data

Dim.	mm		
	Min.	Typ.	Max.
A	4.60		5
A1	1.45	1.50	1.65
A2	1.20	1.40	1.60
b	0.80	1	1.20
b1	1.80		2.20
b2	2.80		3.20
c	0.55	0.60	0.75
D	19.70	19.90	20.10
D1		13.90	
E	15.40		15.80
E1		13.60	
E2		9.60	
e	5.15	5.45	5.75
L	19.50	20	20.50
L1		3.50	
L2	18.20	18.40	18.60
øP	3.10		3.30
Q		5	
Q1		3.80	

## 5 Revision history

Table 10. Document revision history

Date	Revision	Changes
10-Apr-2013	1	Initial release.
04-Oct-2013	2	Document status changed from preliminary to production data. Added <a href="#">Section 2.1: Electrical characteristics (curves)</a> . Minor text changes.
24-Feb-2014	3	Updated title and description in cover page.