

Trench gate field-stop, 1200 V, 75 A, high-speed H series IGBT in a Max247 long leads package

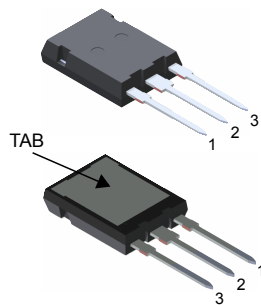

Max247 long leads

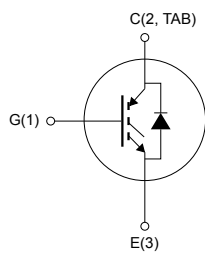

NG1E3C2T



Features

- Maximum junction temperature: $T_J = 175\text{ °C}$
- 5 μs of short-circuit withstand time
- $V_{CE(sat)} = 2.1\text{ V (typ.) @ } I_C = 75\text{ A}$
- Tight parameter distribution
- Positive $V_{CE(sat)}$ temperature coefficient
- Low thermal resistance
- Very fast recovery antiparallel diode

Applications

- UPS
- Solar inverters
- Welding
- PFC

Description

This device is IGBT developed using an advanced proprietary trench gate field-stop structure. This device is part of the H series of IGBTs, which represent an optimum compromise between conduction and switching losses to maximize the efficiency of high switching frequency converters. Moreover, a slightly positive $V_{CE(sat)}$ temperature coefficient and very tight parameter distribution result in safer paralleling operation.

Product status link

[STGYA75H120DF2](#)

Product summary

Order code	STGYA75H120DF2
Marking	G75H120DF2
Package	Max247 long leads
Packing	Tube

1 Electrical ratings

Table 1. Absolute maximum ratings

Symbol	Parameter	Value	Unit
V_{CES}	Collector-emitter voltage ($V_{GE} = 0\text{ V}$)	1200	V
I_C	Continuous collector current at $T_C = 25\text{ °C}$	150 ⁽¹⁾	A
	Continuous collector current at $T_C = 100\text{ °C}$	75	
$I_{CP}^{(2)}$	Pulsed collector current	300	A
V_{GE}	Gate-emitter voltage	± 20	V
I_F	Continuous forward current at $T_C = 25\text{ °C}$	150 ⁽¹⁾	A
	Continuous forward current at $T_C = 100\text{ °C}$	75	
$I_{FP}^{(2)}$	Pulsed forward current	300	A
P_{TOT}	Total power dissipation at $T_C = 25\text{ °C}$	750	W
T_{STG}	Storage temperature range	-55 to 150	°C
T_J	Operating junction temperature range	-55 to 175	°C

1. Current level is limited by bond wires.
2. Pulse width is limited by maximum junction temperature.

Table 2. Thermal data

Symbol	Parameter	Value	Unit
R_{thJC}	Thermal resistance, junction-to-case IGBT	0.2	°C/W
	Thermal resistance, junction-to-case diode	0.48	
R_{thJA}	Thermal resistance, junction-to-ambient	50	°C/W

2 Electrical characteristics

$T_J = 25\text{ °C}$ unless otherwise specified.

Table 3. Static characteristics

Symbol	Parameter	Test conditions	Min.	Typ.	Max.	Unit
$V_{(BR)CES}$	Collector-emitter breakdown voltage	$V_{GE} = 0\text{ V}, I_C = 2\text{ mA}$	1200			V
$V_{CE(sat)}$	Collector-emitter saturation voltage	$V_{GE} = 15\text{ V}, I_C = 75\text{ A}$		2.1	2.6	V
		$V_{GE} = 15\text{ V}, I_C = 75\text{ A}, T_J = 125\text{ °C}$		2.4		
		$V_{GE} = 15\text{ V}, I_C = 75\text{ A}, T_J = 175\text{ °C}$		2.5		
V_F	Forward on-voltage	$I_F = 75\text{ A}$		3.8		V
		$I_F = 75\text{ A}, T_J = 125\text{ °C}$		2.8		
		$I_F = 75\text{ A}, T_J = 175\text{ °C}$		2.6		
$V_{GE(th)}$	Gate threshold voltage	$V_{CE} = V_{GE}, I_C = 2\text{ mA}$	5	6	7	V
I_{CES}	Collector cut-off current	$V_{GE} = 0\text{ V}, V_{CE} = 1200\text{ V}$			25	μA
I_{GES}	Gate-emitter leakage current	$V_{CE} = 0\text{ V}, V_{GE} = \pm 20\text{ V}$			± 250	nA

Table 4. Dynamic characteristics

Symbol	Parameter	Test conditions	Min.	Typ.	Max.	Unit
C_{ies}	Input capacitance	$V_{CE} = 25\text{ V}, f = 1\text{ MHz}, V_{GE} = 0\text{ V}$	-	6300	-	pF
C_{oes}	Output capacitance		-	420	-	pF
C_{res}	Reverse transfer capacitance		-	146	-	pF
Q_g	Total gate charge	$V_{CC} = 960\text{ V}, I_C = 75\text{ A}, V_{GE} = 0\text{ to }15\text{ V}$ (see Figure 29. Gate charge test circuit)	-	313	-	nC
Q_{ge}	Gate-emitter charge		-	50	-	nC
Q_{gc}	Gate-collector charge		-	153	-	nC

Table 5. IGBT switching characteristics (inductive load)

Symbol	Parameter	Test conditions	Min.	Typ.	Max.	Unit
$t_{d(on)}$	Turn-on delay time	$V_{CE} = 600\text{ V}$, $I_C = 75\text{ A}$, $V_{GE} = 15\text{ V}$, $R_G = 10\ \Omega$ (see Figure 28. Test circuit for inductive load switching)		61	-	ns
t_r	Current rise time			34	-	ns
$(di/dt)_{on}$	Turn-on current slope			1810	-	A/ μ s
$t_{d(off)}$	Turn-off delay time			366	-	ns
t_f	Current fall time			40	-	ns
$E_{on}^{(1)}$	Turn-on switching energy			4.3	-	mJ
$E_{off}^{(2)}$	Turn-off switching energy			3.9	-	mJ
E_{ts}	Total switching energy			8.2	-	mJ
$t_{d(on)}$	Turn-on delay time		$V_{CE} = 600\text{ V}$, $I_C = 75\text{ A}$, $V_{GE} = 15\text{ V}$, $R_G = 10\ \Omega$, $T_J = 175\text{ }^\circ\text{C}$ (see Figure 28. Test circuit for inductive load switching)		55	-
t_r	Current rise time			40	-	ns
$(di/dt)_{on}$	Turn-on current slope			1560	-	A/ μ s
$t_{d(off)}$	Turn-off delay time			387	-	ns
t_f	Current fall time			128	-	ns
$E_{on}^{(1)}$	Turn-on switching energy			6	-	mJ
$E_{off}^{(2)}$	Turn-off switching energy			5.2	-	mJ
E_{ts}	Total switching energy			11.2	-	mJ
t_{sc}	Short-circuit withstand time	$V_{CC} \leq 600\text{ V}$, $V_{GE} = 15\text{ V}$, $T_{Jstart} \leq 150\text{ }^\circ\text{C}$		5		-

1. Including the reverse recovery of the diode.

2. Including the tail of the collector current.

Table 6. Diode switching characteristics (inductive load)

Symbol	Parameter	Test conditions	Min.	Typ.	Max.	Unit	
t_{rr}	Reverse recovery time	$I_F = 75\text{ A}$, $V_R = 600\text{ V}$, $V_{GE} = 15\text{ V}$, $di/dt = 1550\text{ A}/\mu\text{s}$ (see Figure 28. Test circuit for inductive load switching)	-	356	-	ns	
Q_{rr}	Reverse recovery charge			-	2.6	-	μ C
I_{rrm}	Reverse recovery current			-	26.9	-	A
dI_{rr}/dt	Peak rate of fall of reverse recovery current during t_b			-	1360	-	A/ μ s
E_{rr}	Reverse recovery energy			-	0.98	-	mJ
t_{rr}	Reverse recovery time		$I_F = 75\text{ A}$, $V_R = 600\text{ V}$, $V_{GE} = 15\text{ V}$, $di/dt = 1550\text{ A}/\mu\text{s}$, $T_J = 175\text{ }^\circ\text{C}$ (see Figure 28. Test circuit for inductive load switching)	-	595	-	ns
Q_{rr}	Reverse recovery charge			-	6.9	-	μ C
I_{rrm}	Reverse recovery current			-	37	-	A
dI_{rr}/dt	Peak rate of fall of reverse recovery current during t_b			-	505	-	A/ μ s
E_{rr}	Reverse recovery energy			-	2.85	-	mJ

2.1 Electrical characteristics (curves)

Figure 1. Power dissipation vs case temperature

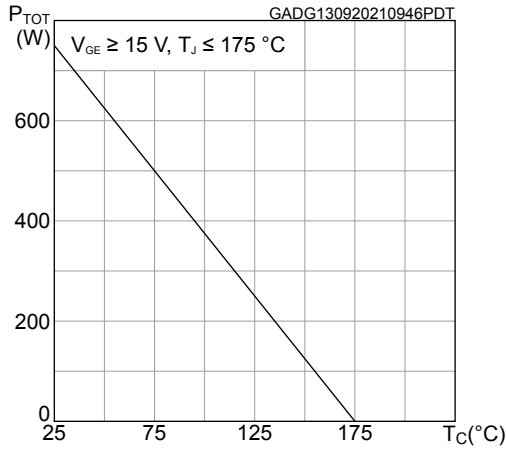

Figure 2. Collector current vs case temperature

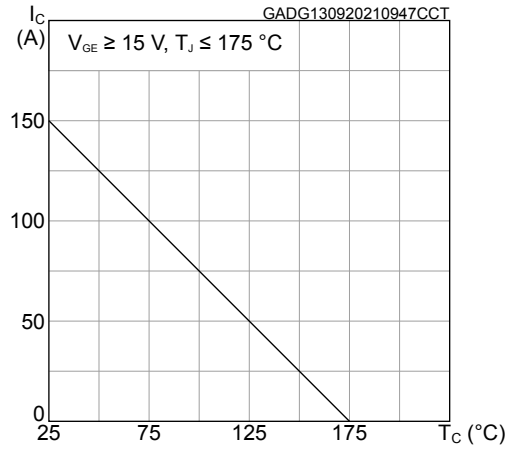

Figure 3. Output characteristics (T_J = 25 °C)

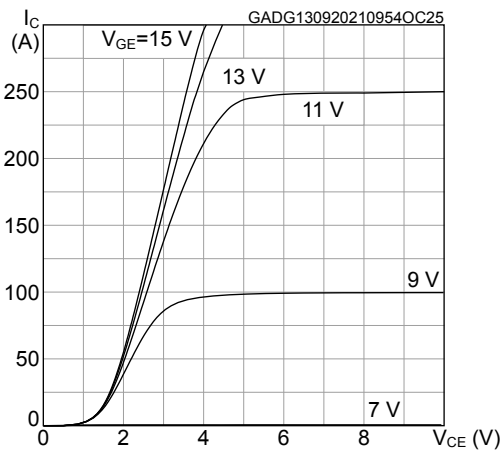

Figure 4. Output characteristics (T_J = 175 °C)

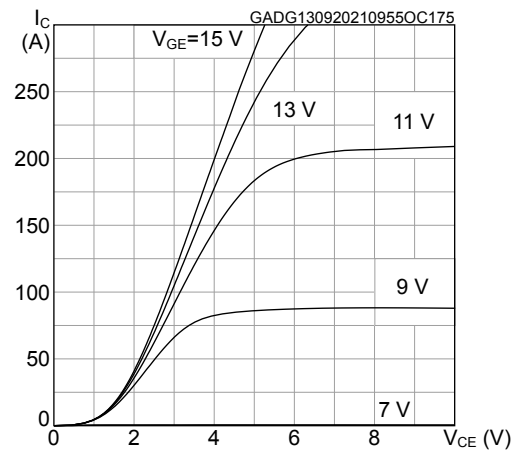

Figure 5. V_{CE(sat)} vs junction temperature

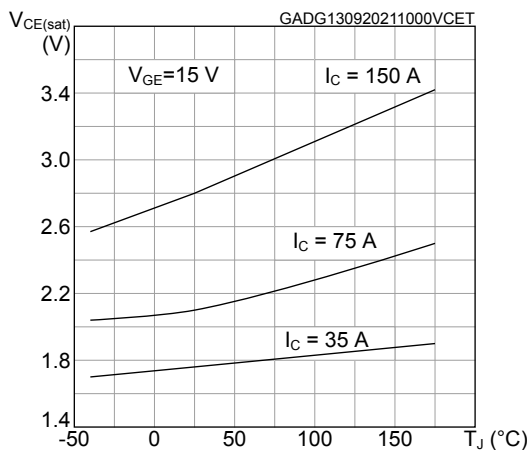

Figure 6. V_{CE(sat)} vs collector current

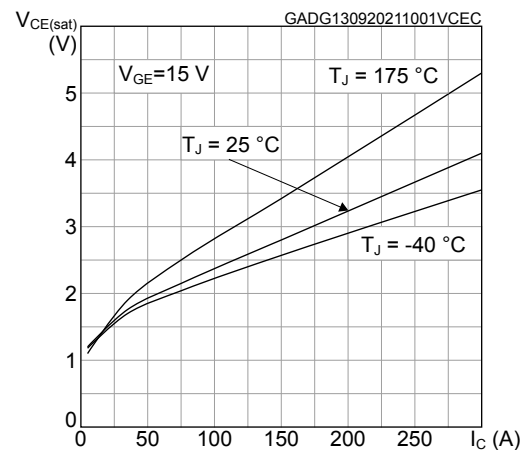

Figure 7. Collector current vs switching frequency

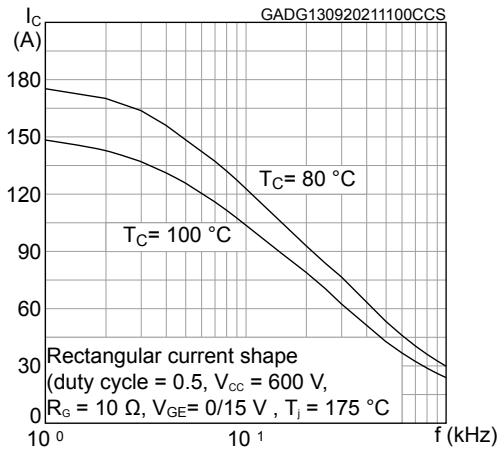

Figure 8. Safe operating area

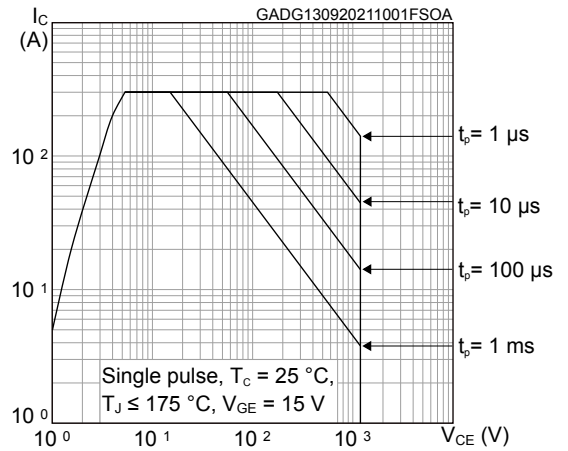

Figure 9. Transfer characteristics

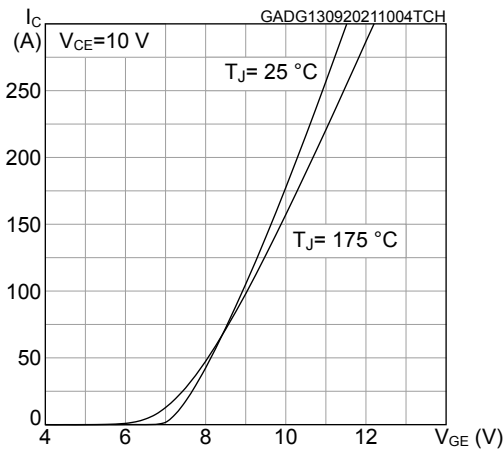

Figure 10. Diode VF vs forward current

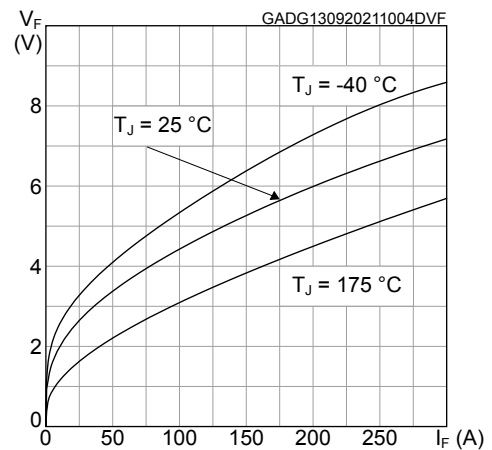

Figure 11. Normalized VGE(th) vs junction temperature

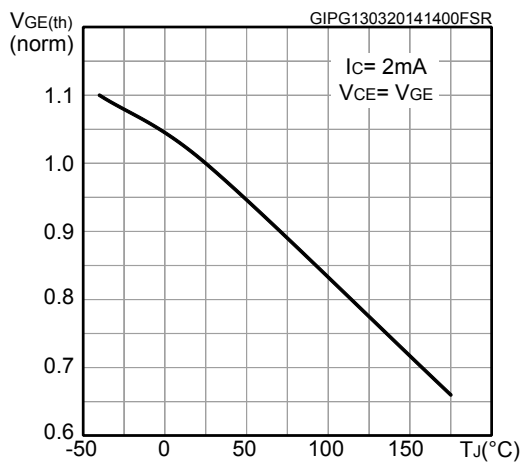

Figure 12. Normalized V(BR)CES vs junction temperature

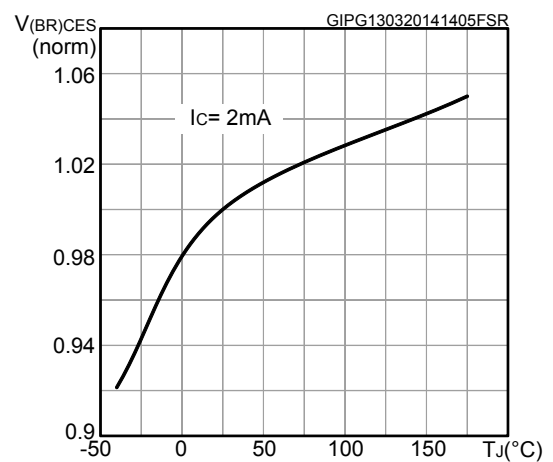

Figure 13. Capacitance variations

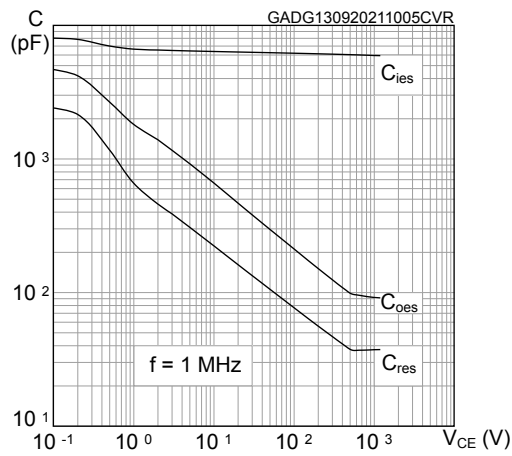

Figure 14. Gate charge vs gate-emitter voltage

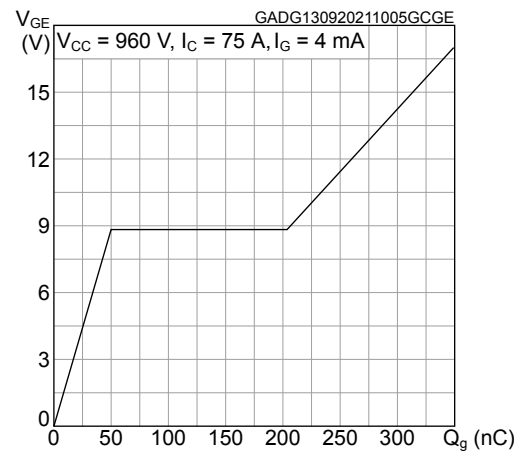

Figure 15. Switching energy vs collector current

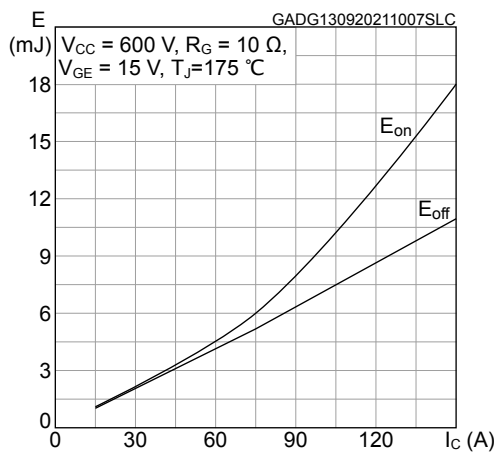

Figure 16. Switching energy vs gate resistance

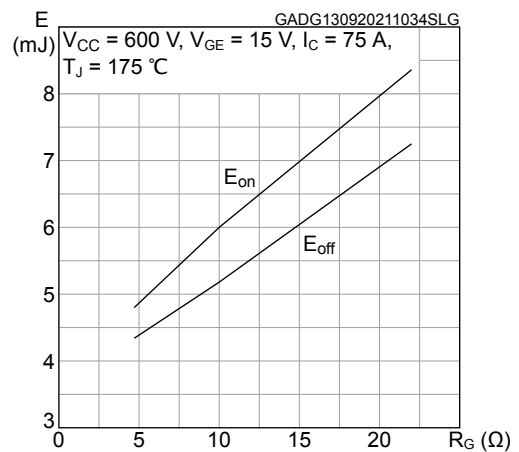

Figure 17. Switching energy vs junction temperature

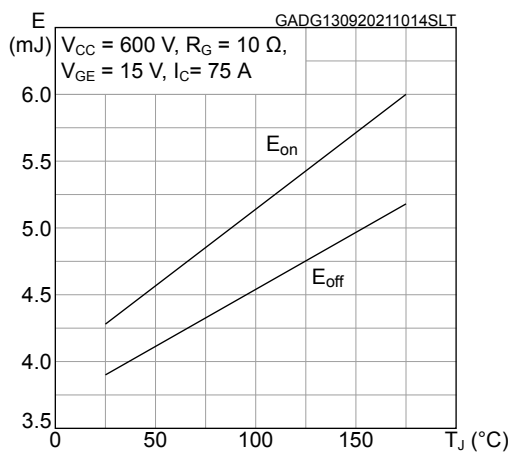

Figure 18. Switching energy vs collector emitter voltage

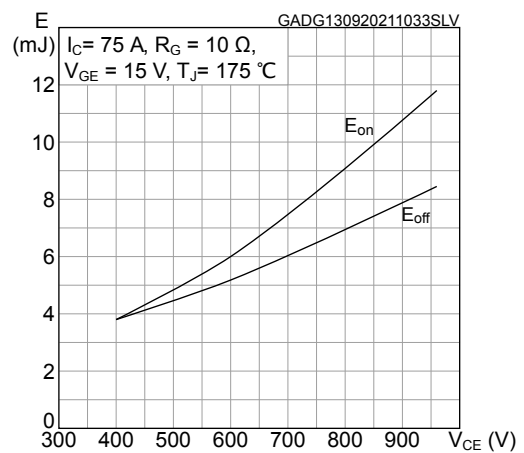

Figure 19. Switching times vs collector current

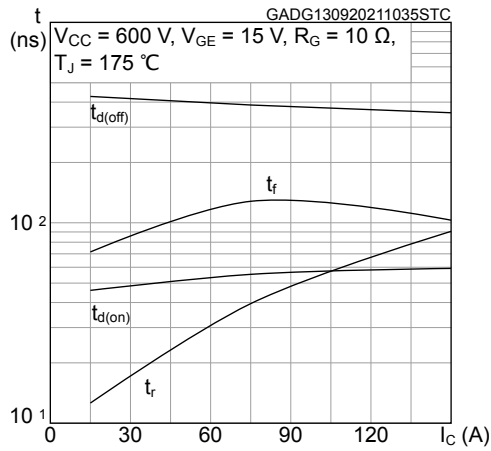

Figure 20. Switching times vs gate resistance

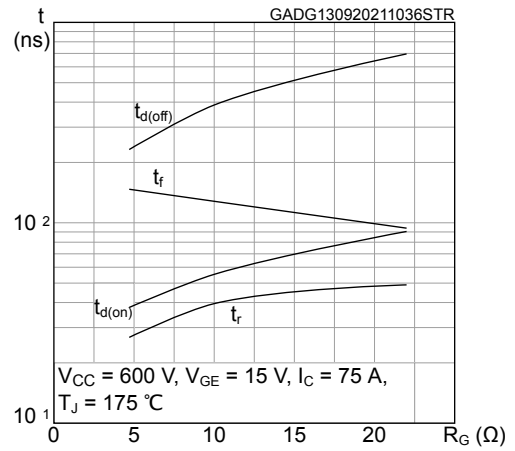

Figure 21. Reverse recovery current vs diode current slope

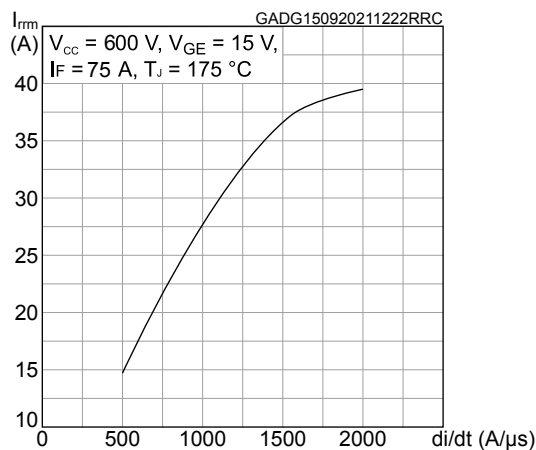

Figure 22. Reverse recovery time vs diode current slope

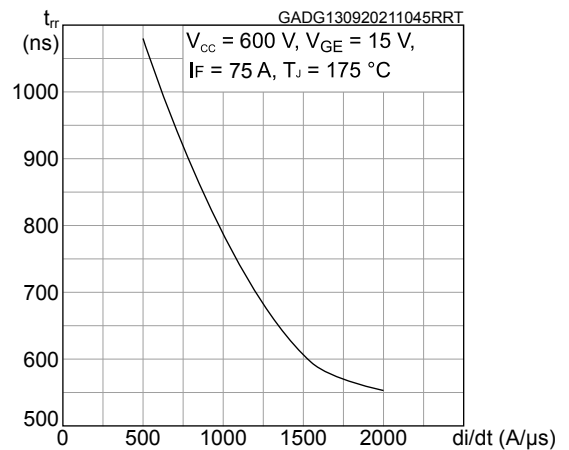

Figure 23. Reverse recovery charge vs diode current slope

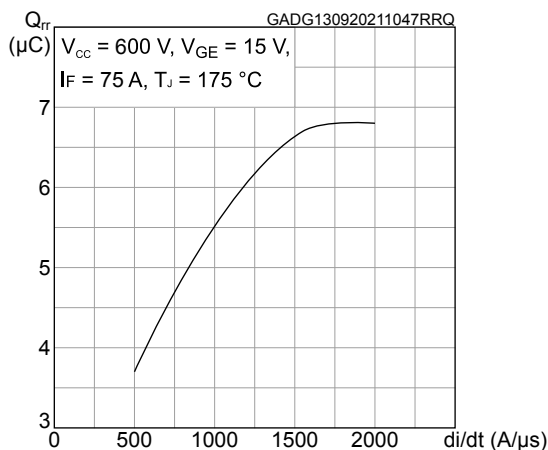

Figure 24. Reverse recovery energy vs diode current slope

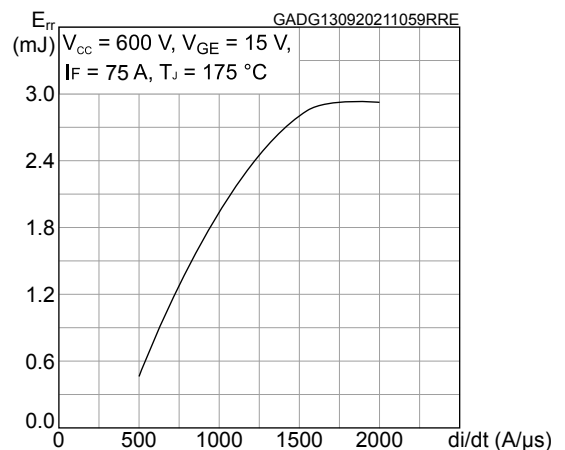

Figure 25. Thermal impedance for IGBT

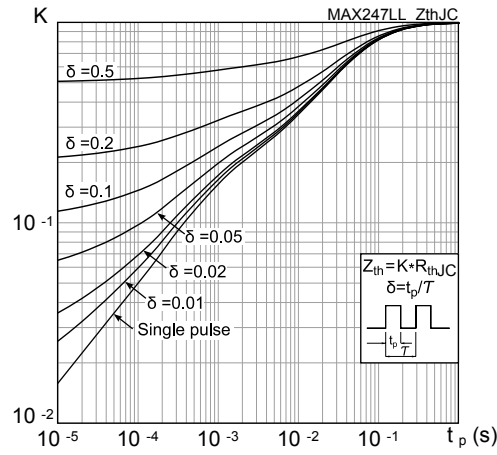
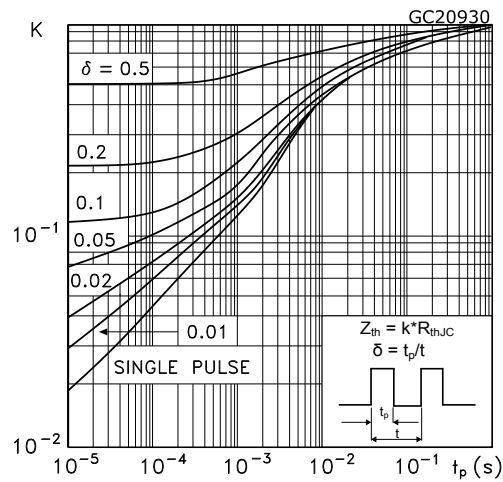
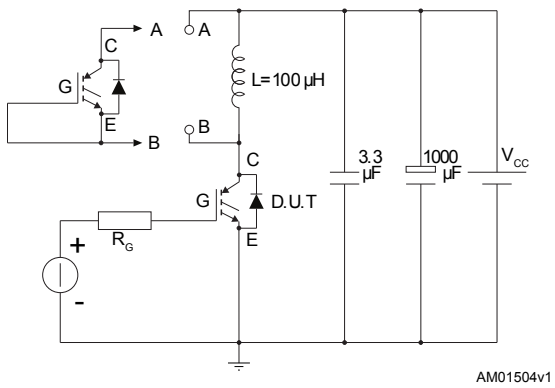

Figure 26. Thermal impedance for diode



3 Test circuits

Figure 27. Test circuit for inductive load switching



AM01504v1

Figure 28. Gate charge test circuit

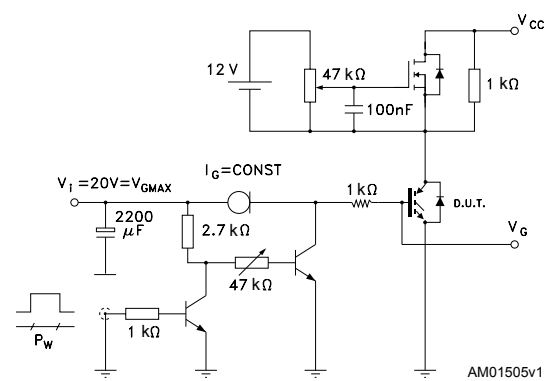

AM01505v1

Figure 29. Switching waveform

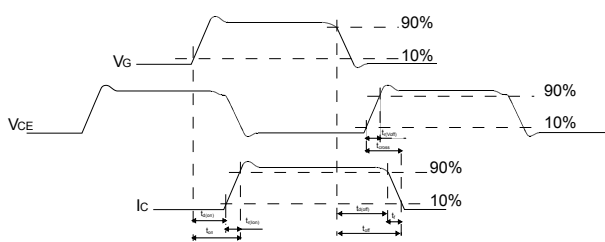

AM01506v1

Figure 30. Diode reverse recovery waveform

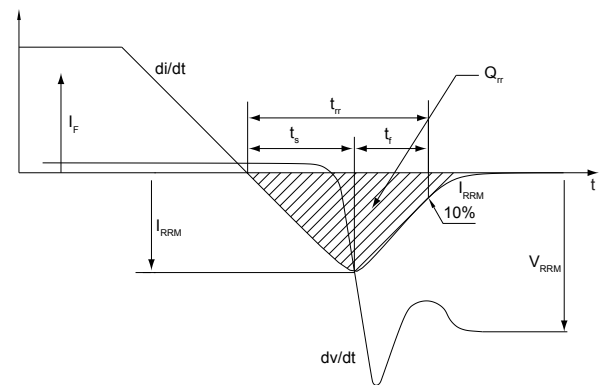

GADG180720171418SA

4 Package information

In order to meet environmental requirements, ST offers these devices in different grades of **ECOPACK** packages, depending on their level of environmental compliance. ECOPACK specifications, grade definitions and product status are available at: www.st.com. ECOPACK is an ST trademark.

4.1 Max247 long leads package information

Figure 31. Max247 long leads package outline

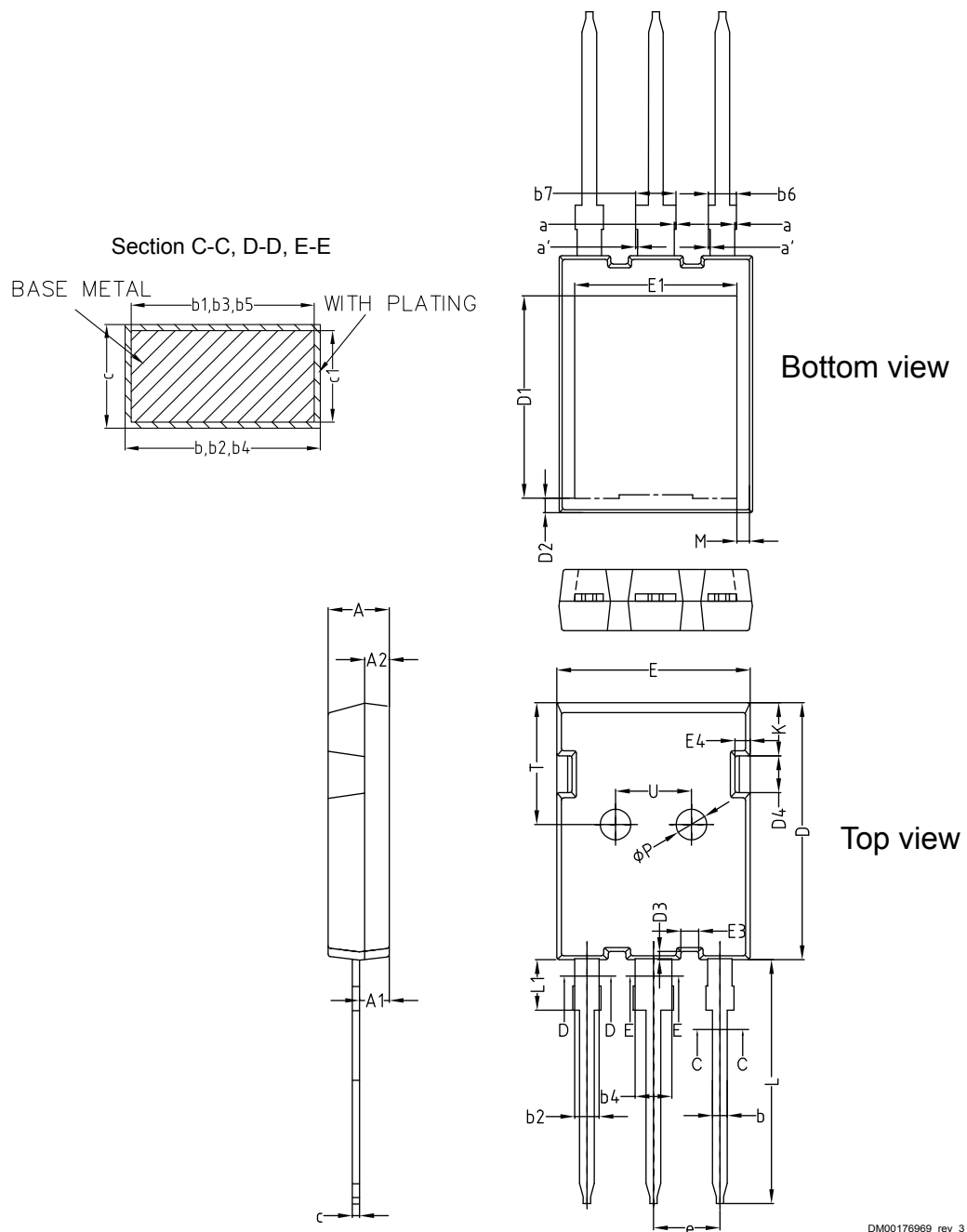

DM00176969_rev_3

Table 7. Max247 long leads package mechanical data

Dim.	mm		
	Min.	Typ.	Max.
A	4.90	5.00	5.10
A1	2.31	2.41	2.51
A2	1.90	2.00	2.10
a	0		0.15
a'	0		0.15
b	1.16		1.26
b1	1.15	1.20	1.22
b2	1.96		2.06
b3	1.95	2.00	2.02
b4	2.96		3.06
b5	2.95	3.00	3.02
b6			2.25
b7			3.25
c	0.59		0.66
c1	0.58	0.60	0.62
D	20.90	21.00	21.10
D1	16.25	16.55	16.85
D2	1.05	1.17	1.35
D3	0.58	0.68	0.78
D4	2.90	3.00	3.10
E	15.70	15.80	15.90
E1	13.10	13.26	13.50
E3	1.35	1.45	1.55
E4	1.14	1.24	1.34
e	5.34	5.44	5.54
K	4.25	4.35	4.45
L	19.80	19.92	20.10
L1	3.90		4.30
M	0.70		1.30
P	2.40	2.50	2.60
T	9.80		10.20
U	6.00		6.40

Revision history

Table 8. Document revision history

Date	Revision	Changes
08-Sep-2021	1	First release.
13-Oct-2021	2	Updated Table 3. Static characteristics.

Contents

1	Electrical ratings	2
2	Electrical characteristics	3
2.1	Electrical characteristics (curves)	5
3	Test circuits	10
4	Package information	11
4.1	Max247 long leads package information	11
	Revision history	13