

# STN202XXXUXXX

## TVS Diode array ESD suppressor

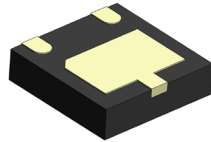

### Product features

- Low leakage current
- Low clamping voltage
- Solid-state silicon-avalanche technology
- Meets moisture sensitivity level (MSL) 3
- Molding compound flammability rating: UL 94V-0
- Termination finish: Tin plating

### Applications

- Power lines
- DC Fast charging
- Microprocessors based equipment
- Notebooks, desktops, and servers
- Cellular handsets and accessories
- Portable electronics and peripherals

### Environmental compliance and general specifications

- IEC61000-4-2 (ESD)
  - Up to  $\pm 30$  kV (air)
  - Up to  $\pm 30$  kV (contact)
- IEC61000-4-5 (Lightning) Up to 240 A (8/20  $\mu$ s)



### Ordering part number

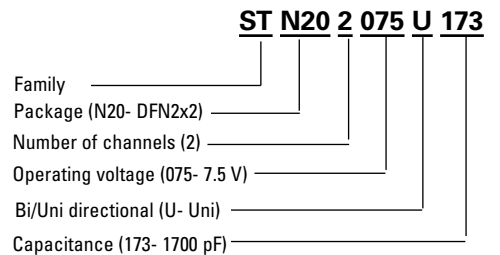

### Pin out/functional diagram

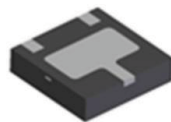

DFN2x2-3L



Circuit Diagram



Pin Configuration

### Absolute maximum ratings

(+25 °C, RH=45%-75%, unless otherwise noted)

Parameter	Symbol	Value				Unit
		STN202075U173	STN202120U952	STN202150U952	STN202240U752	
Peak pulse power dissipation on 8/20 μs waveform	$P_{pp}$	5000	4500	4500	6000	W
ESD per IEC 61000-4-2 (Air)	$V_{ESD}$	+/-30	+/-30	+/-30	+/-30	kV
ESD per IEC 61000-4-2 (Contact)		+/-30	+/-30	+/-30	+/-30	
Lead soldering temperature	$T_L$	+260 (10 seconds)	+260 (10 seconds)	+260 (10 seconds)	+260 (10 seconds)	°C
Operating junction temperature range	$T_J$	-55 to +125	-55 to +125	-55 to +125	-55 to +125	°C
Storage temperature range	$T_{STG}$	-55 to +150	-55 to +150	-55 to +150	-55 to +150	°C

### Electrical characteristics

(+25 °C)

#### STN202075U173

Parameter	Test condition	Minimum	Typical	Maximum	Symbol (Units)
Reverse working voltage	-	-	-	7.5	$V_{RWM}$ (V)
Reverse breakdown voltage	$I_T = 1$ mA	8	9	10	$V_{BR}$ (V)
Reverse leakage current	$V_{RWM} = 7.5$ V	-	-	1	$I_R$ (μA)
Clamping voltage	$I_{pp} = 50$ A, $t_p = 8/20$ μs	-	13	15.5	$V_C$ (V)
	$I_{pp} = 100$ A, $t_p = 8/20$ μs	-	15.5	18.5	$V_C$ (V)
	$I_{pp} = 240$ A, $t_p = 8/20$ μs	-	21	25	$V_C$ (V)
Junction capacitance	$V_{RWM} = 0$ V, $f = 1$ MHz	1600	1700	2200	$C_J$ (pF)

#### STN202120U952

Parameter	Test condition	Minimum	Typical	Maximum	Symbol (Units)
Reverse working voltage	-	-	-	12	$V_{RWM}$ (V)
Reverse breakdown voltage	$I_T = 1$ mA	13	14.5	16	$V_{BR}$ (V)
Reverse leakage current	$V_{RWM} = 12$ V	-	-	1	$I_R$ (μA)
Clamping voltage	$I_{pp} = 50$ A, $t_p = 8/20$ μs	-	-	22	$V_C$ (V)
	$I_{pp} = 100$ A, $t_p = 8/20$ μs	-	-	25	$V_C$ (V)
	$I_{pp} = 180$ A, $t_p = 8/20$ μs	-	-	32	$V_C$ (V)
Junction capacitance	$V_{RWM} = 0$ V, $f = 1$ MHz	900	950	1200	$C_J$ (pF)

#### STN202150U952

Parameter	Test condition	Minimum	Typical	Maximum	Symbol (Units)
Reverse working voltage	-	-	-	15	$V_{RWM}$ (V)
Reverse breakdown voltage	$I_T = 1$ mA	16	17.5	19	$V_{BR}$ (V)
Reverse leakage current	$V_{RWM} = 15$ V	-	-	1	$I_R$ (μA)
Clamping voltage	$I_{pp} = 50$ A, $t_p = 8/20$ μs	-	22	25	$V_C$ (V)
	$I_{pp} = 100$ A, $t_p = 8/20$ μs	-	25	27	$V_C$ (V)
	$I_{pp} = 150$ A, $t_p = 8/20$ μs	-	29	35	$V_C$ (V)
Junction capacitance	$V_{RWM} = 0$ V, $f = 1$ MHz	-	950	1200	$C_J$ (pF)

**STN202240U752**

Parameter	Test condition	Minimum	Typical	Maximum	Symbol (Units)
Reverse working voltage	-	-	-	24	$V_{RWM}$ (V)
Reverse breakdown voltage	$I_T = 1$ mA	26	27	30	$V_{BR}$ (V)
Reverse leakage current	$V_{RWM} = 24$ V	-	-	1	$I_R$ ( $\mu$ A)
Clamping voltage	$I_{PP} = 50$ A, $t_p = 8/20$ $\mu$ s	-	45	50	$V_C$ (V)
	$I_{PP} = 120$ A, $t_p = 8/20$ $\mu$ s	-	52	60	$V_C$ (V)
Junction capacitance	$V_{RWM} = 0$ V, $f = 1$ MHz	-	750	-	$C_J$ (pF)

**Mechanical parameters, pad layout- mm**

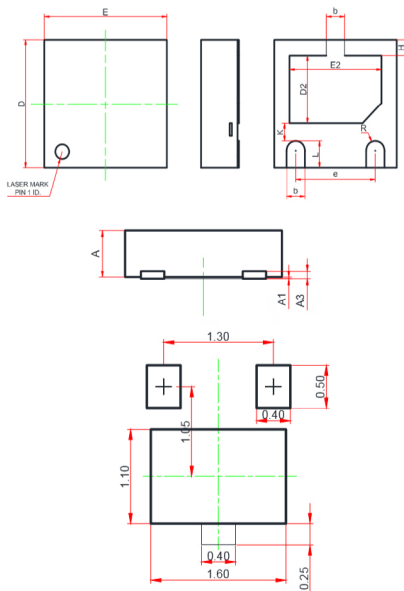

Land pattern

Dimension	Minimum	Typical	Maximum
A	0.51	0.55	0.60
A1	0.00	0.02	0.05
A3		0.15 REF	
b	0.25	0.30	0.35
D	1.90	2.00	2.10
E	1.90	2.00	2.10
D2	0.85	1.00	1.10
E2	1.35	1.50	1.60
e	1.20	1.30	1.40
H	0.20	0.25	0.30
K	0.20	0.30	0.40
L	0.35	0.40	0.45
R	0.15	-	-

**Part marking**

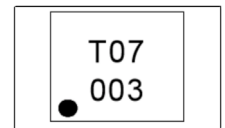

(STN202075U173)

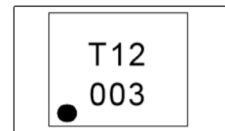

(STN202120U952)

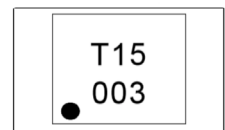

(STN202150U952)

**Packaging information (mm)**

Drawing not to scale.

Supplied in tape and reel packaging, 3,000 parts per 7" diameter reel (EIA-481 compliant)

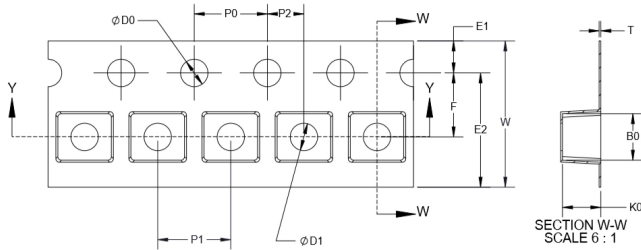

W	8.00
F	3.50
E1	1.75
E2	N/A
P0	4.00
P1	4.00
P2	2.00
ØD0	1.55
ØD1	N/A
A0	2.20
B0	2.20
K0	0.70
T	N/A

Cavity Shape For Reference Only

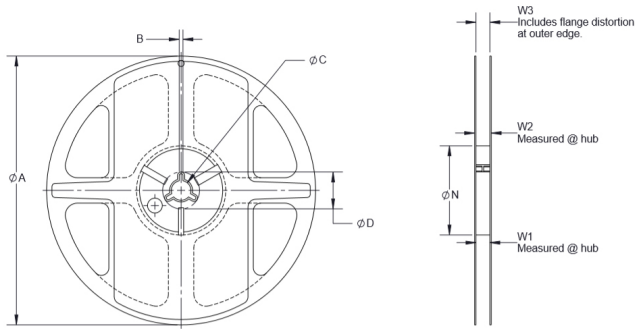

A	178.00
B	N/A
C	13.00
D	N/A
N	54.40
W1	9.50
W2	12.30
W3	N/A

Shape & Appearance For Reference Only

**Ratings and V-I characteristic curves** (+25 °C unless otherwise noted)

**V- I curve characteristics (Uni-directional)**

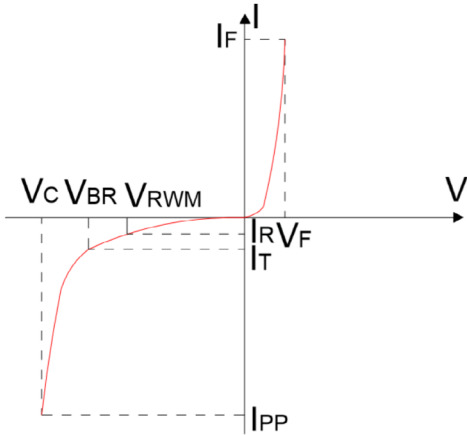

**Pulse waveform (8/20  $\mu$ s)**

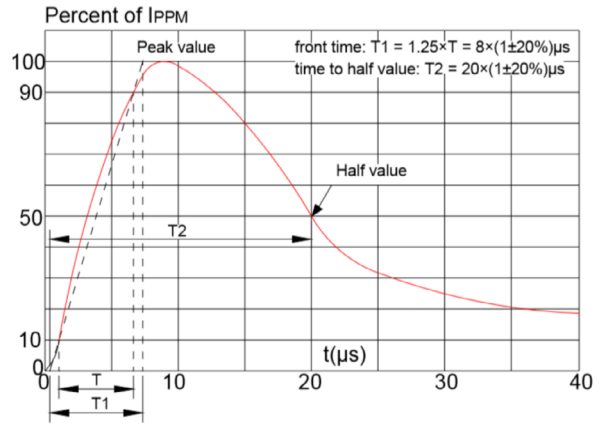

**Pulse derating curve**

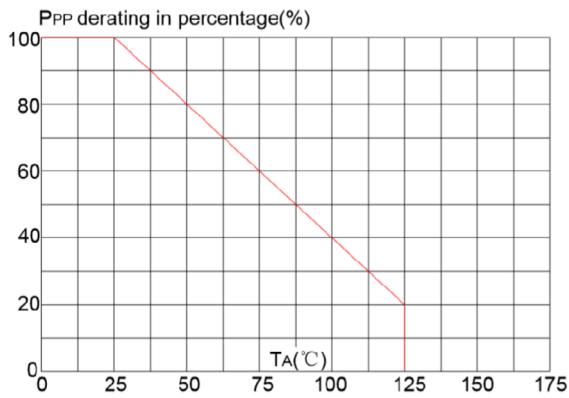

**ESD waveform**

