

4 x 50 W MOSFET quad bridge power amplifier

Datasheet - production data

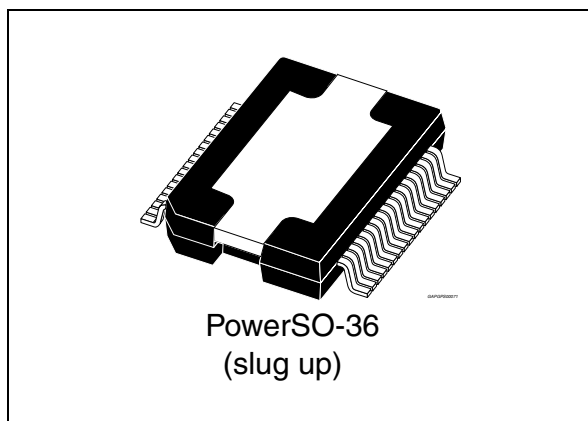

- Overrating chip temperature with soft thermal limiter
- Output DC offset detection
- Load dump
- Fortuitous open GND
- Reversed battery
- ESD

Description

STPA008ZS is a breakthrough MOSFET technology class AB audio power amplifier designed for high power car radio. The fully complementary P-Channel/N-Channel output structure allows a rail to rail output voltage swing which, combined with high output current and minimized saturation losses sets new power references in the car-radio field, with unparalleled distortion performances.

STPA008ZS can operate down to 6V and this makes the IC compliant to the most recent OEM specifications for low voltage operation (so called 'start-stop' battery profile during engine stop), helping car manufacturers to reduce the overall emissions and thus to contribute to environment protection.

Features



- AEC-Q100 qualified
- High output power capability:
 - 4 x 50 W/4 Ω Max.
 - 4 x 28 W/4 Ω @ 14.4 V, 1 kHz, 10 %
 - 4 x 72 W/2 Ω Max.
- MOSFET output power stage
- 2 Ω driving capability
- Capable to operate down to 6 V (suitable for start-stop car operation)
- Excellent GSM noise immunity
- Hi-Fi class distortion
- Low output noise
- High immunity to RF noise injection
- Standby function
- Mute function
- Automute at min. supply voltage detection
- Low external component count
- Internally fixed gain (26 dB)
- Protections:
 - Output short circuit to GND, to V_s , across the load
 - Very inductive loads

Table 1. Device summary

Order code	Package	Packing
STPA008-ZST	PowerSO36	Tape & Reel

Contents

1	Overview	5
1.1	Block diagram and application circuit	5
2	Pin description	7
2.1	Pin connection	7
2.2	Pin descriptions	7
3	Electrical specifications	9
3.1	Absolute maximum ratings	9
3.2	Thermal data	9
3.3	Electrical characteristics	10
3.4	Typical curves of the main electrical parameters	12
4	General information	15
4.1	Operation	15
4.2	Battery variations	15
4.2.1	Low voltage operation	15
4.2.2	Cranks	16
4.2.3	Advanced battery management (hybrid vehicles)	17
4.3	Protections	18
4.3.1	Short circuits and open load operation	18
4.3.2	Over-voltage and load dump protection	18
4.3.3	Thermal protection	18
4.4	Warnings	19
4.4.1	DC offset detection (OD pin)	19
4.4.2	Clipping detection and diagnostics (CD-DIAG pin)	19
4.5	Heat sink definition	20
5	Package information	21
5.1	PowerSO-36 (slug up) package information	21
5.2	PowerSO-36 marking information	23
6	Revision history	24

List of tables

Table 1.	Device summary	1
Table 2.	Pin description	7
Table 3.	Absolute maximum ratings	9
Table 4.	Thermal data	9
Table 5.	Electrical characteristics	10
Table 6.	PowerSO-36 (slug up) package mechanical data	22
Table 7.	Document revision history	24

List of figures

Figure 1.	Block diagram	5
Figure 2.	Application circuit	6
Figure 3.	Pin connection (top view)	7
Figure 4.	Quiescent current vs. supply voltage	12
Figure 5.	Output power vs. supply voltage (4 Ω)	12
Figure 6.	Output power vs. supply voltage (2 Ω)	12
Figure 7.	Distortion vs. output power (4 Ω)	12
Figure 8.	Distortion vs. output power (2 Ω)	12
Figure 9.	Distortion vs. frequency (4 Ω)	12
Figure 10.	Distortion vs. frequency (2 Ω)	13
Figure 11.	Distortion vs. output power (4 Ω , $V_S = 6$ V)	13
Figure 12.	Distortion vs. output power (2 Ω , $V_S = 6$ V)	13
Figure 13.	Supply voltage rejection vs. frequency	13
Figure 14.	Crosstalk vs. frequency	13
Figure 15.	Total power dissipation & efficiency vs. P_o (4 Ω , Sine)	13
Figure 16.	Power dissipation vs. average Output Power (4 Ω , audio program simulation)	14
Figure 17.	Power dissipation vs. average Output Power (2 Ω , audio program simulation)	14
Figure 18.	ITU R-ARM frequency response, weighting filter for transient pop.	14
Figure 19.	SVR charge diagram	15
Figure 20.	Battery cranking curve example 1	16
Figure 21.	Battery cranking curve example 2	16
Figure 22.	Upwards fast battery transitions diagram	17
Figure 23.	Load dump protection diagram	18
Figure 24.	Thermal protection diagram	18
Figure 25.	Audio section waveforms	19
Figure 26.	PowerSO-36 (slug up) package outline	21
Figure 27.	PowerSO-36 marking information.	23

1 Overview

STPA008ZS is a complementary quad audio power amplifier. It embeds four independent amplifiers working in class AB, a standby and a mute pin, an offset detector and a clipping detector and diagnostics output. The amplifier is fully operational down to a battery voltage of 6 V, without producing pop noise and continuing to play during battery transitions.

STPA008ZS can drive 2 ohm loads and it has a very high immunity to disturb without need of external components or compensation. It is protected against any kind of short or open circuit, over-voltage and over-temperature.

1.1 Block diagram and application circuit

Figure 1. Block diagram

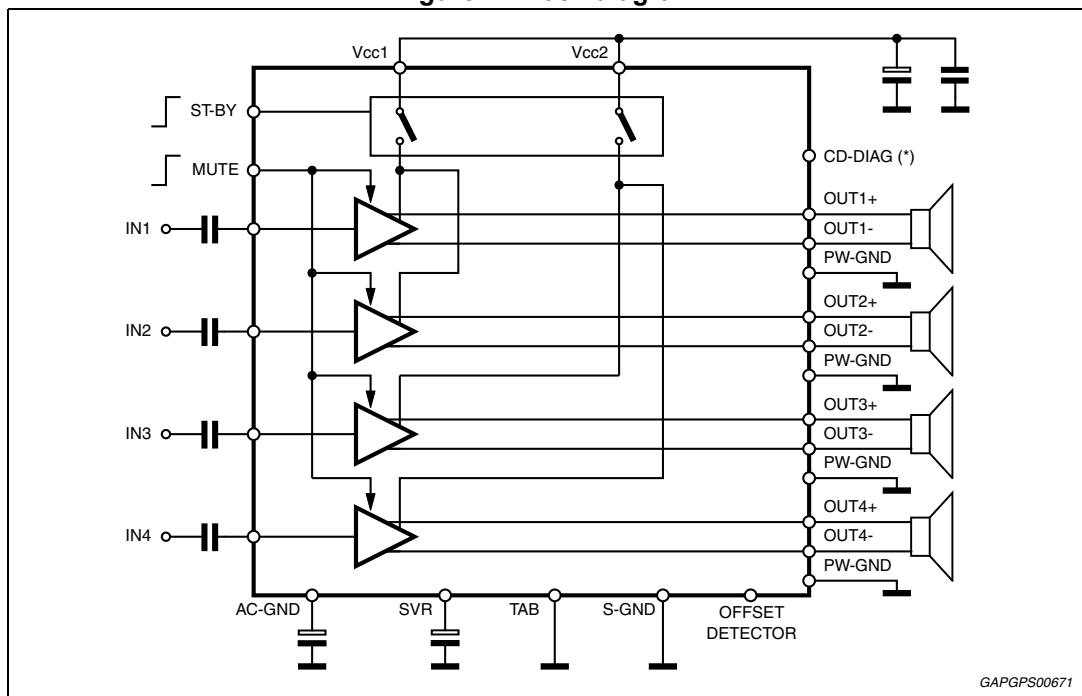
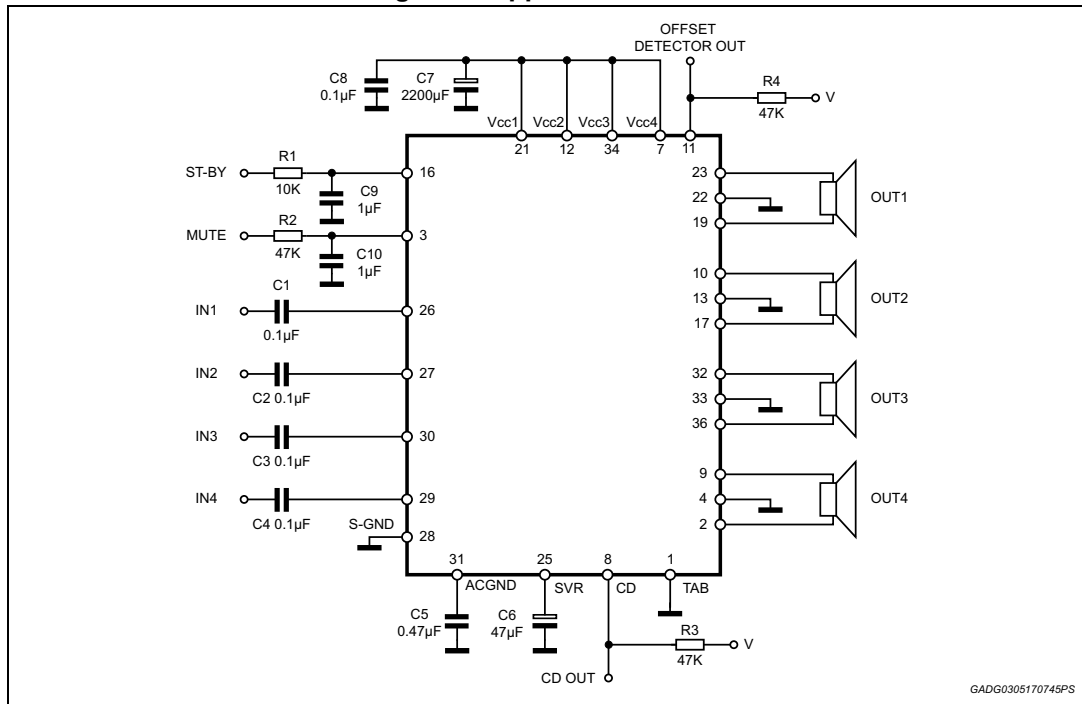

Figure 2. Application circuit



GADG0305170745PS

2 Pin description

2.1 Pin connection

Figure 3. Pin connection (top view)

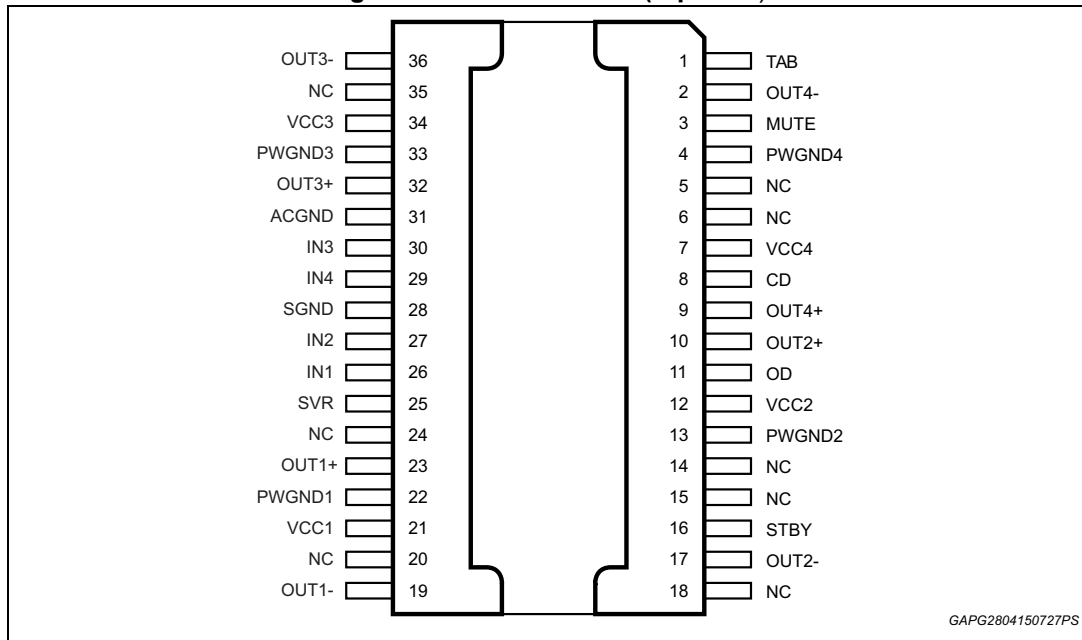

2.2 Pin descriptions

Table 2. Pin description

Pin number	Pin name	Description
1	TAB	-
2	OUT4-	Channel 4, negative output
3	MUTE	Mute pin
4	PWGND4	Channel 4, output power ground
5	NC	-
6	NC	-
7	VCC4	Supply voltage
8	CD	clipping detector
9	OUT4+	Channel 4, positive output
10	OUT2+	Channel 2, positive output
11	OD	Offset detector output
12	VCC2	Supply voltage
13	PWGND2	Channel 2, output power ground

Table 2. Pin description (continued)

Pin number	Pin name	Description
14	NC	-
15	NC	-
16	ST-BY	Stand-by
17	OUT2-	Channel 2, negative output
18	NC	-
19	OUT1-	Channel 1, negative output
20	NC	-
21	VCC1	Supply voltage
22	PWGND1	Channel 1, output power ground
23	OUT1+	Channel 1, positive output
24	NC	-
25	SVR	Supply voltage rejection pin
26	IN1	Channel 1, input
27	IN2	Channel 2, input
28	SGND	Signal ground
29	IN4	Channel 4, input
30	IN3	Channel 3, input
31	ACGND	AC ground
32	OUT3+	Channel 3, positive output
33	PWGND3	Channel 3, output power ground
34	VCC3	Supply voltage
35	NC	-
36	OUT3-	Channel 3, negative output

3 Electrical specifications

3.1 Absolute maximum ratings

Table 3. Absolute maximum ratings

Symbol	Parameter	Value	Unit
V_S	Operating supply voltage	18	V
$V_{S(DC)}$	DC supply voltage	28	V
$V_{S(pk)}$	Peak supply voltage (for $t = 50$ ms)	50	V
I_O	Output peak current Non repetitive ($t = 100$ μ s)	10	A
	Repetitive (duty cycle 10 % at $f = 10$ Hz)	9	A
P_{tot}	Power dissipation $T_{case} = 70$ °C	85	W
T_{amb}	Ambient operating temperature ⁽¹⁾	-40 to 105	°C
T_j	Junction temperature	150	°C
T_{stg}	Storage temperature	-55 to 150	°C
GND_{max}	Ground pins voltage	-0.3 to 0.3	V
$V_{in max}$	Input pin max voltage	-0.3 to 8	V
$V_{SB max}$	ST-BY pin max voltage	-0.3 to $V_{S(pk)}$	V
$V_{mute max}$	Mute pin max voltage	-0.3 to 6	V
ESD_{HBM}	ESD protection HBM ⁽²⁾	± 2000	V
ESD_{CDM}	ESD protection CDM ⁽²⁾ standard	± 500	V
	ESD protection CDM ⁽²⁾ corner	± 750	V

1. A suitable heatsink/dissipation system should be used to keep T_j inside the specified limits.

2. Definition according to the international standard.

3.2 Thermal data

Table 4. Thermal data

Symbol	Parameter	Value	Unit
$R_{th j-case}$	Thermal resistance junction-to-case	Max 1	°C/W

3.3 Electrical characteristics

Refer to the test and application diagram, $V_S = 14.4\text{ V}$; $R_L = 4\ \Omega$; $R_g = 600\ \Omega$; $f = 1\text{ kHz}$; $T_{\text{amb}} = 25\text{ }^\circ\text{C}$; unless otherwise specified.

Table 5. Electrical characteristics

Symbol	Parameter	Test condition	Min.	Typ.	Max.	Unit
General characteristics						
V_S	Supply voltage range	-	6	-	18	V
I_{q1}	Quiescent current	$R_L = \infty$	100	190	280	mA
V_{OS}	Output offset voltage	Play mode	-90	-	+90	mV
		Mute mode	-70	-	+70	mV
dV_{OS}	During standby ON/OFF output transient voltage	ITU R-ARM weighted (see Figure 18)	-7.5	-	+7.5	mV
	During mute ON/OFF output transient voltage		-7.5	-	+7.5	mV
R_i	Input impedance	-	45	55	70	k Ω
I_{SB}	Standby current consumption	$V_{\text{St-by}} = 1\text{ V}$	-	-	2	μA
		$V_{\text{St-by}} = 0$	-	-	1	μA
Audio performances						
P_o	Output power	THD = 10 %	26	29	-	W
		THD = 1 %	20	23	-	W
		THD = 10 %, 2 Ω	45	50	-	W
		THD = 1 %, 2 Ω	37	40	-	W
$P_{o\text{ max.}}$	Max. output power	Square wave input (2 Vrms)				
		$R_L = 4\ \Omega$	42	45	-	W
		$R_L = 2\ \Omega$	71	77	-	W
		$V_S = 15.2\text{ V}$; $R_L = 4\ \Omega$	47	50	-	W
THD	Distortion	$P_o = 4\text{ W}$, 30kHz LPF	-	0.01	0.02	%
G_v	Voltage gain	-	25	26	27	dB
dG_v	Channel gain unbalance	-	-0.5	-	+0.5	dB
e_{No}	Output Noise	"A" Weighted	-	40	-	μV
		Bw = 20 Hz to 20 kHz	-	50	70	μV
SVR	Supply voltage rejection	$f = 100\text{ kHz}$; $V_r = 1\text{ Vrms}$, play mode	60	70	-	dB
f_{ch}	High cut-off frequency	$P_o = 0.5\text{ W}$	100	300	-	kHz
C_T	Cross talk	$f = 1\text{ kHz}$ $P_o = 4\text{ W}$	65	75	-	dB
		$f = 10\text{ kHz}$ $P_o = 4\text{ W}$	50	60	-	dB
A_M	Mute attenuation	$P_{\text{Oref}} = 4\text{ W}$	90	100	-	dB

Table 5. Electrical characteristics (continued)

Symbol	Parameter	Test condition	Min.	Typ.	Max.	Unit
Control pin characteristics						
I_{pin5}	Standby pin current	$V_{St-by} = 1\text{ V to }2.2\text{ V}$	-	-	0.5	μA
$V_{SB\ out}$	Standby out threshold voltage	(Amp: ON)	2.2	-	-	V
$V_{SB\ in}$	Standby in threshold voltage	(Amp: OFF)	-	-	1	V
$V_{M\ out}$	Mute out threshold voltage	(Amp: Play)	2.2	-	-	V
$V_{M\ in}$	Mute in threshold voltage	(Amp: Mute)	-	-	0.8	V
$V_{AM\ in}$	V_S automute threshold	Attenuation = 6 dB; $P_{Oref} = 4\text{ W}$	4.5	5	5.5	V
I_{pin23}	Muting pin current	$V_{MUTE} = 0.8\text{ V}$ (Sourced current)	5	8	12	μA
Offset detector						
V_{OFF}	Detected differential output offset	-	± 1.3	± 2	± 2.7	V
V_{OFF_SAT}	Off detector saturation voltage	$V_o > V_{OFF\ max}$, $I_{off\ Det} = 1\text{ mA}$ $0\text{ V} < V_{off\ Det} < 18\text{ V}$	-	0.1	0.2	V
V_{OFF_LK}	Off detector leakage current	$V_o < \pm 1\text{ V}$	-	0	15	μA
Clipping detector						
CD_{LK}	Clip detector high leakage current	CD Off	-	0	1	μA
CD_{SAT}	Clip detector saturation voltage	CD On; $I_{CD} = 1\text{ mA}$	-	0.1	0.2	V
CD_{THD}	Clip detector THD level	-	-	2	3	%

Note: [Table 5](#) electrical characteristics are defined at $T_{amb} = 25\text{ }^\circ\text{C}$ as already specified in the same table.

Product release is including 3T characterization data collection (cold, room, hot), while full production testing is performed at 2T:

- $T_{amb} = T_{room}$ for EWS
- $T_{amb} = T_{hot}$ for Final Test

3.4 Typical curves of the main electrical parameters

Figure 4. Quiescent current vs. supply voltage

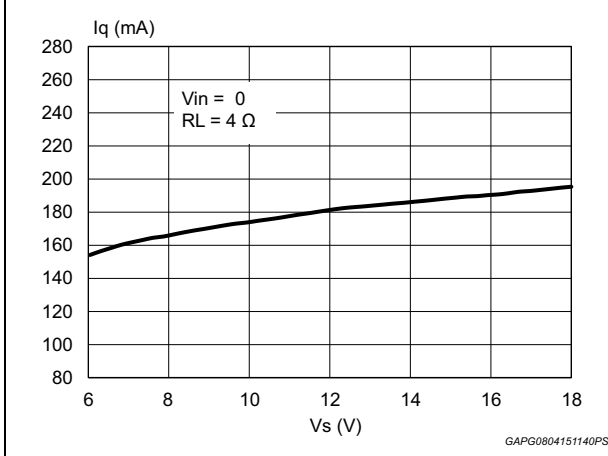

Figure 5. Output power vs. supply voltage (4 Ohm)

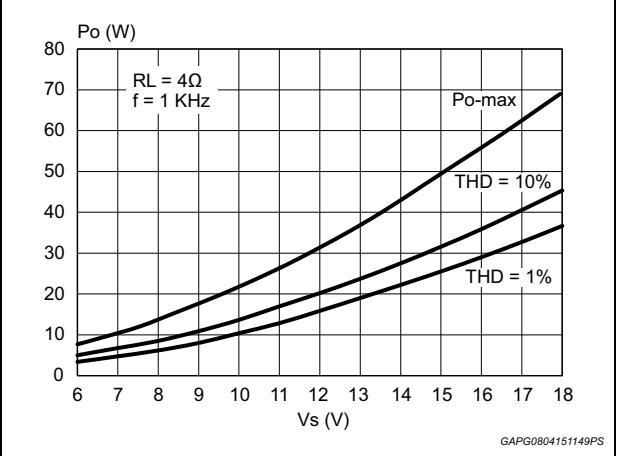

Figure 6. Output power vs. supply voltage (2 Ohm)

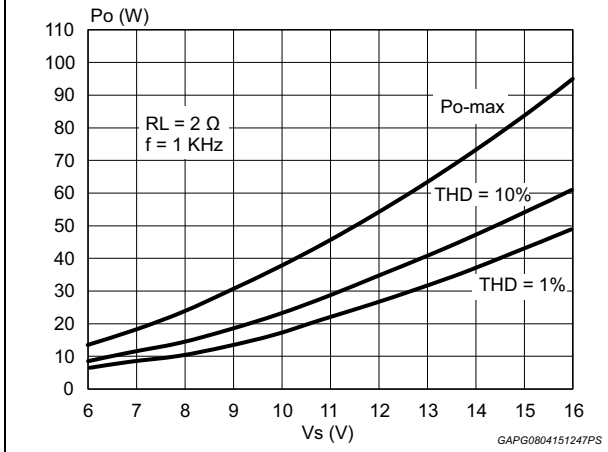

Figure 7. Distortion vs. output power (4 Ohm)

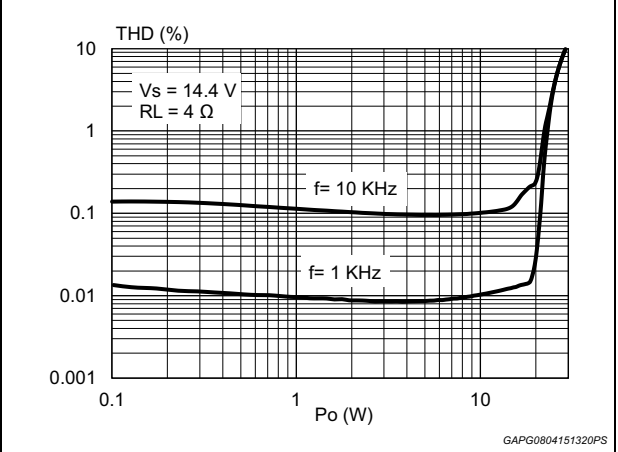

Figure 8. Distortion vs. output power (2 Ohm)

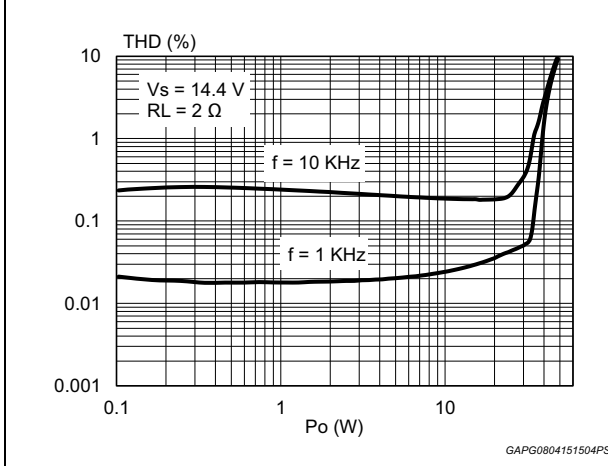

Figure 9. Distortion vs. frequency (4 Ohm)

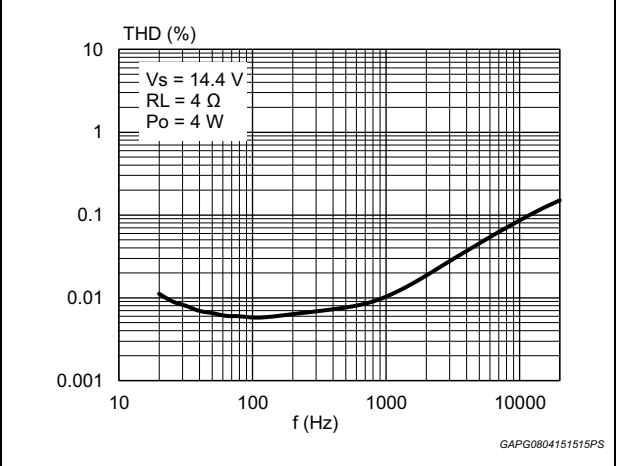

Figure 10. Distortion vs. frequency (2 Ω)

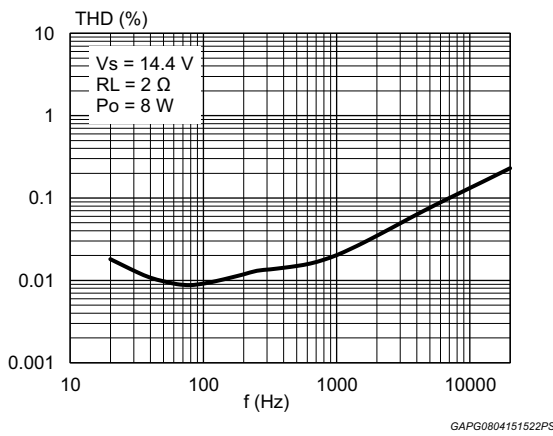

Figure 11. Distortion vs. output power (4 Ω, $V_S = 6\text{ V}$)

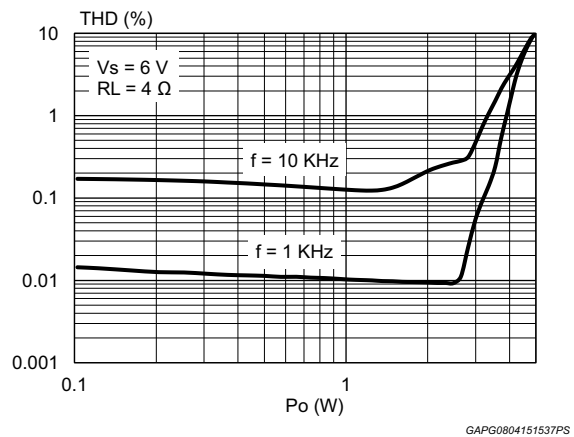

Figure 12. Distortion vs. output power (2 Ω, $V_S = 6\text{ V}$)

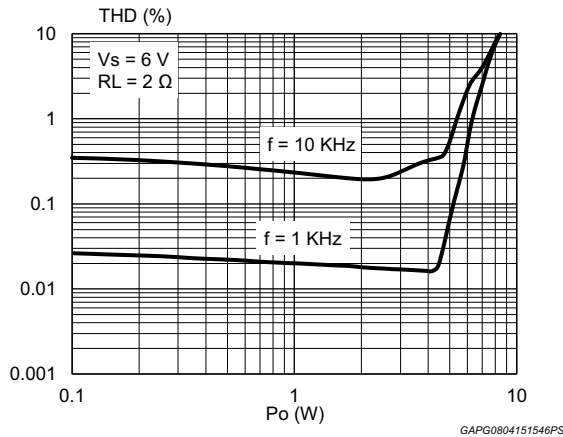

Figure 13. Supply voltage rejection vs. frequency

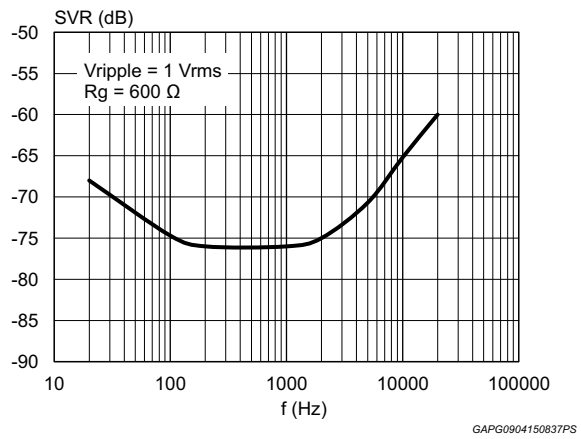

Figure 14. Crosstalk vs. frequency

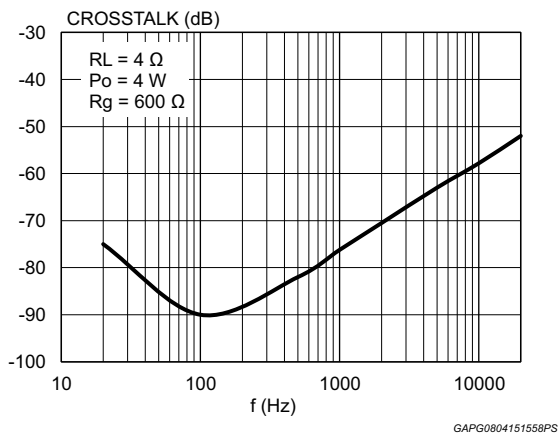

Figure 15. Total power dissipation & efficiency vs. P_o (4 Ω, Sine)

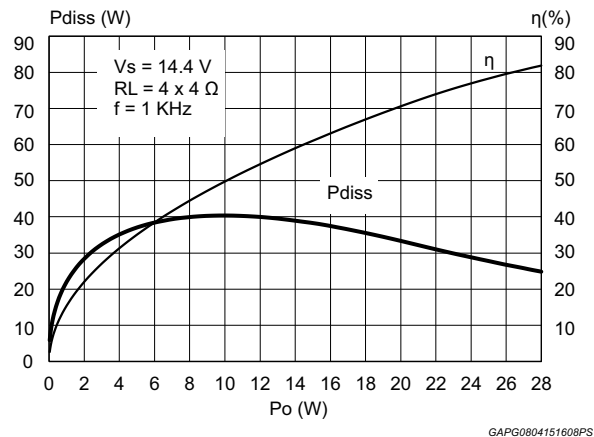
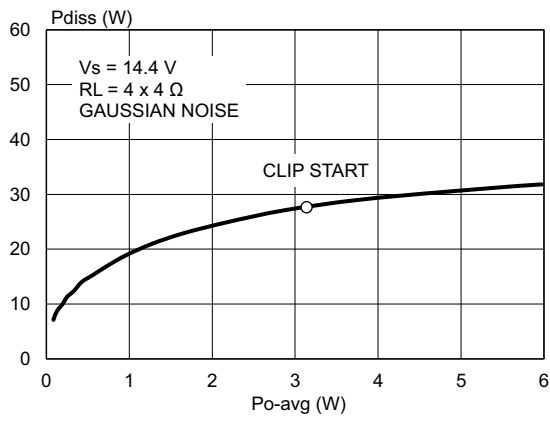
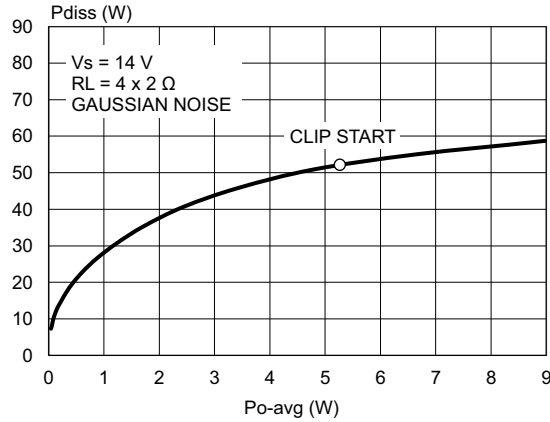

Figure 16. Power dissipation vs. average Output Power (4 Ω, audio program simulation)



GAPG0904150748PS

Figure 17. Power dissipation vs. average Output Power (2 Ω, audio program simulation)



GAPG0904150801PS

Figure 18. ITU R-ARM frequency response, weighting filter for transient pop

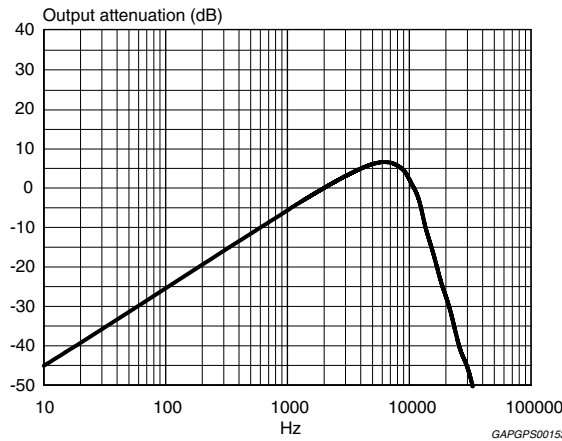

GAPGPS00153

4 General information

4.1 Operation

STPA008ZS inputs are ground-compatible. If the standard value for the input capacitors (0.22 μF) is adopted, the low frequency cut-off is 16 Hz. The input capacitors should be 1/4 of the capacitor connected to AC-GND pin for optimum pop performances.

Standby and mute pins are both 3.3 V CMOS compatible.

RC cells at both mute and stand-by pins have always to be used in order to smooth the transitions to prevent any audible transient noise.

In case the stand-by function is not used, it could steadily be connected to V_S , but a 470 kohm resistance should be present between the power supply and the pin.

The capacitance on SVR sets the start-up and shut-down times and helps to have pop-noise free transitions. Its minimum recommended value is 10 μF . To have a fast start-up time, the internal resistor on SVR pin, used to set the time constant, is reduced from 50 k Ω to 3 k Ω till voltage on SVR reaches $V_{CC}/4 - 2V_{BE}$ and then released. In this way the capacitor on SVR is charged very quickly to $V_{CC}/4$, as shown in the following figure.

The time constant to be assigned to the standby pin in order to obtain a virtually pop-free transition has to be slower than 2.5 V/ms.

Figure 19. SVR charge diagram

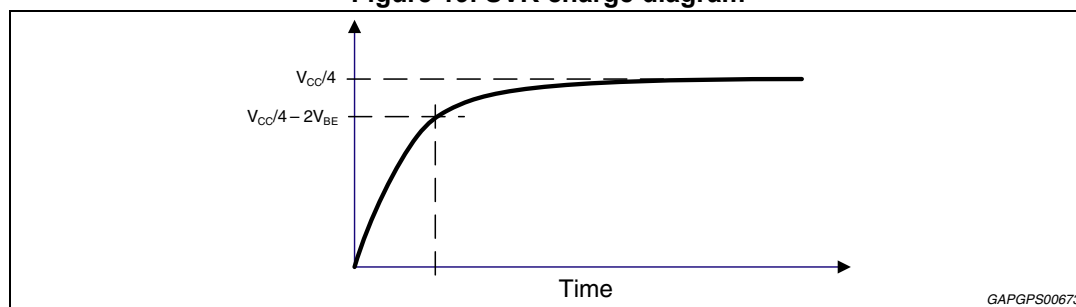

SVR pin accomplishes multiple functions:

- it is used as a reference voltage for input pins ($V_{CC}/4$)
- the capacitor connected to SVR improves the supply voltage ripple rejection
- it is used as a reference to generate the $V_{CC}/2$ reference for the outputs

When the amplifier goes in standby mode or goes out from this condition, it is recommended to put the amplifier in mute to ensure the absence of audible noise. Then the stand-by pin can be set to the appropriate value (ground or > 2.6 V) and the capacitor on SVR pin is discharged or charged consequently.

4.2 Battery variations

4.2.1 Low voltage operation

The most recent OEM specifications require automatic stop of car engine at traffic lights, in order to reduce emissions of polluting substances. STPA008ZS, thanks to its innovating design, allows a continuous operation when battery falls down. At 6 V it is still fully

operational, only the maximum output power is reduced according to the available voltage supply.

If the battery voltage drops below the minimum operating voltage of 6V the amplifier is fast muted, the capacitor on SVR is discharged and the amplifier restarts when the battery voltage returns to the correct voltage.

4.2.2 Cranks

STPA008ZS can sustain worst case cranks from 16 V to 6 V, continuing to play and without producing any pop noise.

Examples of battery cranking curves are shown below, indicating the shape and duration of allowed battery transitions.

Figure 20. Battery cranking curve example 1

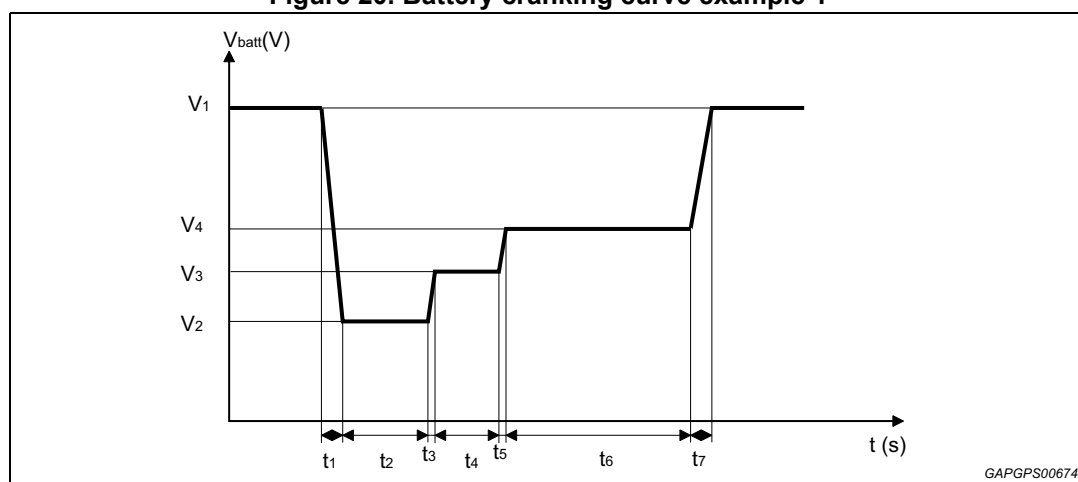

$V1 = 16\text{ V}; V2 = 6\text{ V}; V3 = 7\text{ V}; V4 = 8\text{ V}$

$t1 = 2\text{ ms}; t2 = 50\text{ ms}; t3 = 5\text{ ms}; t4 = 300\text{ ms}; t5 = 10\text{ ms}; t6 = 1\text{ s}; t7 = 2\text{ ms}$

Figure 21. Battery cranking curve example 2

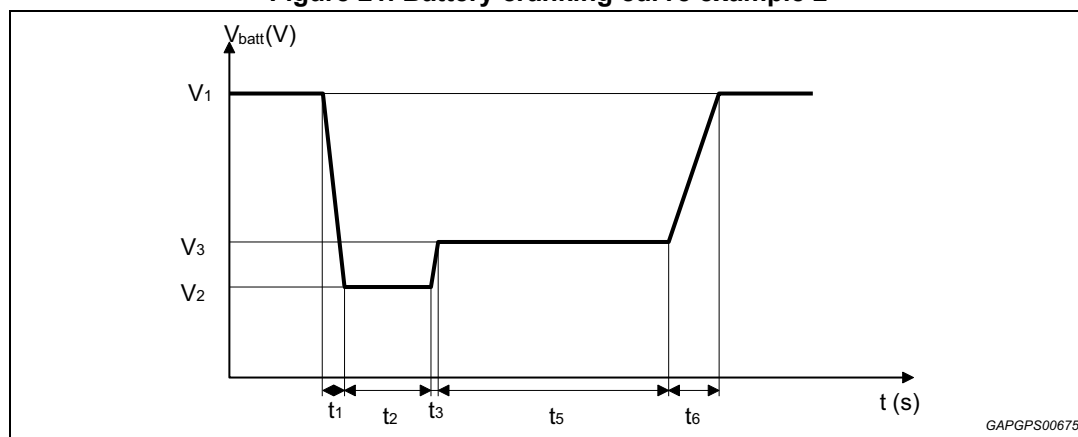

$V1 = 16\text{ V}; V2 = 6\text{ V}; V3 = 7\text{ V}$

$t1 = 2\text{ ms}; t2 = 5\text{ ms}; t3 = 15\text{ ms}; t5 = 1\text{ s}; t6 = 50\text{ ms}$

4.2.3 Advanced battery management (hybrid vehicles)

In hybrid vehicles, the engine ignition causes a fast increase of battery voltage which can reach 16 V in less than 10 ms. In addition to compatibility with low V_{batt} , STPA008ZS is able to sustain upwards fast battery transitions without causing unwanted audible effects, like pop noise, and without any sound interruption thanks to the innovative circuit topology.

Figure 22. Upwards fast battery transitions diagram

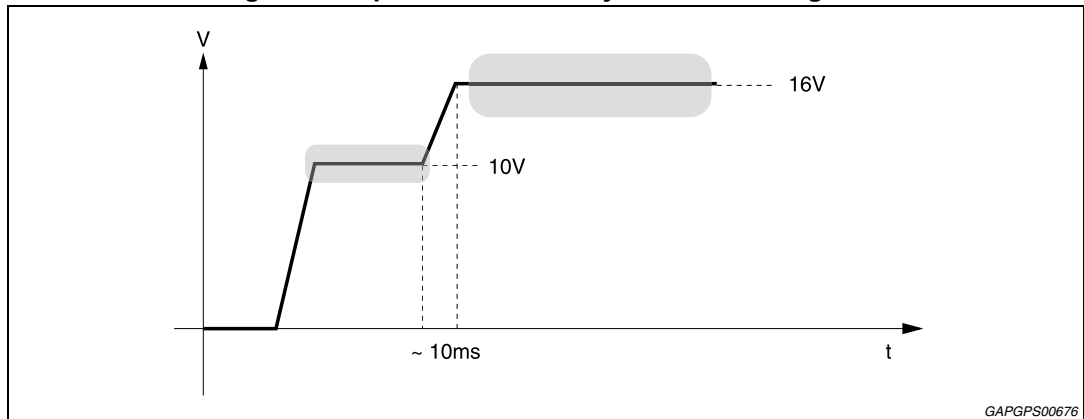

4.3 Protections

4.3.1 Short circuits and open load operation

When the IC detects a short circuit to ground, to V_{batt} or across the load, the output of the amplifier is put in three-state (high impedance condition).

In case of short circuit to ground or V_{cc}, the amplifier exits from the three-state condition only when the short-circuit is released and the output returns inside the limits imposed by an internal voltage comparator.

When a short across the load is present, the power stage sees an over-current and is brought in protection mode for about 100 μs. After this time, if the short circuit condition is removed the amplifier returns to play, otherwise the high impedance state is maintained and the check is repeated every 100 μs.

Disconnection of load (open load condition) doesn't affect the amplifier, which continues to play.

4.3.2 Over-voltage and load dump protection

When the battery voltage is higher than 19 V, the amplifier put in tri-state. It stops playing till the supply voltage returns in the permitted range.

The amplifier is protected against load dump surges having amplitude as high as 50 V and a rising time as low as 2 ms (see [Figure 23](#)).

Figure 23. Load dump protection diagram

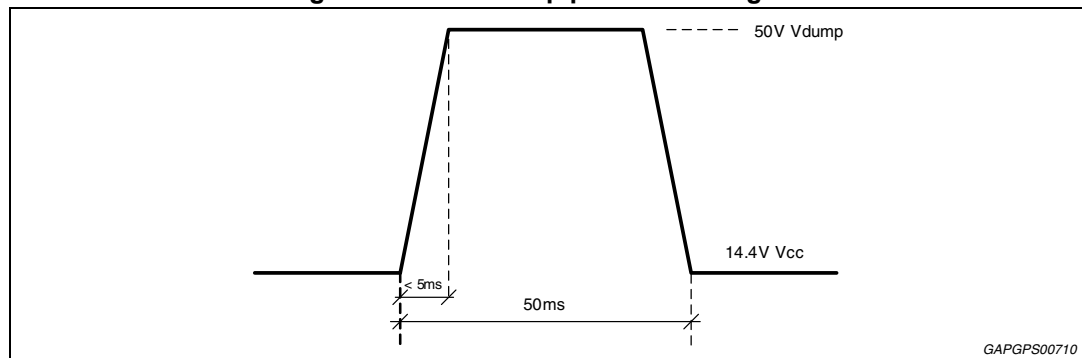

4.3.3 Thermal protection

If the junction temperature of the IC overcomes $T_j = 150\text{ }^\circ\text{C}$, a smooth mute is applied to reduce output power and limit power dissipation. If this is not enough and the junction temperature continues to increase, the amplifier is switched off when it reaches the maximum temperature of $170\text{ }^\circ\text{C}$.

Figure 24. Thermal protection diagram

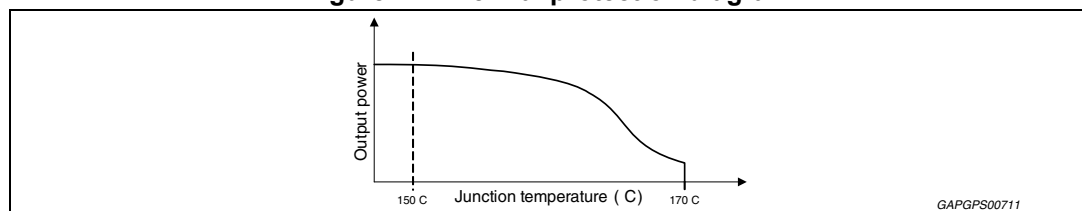

4.4 Warnings

4.4.1 DC offset detection (OD pin)

STPA008ZS integrates a DC offset detector to avoid that an anomalous input DC offset is multiplied by the amplifier gain producing a dangerous large offset at the output. In fact an output offset may lead to speakers damage for overheating. The detector works with the amplifier un-muted and no signal at the inputs.

When the differential output voltage is out of a window comparator with thresholds $\pm 2V$ (typ), the OD pin is pulled down.

4.4.2 Clipping detection and diagnostics (CD-DIAG pin)

When clipping occurs, the output signal is distorted. If the signal distortion on one of the output channels exceeds 1%, the CD-DIAG pin is pulled down. This information can be sent to an audio processor in order to reduce the input signal of the amplifier and reduce the clipping.

A short to ground and short to V_{cc} is pointed out by CD-DIAG. This pin is pulled down to 0 V till these shorts are present to inform the user a protection occurred.

CD-DIAG acts also as thermal warning. In fact every time T_j exceeds 140°C , it is pulled down to notify this occurrence.

Figure 25. Audio section waveforms

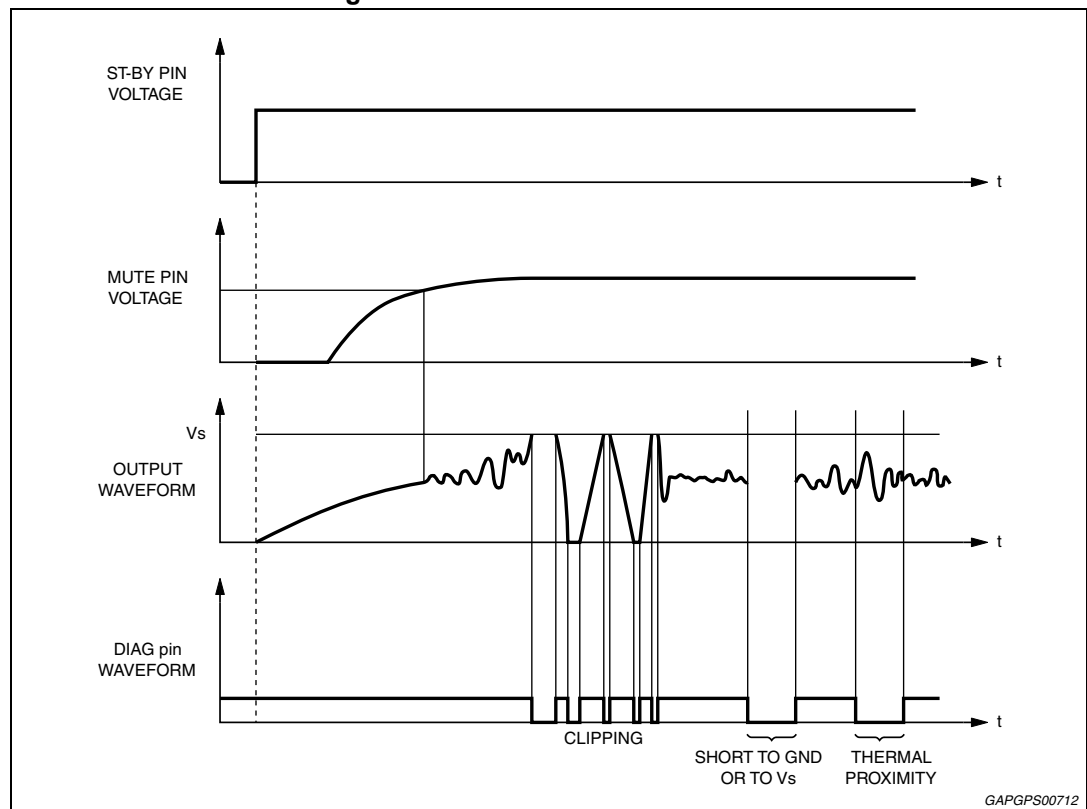

4.5 Heat sink definition

Assuming a power dissipation of 26 W (e.g. in the worst case situation of frequent clipping occurrence), considering T_j max is 150°C and assuming ambient temperature is 70 °C, the available temperature gap for a correct dissipation is 80 °C.

This means that the thermal resistance of the system R_{Th} has to be $80 \text{ °C}/26 \text{ W} = 3 \text{ °C/W}$.

The junction to case thermal resistance is 1 °C/W. So the heat sink thermal resistance should be approximately 2 °C/W. This would avoid any thermal shutdown occurrence even after long-term and full-volume operation.

5 Package information

In order to meet environmental requirements, ST offers these devices in different grades of **ECOPACK** packages, depending on their level of environmental compliance. ECOPACK specifications, grade definitions and product status are available at: www.st.com. ECOPACK is an ST trademark.

5.1 PowerSO-36 (slug up) package information

Figure 26. PowerSO-36 (slug up) package outline

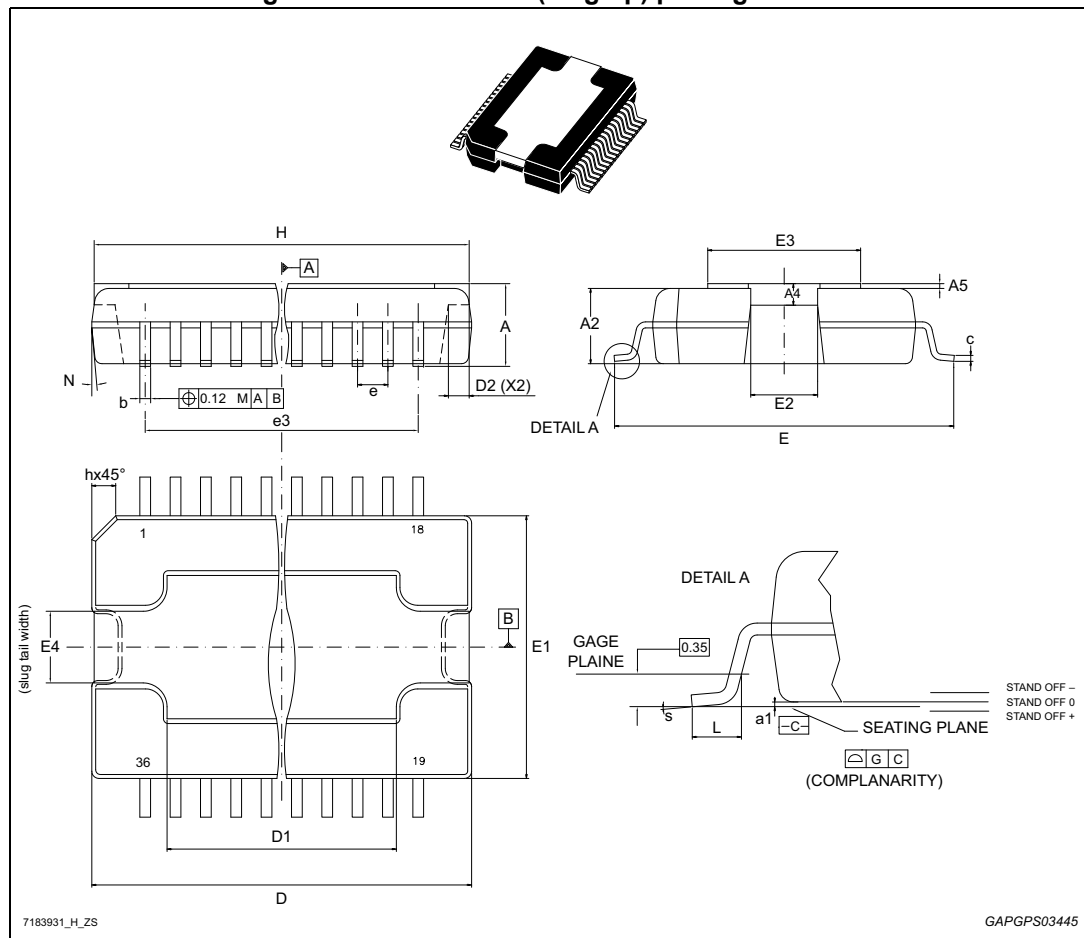

Table 6. PowerSO-36 (slug up) package mechanical data

Ref	Dimensions					
	Millimeters			Inches ⁽¹⁾		
	Min.	Typ.	Max.	Min.	Typ.	Max.
A	3.27	-	3.41	0.1287	-	0.1343
A2	3.1	-	3.18	0.1220	-	0.1252
A4	0.8	-	1.0	0.0315	-	0.0394
A5	-	0.2	-	-	0.0079	-
a1	0.03	-	-0.04	0.0012	-	-0.0016
b	0.22	-	0.38	0.0087	-	0.0150
c	0.23	-	0.32	0.0091	-	0.0126
D ⁽²⁾	15.8	-	16.0	0.6220	-	0.6299
D1	9.4	-	9.8	0.3701	-	0.3858
D2	-	1.0	-	-	0.0394	-
E	13.9	-	14.5	0.5472	-	0.5709
E1 ⁽²⁾	10.9	-	11.1	0.4291	-	0.4370
E2	-	-	2.9	-	-	0.1142
E3	5.8	-	6.2	0.2283	-	0.2441
E4	2.9	-	3.2	0.1142	-	0.1260
e	-	0.65	-	-	0.0256	-
e3	-	11.05	-	-	0.4350	-
G	0	-	0.075	0	-	0.0031
H	15.5	-	15.900	0.6102	-	0.6260
h	-	-	1.1	-	-	0.0433
L	0.8	-	1.1	0.0315	-	0.0433
N	-	-	10°	-	-	10°
s	-	-	8°	-	-	8°

1. Values in inches are converted from mm and rounded to 4 decimal digits.
2. 'D' and 'E1' do not include mold flash or protusions.
Mold flash or protusions shall not exceed 0.15mm (0.006").

5.2 PowerSO-36 marking information

Figure 27. PowerSO-36 marking information

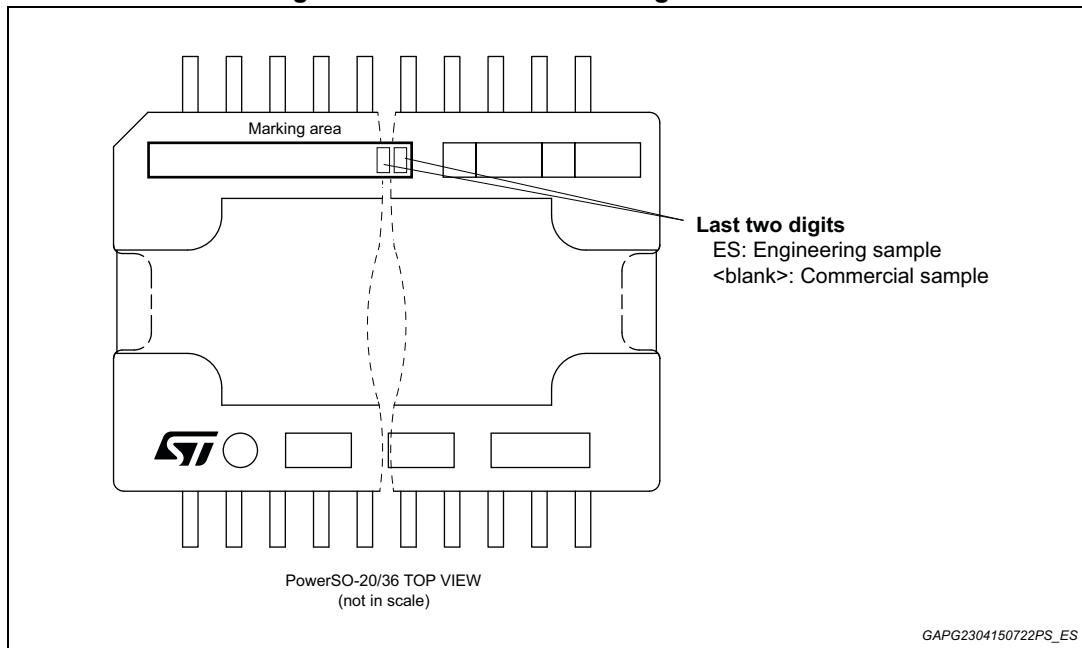

Parts marked as 'ES' are not yet qualified and therefore not approved for use in production. ST is not responsible for any consequences resulting from such use. In no event will ST be liable for the customer using any of these engineering samples in production. ST's Quality department must be contacted prior to any decision to use these engineering samples to run a qualification activity.

6 Revision history

Table 7. Document revision history

Date	Revision	Changes
04-Dec-2019	1	Initial release.
23-Sep-2021	2	Removed watermark "ST Restricted". Updated: – Section 3.3: Electrical characteristics ; – Table 3: Absolute maximum ratings .