

Ultrafast recovery - high voltage diode

Main product characteristics

$I_{F(AV)}$	30 A
V_{RRM}	1000 V
T_j	175° C
V_F (typ)	1.30 V
t_{rr} (typ)	42 ns

Features and benefits

- Ultrafast, soft recovery
- Very low conduction and switching losses
- High frequency and/or high pulsed current operation
- High reverse voltage capability
- High junction temperature
- Insulated package:
 - DOP3I
 - Electrical insulation = 2500 V_{RMS}
 - Capacitance = 12 pF

Description

The high quality design of this diode has produced a device with low leakage current, regularly reproducible characteristics and intrinsic ruggedness. These characteristics make it ideal for heavy duty applications that demand long term reliability.

Such demanding applications include industrial power supplies, motor control, and similar mission-critical systems that require rectification and freewheeling. These diodes also fit into auxiliary functions such as snubber, bootstrap, and demagnetization applications.

The improved performance in low leakage current, and therefore thermal runaway guard band, is an immediate competitive advantage for this device.

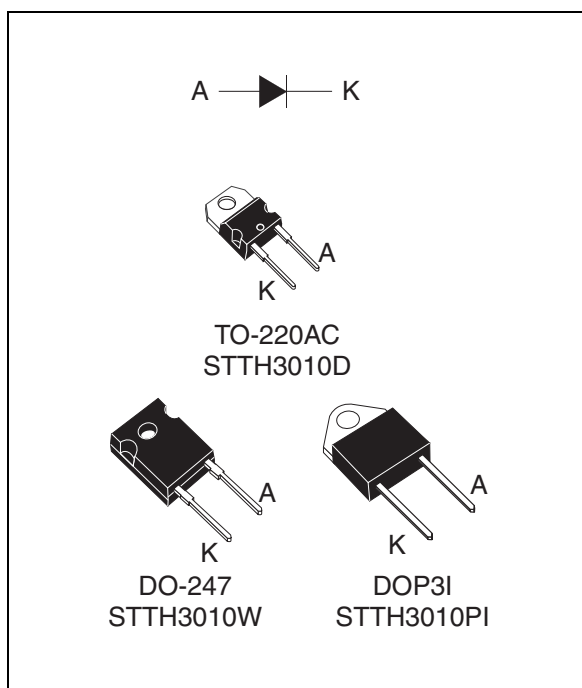

Order codes

Part Number	Marking
STTH3010D	STTH3010D
STTH3010W	STTH3010W
STTH3010PI	STTH3010PI

1 Characteristics

Table 1. Absolute ratings (limiting values at 25° C, unless otherwise specified)

Symbol	Parameter		Value	Unit	
V_{RRM}	Repetitive peak reverse voltage		1000	V	
$I_{F(RMS)}$	RMS forward current		50	A	
$I_{F(AV)}$	Average forward current, $\delta = 0.5$	TO-220 / DO-247	$T_c = 105^\circ\text{C}$	30	A
		DOP3I	$T_c = 65^\circ\text{C}$		
I_{FRM}	Repetitive peak forward current	$t_p = 5\ \mu\text{s}$, $F = 5\ \text{kHz}$ square	300	A	
I_{FSM}	Surge non repetitive forward current	$t_p = 10\ \text{ms}$ Sinusoidal	180	A	
T_{stg}	Storage temperature range		-65 to + 175	°C	
T_j	Maximum operating junction temperature		175	°C	

Table 2. Thermal parameters

Symbol	Parameter		Value	Unit
$R_{th(j-c)}$	Junction to case	TO-220 / DO-247	1.1	°C/W
		DOP3I	1.8	

Table 3. Static electrical characteristics

Symbol	Parameter	Test conditions		Min.	Typ	Max.	Unit
$I_R^{(1)}$	Reverse leakage current	$T_j = 25^\circ\text{C}$	$V_R = V_{RRM}$			15	μA
		$T_j = 125^\circ\text{C}$			10	100	
$V_F^{(2)}$	Forward voltage drop	$T_j = 25^\circ\text{C}$	$I_F = 30\ \text{A}$			2	V
		$T_j = 100^\circ\text{C}$			1.4	1.8	
		$T_j = 150^\circ\text{C}$			1.3	1.7	

1. Pulse test: $t_p = 5\ \text{ms}$, $\delta < 2\ \%$

2. Pulse test: $t_p = 380\ \mu\text{s}$, $\delta < 2\ \%$

To evaluate the conduction losses use the following equation:

$$P = 1.3 \times I_{F(AV)} + 0.013 I_{F(RMS)}^2$$

Table 4. Dynamic characteristics

Symbol	Parameter	Test conditions	Min.	Typ	Max.	Unit
t_{rr}	Reverse recovery time	$I_F = 1 \text{ A}$, $di_F/dt = -50 \text{ A}/\mu\text{s}$, $V_R = 30 \text{ V}$, $T_j = 25^\circ \text{ C}$			100	ns
		$I_F = 1 \text{ A}$, $di_F/dt = -100 \text{ A}/\mu\text{s}$, $V_R = 30 \text{ V}$, $T_j = 25^\circ \text{ C}$		53	70	
		$I_F = 1 \text{ A}$, $di_F/dt = -200 \text{ A}/\mu\text{s}$, $V_R = 30 \text{ V}$, $T_j = 25^\circ \text{ C}$		42	55	
I_{RM}	Reverse recovery current	$I_F = 30 \text{ A}$, $di_F/dt = -200 \text{ A}/\mu\text{s}$, $V_R = 600 \text{ V}$, $T_j = 125^\circ \text{ C}$		24	32	A
S	Softness factor	$I_F = 30 \text{ A}$, $di_F/dt = -200 \text{ A}/\mu\text{s}$, $V_R = 600 \text{ V}$, $T_j = 125^\circ \text{ C}$		1		
t_{fr}	Forward recovery time	$I_F = 30 \text{ A}$ $di_F/dt = 100 \text{ A}/\mu\text{s}$ $V_{FR} = 1.5 \times V_{Fmax}$, $T_j = 25^\circ \text{ C}$			450	ns
V_{FP}	Forward recovery voltage	$I_F = 30 \text{ A}$, $di_F/dt = 100 \text{ A}/\mu\text{s}$, $T_j = 25^\circ \text{ C}$		5		V

Figure 1. Conduction losses versus average current

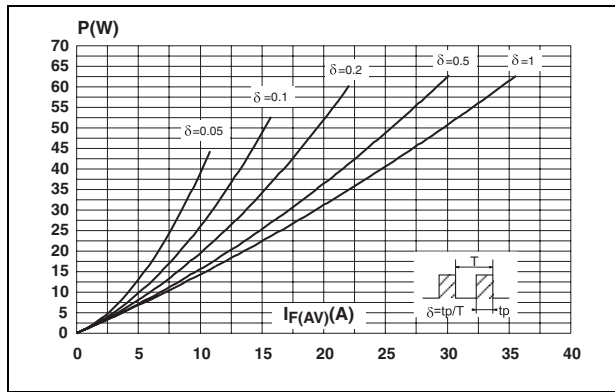

Figure 2. Forward voltage drop versus forward current

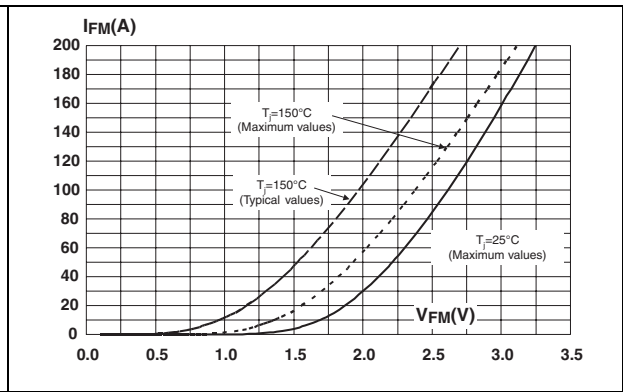

Figure 3. Relative variation of thermal impedance junction to case versus pulse duration

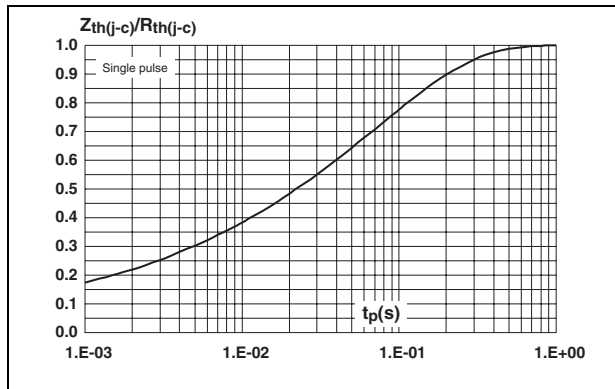

Figure 4. Peak reverse recovery current versus di_F/dt (typical values)

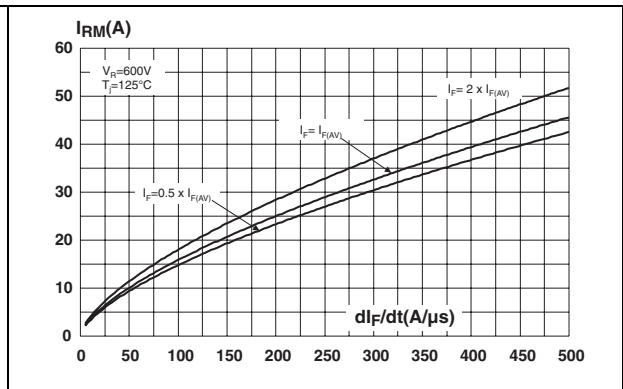

Figure 5. Reverse recovery time versus di_F/dt (typical values)

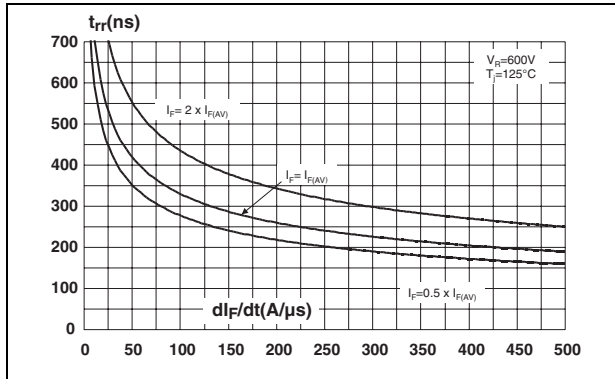

Figure 6. Reverse recovery charges versus di_F/dt (typical values)

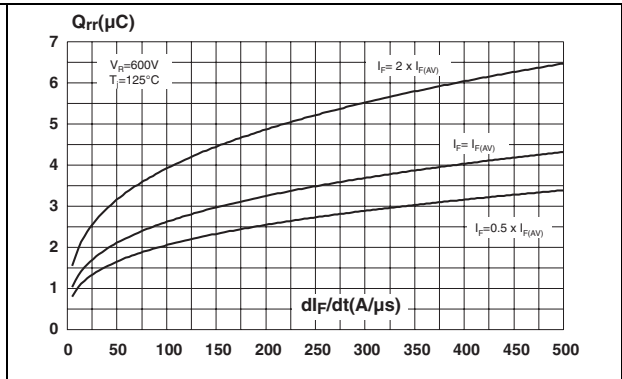

Figure 7. Softness factor versus di_F/dt (typical values)

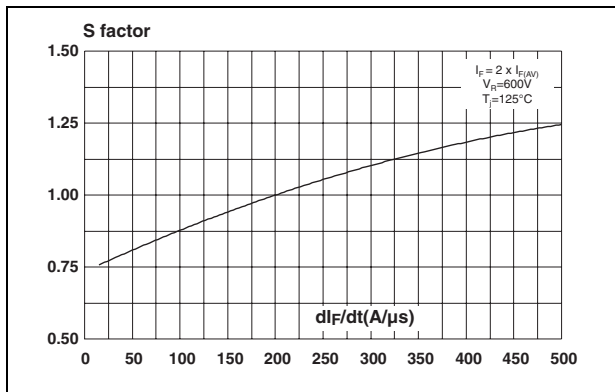

Figure 8. Relative variations of dynamic parameters versus junction temperature

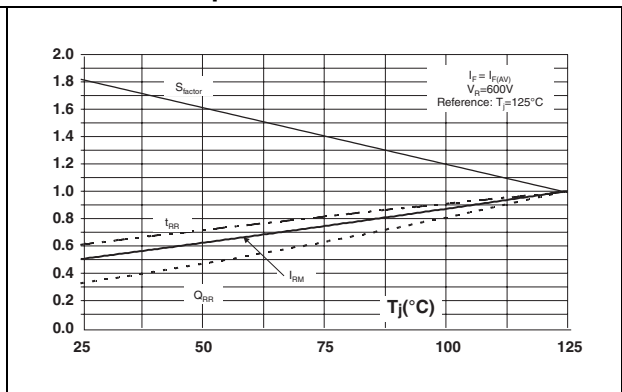

Figure 9. Transient peak forward voltage versus di_F/dt (typical values)

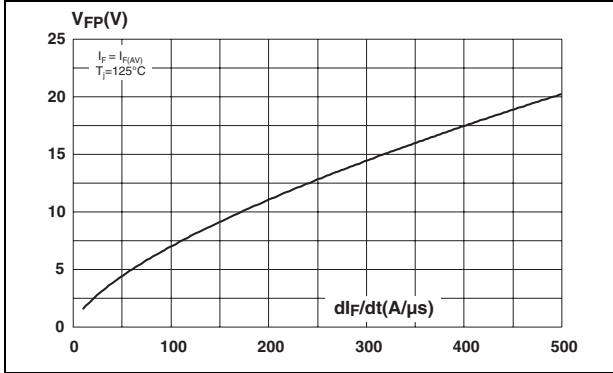

Figure 10. Forward recovery time versus di_F/dt (typical values)

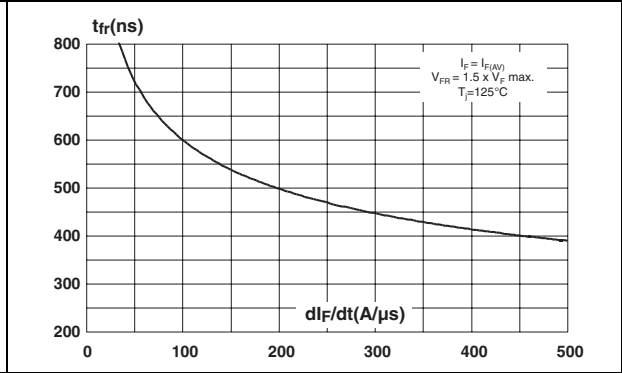
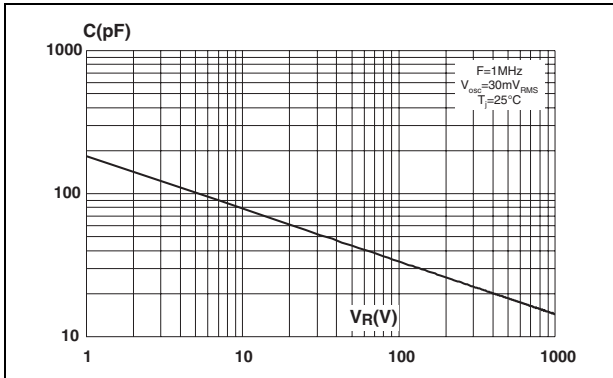

Figure 11. Junction capacitance versus reverse voltage applied (typical values)



2 Package information

Epoxy meets UL94, V0

Cooling method: by conduction (C)

Recommended torque value: 0.55 Nm (TO-220AC)

Recommended torque value: 0.80 Nm (SOD93, DOP31, and DO-247)

Maximum torque value: 0.7 Nm (TO-220AC)

Maximum torque value: 1.0 Nm (SOD93, DOP31, and DO-247)

Table 5. DO-247 dimensions

REF.	DIMENSIONS					
	Millimeters			Inches		
	Min.		Max	Min.		Max.
A	4.85		5.15	0.191		0.203
D	2.20		2.60	0.086		0.102
E	0.40		0.80	0.015		0.031
F	1.00		1.40	0.039		0.055
F2		2.00			0.078	
F3	2.00		2.40	0.078		0.094
G		10.90			0.429	
H	15.45		15.75	0.608		0.620
L	19.85		20.15	0.781		0.793
L1	3.70		4.30	0.145		0.169
L2		18.50			0.728	
L3	14.20		14.80	0.559		0.582
L4		34.60			1.362	
L5		5.50			0.216	
M	2.00		3.00	0.078		0.118
V		5°			5°	
V2		60°			60°	
Dia.	3.55		3.65	0.139		0.143

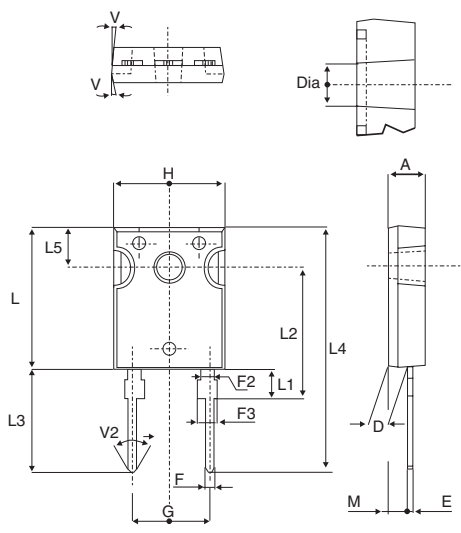

Table 6. T0-220AC dimensions

REF.	DIMENSIONS			
	Millimeters		Inches	
	Min.	Max.	Min.	Max.
A	4.40	4.60	0.173	0.181
C	1.23	1.32	0.048	0.051
D	2.40	2.72	0.094	0.107
E	0.49	0.70	0.019	0.027
F	0.61	0.88	0.024	0.034
F1	1.14	1.70	0.044	0.066
G	4.95	5.15	0.194	0.202
H2	10.00	10.40	0.393	0.409
L2	16.40 typ.		0.645 typ.	
L4	13.00	14.00	0.511	0.551
L5	2.65	2.95	0.104	0.116
L6	15.25	15.75	0.600	0.620
L7	6.20	6.60	0.244	0.259
L9	3.50	3.93	0.137	0.154
M	2.6 typ.		0.102 typ.	
Diam. I	3.75	3.85	0.147	0.151

Table 7. DOP3I dimensions

REF.	DIMENSIONS			
	Millimeters		Inches	
	Min.	Max.	Min.	Max.
A	4.40	4.60	0.173	0.181
b	1.20	1.40	0.047	0.055
c	1.45	1.55	0.057	0.061
c1	0.50	0.70	0.020	0.028
D	12.15	13.10	0.474	0.516
E	15.10	15.50	0.594	0.610
E1	7.55	7.75	0.297	0.305
e	10.80	11.30	0.425	0.445
G	20.4	21.10	0.815	0.831
L	14.35	15.60	0.565	0.614
P	4.08	4.17	0.161	0.164
Q	2.70	2.90	0.106	0.114
R	4.60 typ.		0.181 typ.	
Y	15.80	16.50	0.622	0.650

In order to meet environmental requirements, ST offers these devices in ECOPACK® packages. These packages have a Lead-free second level interconnect . The category of second level interconnect is marked on the package and on the inner box label, in compliance with JEDEC Standard JESD97. The maximum ratings related to soldering conditions are also marked on the inner box label. ECOPACK is an ST trademark. ECOPACK specifications are available at: www.st.com.

3 Ordering information

Part Number	Marking	Package	Weight	Base qty	Delivery mode
STTH3010D	STTH3010D	TO-220AC	1.86 g	50	Tube
STTH3010PI	STTH3010PI	DOP3I	4.46 g	30	Tube
STTH3010W	STTH3010W	DO-247	4.4 g	30	Tube

4 Revision history

Date	Revision	Description of Changes
02-Mar-2006	1	First issue.