

Wideband RF/microwave PLL fractional/integer frequency synthesizer with integrated VCOs and LDOs

Datasheet - production data

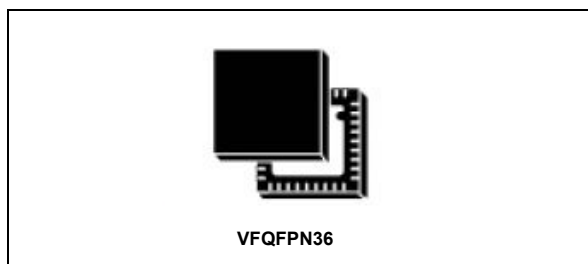

Features

- Output frequency range: 1.925 GHz to 16 GHz
 - RF out 1 (VCO, VCO÷2): 1.925-8.0 GHz
 - RF out 2 (VCO x 2): 7.7-16.0 GHz
- Very low noise
 - Normalized phase noise floor: -227 dBc/Hz
 - VCO phase noise (6.0 GHz): -131 dBc/Hz @ 1 MHz offset
 - Noise floor (6.0 GHz): -158 dBc/Hz
 - Phase noise (12 GHz): -125 dBc/Hz @ 1 MHz offset
 - Noise floor (12 GHz): -154 dBc/Hz
- Integrated VCOs with fast automatic center frequency calibration
- External VCO option with 5 V charge pump
- Fundamental VCO rejection at doubler output higher than 20 dB
- Internally broadband matched RF outputs delivering +6 dBm @6 GHz and +4 dBm @12 GHz single-ended
- Integrated low noise LDOs
- Maximum phase detector frequency: 100 MHz
- Exact frequency mode
- Differential reference clock input (LVDS and LVECPL compliant) supporting up to 800 MHz
- Integrated reference crystal oscillator core
- R/W SPI interface
- Logic compatibility/tolerance 1.8 V/3.3 V

- Supply voltage: 3.0 V to 5.4 V
- Small size exposed pad VFQFPN36 package 6x6x1.0 mm
- Process: BICMOS 0.25 μ m SiGe

Applications

- Infrastructure equipment
- Satellite communications for terrestrial applications
- Other wireless communication systems

Table 1. Device summary

Order Code	Package	Packing
STUW81300-1T	VFQFPN36	Tray
STUW81300-1TR	VFQFPN36	Tape and reel
STUW81300T	VFQFPN36	Tray
STUW81300TR	VFQFPN36	Tape and reel

Description

The STuW81300 includes a dual architecture frequency synthesizer (Fractional-N and Integer-N), four low phase noise VCOs with a fast automatic center frequency calibration providing a very wide frequency range, from 1.925 GHz to 16 GHz, with a single device.

The STuW81300 optimizes size and cost of the final application by the integration of low noise LDO voltage regulators and internally matched broadband RF outputs.

Additional features include a crystal oscillator core, external VCO mode, output mute function and low power mode to trade current consumption with phase noise performance and/or output level.

Contents

- 1 Functional block diagram 6**
- 2 Pin definitions 7**
- 3 Absolute maximum ratings 10**
- 4 Operating conditions 11**
- 5 Electrical specifications 13**
- 6 Typical performance characteristics 19**
- 7 Circuit description 23**
 - 7.1 Reference input stage 23
 - 7.2 Reference divider 23
 - 7.3 PLL N divider 24
 - 7.4 Fractional spurs and compensation mechanism 25
 - 7.4.1 PFD delay mode 26
 - 7.4.2 Charge pump leakage current 26
 - 7.4.3 Down-split current 26
 - 7.5 Phase frequency detector (PFD) 27
 - 7.6 Lock detect 27
 - 7.7 Charge pump 28
 - 7.8 Fast lock mode 28
 - 7.9 Cycle slip reduction 29
 - 7.10 Voltage controlled oscillators (VCOs) 29
 - 7.11 RF output stage 31
 - 7.12 Low-power functional modes 32
 - 7.13 LDO voltage regulators 32
 - 7.14 STuW81300 register programming 33
 - 7.15 STuW81300 register summary 35
 - 7.16 STuW81300 register descriptions 36

7.17	Power-on sequence	51
7.18	Example register programming	51
8	Application information	52
8.1	Application diagram	52
8.2	Thermal PCB design considerations	53
8.3	Robust VCO calibration over full temperature range	53
9	Package information	56
9.1	VFQFPN36 package information	56
10	Evaluation kit	59
11	Revision history	60

List of tables

Table 1.	Device summary	1
Table 2.	Pin descriptions	8
Table 3.	Absolute maximum ratings	10
Table 4.	Operating conditions	11
Table 5.	Digital logic levels	12
Table 6.	Electrical specifications	13
Table 7.	Phase noise specifications	17
Table 8.	Current value versus selection	28
Table 9.	SPI timings	34
Table 10.	SPI Register map (address 12 to 15 not available)	35
Table 11.	Example of data for robust VCO calibration routine to be stored in the application memory.	55
Table 12.	VFQFPN - 36 pin, 6x6 mm, 0.5 mm pitch very thin profile fine pitch quad flat package mechanical data	57
Table 13.	STuW81300 evaluation-kit order codes	59
Table 14.	Document revision history	60

List of figures

Figure 1.	STuW81300 functional block diagram	6
Figure 2.	Top view	7
Figure 3.	VCO open loop phase noise (5 V supply)	19
Figure 4.	Closed loop phase noise (5 V supply)	19
Figure 5.	VCO Open loop phase noise at 5.3 GHz vs. supply	19
Figure 6.	VCO open loop phase noise over Frequency vs. supply	19
Figure 7.	Single sideband integrated phase noise vs. frequency and supply ($F_{\text{PFD}}=50$ MHz)	20
Figure 8.	Average K_{VCO} over VCO frequency and supply	20
Figure 9.	Phase noise and fractional spurs at 5952.5 MHz vs. supply ($F_{\text{PFD}}=50$ MHz)	20
Figure 10.	Phase noise and fractional spurs at 11502.5 MHz vs. supply ($F_{\text{PFD}}=50$ MHz)	20
Figure 11.	Output power level vs. temperature – RF1 output (5.0 V supply)	20
Figure 12.	Output power level vs. temperature– RF2 output (5.0 V supply)	20
Figure 13.	VCO feedthrough at RF2 output vs. fundamental VCO frequency	21
Figure 14.	Typical spur level vs offset from 12 GHz (5.0 V supply, $F_{\text{PFD}}=50$ MHz)	21
Figure 15.	Typical spur level at PFD offset over carrier frequency (5.0 V supply)	21
Figure 16.	10 kHz and 2.5 MHz fractional spur (integer boundary, 5.0 V supply, $F_{\text{PFD}}=50$ MHz)	21
Figure 17.	Frequency settling with VCO calibration – wideband view	21
Figure 18.	Frequency settling with VCO calibration – narrowband view	21
Figure 19.	Overall current consumption vs. temperature (5.0 V supply, $F_{\text{PFD}}=50$ MHz)	22
Figure 20.	Overall current consumption vs. temperature (3.6 V supply, $F_{\text{PFD}}=50$ MHz)	22
Figure 21.	Figure of merit	22
Figure 22.	Reference clock buffer configurations: single-ended (A), differential (B), crystal mode (C)	23
Figure 23.	PFD diagram	27
Figure 24.	SPI Protocol	33
Figure 25.	SPI timing diagram	34
Figure 26.	Application diagram	52
Figure 27.	VFQFPN - 36 pin, 6x6 mm, 0.5 mm pitch very thin profile fine pitch quad flat package outline	56
Figure 28.	VFQFPN - 36 pin, 6x6 mm, 0.5 mm pitch very thin profile fine pitch quad flat package recommended footprint	58

1 Functional block diagram

Figure 1. STuW81300 functional block diagram

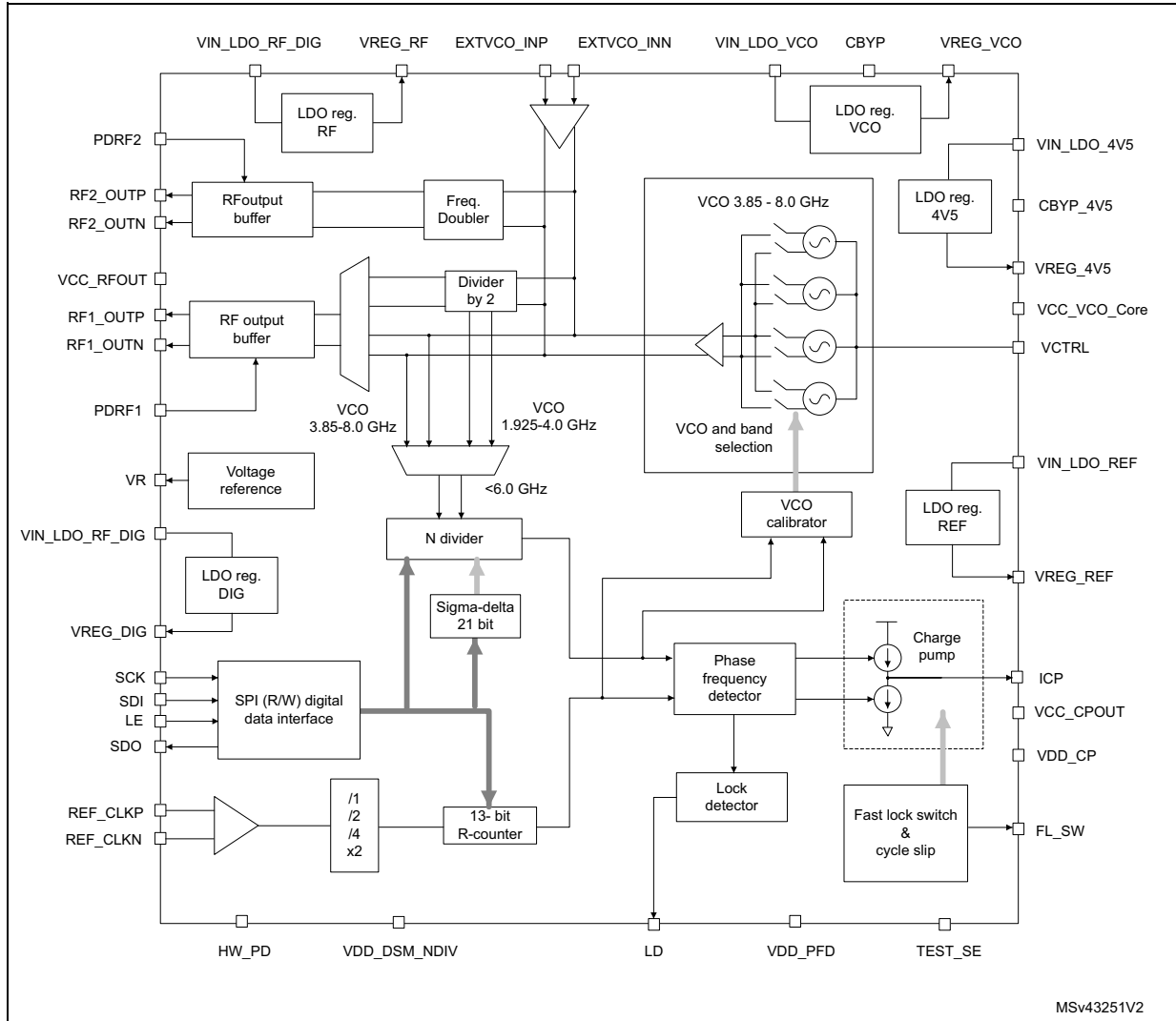

Table 2. Pin descriptions

Pin No	Name	Description	Observation
1	CBYP_4V5	Connection for 4.5 V regulator bypass capacitor	-
2	VREG_4V5	Regulated output voltage of 4.5 V regulator	-
3	VCC_VCO_Core	Supply voltage of VCO Core	Must be connected to VREG_4V5
4	HW_PD	HW Power Down	CMOS Schmitt Triggered Input, 1.8 V compatible, 3.3 V tolerant
5	PDRF1	RF1 output stage Power Down control	CMOS Schmitt Triggered Input, 1.8 V compatible, 3.3 V tolerant
6	PDRF2/FL_SW	RF2 output stage Power Down control / Fast-Lock switch	CMOS Schmitt Triggered Input, 1.8 V compatible, 3.3 V tolerant. Can be also used as switch for fast-lock loop filter configuration
7	CBYP	Connection of VCO regulator bypass capacitor	-
8	VREG_VCO	Regulated output voltage of VCO circuitry regulator	-
9	VIN_LDO_VCO	Supply voltage of VCO circuitry regulator	-
10	VR	Connection of reference voltage filtering capacitor	-
11	VCTRL	VCO control voltage	-
12	EXTVCO_INP	External VCO positive input	Must be connected to ground if external VCO is not used
13	EXTVCO_INN	External VCO negative input	Must be connected to ground if external VCO is not used
14	VDD_CP	Digital charge-pump supply voltage	Must be connected to VREG_VCO
15	ICP	PLL charge pump output	-
16	VCC_CPOUT	Supply voltage for Charge Pump output stage	Must be connected to VREG_4V5
17	VDD_PFD	Supply voltage of digital phase/frequency detector	Must be connected to VREG_REF
18	VIN_LDO_REF	Supply voltage for reference clock regulator	-
19	VREG_REF	Regulated supply voltage of PLL	-
20	REF_CLKN	Reference clock negative input	-
21	REF_CLKP	Reference clock positive input	-
22	LD_SDO	Lock Detector / SPI Data output	CMOS push-pull Output 2.5 V with slew rate control or open drain (1.8 V to 3.3 V tolerant)
23	SDI	SPI Data input	CMOS Schmitt triggered Input, 1.8 V compatible, 3.3 V tolerant
24	SCK	SPI clock	CMOS Schmitt triggered Input, 1.8 V compatible, 3.3 V tolerant

Table 2. Pin descriptions (continued)

Pin No	Name	Description	Observation
25	LE	SPI load enable	CMOS Schmitt triggered Input, 1.8 V compatible, 3.3 V tolerant
26	VDD_DSM_NDIV	Supply voltage of Delta-Sigma modulator and loop divider	Must be connected to VREG_DIG
27	VREG_DIG	Regulated supply voltage of digital circuitry	-
28	VIN_LDO_RF_DIG	Supply voltage of RF and digital circuitry regulators	-
29	VREG_RF	Regulated supply voltage of RF blocks	-
30	RF1_OUTN	Direct and divided by 2 negative output	Internally matched to 50 ohm
31	RF1_OUTP	Direct and divided by 2 positive output	Internally matched to 50 ohm
32	VCC_RFOUT	Supply voltage for RF output stages	Must be connected to VREG_4V5
33	RF2_OUTN	Doubler negative output	Internally matched to 50 ohm
34	RF2_OUTP	Doubler positive output	Internally matched to 50 ohm
35	TEST_SE	Test pin	Must be connected to GND
36	VIN_LDO_4V5	Supply voltage of 4.5V regulator	-

3 Absolute maximum ratings

Table 3. Absolute maximum ratings

Symbol	Parameter	Value	Unit
V _{CC}	Supply voltage (LDO input pins #9, 18, 28, 36)	-0.3 to 5.4	V
T _{stg}	Storage temperature	+150	°C
ESD	Electrical Static Discharge		
	– HBM ⁽¹⁾ – CDM-JEDEC Standard	2 0.5	kV

1. The maximum rating of the ESD protection circuitry on pin 21 (REF_CLKP) is 1.5 kV.

4 Operating conditions

Table 4. Operating conditions

Symbol	Parameter	Test conditions	Min	Typ	Max	Unit
V _{CC}	Supply voltage (LDO input pins #9, 18, 28)	-	3.0	-	5.4	V
	Supply voltage (LDO input pin #36)	-	3.6	-	5.4	V
I _{CC}	Current Consumption	8 GHz VCO, Doubler ON, Output2 frequency at 16 GHz	-	290	-	mA
T _A	Operating ambient temperature	-	-40	-	85	°C
T _J	Maximum junction temperature	-	-	-	125	°C
Θ _{JA}	Junction to ambient package thermal resistance ⁽¹⁾	Multilayer JEDEC board	-	33	-	°C/W
Θ _{JB}	Junction to board package thermal resistance ⁽¹⁾	Multilayer JEDEC board	-	18	-	°C/W
Θ _{JC}	Junction to case package thermal resistance ⁽¹⁾	Multilayer JEDEC board	-	3	-	°C/W
Ψ _{JB}	Thermal characterization parameter junction to board ⁽¹⁾	Multilayer JEDEC board	-	17	-	°C/W
Ψ _{JT}	Thermal characterization parameter junction to top case ⁽¹⁾	Multilayer JEDEC board	-	0.5	-	°C/W

1. Refer to JEDEC standard JESD 51-12 for a detailed description of the thermal resistances and thermal parameters. Data here presented are referring to a Multilayer board according to JEDEC standard.

$$T_J = T_A + \Theta_{JA} * P_{diss} \text{ (in order to estimate } T_J \text{ if ambient temperature } T_A \text{ and dissipated power } P_{diss} \text{ are known)}$$

$$T_J = T_B + \Psi_{JB} * P_{diss} \text{ (in order to estimate } T_J \text{ if ambient temperature } T_B \text{ and dissipated power } P_{diss} \text{ are known)}$$

$$T_J = T_T + \Psi_{JT} * P_{diss} \text{ (in order to estimate } T_J \text{ if ambient temperature } T_T \text{ and dissipated power } P_{diss} \text{ are known)}$$

Table 5. Digital logic levels

Symbol	Parameter	Test conditions	Min	Typ	Max	Unit
Vdd	Internal Supply for digital circuits	-	-	2.6	-	V
Vil	Low level input voltage	Schmitt input	0	-	0.6	V
Vih	High level input voltage	Schmitt input	1.2	-	3.6	V
Vol	Low level output voltage	$I_{OL} = 4 \text{ mA}$	-	-	0.2	V
Voh	High level output voltage	$I_{OH} = 4 \text{ mA}$	Vdd-0.2	-	-	V

5 Electrical specifications

All electrical specifications are given at 25 °C T_{AMB} and in a full-current mode, unless otherwise stated.

Table 6. Electrical specifications

Symbol	Parameter	Condition	Min	Typ	Max	Units
Output frequency range						
F_{OUT}	Output frequency	Direct output (Output 1 only)	3850	-	8000	MHz
		Divider by 2 output (Output 1 only)	1925	-	4000	MHz
		Doubler output (Output 2 only)	7700	-	16000	MHz
VCO dividers						
N	VCO divider ratio	Integer Mode	24	-	131071	-
		Fractional mode (DSM 1 st order)	24	-	510	-
		Fractional mode (DSM 2 nd order)	25	-	509	-
		Fractional mode (DSM 3 rd order)	27	-	507	-
		Fractional mode (DSM 4 th order)	31	-	503	-
Xtal oscillator						
F_{XTAL}	XTAL frequency range	-	10	-	50	MHz
ESR_{XTAL}	XTAL ESR	-	-	-	50	Ω
P_{XTAL}	XTAL power dissipation	-	-	-	5	mW
CIN_{XTAL}	XTAL oscillator input capacitance	Single ended	0.6	-	-	pF
PN_{XTAL}	XTAL oscillator phase noise floor	10 MHz XTAL	-	-162	-	dBc/Hz
TOL_{XTAL}	XTAL oscillator accuracy	@12 MHz, 25 °C	-	-	10	ppm
Reference clock and phase frequency detector						
F_{ref}	Reference input frequency ⁽¹⁾	-	10	-	800	MHz
	Reference input sensitivity	Differential mode	0.2	1	1.25	Vp
		Single ended mode	0.35	1	1.25	Vp
PN_{REFIN}	Reference input buffer phase noise floor	Single ended mode @100 MHz, sinusoidal signal 1.25 Vp	-	-163	-	dBc/Hz
		LVDS signal @100 MHz 400 mVp	-	-159	-	dBc/Hz
I_{REF}	Current consumption ⁽²⁾	Analog buffer	-	11.5	-	mA
		CMOS digital inverter buffer	-	1	-	
		XTAL oscillator mode	-	5	-	

Table 6. Electrical specifications (continued)

Symbol	Parameter	Condition	Min	Typ	Max	Units
R	Reference divider ratio	-	1	-	8191	
F _{PFD}	PFD input frequency ⁽³⁾	-	-	-	100	MHz
F _{STEP}	Frequency step ⁽³⁾	LO direct output	-	47.5	-	Hz
		LO with divider by 2	-	23.75	-	Hz
		LO with doubler	-	95	-	Hz
Charge pump						
I _{CP}	ICP sink/source	5-bit programmable	-	-	4.9	mA
V _{OCP}	Output voltage range on ICP pin (pin#14)	-	0.4	-	V _{CCCPOUT} -0.4	V
-	Comparison frequency Spurs ⁽⁴⁾⁽⁵⁾	VCO on output 1	-	-85	-	dBc
-	In-band fractional spurs ⁽⁵⁾⁽⁶⁾	VCO on output 1	-	-50	-	
VCOs						
I _{VCOCore}	Oscillator core current consumption	@ 4 GHz and 4.5 V supply	-	57	-	mA
I _{VCOBUF}	VCO buffer consumption	-	-	16	-	mA
K _{VCO}	VCO gain @4.5 V supply	-	-	30-85	-	MHz/V
	VCO gain @3.3 V supply	-	-	50-105	-	
ΔT_{LOCK} - F_{VCO} ≤ 5500MHz, VCC_VCO_Core = 3.3 V⁽⁷⁾⁽⁸⁾						
ΔT _{FALL}	Temperature variation, falling temperature	T _J max = 100 °C	110	-	-	°C
ΔT _{RISE}	Temperature variation, rising temperature	T _J max = 100 °C	95	-	-	°C
ΔT_{LOCK} - F_{VCO} > 5500MHz, VCC_VCO_Core = 3.3 V⁽⁷⁾⁽⁸⁾						
ΔT _{FALL}	Temperature variation, falling temperature	T _J max = 100 °C	100	-	-	°C
ΔT _{RISE}	Temperature variation, rising temperature	T _J max = 80 °C	85	-	-	°C
		T _J max = 90 °C	80	-	-	°C
		T _J max = 100 °C	75	-	-	°C
ΔT_{LOCK} - F_{VCO} ≤ 6800MHz, VCC_VCO_Core = 4.5 V⁽⁷⁾⁽⁸⁾						
ΔT _{FALL}	Temperature variation, falling temperature	T _J max = 100 °C	110	-	-	°C
ΔT _{RISE}	Temperature variation, rising temperature	T _J max = 100 °C	95	-	-	°C

Table 6. Electrical specifications (continued)

Symbol	Parameter	Condition	Min	Typ	Max	Units
$\Delta T_{\text{LOCK}} - F_{\text{VCO}} > 6800\text{MHz}$, $V_{\text{CC_VCO_Core}} = 4.5\text{ V}$ ⁽⁷⁾⁽⁸⁾						
ΔT_{FALL}	Temperature variation, falling temperature	$T_{\text{J max}} = 100\text{ }^{\circ}\text{C}$	110	-	-	$^{\circ}\text{C}$
ΔT_{RISE}	Temperature variation, rising temperature	$T_{\text{J max}} = 80\text{ }^{\circ}\text{C}$	90	-	-	$^{\circ}\text{C}$
		$T_{\text{J max}} = 90\text{ }^{\circ}\text{C}$	80	-	-	
		$T_{\text{J max}} = 100\text{ }^{\circ}\text{C}$	75	-	-	
RF output stage						
P_{OUT}	Output level	1.925 GHz to 8 GHz (Output 1 only single ended)	+2	-	+8	dBm
		7.7 GHz to 16 GHz (Output 2 only single ended)	-1	-	+5	
Z_{OUT}	Output impedance	Differential	-	100	-	Ω
		Single-ended	-	50	-	
R_{L}	Return loss	Matched to 50 ohm	-	10	-	dB
-	Unwanted harmonic Spur leakage ⁽⁹⁾	Differential output (output 1 and 2)	-	-20	-	dBc
I_{RFOUTBUF}	RF output buffer current consumption	1.925 GHz to 8 GHz (+5 dBm output power)	-	25	-	mA
		7.7 GHz to 16 GHz (+3 dBm output power)	-	35	-	
PLL miscellaneous						
I_{PLL}	PLL current consumption ⁽¹⁰⁾	Prescaler, digital dividers, misc.	-	16	-	mA
I_{DSM}	$\Delta\Sigma$ modulator current consumption ⁽¹⁰⁾	-	-	3.5	-	mA

1. The maximum frequency of the Reference Divider is 200 MHz; when using higher reference clock frequency (up to the max. value of 800 MHz) the internal divider by 2 or divider by 4 must be enabled.
The fractional mode is allowed in the full frequency range only with reference clock frequency >11.93 MHz
With reference clock frequency in the range 10 MHz to 11.93 MHz, due to the limits of N value in fractional mode, the full VCO frequencies would not be addressed in fractional mode; in this case the frequency doubler in the reference path can be enabled.
2. Reference clock signal @ 100 MHz, R=2.
3. The minimum frequency step is obtained as $F_{\text{PFD}} / (2^{21})$; these typical values are obtained considering $F_{\text{PFD}} = 100\text{ MHz}$.
4. PFD frequency leakage.
5. For VCO divided by 2 (Output 1) subtract 6dB; for VCO doubled (Output 2) add 6dB.
6. This is the level within the PLL loop bandwidth due to the contribution of the $\Delta\Sigma$ Modulator. In order to obtain the fractional spurs level for a specific frequency offset outside the PLL bandwidth, the attenuation provided by the loop filter at such offset should be subtracted.
7. ΔT_{LOCK} expresses the temperature variation for which the device maintains locking condition when programmed at any operative temperature, provided that the initial and final T_{J} stays between $-40\text{ }^{\circ}\text{C}$ and the specified $T_{\text{J max}}$. No phase jump occurs when changing temperature while the device is in the locked condition (typical temperature change rate around $0.5\text{ }^{\circ}\text{C/min}$). Guaranteed by design and characterization.
For additional information please refer [Section 8.3: Robust VCO calibration over full temperature range](#).

8. ΔT_{LOCK} figures reported are given with CAL_TEMP_COMP (*ST6 Register*) set to '1' and under the following conditions:
When VCO core is supplied at 4.5V:
- For FVCO \leq 4500MHz VCALB_MODE (*ST4 Register*) MUST be set to '0'
- For FVCO > 4500MHz VCALB_MODE (*ST4 Register*) MUST be set to '1'
- CALB_3V3_MODE1 (*ST4 Register*) **must** be set to '0'
- CALB_3V3_MODE0 (*ST4 Register*) **must** be set to '0'.
- When VCO core is supplied at 3.3V:
- For any FVCO VCALB_MODE (*ST4 Register*) MUST be set to '1'
- CALB_3V3_MODE1 (*ST4 Register*) MUST be set to '1'
- CALB_3V3_MODE0 (*ST4 Register*) MUST be set to '1'.
- ΔT_{LOCK} data for VCO core supplied at 3.3 V are not available / applicable on product codes STuW81300-1T, STuW81300-1TR.
9. Includes VCO fundamental and higher order harmonics.
10. Current consumption measured with PLL locked in following conditions: Reference clock signal @ 100 MHz; PFD @ 50 MHz (R=2); VCO @ 4005 MHz.

Table 7. Phase noise specifications

Parameter ⁽¹⁾	Condition	Min	Typ	Max	Units
In-band phase noise floor					
Normalized in-band phase noise floor ⁽²⁾	I _{CP} =5 mA, PLL BW=150 kHz; including reference divider contribution	-	-227	-	dBc/Hz
VCO direct - Open Loop @ 3850 MHz					
Phase Noise @ 1 kHz	VCC_VCO_Core = 4.5 V	-	-62	-	dBc/Hz
Phase Noise @ 10 kHz		-	-92	-	dBc/Hz
Phase Noise @ 100 kHz		-	-114	-	dBc/Hz
Phase Noise @ 1 MHz		-	-135	-	dBc/Hz
Phase Noise @ 10 MHz		-	-153	-	dBc/Hz
Phase Noise @ 90 MHz		-	-160	-	dBc/Hz
VCO direct - Open Loop @ 6000 MHz					
Phase Noise @ 1 kHz	VCC_VCO_Core = 4.5 V	-	-57	-	dBc/Hz
Phase Noise @ 10 kHz		-	-87	-	dBc/Hz
Phase Noise @ 100 kHz		-	-110	-	dBc/Hz
Phase Noise @ 1 MHz		-	-131	-	dBc/Hz
Phase Noise @ 10 MHz		-	-150	-	dBc/Hz
Phase Noise @ 90 MHz		-	-158	-	dBc/Hz
VCO direct - Open Loop @ 8000 MHz					
Phase Noise @ 1 kHz	VCC_VCO_Core = 4.5 V	-	-56	-	dBc/Hz
Phase Noise @ 10 kHz		-	-84	-	dBc/Hz
Phase Noise @ 100 kHz		-	-107	-	dBc/Hz
Phase Noise @ 1 MHz		-	-128	-	dBc/Hz
Phase Noise @ 10 MHz		-	-147	-	dBc/Hz
Phase Noise @ 90 MHz		-	-157	-	dBc/Hz
VCO and frequency doubler- Open Loop @ 7700 MHz					
Phase Noise @ 1 kHz	VCC_VCO_Core = 4.5 V	-	-56	-	dBc/Hz
Phase Noise @ 10 kHz		-	-86	-	dBc/Hz
Phase Noise @ 100 kHz		-	-108	-	dBc/Hz
Phase Noise @ 1 MHz		-	-129	-	dBc/Hz
Phase Noise @ 10 MHz		-	-147	-	dBc/Hz
Phase Noise @ 90 MHz		-	-154	-	dBc/Hz

Table 7. Phase noise specifications (continued)

Parameter ⁽¹⁾	Condition	Min	Typ	Max	Units
VCO and frequency doubler- Open Loop @ 12 GHz					
Phase Noise @ 1 kHz	VCC_VCO_Core = 4.5 V	-	-51	-	dBc/Hz
Phase Noise @ 10 kHz		-	-81	-	dBc/Hz
Phase Noise @ 100 kHz		-	-104	-	dBc/Hz
Phase Noise @ 1 MHz		-	-125	-	dBc/Hz
Phase Noise @ 10 MHz		-	-144	-	dBc/Hz
Phase Noise @ 90 MHz		-	-154	-	dBc/Hz
VCO and frequency doubler - Open Loop @ 16 GHz					
Phase Noise @ 1 kHz	VCC_VCO_Core = 4.5 V	-	-50	-	dBc/Hz
Phase Noise @ 10 kHz		-	-78	-	dBc/Hz
Phase Noise @ 100 kHz		-	-101	-	dBc/Hz
Phase Noise @ 1 MHz		-	-122	-	dBc/Hz
Phase Noise @ 10 MHz		-	-141	-	dBc/Hz
Phase Noise @ 90 MHz		-	-154	-	dBc/Hz
VCO direct – Open loop @ 6 GHz					
Phase Noise @ 1 kHz	VCC_VCO_Core = 3.3 V	-	-55	-	dBc/Hz
Phase Noise @ 10 kHz		-	-84	-	dBc/Hz
Phase Noise @ 100 kHz		-	-107.5	-	dBc/Hz
Phase Noise @ 1 MHz		-	-128.5	-	dBc/Hz
Phase Noise @ 10 MHz		-	-148.5	-	dBc/Hz
Phase Noise @ 90 MHz		-	-158	-	dBc/Hz
VCO and frequency doubler – Open Loop @ 12 GHz					
Phase Noise @ 1 kHz	VCC_VCO_Core = 3.3 V	-	-49	-	dBc/Hz
Phase Noise @ 10 kHz		-	-78	-	dBc/Hz
Phase Noise @ 100 kHz		-	-101.5	-	dBc/Hz
Phase Noise @ 1 MHz		-	-122.5	-	dBc/Hz
Phase Noise @ 10 MHz		-	-142.5	-	dBc/Hz
Phase Noise @ 90 MHz		-	-155	-	dBc/Hz

1. SSB phase noise unless otherwise specified.
2. Normalized PN = Measured PN – 20log(N) – 10log(FPPD) where N is the VCO divider ratio and FPPD is the comparison frequency at the PFD input.

6 Typical performance characteristics

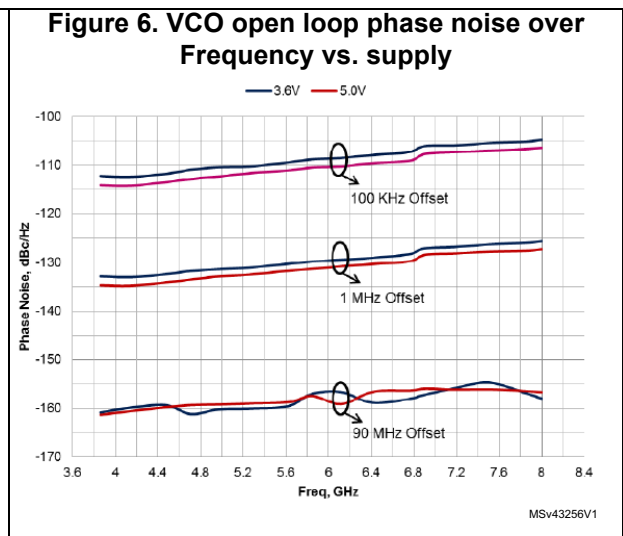
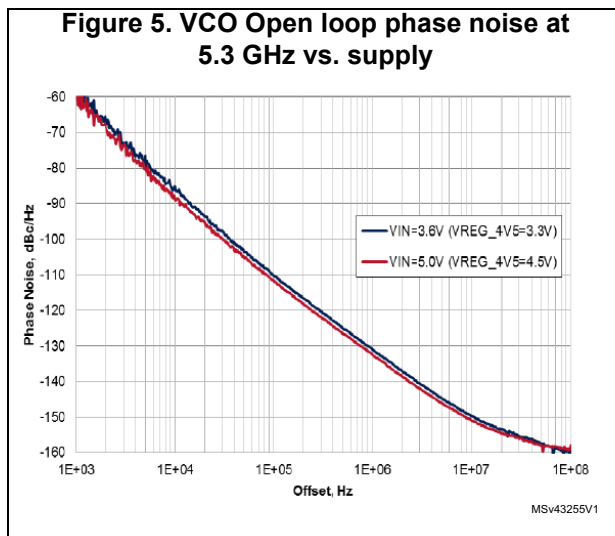
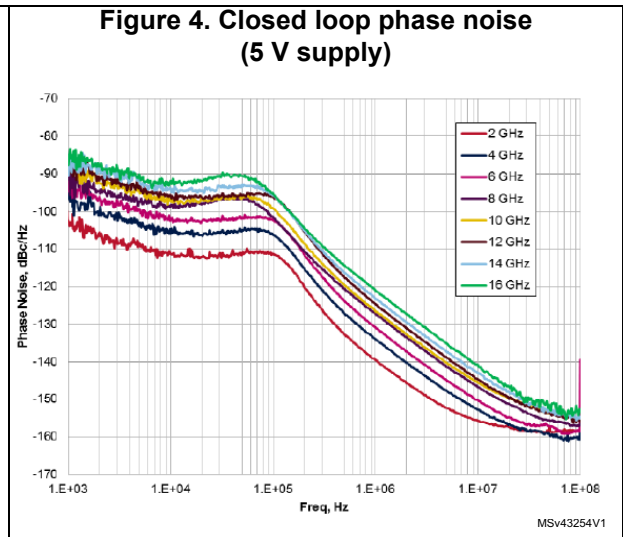
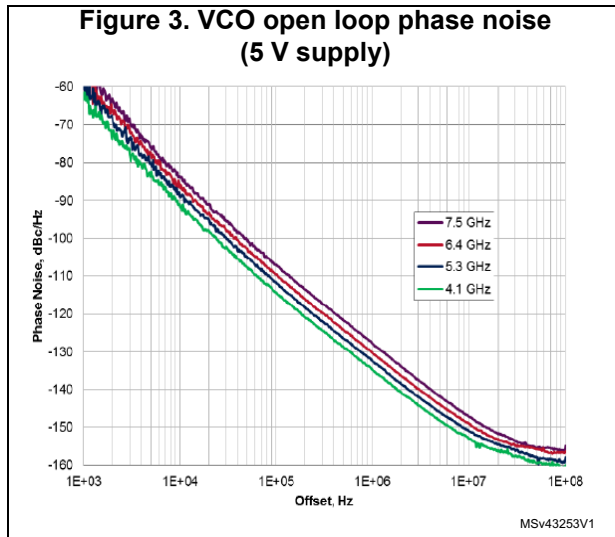
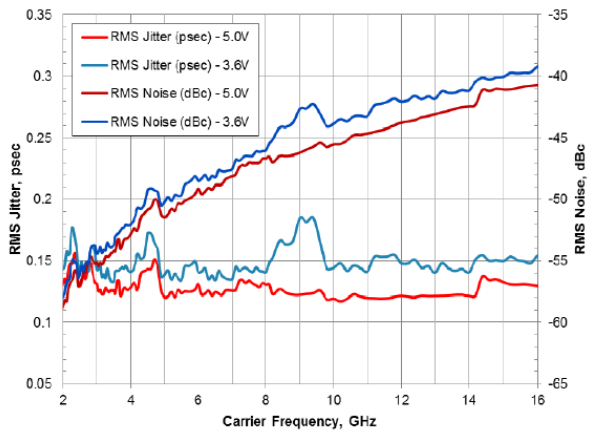
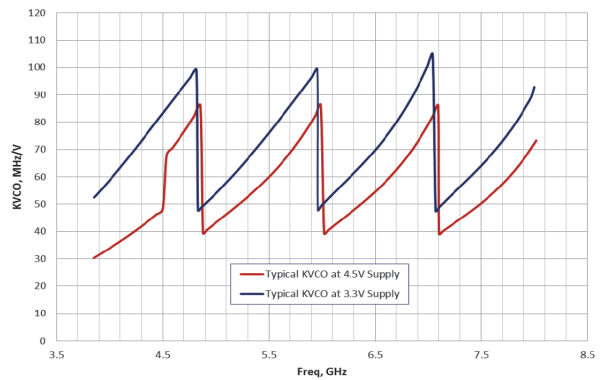

Figure 7. Single sideband integrated phase noise vs. frequency and supply ($F_{PFDD}=50$ MHz)



MSV43257V1

Figure 8. Average K_{VCO} over VCO frequency and supply



MSV43258V1

Figure 9. Phase noise and fractional spurs at 5952.5 MHz vs. supply ($F_{PFDD}=50$ MHz)

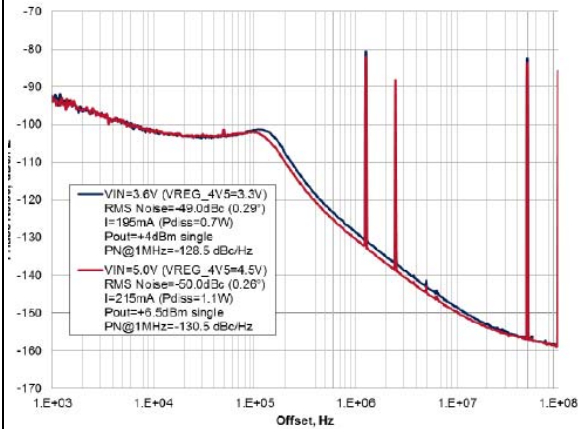

MSV43259V1

Figure 10. Phase noise and fractional spurs at 11502.5 MHz vs. supply ($F_{PFDD}=50$ MHz)

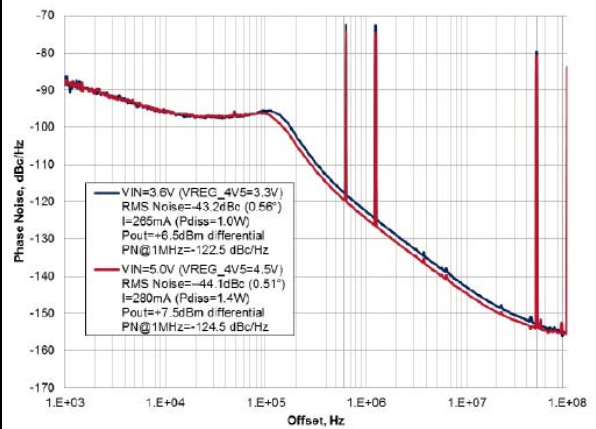

MSV43260V1

Figure 11. Output power level vs. temperature – RF1 output (5.0 V supply)

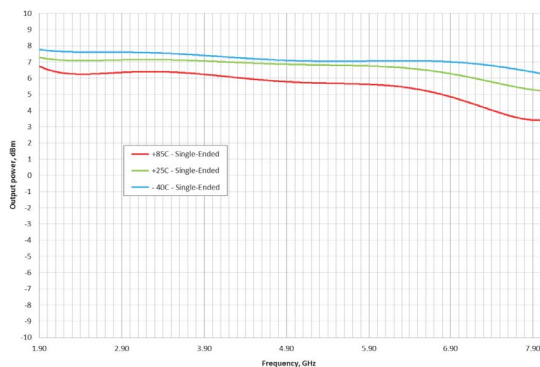

MSV43261V1

Figure 12. Output power level vs. temperature – RF2 output (5.0 V supply)

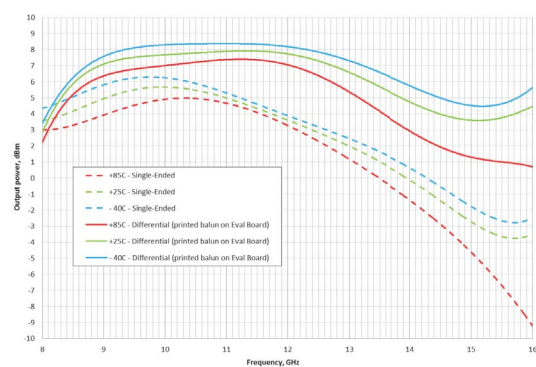

MSV43262V1

Figure 13. VCO feedthrough at RF2 output vs. fundamental VCO frequency

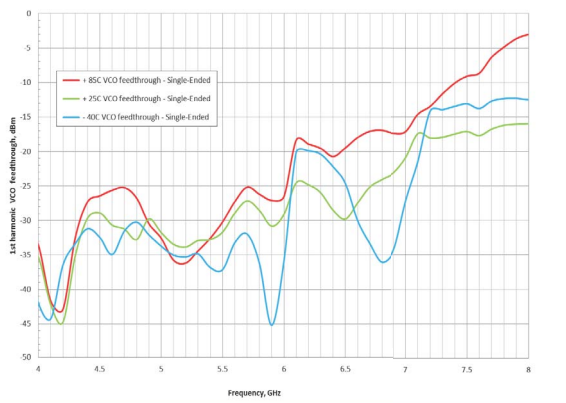

MSv43263V1

Figure 14. Typical spur level vs. offset from 12 GHz (5.0 V supply, $F_{PFD}=50$ MHz)

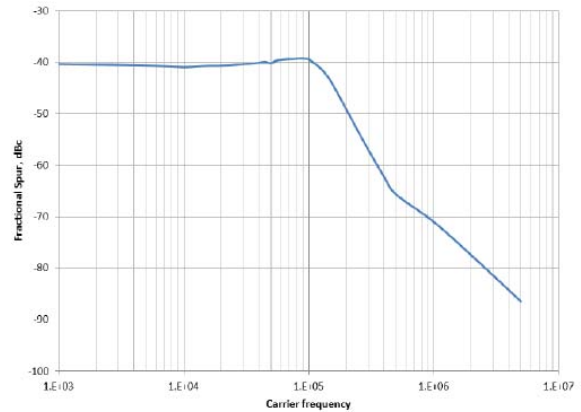

MSv43264V1

Figure 15. Typical spur level at PFD offset over carrier frequency (5.0 V supply)

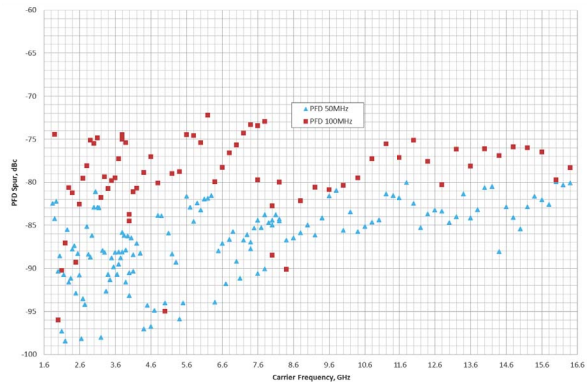

MSv43265V1

Figure 16. 10 kHz and 2.5 MHz fractional spur (integer boundary, 5.0 V supply, $F_{PFD}=50$ MHz)

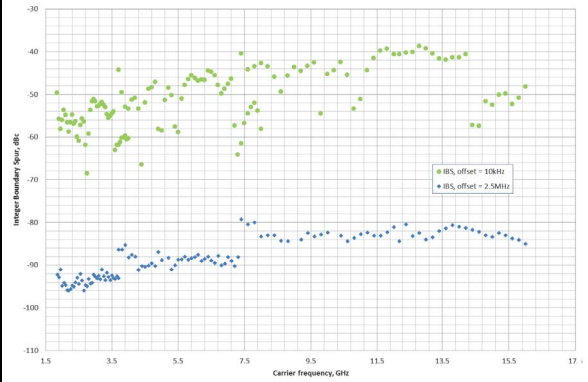

MSv43266V1

Figure 17. Frequency settling with VCO calibration – wideband view

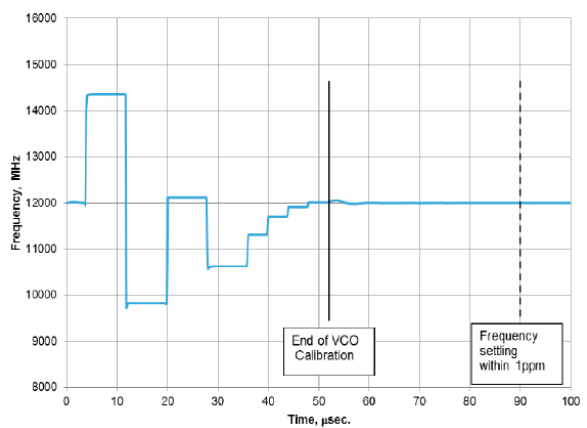

MSv43267V1

Figure 18. Frequency settling with VCO calibration – narrowband view

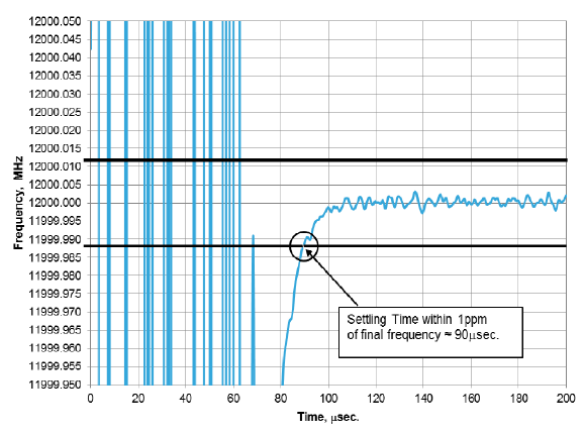

MSv43268V1

Figure 19. Overall current consumption vs. temperature (5.0 V supply, $F_{\text{PFD}}=50$ MHz)

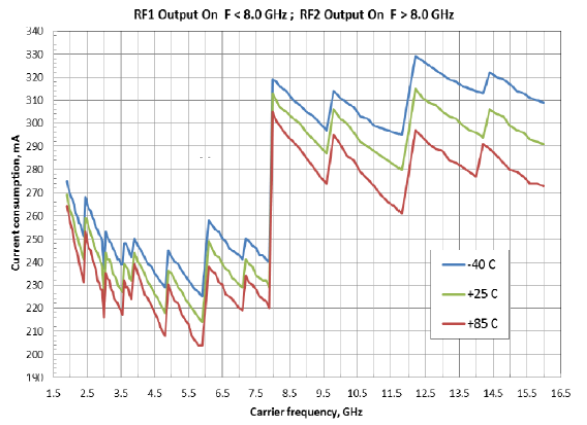

Figure 20. Overall current consumption vs. temperature (3.6 V supply, $F_{\text{PFD}}=50$ MHz)

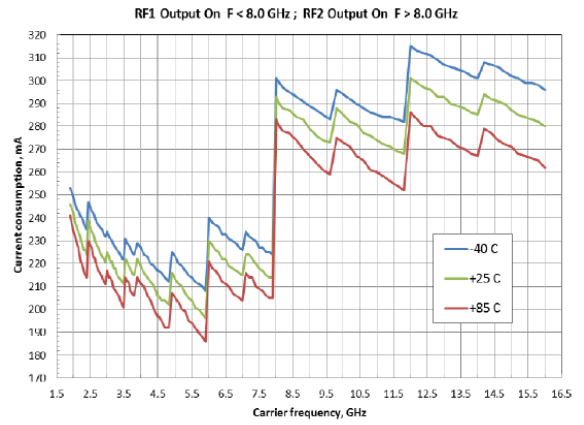
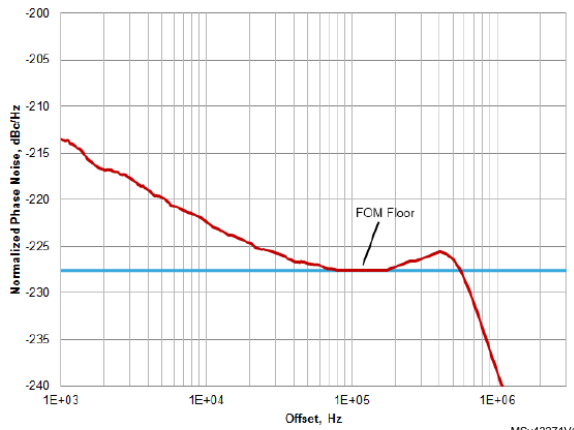

Figure 21. Figure of merit



7 Circuit description

7.1 Reference input stage

The reference input stage supports the use of different modes for the reference clock signal.

Both single-ended and differential modes (LVDS, LVECPL) are supported; a crystal mode is also provided in order to build a Pierce type crystal oscillator. [Figure 22](#) shows the connections required for the supported configurations.

In single-ended and differential modes, the inputs must be AC coupled as the REF_CLKP and REF_CLKN pins are internally biased to an optimal DC operating point. The best phase-noise performance is obtained for signals with a high slew rate, such as a square wave.

Figure 22. Reference clock buffer configurations: single-ended (A), differential (B), crystal mode (C)

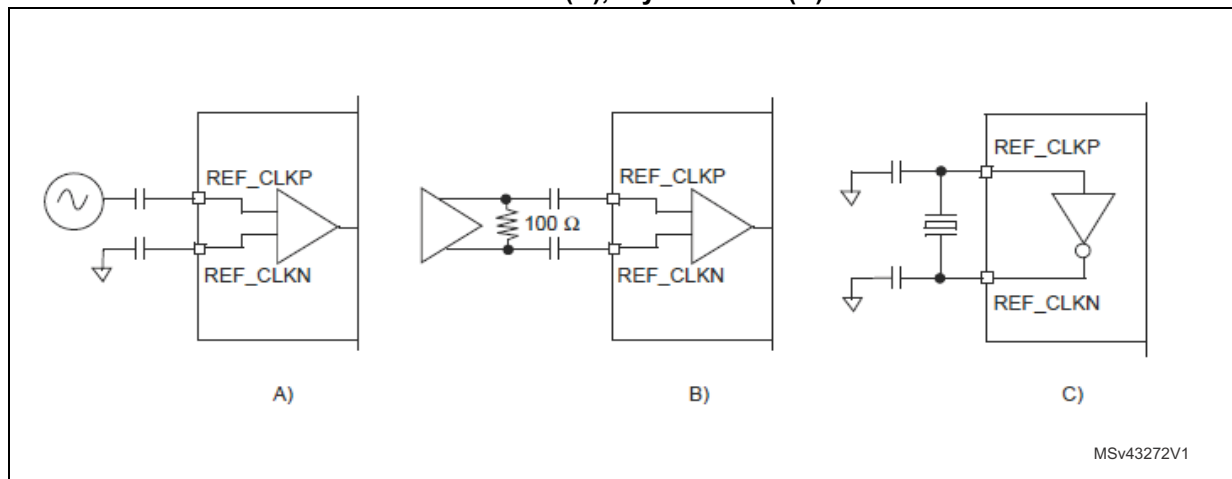

7.2 Reference divider

The 13-bit programmable reference counter divides the input reference frequency to the desired PFD frequency. The division ratio is programmable from 1 to 8191.

The maximum allowable input frequency of the R-Counter is 200 MHz.

The reference clock frequency can be extended up to 400 MHz by enabling the divide-by-2 stage or up to 800 MHz by enabling the divide-by-4 stage.

A frequency doubler is provided in order to double low reference frequencies and increase the PFD operating frequency, thus allowing easier filtering of the out-of-band noise of the Delta-Sigma Modulator. The doubler introduces a noise degradation in the in-band PLL noise, so this feature should be used with care.

When the doubler is enabled, the maximum reference clock frequency is limited to 25 MHz, leading to a maximum PFD frequency of 50 MHz.

7.3 PLL N divider

The N divider sets the division ratio in the PLL feedback path.

Both Integer-N and Fractional-N PLL architectures are implemented in order to ensure the best overall performance of the synthesizer.

The Fractional-N division is achieved by combining the integer divider section with a Delta-Sigma modulator (DSM), which sets the fractional part of the overall division ratio.

The DSM is implemented as a MASH structure with programmable order (2 bit; 1st, 2nd, 3rd and 4th order), programmable MODULUS (21 bit).

It also includes a DITHERING function (1 bit), which can be used to reduce fractional spur tones by spreading the DSM sequence and consequently the energy of the spurs over a wider bandwidth.

The overall division ratio, N is given by:

$$N = N_{INT} + N_{FRAC}$$

The integer part N_{INT} is 17-bit programmable and can range from 24 to 131071 in Integer Mode. For $N_{INT} \geq 512$ the fractional mode is not allowed and the setting used for DSM has no effect.

Based upon the selected order of the Delta-Sigma modulator the allowed range of N_{INT} values changes as follows:

- 24 to 510 - 1st Order DSM
- 25 to 509 - 2nd Order DSM
- 27 to 507 - 3rd Order DSM
- 31 to 503 - 4th Order DSM

The fractional part N_{FRAC} of the division ratio is controlled by setting the values FRAC and MOD (21 bits each). It also depends on the value of DITHERING (1 bit):

$$N_{FRAC} = \frac{FRAC}{MOD} + \frac{DITHERING}{2 \cdot MOD}$$

The MOD value can range from 2 to 2097151, while the range of FRAC is from 0 to MOD-1. If the DITHERING function is not used (DITHERING=0) the fractional part of N is simply derived as the ratio FRAC over MOD.

The resulting VCO frequency is:

$$F_{VCO} = \frac{F_{ref}}{R} \cdot N = \frac{F_{ref}}{R} \cdot \left(N_{INT} + \frac{FRAC}{MOD} + \frac{DITHERING}{2 \cdot MOD} \right)$$

where:

F_{VCO} is the output frequency of VCO

F_{ref} is the input reference frequency

R is the division ratio of reference chain

N is the overall division ratio of the PLL

The N divider accepts input signal frequencies up to a maximum of 6 GHz. When the setup requires a VCO frequency greater than 6 GHz, the VCO signal provided to the N divider must be divided by 2 by setting PLL_SEL='1' in the [ST1 Register](#). In this case the VCO frequency is fixed by:

$$F_{VCO} = \frac{F_{ref}}{R} \cdot 2 \cdot \left(N_{INT} + \frac{FRAC}{MOD} + \frac{DITHERING}{2 \cdot MOD} \right)$$

The implementation with programmable modulus allows the user to easily select the desired fraction and the exact synthesized frequency with no approximation.

The MOD value can be set to very high values, thus the frequency resolution of the synthesizer can reach very fine steps (down to a few hertz).

A 'low spur mode' could be configured by maximizing both FRAC and MOD values, keeping the same desired FRAC/MOD ratio, and setting the DITHERING bit to '1'. The drawback is a small frequency error, equal to $F_{PFD}/(2 \cdot MOD)$ on the synthesized frequency. This error is in the range of a few hertz (usually tolerated by most applications).

7.4 Fractional spurs and compensation mechanism

The fractional PLL operation generates unwanted fractional spurs around the synthesized frequency.

The *integer boundary spurs* occur when the carrier frequency is close to an integer multiple of the PFD frequency. If the frequency difference between the carrier and the $N \cdot F_{PFD}$ falls within the PLL loop bandwidth, the integer boundary spur is unfiltered and represents the worst-case situation giving the highest spur level.

The *channel spurs* are generated by the delta-sigma modulator operations and depend on its settings (they are mainly related to the MOD value). The channel spurs appear at a frequency offset from the carrier, equal to F_{PFD}/MOD and its harmonics, and they are not integer boundary. If the MOD value is extremely high (close to the maximum value of $2^{21}-1$) the channel spur offset is of the order of a tenth of a hertz and it appears as 'granular noise' shaped by the PLL around the carrier.

The STuW81300 provides the user with three different mechanisms to compensate fractional spurs: *PFD delay mode*, *charge pump leakage current* and *down-split current*. These features should be adopted case-by-case as they give different spur-level results depending on setup conditions (reference clock frequency, PFD frequency, DSM setup, VCO frequency, carrier frequency, charge pump current, VCO/charge pump supply voltage).

7.4.1 PFD delay mode

The STuW81300 implements two different programmable delay lines in the reset path of the main flip-flop of the PFD. This allows different delay reset values to be set for the VCO divided path and reference-clock divided path. Hence an offset value can be forced on the PFD and charge-pump characteristics far enough from the zero to guarantee that the whole circuit works in a linear region.

It is possible to set the sign of the delay through the PFD_DEL_MODE bit in the [ST3 Register](#) (no delay, VCO_DIV_delayed or REF_DIV_delayed). The delay value can be set through the PFD_DEL bit in the [ST0 Register](#) (2 bit; 0=1.2 ns, 1=1.9 ns, 2=2.5 ns, 3=3.0 ns). Even though the spur-compensation settings are best optimized case-by-case, the setup 'VCO_DIV_delayed + 1.2 ns delay' is strongly recommended for most conditions.

7.4.2 Charge pump leakage current

A different way to force an offset value on the PFD+CP characteristics is provided within the STuW81300 by sourcing or sinking a DC leakage current from the charge pump (settings available in the [ST3 Register](#)). The leakage current is 5-bit programmable, starting from a base DC current of 10 μA (it can be doubled to 20 μA by setting bit CP_LEAK_x2 = 1b). The sign is set by the CP_LEAK_DIR bit: 0b = down-leakage (sink), 1b = up-leakage (source).

The resulting delay offset is calculated as follows:

$$\text{delay} = \frac{I_{\text{LEAK}}}{F_{\text{PFD}} \cdot I_{\text{CP}}}$$

Experimental results show that down-leakage currents are more effective than up-leakage. The user must be aware that the use of the leakage current might impact the overall phase noise performance by increasing the charge pump noise contribution.

7.4.3 Down-split current

This mechanism is enabled through the DNSPLIT_EN bit ([ST3 Register](#)). It uses the injection of a down-split current pulse from the charge pump circuit. The current pulse is 16 VCO cycles wide while the current level is set by the PFD_DEL bit ([ST0 Register](#)) among 4 different possible values: 0, 0.25 \cdot I_{CP}, 0.5 \cdot I_{CP} or 0.75 \cdot I_{CP}.

7.5 Phase frequency detector (PFD)

The PFD takes inputs from the reference and the VCO dividers and produces an output proportional to the phase error. The PFD includes a delay gate that controls the width of the anti-backlash pulse (1.2 to 3 ns). This pulse ensures that there is no dead zone in the PFD transfer function.

Figure 23 shows a simplified schematic of the PFD.

Figure 23. PFD diagram

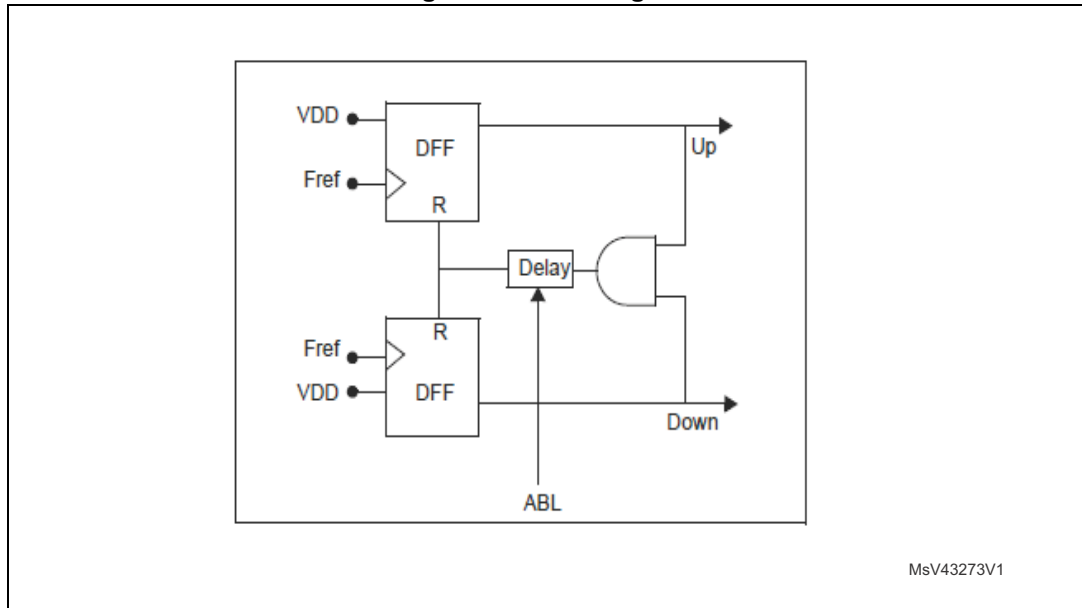

7.6 Lock detect

The lock detector indicates the lock state for the PLL. The lock condition is detected by comparing the UP and DOWN outputs of the digital Phase Frequency Detector.

A CMOS logic output signal indicates the lock state. The polarity of the output signal can be inverted using the LD_ACTIVELOW bit.

The lock condition occurs when the delay between the edges of UP and DOWN signals is lower than a specific value (3-bit programmable from 2 ns to 16 ns) and this condition is stable for a specific number of consecutive PFD cycles (3-bit programmable counter from 4 to 4096 cycles).

This extreme flexibility is needed for the lock detector circuitry to work properly with all possible PLL setups (Integer-N, Fractional-N, different PFD frequencies and so on).

7.7 Charge pump

This block consists of two matched current sources, I_{up} and I_{down} , which are controlled respectively by the UP and DOWN PFD outputs. The nominal value of the output current (I_{CP}) is controlled by selecting one of 32 values by a 5-bit word.

The minimum value of the output current (I_{CP}) is 158 μ A.

The charge pump also includes compensation circuitry to take into account variation of K_{VCO} with VCO control voltage, which changes with temperature and process for a specified frequency. The K_{VCO} compensation block adjusts the nominal I_{CP} value, minimizing the variation of the product $I_{CP} \times K_{VCO}$ to keep the PLL bandwidth constant for the specified frequency. In order to compensate the change of K_{VCO} with frequency, the user should manually adjust the I_{CP} value to keep the PLL bandwidth constant.

In addition, the charge-pump output stage can operate with a 3.3 V to 4.5 V supply voltage. The LDO_4V5, programmable at 3.3 V and 4.5 V can be used for this purpose.

Table 8. Current value versus selection

CPSEL4	CPSEL3	CPSEL2	CPSEL1	CPSEL0	Current	Value
0	0	0	0	0	-	0
0	0	0	0	1	I_{MIN}	158 μ A
0	0	0	1	0	$3 \cdot I_{MIN}$	316 μ A
...
1	1	1	0	1	$29 \cdot I_{MIN}$	4.58 mA
1	1	1	1	0	$30 \cdot I_{MIN}$	4.74 mA
1	1	1	1	1	$31 \cdot I_{MIN}$	4.9 mA

7.8 Fast lock mode

The fast-lock feature can be enabled to trade fast settling time against spurs rejection, performance parameters which generally require different settings of PLL bandwidth (narrow for better spurs rejection and wide for fast settling time).

A narrow bandwidth for low spurs can be designed for the lock state while a wide bandwidth can be designed for the PLL transients.

The wide bandwidth is achieved during the transient by increasing the charge pump current and reducing accordingly the dumping resistor value of the loop filter in order to keep the phase margin of the PLL constant. The duration of the PLL wide band mode, in terms of number of PFD cycles, is set by programming the fast-lock 13 bit counter.

7.9 Cycle slip reduction

The use of high $F_{\text{PFD}}/\text{PLL_BW}$ ratios may lead to an increased settling time due to cycle slips.

A cycle slip compensation circuit is provided which automatically increases the charge pump current for high-frequency errors and restores the programmed value at the end of the locking phase.

7.10 Voltage controlled oscillators (VCOs)

The STuW81300 employs four low-noise VCOs with monolithic LC tanks to cover a frequency range from 3850 MHz to 8000 MHz. Combined with an on-chip frequency doubler and divide-by-two stage, the VCOs allow synthesis of any frequency across the 1.925 GHz to 16 GHz range.

Each VCO is implemented using a structure with multiple sub-bands to maintain a low VCO sensitivity (K_{VCO}), resulting in low phase noise and low spurs performance.

The correct VCO and sub-band selection is automatically performed by dedicated digital circuitry (clocked by the PFD) every time a new frequency is programmed. The VCO auto-calibration procedure is activated once the [ST0 Register](#) is updated.

During the selection procedure the VCTRL of the VCO is charged to a fixed reference voltage. A stable reference clock signal to the device must present before the VCO calibration begins. The procedure for the VCO and sub-band selection takes approximately 13 CALB_{CLK} cycles.

The calibrator clock frequency is linked to PFD frequency ($\text{CALB}_{\text{CLK}} = F_{\text{PFD}}/\text{CALDIV}$) and should be adjusted in order to achieve correct operations. The maximum allowed frequency is 250 kHz, therefore the calibrator divider ratio (CALDIV, [ST6 Register](#)) must be set accordingly.

When the PLL is configured in Integer mode only ($N_{\text{INT}} \geq 512$, see [Section 7.3: PLL N divider](#)) the calibrator divider should be by-passed (CALDIV = 1). In such a case, if the setup of the application requires a PFD frequency higher than 250 kHz the calibration procedure must be executed in two steps as follows:

1. **VCO calibration.** Configure all the device registers (see [Section 7.18: Example register programming](#)) making sure to program the desired VCO frequency with proper settings of the values N ([ST0 Register](#)) and R ([ST3 Register](#)) so that F_{PFD} is ≤ 250 kHz.
2. **Final operating setup.** Adjust the values N and R properly in order to program the device with the desired setup configuration (VCO and PFD frequency) setting also the VCO_CALB_DISABLE bit set to '1' ([ST0 Register](#)).

The above limitation of $\text{CALB}_{\text{CLK}} \leq 250$ kHz is valid for those applications which require the PLL to stay in lock to the same frequency for a long time (experiencing a significant temperature drift) without any user action. In such a case the calibration procedure must select the optimal pair VCO/WORD able to guarantee the PLL lock condition over a temperature drift defined by the ΔT_{LOCK} parameter (see [Section 8.3: Robust VCO calibration over full temperature range](#)).

If the application requires a continuous hopping among different frequencies the maximum allowed CALB_{CLK} is increased up to 1 MHz (valid for both fractional and Integer-only modes). In this case the VCO calibration procedure, required for each VCO frequency

change, is performed in a very short time (~13 ms) minimizing the impact on the overall PLL switching time.

Once the correct VCO and sub-band are selected the normal PLL operations are resumed.

The VCO core can be supplied (pin#3) from 3.3 V to 4.5 V; the LDO_4V5 (programmable to 4.5 V and 3.3 V) is used for this purpose. Furthermore, the amplitude of oscillation, which trades current consumption with phase-noise performance is 3-bit programmable ([ST4 Register](#), VCO_AMP bit). [Section 7.16: STuW81300 register descriptions](#) shows the allowed ranges of the oscillation amplitude for each available supply setting. In order to achieve the best phase-noise performance, the maximum allowed amplitude setting is recommended.

VCO calibration auto-restart feature

The VCO calibration auto-restart feature, once activated, allows the calibration procedure to be restarted when an event that moves the PLL into an unlock condition has occurred (trigger on '1' to '0' transition of the lock detector signal).

This feature can be enabled through the EN_AUTOCAL bit ([ST6 Register](#)) and requires proper setting of the lock detector parameters (LD_PREC and LD_COUNT, [ST4 Register](#)), in order to avoid any unwanted transition of the lock detector signal during the transient time required by the PLL to lock the VCO at the desired frequency.

Note: This feature is not available on product code STUW81300-1T, STUW81300-1TR.

7.11 RF output stage

The VCO output signal can be fed either to an RF output buffer or to a monolithic frequency doubler, followed by a microwave output buffer.

The on-chip frequency multiplier allows the STuW81300 to cover a 7.7 GHz to 16 GHz frequency range with high fundamental harmonic rejection.

The STuW81300 employs two different 100-ohm differential (50-ohm single-ended) internally-matched broadband output stages, simplifying the design of the final application and reducing the number of external components.

A first RF output stage buffer (pins RF1_OUTP, RF1_OUTN) supports the 1925 MHz to 4000 MHz (using the divider-by-2 path) and 3850 MHz to 8000 MHz frequency ranges providing +6 dBm of output power @6 GHz into a 50-ohm single-ended resistive load.

The output stage buffer can be powered-down by software and/or hardware (pin PD_RF1).

A secondary microwave output stage (available on pins RF2_OUTP and RF2_OUTN) is also provided to deliver the VCO frequency-doubled signal (7.7 GHz-to-16 GHz) and is able to provide +4 dBm @12 GHz into a 50-ohm single-ended resistive load. This second output stage can also be powered down by software and/or hardware (pin PD_RF2).

An RF mute function, which allows RF output stages to be kept OFF until the PLL achieves lock status, can be selected by software.

The simultaneous use of both RF outputs (RF1 and RF2) is not supported. The user should configure the power down bit of the RF output stage so as to avoid enabling both RF outputs at the same time.

7.12 Low-power functional modes

All the performance characteristics defined in the electrical specifications are achieved in full current mode. The STuW81300 provides a set of low power functional modes to allow control of the current consumption of the different blocks.

This feature combined with the use of a 3.3 V regulated voltage for pins #3, 16, 32, can be helpful for applications requiring low power consumption. The power saving modes trade the current consumption with the phase-noise performance and/or output level.

7.13 LDO voltage regulators

Low drop-out (LDO) voltage regulators are integrated to provide the synthesizer with stable supply voltages against input voltage (VIN), load and temperature variations. Five regulators are included to ensure proper isolation among circuit blocks. These regulators are listed below along with the target specifications for the regulated output voltage (Vreg) and current capability:

- LDO_DIG (to supply the digital circuitry),
Vreg = 2.6 V, I_{max} = 50 mA, VIN range: 3.0 to 5.4 V
- LDO_PLL (to supply the PLL),
Vreg = 2.6 V, I_{max} = 50 mA, VIN range: 3.0 to 5.4 V
- LDO_RF (to supply the RF blocks),
Vreg = 2.6 V, I_{max} = 100 mA, VIN range: 3.0 to 5.4 V
- LDO_VCO (to supply the low-voltage VCO sub-blocks):
Vreg = 2.6 V, I_{max} = 100 mA, VIN range: 3.0 to 5.4 V
- LDO_4V5 (to supply high-voltage sub-blocks):
Vreg = 4.5 V and 3.3 V programmable, I_{max} = 150 mA
VIN range: 3.6 to 5.4 V (when Vreg = 3.3 V)
VIN range: 5.0 to 5.4 V (when Vreg=4.5 V)

Proper stability and frequency response are achieved by connecting 10 µF load capacitors at the regulated output pins. The optimal configuration is achieved by connecting a small resistor in series with the capacitor in order to guarantee the controlled ESR required to ensure the proper phase margin, together with the best performance in terms of noise and PSRR. For a complete view of required connections and component values associated with the LDO output pins, see the related PCB schematics section available from the STuW81300 product page on the ST website.

Very-low noise requirements have been assumed for the design of the VCO-related regulators (LDO_VCO and LDO_4V5). To comply with the noise specifications, these LDOs exploit an additional external bypass (feed forward) capacitor of 100 nF.

All LDOs include over-current protection to avoid short-circuit failures, as well as internal power ramping to minimize startup current peaks.

All LDOs operate from a reference voltage of 1.35 V, which is internally generated by an integrated band-gap circuit and noise-filtered through an external 10 µF capacitor.

7.14 STuW81300 register programming

The STuW81300 has 12 registers (10 R/W + 2 Read-Only) programmed through an SPI digital interface. The protocol uses 3 wires (SDI, SCK, LE) for write mode plus an additional pin (LD_SDO) for read operation. Each register has 32 bits, one for Read/Write mode selection, 4 address bits and 27 data bits.

Figure 24. SPI Protocol

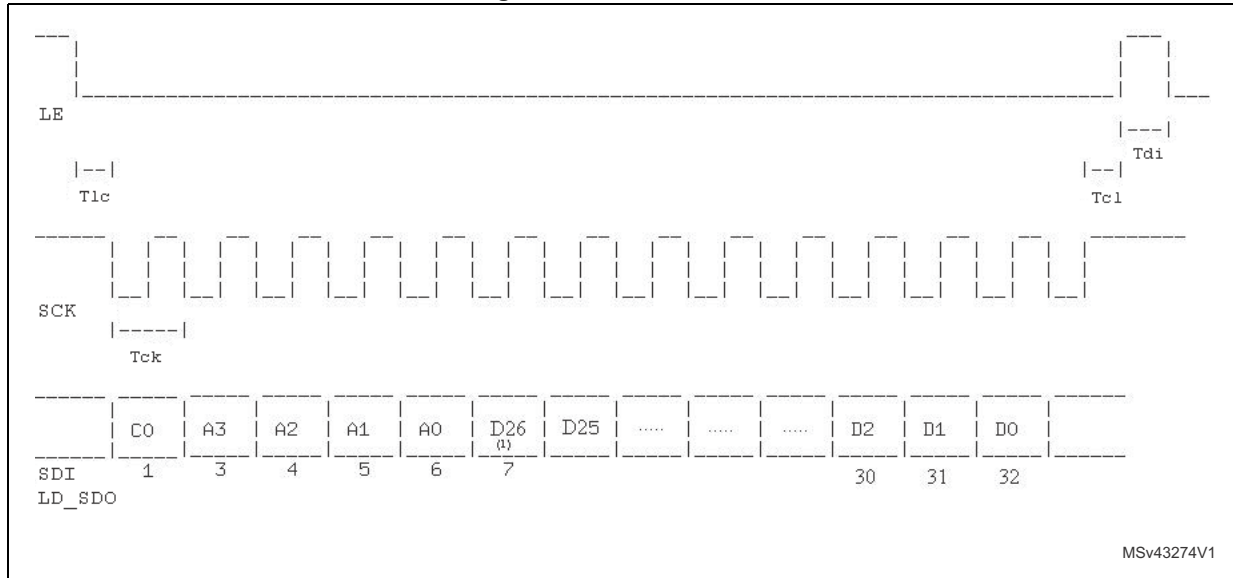

1. Bit for double buffering used for some registers only.

The Data bits are stored in the internal shift register on the rising edge of SCK.

The first bit, CO is used for mode selection (0=Write Operation, 1=Read Operation). The bits A[3:0] represent the register address, and D[26:0] are the data bits.

In some registers, the first data bit, D26, is used (when set to '1') for double-buffering purposes. In this case the register content is stored in a temporary buffer and is transferred to the internal register once a write operation is done on the master register ST0.

Figure 25. SPI timing diagram

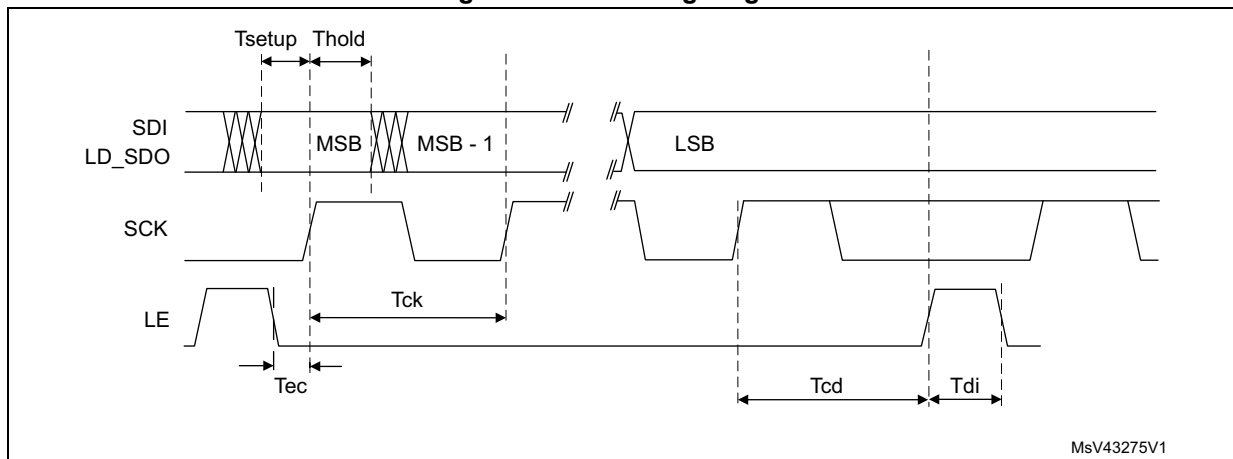

MsV43275V1

Table 9. SPI timings

Parameter	Comments	Min	Typ	Max	Unit
Tsetup	data to clock setup time	4	-	-	ns
Thold	data to clock hold time	1	-	-	ns
Tck	clock cycle period	20	-	-	ns
Tdi	disable pulse width	4	-	-	ns
Tcd	clock-to-disable time	1	-	-	ns
Tec	enable-to-clock time	3	-	-	ns

7.15 STuW81300 register summary

Table 10. SPI Register map (address 12 to 15 not available)

Address	Register Name	Type	Description	Page
0x00	ST0 Register	Read/Write	Master register. N divider, CP current. Writing to this register starts a VCO calibration	on page 36
0x01	ST1 Register	Read/Write Double-Buffered	FRAC value, RF1 output control	on page 37
0x02	ST2 Register	Read/Write Double-Buffered	MOD value, RF2 output control	on page 38
0x03	ST3 Register	Read/Write Double-Buffered	R divider, CP leakage, CP down-split pulse, Ref. Path selection, Device power down	on page 39
0x04	ST4 Register	Read/Write	Lock det. control, Ref. Buffer, CP supply mode, VCO settings, Output power control	on page 41
0x05	ST5 Register	Read/Write	Low power mode control bit	on page 43
0x06	ST6 Register	Read/Write	VCO Calibrator, Manual VCO control, DSM settings	on page 44
0x07	ST7 Register	Read/Write	Fast Lock control, LD_SDO settings	on page 46
0x08	ST8 Register	Read/Write	LDO Voltage Regulator settings	on page 47
0x09	ST9 Register	Read/Write	Reserved (Test and Initialization bit)	on page 48
0x0A	ST10 Register	Read Only	VCO, Lock det. Status, LDO status	on page 49
0x0B	ST11 Register	Read Only	Device ID	on page 50

7.16 STuW81300 register descriptions

ST0 Register

	26	25	24	23	22	21	20	19	18	17	16	15	14	13	12	11	10	9	8	7	6	5	4	3	2	1	0
VCO_CALB_DISABLE	CP_SEL[4:0]				PFD_DEL[1:0]		RESERVED	RESERVED	N[16:0]																		
W	RW				RW		RW	RW	RW																		

Address: STuW81300BaseAddress + 0x00

Type: R/W

Description: Master register. N divider, CP current

[26] VCO_CALB_DISABLE:

Must be set to '0'

1: disable the VCO calibrator (Note: this bit is of type write-only and cannot be read. A read operation always returns 1)

[25:21] CP_SEL: set charge pump pulse current value (0 to 4.9 mA; step ~158 μ A)

00000: (0) set $I_{CP}=0$

00001: (1) set $I_{CP}=158 \mu$ A

00010: (2) set $I_{CP}=316 \mu$ A

...

11110: (30) set $I_{CP}=4.74$ mA

11111: (31) set $I_{CP}=4.90$ mA

[20:19] PFD_DEL: set PFD anti-backlash delay / down-split current value

00: (0) 1.2 ns / 0 A (default)

01: (1) 1.9 ns / $0.25 \cdot I_{CP}$

10: (2) 2.5 ns / $0.5 \cdot I_{CP}$

11: (3) 3.0 ns / $0.75 \cdot I_{CP}$

[18] RESERVED: must be set to '0'

[17] RESERVED: must be set to '0'

[16:0] N: Set integer part of N divider ratio (N_{INT})

For $N_{INT} \geq 512$, fractional mode is not allowed (FRAC and MOD settings are ignored)

ST1 Register

26	25	24	23	22	21	20	19	18	17	16	15	14	13	12	11	10	9	8	7	6	5	4	3	2	1	0
DBR	RESERVED	RF1_OUT_PD	MAN_CALB_EN	PLL_SEL	RF1_SEL	FRAC[20:0]																				
RW	RW	RW	RW	RW	RW	RW																				

Address: STuW81300BaseAddress + 0x01

Type: R/W

Applicability: Double buffered (based upon DBR bit setting)

Description: FRAC value, RF1 output control

- [26] DBR: double buffering bit enable
1: the register is buffered and transferred only once the master register ST0 is written
- [25] RESERVED: must be set to '0'
- [24] RF1_OUT_PD: RF1 output power down
0: RF1 output enabled
1: RF1 output disabled
- [23] MAN_CALB_EN: enables manual VCO calibrator mode
0: automatic VCO calibration (VCO_SEL, VCO_WORD settings are ignored)
1: manual VCO calibration (VCO_SEL, VCO_WORD settings are used; VCO calibration procedure is inhibited; VCO_SEL and VCO_WORD bit to be set in ST6 Register)
- [22] PLL_SEL: selection of the signal path to PLL
0: VCO direct to PLL
1: VCO divided by 2 to PLL (mandatory for VCO freq > 6 GHz; in such a case the overall N value is doubled and N_{INT},FRAC and MOD must be updated accordingly at the half value)
- [21] RF1_SEL: RF1 output divider selection
0: VCO direct
1: VCO divided by 2
- [20:0] FRAC: Fractional value bit; set the numerator value of the fractional part of the overall division ratio (N=N_{INT}+FRAC/MOD)
Range: 0 to 2097151 (must be < MOD)

ST2 Register

26	25	24	23	22	21	20	19	18	17	16	15	14	13	12	11	10	9	8	7	6	5	4	3	2	1	0
DBR		DSM_CLK_DISABLE		RESERVED			RF2_OUT_PD		MOD[20:0]																	
RW		RW		RW			RW		RW																	

Address: STuW81300BaseAddress + 0x02

Type: R/W

Applicability: Double buffered (based upon DBR bit setting)

Description: MOD value, RF2 output control

- [26] DBR: Double buffering bit enable; at '1' the register is buffered and transferred only once the master register ST0 is written
- [25] DSM_CLK_DISABLE: for test purposes only. Must be set to '0'
- [24:22] RESERVED: must be set to '0'
- [21] RF2_OUT_PD: RF2 output power down
 - 0: RF2 output enabled
 - 1: RF2 output disabled (RF2 output must be disabled if RF1 output is enabled)
- [20:0] MOD: Modulus value bit; set the denominator value of the fractional part of the overall division ratio ($N=N_{INT}+FRAC/MOD$)
 - Allowed setting range: 2 to 2097151

ST3 Register

26	25	24	23	22	21	20	19	18	17	16	15	14	13	12	11	10	9	8	7	6	5	4	3	2	1	0
DBR		PD	CP_LEAK_x2	CP_LEAK[4:0]				CP_LEAK_DIR	DNSPLIT_EN	PFD_DEL_MODE[1:0]		REF_PATH_SEL[1:0]		R[12:0]												
RW		RW	RW	RW				RW	RW	RW		RW		RW												

Address: STuW81300BaseAddress + 0x03

Type: R/W

Applicability: Double buffered (based upon DBR bit setting)

Description: R divider, CP leakage, CP down-split pulse, Ref. Path selection, Device power down

[26] DBR: Double buffering bit enable; at '1' the register is buffered and transferred only once the master register ST0 is written

[25] PD: device power down; at '1' put OFF all blocks (except LDOs)

[24] CP_LEAK_x2: double Charge Pump leakage current bit
 0: set standard leakage current (10 μ A step)
 1: set doubled leakage current (20 μ A step)

[23:19] CP_LEAK: Set Charge Pump leakage current value (0 to 620 μ A; step 10 μ A or 20 μ A base upon CP_LEAK_x2 setting)

00000: (0) set $I_{LEAK} = 0$ (default)

00001: (1) set $I_{LEAK} = 10 \mu$ A ($I_{LEAK} = 20 \mu$ A if CP_LEAK_x2 = 1)

00010: (2) set $I_{LEAK} = 20 \mu$ A ($I_{LEAK} = 40 \mu$ A if CP_LEAK_x2 = 1)

...

11110: (30) set $I_{LEAK} = 300 \mu$ A ($I_{LEAK} = 600 \mu$ A if CP_LEAK_x2 = 1)

11111: (31) set $I_{LEAK} = 310 \mu$ A ($I_{LEAK} = 620 \mu$ A if CP_LEAK_x2 = 1)

[18] CP_LEAK_DIR: set direction of the leakage current

0: set down-leakage (current sink)

1: set up-leakage (current source)

[17] DNSPLIT_EN: at '1' enables down-split pulse current; current level set by PFD_DEL[1:0] in register ST0

- [16:15] PFD_DEL_MODE: set PFD delay mode; delay values set by PFD_DEL[1:0] in register ST0
- 00: (0) no delay (default)
 - 01: (1) VCO_DIV delayed
 - 10: (2) REF_DIV delayed
 - 11: (3) Reserved
- [14:13] REF_PATH_SEL: reference clock path selection
- 00: (0) Direct
 - 01: (1) Doubled in single mode; Not Applicable in differential mode
 - 10: (2) Divided by 2
 - 11: (3) Divided by 4
- [12:0] R: set Reference clock divider ratio (allowed setting range 1 to 8191)

ST4 Register

26	25	24	23	22	21	20	19	18	17	16	15	14	13	12	11	10	9	8	7	6	5	4	3	2	1	0
RESERVED	CALB_3V3_MODE1	RF_OUT_3V3	RESERVED	EXT_VCO_EN	RESERVED	VCO_AMP[2:0]	CALB_3V3_MODE0	RESERVED	VCALB_MODE	KVCO_COMP_DIS	PFD_POL	REF_BUFF_MODE[1:0]	MUTE_LOCK_EN	LD_ACTVLOW	LD_PREC[2:0]	LD_COUNT[2:0]										
RW	RW	RW	RW	RW	RW	RW	RW	RW	RW	RW	RW	RW	RW	RW	RW	RW	RW	RW	RW	RW	RW	RW	RW	RW	RW	RW

Address: STuW81300BaseAddress + 0x04

Type: R/W

Description: Lock det. control, Ref. Buffer, CP supply mode, VCO settings, Output power control

[26:25] RESERVED: must be set to '0'

[24] CALB_3V3_MODE1: calibrator supply mode bit1

0: when VCC_VCO_Core = 4.5 V

1: when VCC_VCO_Core = 3.3 V

This feature is not available on product codes STUW81300-1T and STUW81300-1TR. This bit must be set to '0' on these.

[23] RF_OUT_3V3: RF output power control bit

0: when VCC_RFOUT = 4.5 V

1: when VCC_RFOUT = 3.3 V

[22:20] RESERVED: must be set to '0'

[19] EXT_VCO_EN: external VCO Buffer enable

0: external VCO buffer disabled; integrated VCOs are used

1: external VCO buffer enabled; external VCO required (internal VCOs are powered down)

[18] RESERVED: must be set to '0'

[17:15] VCO_AMP: set VCO signal amplitude at the internal oscillator circuit nodes; higher signal level gives best phase noise performance while lower signal level gives low current consumption.

Different ranges of value are available, based upon the supply voltage provided to pin VCC_VCO_core (pin #3).

Allowed settings:

000 to 010: (0-2) when VCO core is supplied at 3.3 V

000 to 111: (0-7) when VCO core is supplied at 4.5 V

[14] CALB_3V3_MODE0: calibrator supply mode bit0

0: when VCC_VCO_Core = 4.5 V

1: when VCC_VCO_Core = 3.3 V

This feature is not available on product codes STUW81300-1T and STUW81300-1TR. This bit must be set to '0' on these.

[13] RESERVED: must be set to '0'

- [12] VCALB_MODE: VCO calibrator mode selection.
Settings for VCO core supplied at 4.5 V:
0: Mandatory for $F_{VCO} \leq 4500$ MHz
1: Mandatory for $F_{VCO} > 4500$ MHz
Settings for VCO core supplied at 3.3 V:
0: Not allowed
1: Mandatory for the whole F_{VCO} range
- [11] KVC0_COMP_DIS: disable K_{VCO} compensation circuit
0: compensation enabled (default - CP current auto-adjusted to compensate K_{VCO} variation)
1: compensation disabled (CP current fixed by CP_SEL settings)
- [10] PFD_POL: set PFD polarity
0: standard mode (default)
1: "inverted" mode (to be used only with active inverting loop filter or with VCO with negative tuning characteristics)
- [9:8] REF_BUFF_MODE: set reference clock buffer mode
00: (0) Reserved
01: (1) Differential Mode (reference clock signal on pin #20 and #21)
10: (2) XTAL Mode (Xtal oscillator enabled with crystal connected on pin #20 and #21)
11: (3) Single Ended Mode (Ref. clock signal on pin #21)
- [7] MUTE_LOCK_EN: enables mute function
0: "mute on unlock" function disabled
1: "mute on unlock" function enabled (RF output stages are put OFF when PLL is unlocked)
- [6] LD_ACTIVELOW: set low state as lock indicator
0: set lock indicator active high (LD=0 means PLL unlocked; LD=1 means PLL locked)
1: set lock indicator active low (LD=0 means PLL locked; LD=1 means PLL unlocked)
- [5:3] LD_PREC: set lock detector precision
000: (0) 2 ns (default for integer mode)
001: (1) 4 ns (default for fractional mode)
010: (2) 6 ns
011: (3) 8 ns
100: (4) 10 ns
101: (5) 12 ns
110: (6) 14 ns
111: (7) 16 ns
- [2:0] LD_COUNT: set lock detector counter for lock condition
000: (0) 4
001: (1) 8 (default for $F_{PFD} \sim 1$ MHz in integer mode)
010: (2) 16
011: (3) 64
100: (4) 256
101: (5) 1024 (default for $F_{PFD} \sim 50$ MHz in both fractional/integer mode)
110: (6) 2048
111: (7) 4096

ST5 Register

26	25	24	23	22	21	20	19	18	17	16	15	14	13	12	11	10	9	8	7	6	5	4	3	2	1	0	
RESERVED																							RF2_OUTBUF_LP	RESERVED	DEMUX_LP	RESERVED	REF_BUFF_LP
RW																							RW	RW	RW	RW	RW

Address: STuW81300BaseAddress + 0x05

Type: R/W

Description: Low power mode control bit

[26:5] RESERVED: must be set to '0'

[4] RF2_OUTBUF_LP: RF2 Output Buffer low power mode (0=full power; 1=low power)

[3] RESERVED: must be set to '0'

[2] DEMUX_LP: RF DEMUX low power mode (0=full power; 1=low power)

[1] RESERVED: must be set to '0'

[0] REF_BUFF_LP: reference buffer low power mode (0=full power; 1=low power)

ST6 Register

26	25	24	23	22	21	20	19	18	17	16	15	14	13	12	11	10	9	8	7	6	5	4	3	2	1	0
DITHERING	CP_UP_OFF	CP_DN_OFF	DSM_ORDER[1:0]	RESERVED	EN_AUTOCAL	VCO_SEL[1:0]	VCO_WORD[4:0]				CAL_TEMP_COMP	PRCHG_DEL[1:0]	CAL_ACC_EN	CAL_DIV[8:0]												
RW	RW	RW	RW	RW	RW	RW	RW				RW	RW	RW	RW												

Address: STuW81300BaseAddress + 0x06

Type: R/W

Description: VCO Calibrator, Manual VCO control, DSM settings

- [26] DITHERING: at '1' enables dithering of DSM output sequence
- [25] CP_UP_OFF: for test purposes only; must be set to '0'
- [24] CP_DN_OFF: for test purposes only; must be set to '0'
- [23:22] DSM_ORDER: set the order of delta-sigma modulator
 - 00: (0) 3rd order DSM (recommended)
 - 01: (1) 2nd order DSM
 - 10: (2) 1st order DSM
 - 11: (3) 4th order DSM
- [21] RESERVED: must be set to '0'
- [20] EN_AUTOCAL:
 - 1: enable the VCO calibration auto-restart feature

This feature is not available on product codes STUW81300-1T and STUW81300-1TR. This bit must be set to '0' on these
- [19:18] VCO_SEL: VCO selection bit. For test purposes only.
 - 00: (0) VCO_LOW
 - 01: (1) VCO_LOW_MID
 - 10: (2) VCO_MID_HIGH
 - 11: (3) VCO_HIGH
- [17:13] VCO_WORD: select specific VCO sub-band (range:0 to 31). For test purposes only.
- [12] CAL_TEMP_COMP: temperature compensation for VCO calibration procedure (to be used when PLL Lock condition is required on extreme thermal cycles)
 - 0: compensation disabled (to be used with switching-frequency applications)
 - 1: compensation enabled (to be used with fixed-frequency applications)

- [11:10] PRCHG_DEL: set the number of calibration slots for pre-charge of VCTRL node at the voltage reference value used during VCO calibration procedure
- 00: (0) 1 slot (default)
 - 01: (1) 2 slots
 - 10: (2) 3 slots
 - 11: (3) 4 slots
- [9] CAL_ACC_EN: at '1' increase calibrator accuracy by removing residual error taking 2 additional calibration slots (default = '0')
- [8:0] CAL_DIV: Set Calibrator clock divider ratio (range:1 to 511); '0' set the maximum ratio ('511')

ST7 Register

26	25	24	23	22	21	20	19	18	17	16	15	14	13	12	11	10	9	8	7	6	5	4	3	2	1	0
RESERVED	LD_SDO_tristate	LD_SDO_MODE	SPI_DATA_OUT_DISABLE	LD_SDO_SEL[1:0]	REGDIG_OCP_DIS	CYCLE_SLIP_EN	FSTLCK_EN	CP_SEL_FL[4:0]	FSTLCK_CNT[12:0]																	
RW	RW	RW	RW	RW	RW	RW	RW	RW	RW																	

Address: STuW81300BaseAddress + 0x07

Type: R/W

Description: Fast Lock control, LD_SDO settings

- [26] RESERVED: must be set to '0'
- [25] LD_SDO_tristate: at '1' put LD_SDO out pin in tri-state mode
- [24] LD_SDO_MODE: LD_SDO output interface mode selection
0: Open Drain mode (Level Range: 1.8 V to 3.6 V)
1: 2.5V CMOS output mode
- [23] SPI_DATA_OUT_DISABLE: disable auto-switch of LD_SDO pin during SPI read mode
0: LD_SDO pin automatically switched to SPI data out line during SPI read mode
1: LD_SDO pin fixed to Lock detector indication (SPI read operation not possible)
- [22:21] LD_SDO_SEL: LD_SDO multiplexer output selection bit
00: (0) Lock Detector (default)
01: (1) VCO Divider output (for test purposes only)
10: (2) Calibrator VCO Divider output (for test purposes only)
11: (3) Fast Lock clock output (for test purposes only)
- [20] REGDIG_OCP_DIS: for test purposes only ; must be set to '0' (at '1' disable the over-current protection of Digital LDO Voltage Regulator)
- [19] CYCLE_SLIP_EN: at '1' enables cycle-slip feature
- [18] FSTLCK_EN: at '1' enables fast lock mode using pin #6 (PD_RF2/FL_SW)
- [17:13] CP_SEL_FL: set the Charge Pump current during fast lock time slot (range:0 to 31)
- [12:0] FSTLCK_CNT: Fast-Lock counter value (allowed setting range: 2 to 8191); set duration of fast-lock time slot as number of F_{PFD} cycles

ST8 Register

26	25	24	23	22	21	20	19	18	17	16	15	14	13	12	11	10	9	8	7	6	5	4	3	2	1	0
PD_RF2_DISABLE	RESERVED	RESERVED	RESERVED	RESERVED	RESERVED	RESERVED	RESERVED	REG_OCP_DIS	REG_DIG_PD	REG_DIG_VOUT[1:0]	RESERVED	REG_REF_PD	REG_REF_VOUT[1:0]	RESERVED	REG_RF_PD	REG_RF_VOUT[1:0]	RESERVED	REG_VCO_PD	REG_VCO_VOUT[1:0]	RESERVED	REG_VCO_4V5_PD	REG_VCO_4V5_VOUT[1:0]				
RW	RW	RW	RW	RW	RW	RW	RW	RW	RW	RW	RW	RW	RW	RW	RW	RW	RW	RW	RW	RW	RW	RW	RW	RW	RW	RW

Address: STuW81300BaseAddress + 0x08

Type: R/W

Description: LDO Voltage Regulator settings

- [26] PD_RF2_DISABLE: at '1' disable the hardware power down function of the pin PD_RF2 (pin #6) thus allowing the pin PD_RF1 (pin #5) to control the power down status of both RF output stages
- [25] RESERVED: must be set to '0'
- [24] RESERVED: must be set to '0'
- [23] RESERVED: must be set to '0'
- [22] RESERVED: must be set to '0'
- [21] RESERVED: must be set to '0'
- [20] RESERVED: must be set to '0'
- [19] REG_OCP_DIS: for test purposes only; must be set to '0' (at '1' disable the over-current protection of LDO voltage regulators except DIG regulator)
- [18] REG_DIG_PD: DIGITAL Regulator power down for test purposes only. Must be set to '0'
- [17:16] REG_DIG_VOUT: DIGITAL regulator output voltage set
 - 00: (0) 2.6 V (Default)
 - 01: (1) 2.3 V (for test purposes only)
 - 10: (2) 2.4 V (for test purposes only)
 - 11: (3) 2.5 V (for test purposes only)
- [15] RESERVED: must be set to '0'
- [14] REG_REF_PD: REFERENCE CLOCK Regulator power down for test purposes only. Must be set to '0'
- [13:12] REG_REF_VOUT: REFERENCE CLOCK Regulator output voltage set
 - 00: (0) 2.6 V (default)
 - 01: (1) 2.5 V (for test purposes only)
 - 10: (2) 2.7 V (for test purposes only)
 - 11: (3) 2.8 V (for test purposes only)
- [11] RESERVED: must be set to '0'
- [10] REG_RF_PD: RF Output section Regulator power down for test purposes only. Must be set to '0'

- [9:8] REG_RF_VOUT: RF output section regulator output voltage set
 - 00: (0) 2.6 V (default)
 - 01: (1) 2.5 V (for test purposes only)
 - 10: (2) 2.7 V (for test purposes only)
 - 11: (3) 2.8 V (for test purposes only)
- [7] RESERVED: must be set to '0'
- [6] REG_VCO_PD: VCO bias-and-control regulator power down for test purposes only. Must be set to '0'
- [5:4] REG_VCO_VOUT: VCO bias-and-control regulator output voltage set
 - 00: (0) 2.6 V (default)
 - 01: (1) 2.5 V (for test purposes only)
 - 10: (2) 2.7 V (for test purposes only)
 - 11: (3) 2.8 V (for test purposes only)
- [3] RESERVED: must be set to '0'
- [2] REG_VCO_4V5_PD: High-voltage regulator power down (to be used to supply VCO core, RF output final stage and Charge Pump) for test purposes only. Must be set to '0'
- [1:0] REG_VCO_4V5_VOUT: High-voltage regulator output voltage set (to be used to supply VCO core, RF output final stage and charge-pump output)
 - 00: (0) 5.0 V (Requires 5.4 V unregulated voltage line on pin# 36, for test purposes only)
 - 01: (1) 2.6 V (3.0 - 5.4 V unregulated voltage line range allowed on pin#36, for test purposes only)
 - 10: (2) 3.3 V (3.6 - 5.4 V unregulated voltage line range allowed on pin#36)
 - 11: (3) 4.5 V (5.0 - 5.4 V unregulated voltage line range allowed on pin#36)

ST9 Register

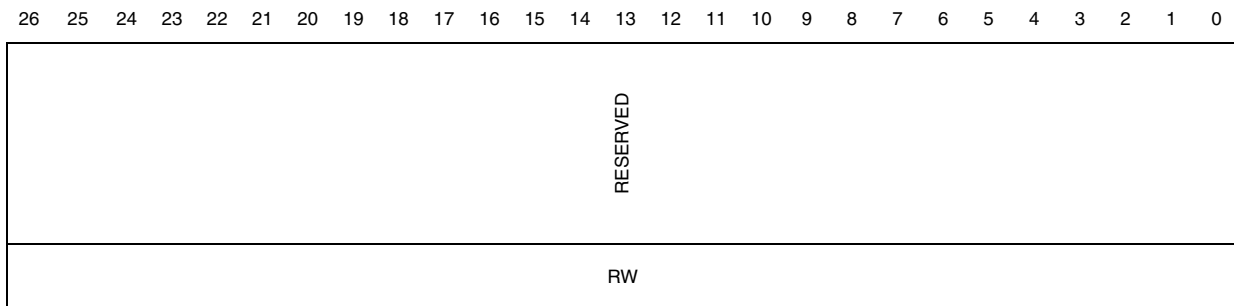

Address: STuW81300BaseAddress + 0x09
Type: R/W
Description: Reserved (Test & Initialization bit)

[26:0] RESERVED: Test and Initialization bit; must be set to '0'

ST10 Register

26	25	24	23	22	21	20	19	18	17	16	15	14	13	12	11	10	9	8	7	6	5	4	3	2	1	0
RESERVED								REG_DIG_STARTUP	REG_REF_STARTUP	REG_RF_STARTUP	REG_VCO_STARTUP	REG_VCO_4V5_STARTUP	REG_DIG_OCP	REG_REF_OCP	REG_RF_OCP	REG_VCO_OCP	REG_VCO_4V5_OCP	LOCK_DET	VCO_SEL[1:0]	WORD[4:0]						
R								R	R	R	R	R	R	R	R	R	R	R	R	R	R					

Address: STuW81300BaseAddress + 0x0A

Type: R

Description: VCO, Lock det. Status, LDO status

[26:18] RESERVED: fixed to '0'

[17] REG_DIG_STARTUP: DIGITAL regulator ramp-up indicator ('1' means correct start-up)

[16] REG_REF_STARTUP: REFERENCE CLOCK regulator ramp-up indicator ('1' means correct start-up)

[15] REG_RF_STARTUP: RF Output section regulator ramp-up indicator ('1' means correct start-up)

[14] REG_VCO_STARTUP: VCO bias-and-control regulator ramp-up indicator ('1' means correct start-up)

[13] REG_VCO_4V5_STARTUP: High-voltage regulator ramp-up indicator ('1' means correct start-up)

[12] REG_DIG_OCP: DIGITAL regulator over-current protection indicator ('1' means over-current detected)

[11] REG_REF_OCP: REFERENCE CLOCK regulator over-current protection indicator ('1' means over-current detected)

[10] REG_RF_OCP: RF Output section regulator over-current protection indicator ('1' means over-current detected)

[9] REG_VCO_OCP: VCO bias and control regulator over-current protection indicator ('1' means over-current detected)

[8] REG_VCO_4V5_OCP: high-voltage regulator over-current protection indicator ('1' means over-current detected)

[7] LOCK_DET: Lock detector status bit ('1' means PLL locked)

[6:5] VCO_SEL: VCO selected by calibration algorithm

00: (0) VCO_LOW

01: (1) VCO_LOW_MID

10: (2) VCO_MID_HIGH

11: (3) VCO_HIGH

[4:0] WORD: specific VCO sub-band selected by calibration algorithm (range:0 to 31)

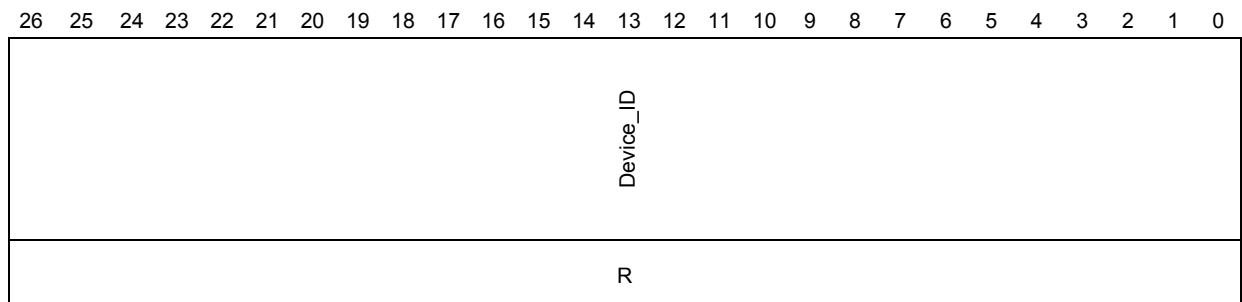
ST11 Register

Address: STuW81300BaseAddress + 0x0B

Type: R

Description: Device identifier

[26:0] Device_ID:

0x000804B for product codes STUW81300-1T and STUW81300-1TR

0x0008052 for product codes STUW81300T and STUW81300TR

7.17 Power-on sequence

In order to guarantee the correct start-up of the internal circuitry after the power on, the following steps must be followed:

1. Power up the device (LDO supply pins: pin#9 #18, #28 and #36)
2. Once the voltages applied on the LDO supply pins are stable, wait 50 ms. (After this transient time, the LDOs are powered on with the regulated voltages available at pins #2, #8, #19, #27 and #29, while all other circuits are in power down mode).
3. Provide the reference clock signal.
4. Implement the first programming sequence as follows:
 - a) program register ST9 (test and initialization) with all bits set to '0'.
 - b) program register ST0 according to the desired configuration
 - c) program the following registers in the specified order according to the desired configuration: ST8, ST7, ST6, ST5, ST4, ST3, ST2, ST1, ST0.
5. Check the PLL Lock status on pin LD_SDO (pin #26) and/or read all relevant information provided on registers ST10 and ST11.

7.18 Example register programming

Setup conditions and requirements

- Unregulated Supply voltage: 5.0 V
- Reference Clock: 100 MHz , single-ended, sine wave
- LO Frequency: 15220 MHz – exact freq. mode (VCO Frequency=7610 MHz)
- Phase Noise requirements: full performance VCO; full performance Noise floor

Register configurations (Hex values including register address)

- ST9 = 0x48000000 (initialization; all bits set to '0')
- ST8 = 0x40000003 (REG_4V5 = 4.5 V)
- ST7 = 0x39000000 ("fast lock" not used; LD_SDO pin configured as 2.5 V CMOS buffer)
- ST6 = 0x30001000 (DITHERING=0; DSM_ORDER=0 for 3rd order DSM; CAL_TEMP_COMP = 1 to keep lock over temperature drift; CALDIV = 0)
- ST5 = 0x28000000 (low power modes not used)
- ST4 = 0x20039315 (lock detector setting for fractional mode and F_{PFD} = 50 MHz; REF_BUF_MODE=3 for single-ended mode; VCO_AMP = 7 for best VCO phase noise @4.5 V supply; VCALB_MODE=1 for VCO frequency>4500 MHz)
- ST3 = 0x18008002 (PFD_DEL_MODE = "VCO_DIV_delayed"; R=2 and REF_PATH_SEL=0 "direct" for F_{PFD} = 50 MHz)
- ST2 = 0x1000000A (MOD=10; RF2_OUT_PD = 0 for RF2 output with VCO doubled frequency)
- ST1 = 0x09400001 (FRAC = 1 RF2_OUT_PD = 1 set RF1 output in power down; PLL_SEL = 1 to enable VCO divider by 2 path to PLL as VCO freq > 6 GHz)
- ST0 = 0x03E0004C (N_{INT} = 76; PFD_DEL = 1.2 ns; CPSEL = 31 for I_{CP} = 4.9 mA)

8 Application information

8.1 Application diagram

Figure 26. Application diagram

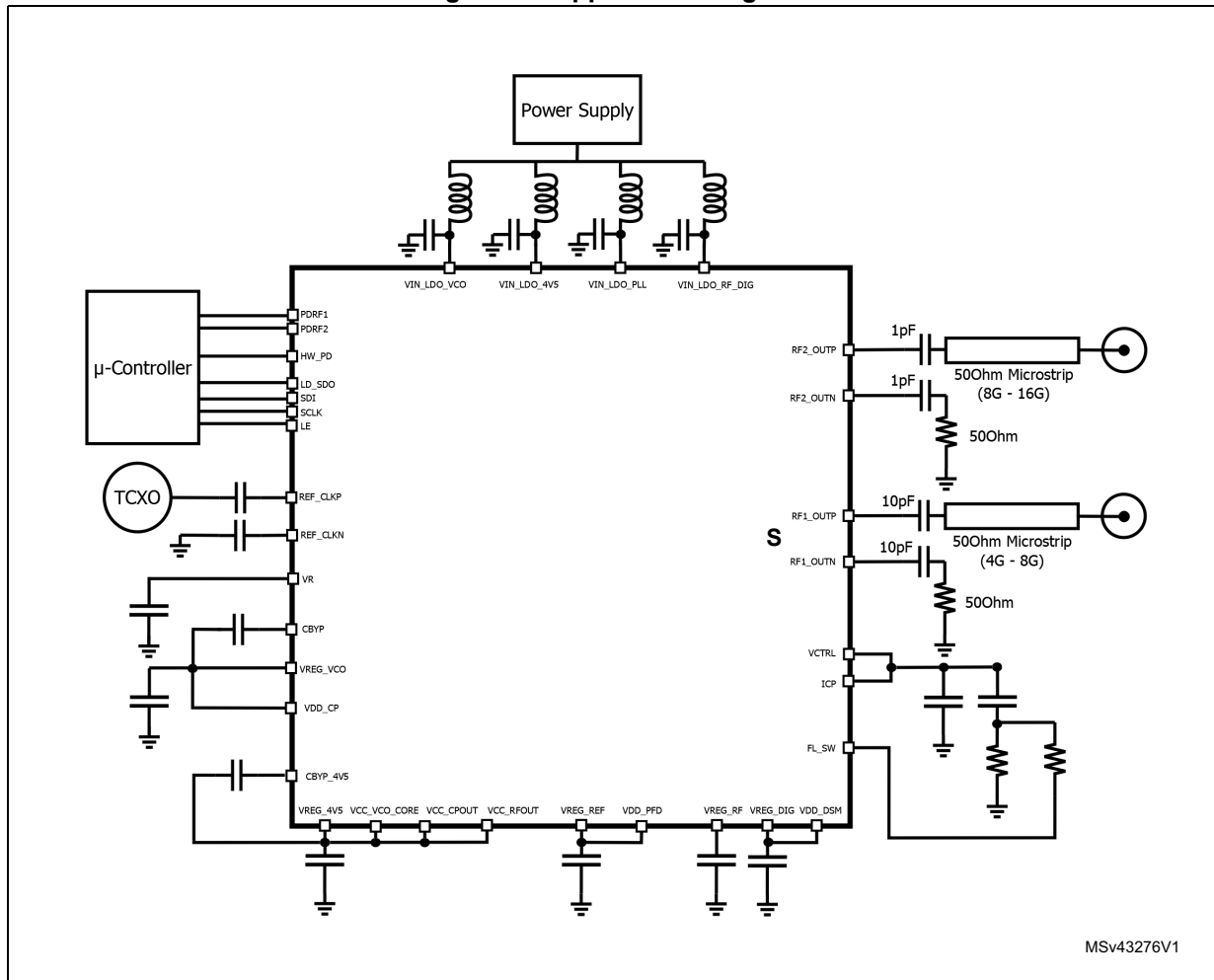

Note: Visit the STuW81300 product page on the ST website (www.st.com) to download the evaluation board data brief including PCB schematics.

8.2 Thermal PCB design considerations

The STuW81300 QFN package offers a low thermal resistance ($\theta_{JC} \sim 3 \text{ }^\circ\text{C/W}$ on a JEDEC Multi-Layer Board). Preferred thermal flow in QFN package is through the bottom central pad.

The central thermal pad provides a solderable surface on the top of the PCB (for soldering the package die paddle on the board). Thermal vias are needed to provide a thermal path to the inner and bottom layers of the PCB in order to remove/dissipate the heat. The size of the thermal pad can be matched with the exposed die paddle, or it may be smaller taking into consideration clearance for vias to route the inner row signals.

A PCB can be designed to achieve a thermal impedance of 2 to 4 $^\circ\text{C/W}$ through a 1.6 mm (.063") thick FR-4 type PCB (a reliable, low cost solution).

For example the ST EVAL KIT uses a 0.8 mm thick PCB with a thermal impedance of $\sim 50 \text{ }^\circ\text{C/W}$ for a single via filled with solder. 25 vias are used, giving a thermal impedance of $\sim 2 \text{ }^\circ\text{C/W}$ with solder-filled vias ($50 \text{ }^\circ\text{C/W}$ divided by 25 vias).

Using a plate on the underside of the PCB (a common solution in STuW81300 applications, as the plate is typically the metal housing of the application assembly) brings the total thermal resistance (junction to housing in the customer application) below $10 \text{ }^\circ\text{C/W}$.

As the typical power dissipation of the STuW81300 is approximately 1.5 W, at maximum specified ambient temperature ($85 \text{ }^\circ\text{C}$) a junction temperature of $\sim 100 \text{ }^\circ\text{C}$ is attainable. This is well below the maximum specified value ($125 \text{ }^\circ\text{C}$) to ensure safe operation of the STuW81300 in worst-temperature conditions.

The ST EVAL KIT is not provided with additional heatsinking, and the thermal resistance (θ_{JA}) measured in the EVAL BOARD is $\sim 30 \text{ }^\circ\text{C/W}$.

8.3 Robust VCO calibration over full temperature range

Some applications require synthesis of a fixed frequency while keeping the lock condition, without any phase/frequency jumps, even if temperature drift occurs over the whole operating temperature range.

In such cases, the capability of the STuW81300 to stay locked - with the specific VCO and sub-bands selected by the VCO auto-calibration procedure - is defined by the ΔT_{LOCK} parameter (see [Table 6: Electrical specifications](#)).

If the application requires a larger temperature drift, a factory VCO calibration at fixed/controlled temperature may be applied.

The concept is to run the standard VCO auto-calibration procedure (after writing the [STO Register](#)) in the factory at $25 \text{ }^\circ\text{C}$. The resulting frequency, VCO and sub-band information is then stored in non-volatile memory. In the field, the STuW81300 is set up using a manual VCO calibration, recalling the VCO and sub-band data previously stored in the application memory.

In this way, with a good thermal PCB design to limit the maximum junction temperature to $100 \text{ }^\circ\text{C}$ (see [Section 8.2: Thermal PCB design considerations](#)), the STuW81300 VCO is calibrated virtually at $25 \text{ }^\circ\text{C}$, regardless of the effective temperature during in-field setup. This guarantees the lock condition for any temperature drift within the operating temperature range.

In order to execute the robust VCO calibration in-factory at a controlled temperature (25 °C), a software routine must be implemented that is able to:

- Program the device over the desired VCO frequency range (5 MHz frequency step or lower, regardless of the application frequency step)
- Read the lock detector indication (from the LD_SDO pin or from the [ST10 Register](#))
- Read the VCO_SEL (2 bits) and WORD (5 bits) from the [ST10 Register](#)
- Store the data (VCO frequency, VCO_SEL and WORD) in the non-volatile memory of the application.

The procedure is detailed below, using an example where the application requires synthesis of a carrier frequency over a wide range; from 11.8 GHz to 12.2 GHz. Hence the VCO should be pre-calibrated in-factory over the frequency range 5.9 GHz to 6.1 GHz.

1. Execute the power-up procedure (see [Section 7.17: Power-on sequence](#)) configuring the device registers (see [Section 7.18: Example register programming](#)) with suitable settings for the first VCO frequency (5.9 GHz):
 - a) Wait for the lock time, read the lock detector, read VCO_SEL and WORD from the [ST10 Register](#)
 - b) Store frequency data (5.9 GHz), VCO_SEL and WORD values in memory.
2. Configure the device for the next VCO frequency (5.905 GHz):
 - a) Wait for the lock time, read the lock detector, read VCO_SEL and WORD values from the [ST10 Register](#).
 - b) Store frequency data, VCO_SEL and WORD values in memory **only** if the current values of the pair VCO_SEL/WORD are different from the previous step.
3. Configure the device for next VCO frequency (5.91 GHz):
 - a) Repeat step 2 a)
 - b) Repeat step 2 b)

Next steps. Repeat step 3 for all intermediate frequencies (5.915, 5.92,.. 6.095 GHz).

Final step. Configure the device for the last VCO frequency (6.1 GHz):

- a) Wait for the lock time, read the lock detector, read VCO_SEL and WORD values from the [ST10 Register](#).
- b) Store frequency data, VCO_SEL and WORD values in memory **only** if the current values of the pair VCO_SEL/WORD are different from the previous step.

Note: The number of records to be stored in memory is less than the number of steps performed, requiring only a small amount of memory. In our example we have swept 41 VCO frequency steps but only 7 records need to be saved (the number of records to be stored depends on the VCO sub-band spacing).

Table 11. Example of data for robust VCO calibration routine to be stored in the application memory

VCO frequency (MHz)	VCO_SEL	WORD	Notes
5900	1	1	Range (5900 to 5914.999 MHz) uses VCO=1, WORD=1
5915	1	0	Range (5915 to 5964.999 MHz) uses VCO=1, WORD=0
5965	2	26	Range (5965 to 5979.999 MHz) uses VCO=2, WORD=26
5980	2	25	Range (5980 to 6009.999 MHz) uses VCO=2, WORD=25
6010	2	24	Range (6010 to 6044.999 MHz) uses VCO=2, WORD=24
6045	2	23	Range (6045 to 6079.999 MHz) uses VCO=2, WORD=23
6080	2	22	Range (6080 to 6100 MHz) uses VCO=2, WORD=22

The operations to be performed in-field in order to configure the device at VCO frequency = 6.0 GHz are:

1. Execute the power-up procedure, configuring the device registers with suitable settings for the desired VCO frequency (6.0 GHz), with VCO auto-calibration disabled (see step 2 below)
2. Write registers as indicated in [Section 7.18: Example register programming](#), setting the MAN_CALB_EN bit ([ST1 Register](#)) to '1'. Use the pair VCO_SEL/WORD stored in the memory (2/25 from record number 4 for 6.0 GHz) to set the VCO_SEL and VCO_WORD bits ([ST6 Register](#)).

The count of the records and the values of stored VCO_SEL/WORD pairs changes slightly when applying the same routine over different samples, so this calibration procedure is needed for each part.

Table 12. VFQFPN - 36 pin, 6x6 mm, 0.5 mm pitch very thin profile fine pitch quad flat package mechanical data

Symbol	millimeters			inches ⁽¹⁾		
	Min	Typ	Max	Min	Typ	Max
A	0.800	0.900	1.000	0.0315	0.0354	0.0394
A1	-	0.020	0.050	-	0.0008	0.0020
A2	-	0.650	1.000	-	0.0256	0.0394
A3	-	0.200	-	-	0.0079	-
b	0.180	0.230	0.300	0.0071	0.0091	0.0118
D	5.875	6.000	6.125	0.2313	0.2362	0.2411
D2	4.00	4.10	4.20	0.1575	0.1614	0.1654
E	5.875	6.000	6.125	0.2313	0.2362	0.2411
E2	4.00	4.10	4.20	0.1575	0.1614	0.1654
e	0.450	0.500	0.550	0.0177	0.0197	0.0217
L	0.350	0.550	0.750	0.0138	0.0217	0.0295
K	0.250	-	-	0.0098	-	-
ddd	-	-	0.080	-	-	0.0031

1. Values in inches are converted from mm and rounded to 4 decimal digits.

Figure 28. VFQFPN - 36 pin, 6x6 mm, 0.5 mm pitch very thin profile fine pitch quad flat package recommended footprint

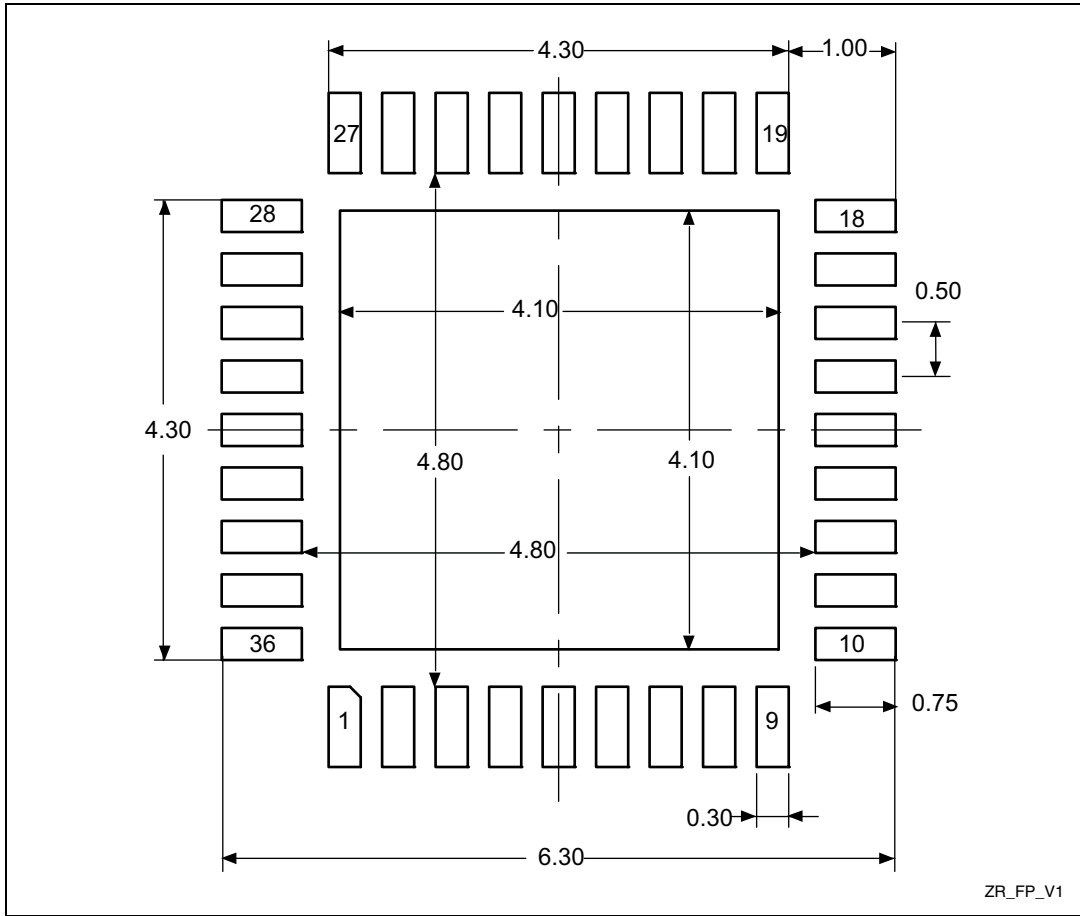

1. Dimensions are expressed in millimeters.

10 Evaluation kit

An evaluation kit can be delivered upon request (see [Table 13](#) for order codes), including the following items:

- Evaluation board
- GUI (graphical user interface) to configure the board and the STuW81300 IC
- STWPLLSim software for PLL loop filter design and phase noise/transient simulation
- A comprehensive set of documentation (evaluation-board data brief including PCB schematics, GUI help and STWPLLSim user manual).

The evaluation kit and related software and documentation can be ordered/downloaded at www.st.com.

Table 13. STuW81300 evaluation-kit order codes

Order Code	Description
STuW81300-EVB	STuW81300 Evaluation Kit (evaluation board, GUI and STWPLLSim tool)
STSW-RFSOL001	STWPLLSim simulation tool for STuW81300
STSW-RFSOL003	GUI for configuring STuW81300 evaluation board

11 Revision history

Table 14. Document revision history

Date	Revision	Changes
14-Oct-2015	1	Initial release.
16-Oct-2015	2	Corrected K_{VCO} figures in Table 6: Electrical specifications Corrected entries in Table 7: Phase noise specifications for: <ul style="list-style-type: none"> – VCO direct - Open Loop @ 8000 MHz (figures only) – VCO and frequency doubler- Open Loop @ 7700 MHz (title and figures) – VCO and frequency doubler- Open Loop @ 12 GHz (title and figures) – VCO and frequency doubler- Open Loop @ 16 GHz (title and figures) Corrected VCO_SEL bitfield descriptions settings in ST6 Register and ST10 Register .
12-Jan-2016	3	Cover page: <ul style="list-style-type: none"> – changed cover page title (added 'microwave') – updated Table 1: Device summary. Updated: <ul style="list-style-type: none"> – K_{VCO} figures in Table 6: Electrical specifications – Table 7.7: Charge pump – Table 7.17: Power-on sequence. In ST6 Register description, following fields marked 'for test purposes only': <ul style="list-style-type: none"> – VCO_SEL – VCO_WORD Added Section 10: Evaluation kit . In Table 13: VFQFPN36 package mechanical data updated dimensions D2 and E2.

Table 14. Document revision history

Date	Revision	Changes
12-Aug-2016	4	<p>Explicitly defined supply connections in: Table 2: Pin descriptions.</p> <p>Updated V_{CC} parameter in:</p> <ul style="list-style-type: none"> – Table 3: Absolute maximum ratings – Table 4: Operating conditions. <p>Removed block-specific power supply parameters and T_{LK} definition from Table 6: Electrical specifications.</p> <p>Aligned supply range to 4.5 V max. in:</p> <ul style="list-style-type: none"> – Table 7: Phase noise specifications – Section 7.7: Charge pump (also removed register dependence) – Section 7.10: Voltage controlled oscillators (VCOs). <p>Updated: Section 7.13: LDO voltage regulators</p> <p>In ST0 Register updated type and description of bit 26.</p> <p>In ST3 Register corrected width of bitfield R[12:0].</p> <p>In ST4 Register updated:</p> <ul style="list-style-type: none"> – width and description of bitfield VCO_AMP[2:0]) – description of bitfield CP_SUPPLY_MODE. <p>In ST8 Register updated descriptions of bitfields:</p> <ul style="list-style-type: none"> – REG_DIG_PD – REG_REF_PD – REG_RF_PD. <p>Updated Section 7.18: Example register programming.</p> <p>Updated Table 13: VFQFPN36 package mechanical data.</p>

Table 14. Document revision history

Date	Revision	Changes
16-Dec-2016	5	<p>Changed document settings to 'production data'.</p> <p>Updated Table 1: Device summary.</p> <p>Added ΔT_{LOCK} parameters in Table 6: Electrical specifications, including:</p> <ul style="list-style-type: none"> – VCC_VCO_Core = 3.3 V ΔT_{LOCK} operation (product code exclusions mentioned in table footnote) – ΔT_{LOCK} operation at VCC_VCO_Core = 4.5 V indicated. <p>In Table 7: Phase noise specifications specified:</p> <ul style="list-style-type: none"> – VCO direct – open loop @ 6 GHz, VCC_VCO_Core = 3.3 V – VCO and frequency doubler – open loop @ 12 GHz, VCC_VCO_Core = 3.3 V – Added VCC_VCO_Core conditions for all other parameters. <p>Updated Section 7.1: Reference input stage.</p> <p>Updated Section 7.10: Voltage controlled oscillators (VCOs)</p> <p>Added VCO calibration auto-restart feature on page 30.</p> <p>In ST4 Register:</p> <ul style="list-style-type: none"> – Replaced bitfield CP_SUPPLY_MODE with VCALB_MODE – Added bitfields CALB_3V3_MODE0 and CALB_3V3_MODE1. <p>Removed bitfield DOUBLER_LP in ST5 Register.</p> <p>Added bitfield EN_AUTOCAL in ST6 Register.</p> <p>Updated device identifier in ST11 Register.</p> <p>Updated Register configurations (Hex values including register address) on page 51.</p> <p>Added new Section 8.3: Robust VCO calibration over full temperature range.</p>
09-Aug-2019	6	<p>Updated:</p> <ul style="list-style-type: none"> – applications list on cover page – Figure 1: STuW81300 functional block diagram (corrected LDO VCO and LDO 4V5 block names) – Section 7.10: Voltage controlled oscillators (VCOs) – footnote of Figure 26: Application diagram <p>Updated descriptions of the following registers:</p> <ul style="list-style-type: none"> – ST0 Register – ST2 Register – ST3 Register – ST6 Register – ST7 Register <p>Updated Section 9: Package information.</p>