

## SVxx50xAx Series 50 A High Junction Temperature SCRs

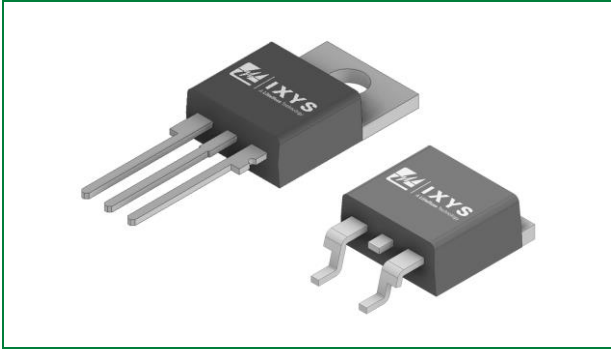

### Agency Approvals and Environmental

Environmental Approvals



### Product Summary

Characteristic	Value	Unit
$I_{T(RMS)}$	50	A
$V_{DRM} / V_{RRM}$	600	V
$I_{GT}$	15	mA

### Schematic Symbol

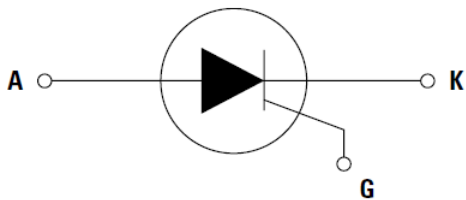

### Product Description

This SV6050xAx high temperature SCR series is ideal for unidirectional switch applications such as phase controls, motor speed controls, Solid State Relays, and inrush current controllers.

Standard phase control SCRs are triggered with few milliamperes of current at less than 1.5 V potential.

### Features

- Halogen-free and RoHS compliant
- 150 °C maximum junction temperature
- High dv/dt performance up to 1000 V/μs
- Surge capability up to 550 A at 60 Hz half cycle
- AEC-Q101 qualified

### Applications

- Typical applications are AC solid-state switches, phase controller, rectifier and voltage regulator, inrush current limit circuit.

- 1. Maximum Ratings.....3
- 2. Thermal Characteristics .....3
- 3. Electrical Characteristics.....3
- 4. Static Characteristics .....3
- 5. Performance Curves .....4
- 6. Soldering Parameters .....6
- 7. Physical Specifications.....6
- 8. Environmental Specifications.....6
- 9. Design Considerations.....6
- 10. Package Dimensions .....7
- 11. Part Numbering and Marking.....8
- 12. Product Selector .....8
- 13. Packing Options.....8
- 14. Packing Specifications .....9

## 1. Maximum Ratings

Symbol	Characteristic	Conditions		Value	Unit
$V_{DSM}/V_{RSM}$	Peak Non-repetitive Blocking Voltage	Pulse Width = 100 $\mu$ s		700	V
$I_{T(RMS)}$	RMS On-state Current	SVxx50RAx/ SVxx50NAx	$T_C = 110\text{ }^\circ\text{C}$	50	A
$I_{T(AV)}$	Average On-state Current	SVxx50RAx/ SVxx50NAx	$T_C = 110\text{ }^\circ\text{C}$	31.5	A
$I_{TSM}$	Non-repetitive Surge Peak On-state Current (Single Half Cycle, $T_J$ Initial = 25 $^\circ\text{C}$ )	f = 50 Hz, t = 20 ms		456	A
		f = 60 Hz, t = 16.7 ms		550	
$I^2t$	$I^2t$ Value for Fusing	$t_p = 8.3$ ms		1255	A <sup>2</sup> s
di/dt	Critical Rate of Rise of On-state Current	f = 60 Hz, $T_J = 150\text{ }^\circ\text{C}$		100	A/ $\mu$ s
$I_{GTM}$	Peak Gate Trigger Current	$t_p = 20\text{ }\mu\text{s}$ , $T_J = 150\text{ }^\circ\text{C}$		4	A
$P_{G(AV)}$	Average Gate Power Dissipation	$T_J = 150\text{ }^\circ\text{C}$		1	W
$T_{STG}$	Storage Temperature	-		-40 to 150	$^\circ\text{C}$
$T_J$	Operating Junction Temperature	-		-40 to 150	$^\circ\text{C}$

## 2. Thermal Characteristics

Symbol	Characteristic		Value	Unit
$R_{th(JC)}$	Thermal Resistance, junction-to-case (AC)	SVxx50RAx/ SVxx50NAx	0.7	$^\circ\text{C}/\text{W}$

## 3. Electrical Characteristics

Symbol	Description	Conditions	Value			Unit	
			Min	Typ	Max		
$I_{GT}$	DC Gate Trigger Current	$V_D = 12\text{ V}$ , $R_L = 60\text{ }\Omega$	6	-	15	mA	
$V_{GT}$	DC Gate Trigger Voltage	$V_D = 12\text{ V}$ , $R_L = 60\text{ }\Omega$	-	-	1.3	V	
$I_H$	Holding Current	$I_T = 400\text{ mA}$ (initial)	-	-	50	mA	
$V_{GD}$	Gate Non-trigger Voltage	$V_D = V_{DRM}$ , $R_L = 3.3\text{ k}\Omega$ , $T_J = 150\text{ }^\circ\text{C}$	0.2	-	-	V	
dv/dt	Critical Rate-of-rise of Off-stage Voltage	Gate Open, $T_J = 150\text{ }^\circ\text{C}$	$V_D = 2/3 V_{DRM}$	1000	-	-	V/ $\mu$ s
			$V_D = V_{DRM}$	500	-	-	
$t_q$	Turn-off Time	$I_T = 2\text{ A}$ ; $t_p = 50\text{ }\mu\text{s}$ ; $dv/dt = 5\text{ V}/\mu\text{s}$ ; $di/dt = 30\text{ A}/\mu\text{s}$	-	-	25	$\mu\text{s}$	
$t_{gt}$	Turn-on Time	$I_G = 2 \times I_{GT}$ , $P_W = 15\text{ }\mu\text{s}$ , $I_T = 100\text{ A}$	-	2	-	$\mu\text{s}$	

## 4. Static Characteristics

Symbol	Description	Conditions	Maximum Value	Unit
$V_{TM}$	Peak On-state Voltage	$I_{TM} = 100\text{ A}$ , $t_p = 380\text{ }\mu\text{s}$	1.6	V
$V_{T0}$	Threshold Voltage	$T_J = 150\text{ }^\circ\text{C}$	0.8	V
$R_D$	Dynamic Resistance	$T_J = 150\text{ }^\circ\text{C}$	9	m $\Omega$
$I_{DRM}/I_{RRM}$	Off-state Current, Peak Repetitive	$T_J = 25\text{ }^\circ\text{C}$	5	$\mu\text{A}$
		$T_J = 150\text{ }^\circ\text{C}$	5	mA

### 5. Performance Curves

Figure 1. Normalized DC Gate Trigger Current vs. Junction Temperature

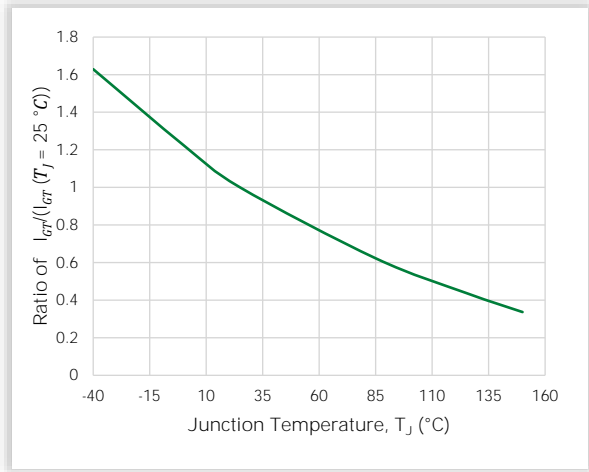

Figure 2. Normalized DC Gate Trigger Voltage vs. Junction Temperature

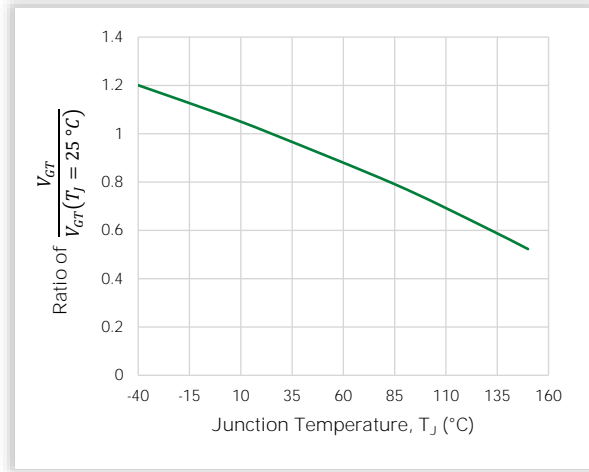

Figure 3. Normalized DC Holding Current vs. Junction Temperature

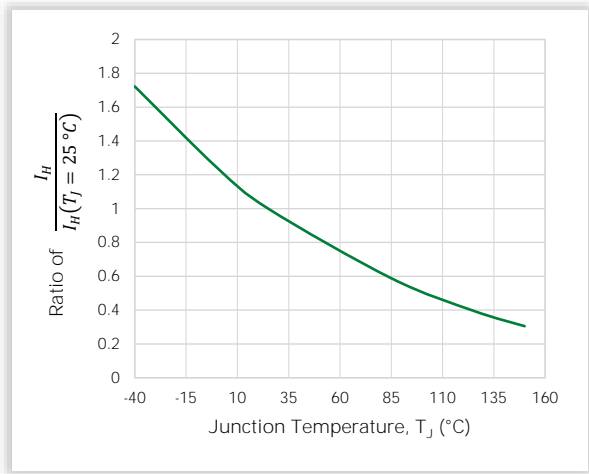

Figure 4. Typical On-state Current vs. On-state Voltage

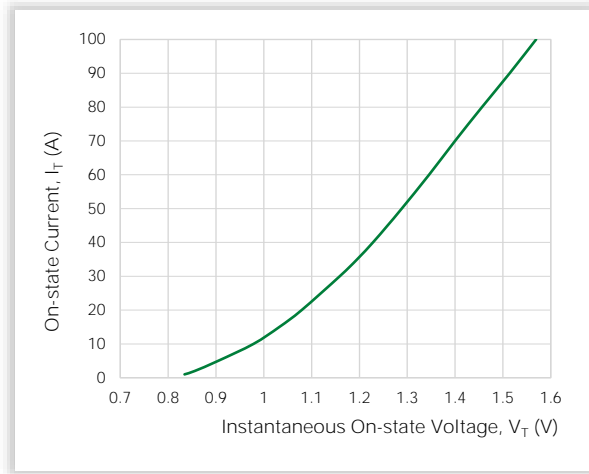

Figure 5. Typical Power Dissipation vs. RMS On-state Current

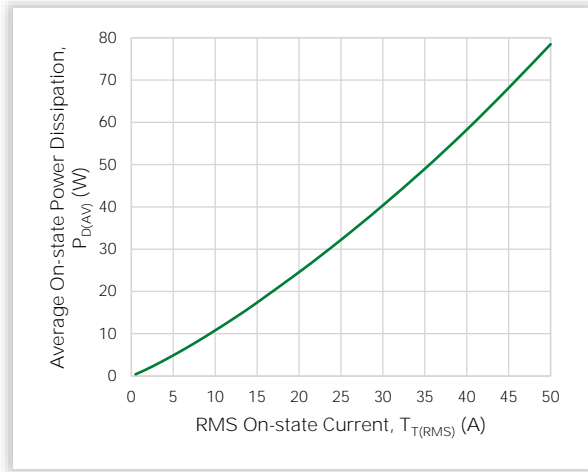

Figure 6. Maximum Allowable Case Temperature vs. RMS On-state Current

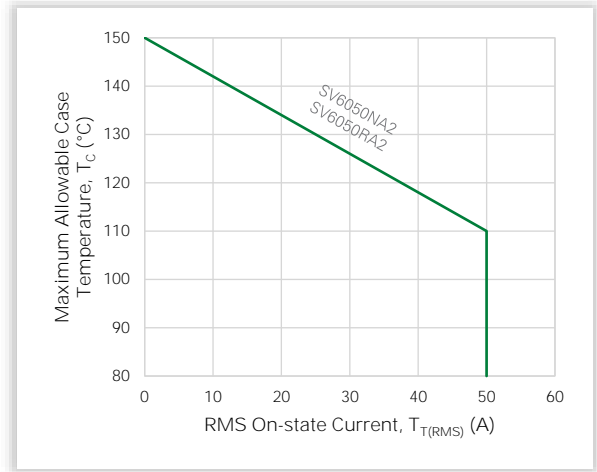

Figure 7. Maximum Allowable Case Temperature vs. Average On-state Current

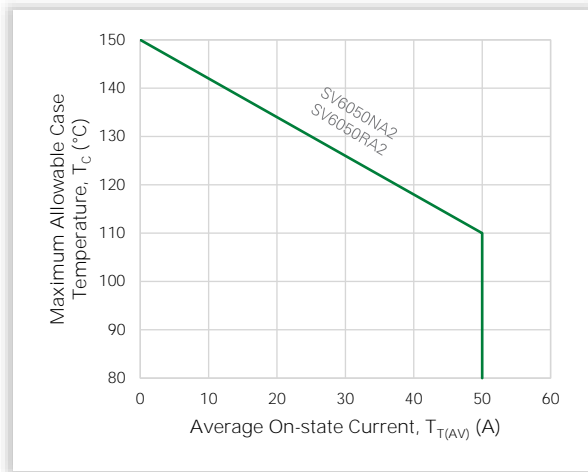
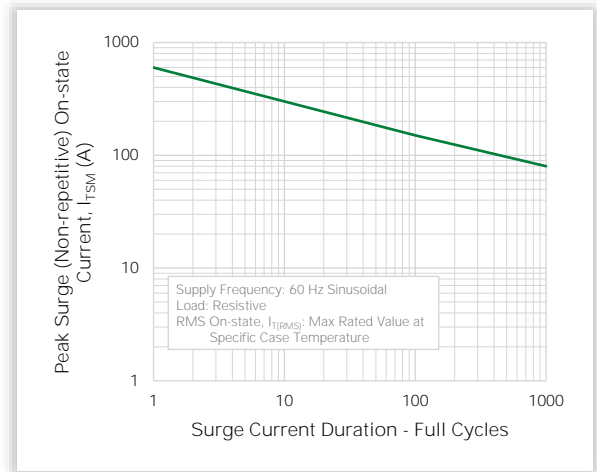

Figure 8. Surge Peak On-state Current vs. Number of Cycles



Notes:

1. Gate control may be lost during and immediately following surge current interval.
2. Overload may not be repeated until junction temperature has returned to steady-state rated value.

### 6. Soldering Parameters

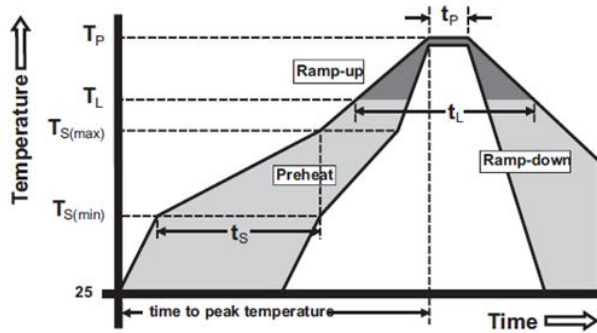

Parameter	Value	
Reflow Condition	Pb-free Assembly	
Pre-Heat	Temperature Min, $T_{S(\text{Min})}$	150 °C
	Temperature Max, $T_{S(\text{Max})}$	200 °C
	Time (Min to Max), $t_s$	60 to 180 s
Average Ramp-up Rate Liquidus Temp., $T_L$ to peak	5 °C/s (Max)	
$T_{S(\text{Max})}$ to $T_L$ Ramp-up Rate	5 °C/s (Max)	
Reflow	Temperature, $T_L$ Liquidus	217 °C
	Time, $t_L$	60 to 150 s
Peak Temperature, $T_P$	260 °C ( $\pm 5$ °C)	
Time within 5 °C of Actual Peak Temperature, $t_p$	20 to 40 s	
Ramp-down Rate	5 °C/s (Max)	
Time 25 °C to Peak Temperature, $T_P$	8 minutes (Max)	
Do Not Exceed	280 °C	

### 7. Physical Specifications

Device Feature	Detail
Terminal Finish	100% Matte Tin-plated
Body Material	UL Recognized Compound meeting Flammability Rating V-0
Terminal Material	Copper Alloy

### 9. Design Considerations

Careful selection of the correct component for the application's operating parameters and environment will go a long way toward extending the operating life of the Thyristor. Good design practice should limit the maximum continuous current through the main terminals to 75% of the component rating. Other ways to ensure long life for a power discrete semiconductor are proper heat sinking and selection of voltage ratings for worst case conditions. Overheating, overvoltage (including dv/dt), and surge currents are the main killers of semiconductors. Correct mounting, soldering, and forming of the leads also help protect against component damage.

### 8. Environmental Specifications

Test	Specifications and Conditions
AC Blocking	MIL-STD-750, M-1040, Cond A Applied Peak AC voltage @ 150°C for 1008 hours
Temperature Cycling	MIL-STD-750, M-1051, 1000 cycles; -55°C to +150°C; 15 min dwell time
Temperature/Humidity	EIA / JEDEC, JESD22-A101 1008 hours; 160V - DC: 85°C; 85% relative humidity
Resistance to Solder Heat	MIL-STD-750 Method 2031
Solderability	ANSI/J-STD-002, category 3, Test A
Lead Bend	MIL-STD-750, M-2036 Cond E
Moisture Sensitivity Level	Level 1, JEDEC-J-STD-020D
UHAST	JESD22A-118 , 96 hours, 130°C; 85% relative humidity
IOL	MIL-STD-750 Method 1037

### 10. Package Dimensions

#### TO-220 AB (R- Package) – Non-isolated Mounting Tab Common with Center Lead

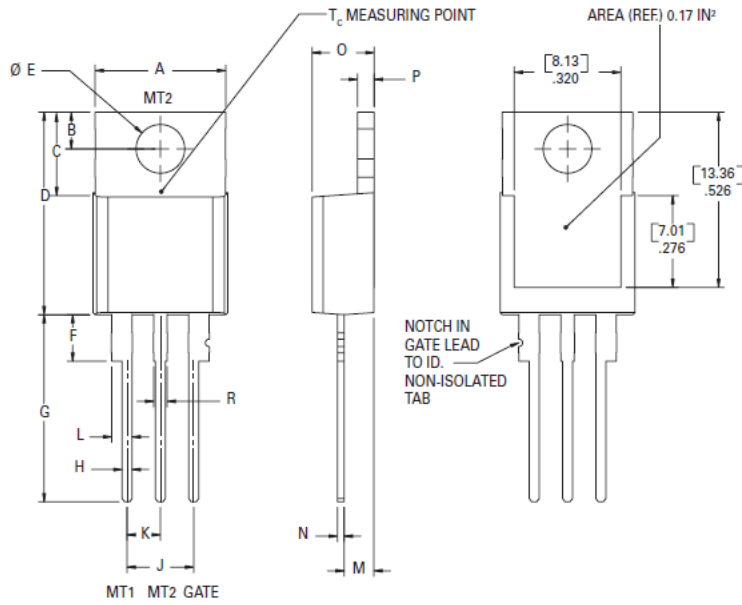

Dimension	Millimeters		Inches	
	Min	Max	Min	Max
A	0.380	0.420	9.65	10.67
B	0.105	0.115	2.67	2.92
C	0.230	0.250	5.84	6.35
D	0.590	0.620	14.99	15.75
E	0.142	0.147	3.61	3.73
F	0.110	0.130	2.79	3.30
G	0.540	0.575	13.72	14.61
H	0.025	0.035	0.64	0.89
J	0.195	0.205	4.95	5.21
K	0.095	0.105	2.41	2.67
L	0.060	0.075	1.52	1.91
M	0.085	0.095	2.16	2.41
N	0.018	0.024	0.46	0.61
O	0.178	0.188	4.52	4.78
P	0.045	0.060	1.14	1.52
R	0.038	0.048	0.97	1.22

Note: Maximum Torque to be applied to mounting tab is 8-in lbs. (0.904 Nm)

#### TO-263 AB (N- Package) – D<sup>2</sup>Pak Surface Mount

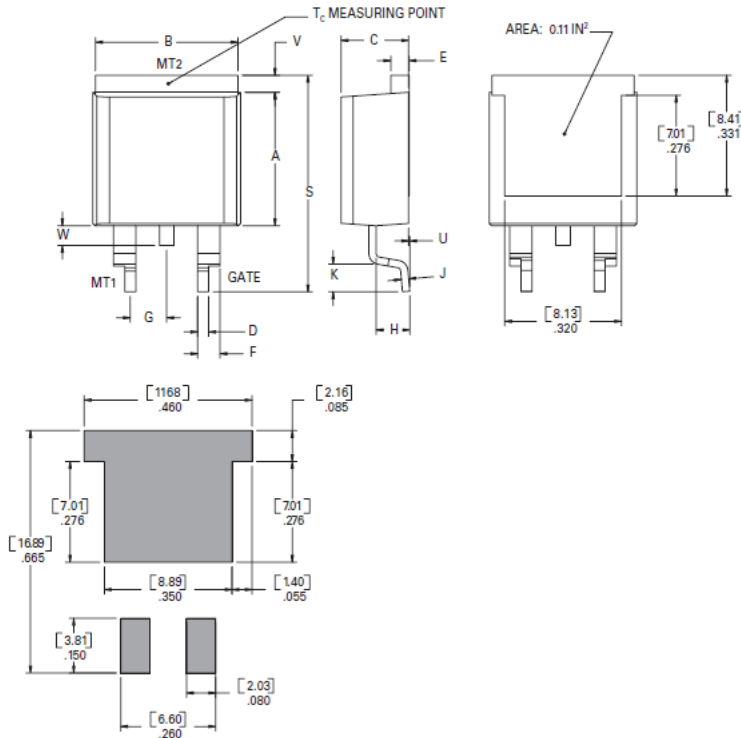

Dimension	Millimeters		Inches	
	Min	Max	Min	Max
A	0.360	0.370	9.14	9.40
B	0.380	0.420	9.65	10.67
C	0.178	0.188	4.52	4.78
D	0.025	0.035	0.64	0.89
E	0.045	0.060	1.14	1.52
F	0.060	0.075	1.52	1.91
G	0.095	0.105	2.41	2.67
H	0.092	0.102	2.34	2.59
J	0.018	0.024	0.46	0.61
K	0.090	0.110	2.29	2.79
S	0.590	0.625	14.99	15.88
V	0.035	0.045	0.89	1.14
U	0.002	0.010	0.05	0.25
W	0.040	0.070	1.02	1.78

### 11. Part Numbering and Marking

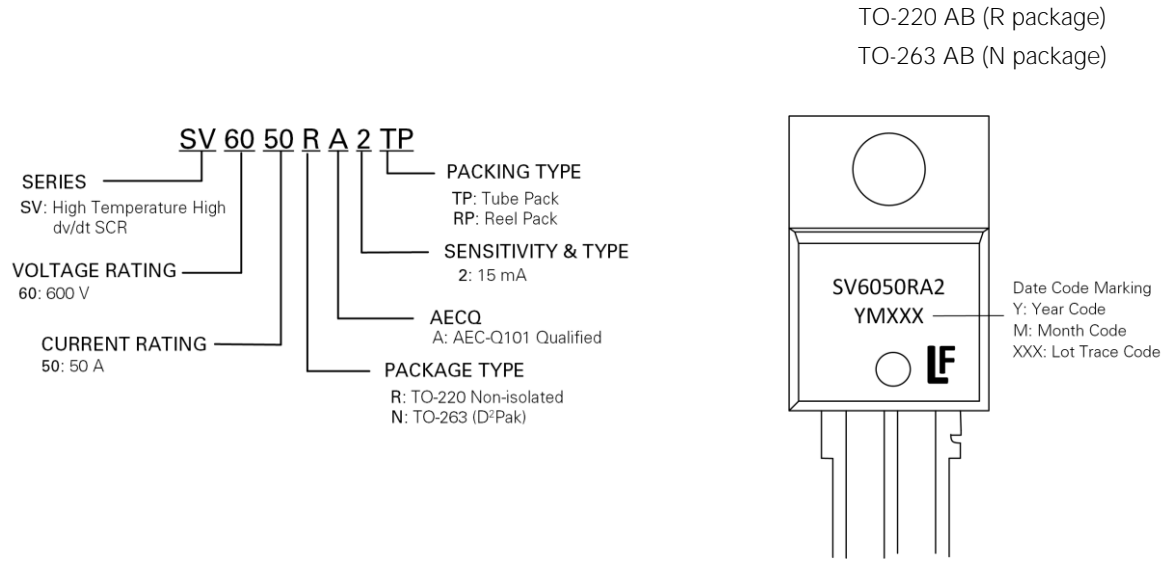

### 12. Product Selector

Part Number	Voltage 600 V	Gate Sensitivity	Type	Package
SV6050RA2TP	X	15 mA	Standard SCR	TO-220R
SV6050NA2TP	X	15 mA	Standard SCR	TO-263
SV6050NA2RP	X	15 mA	Standard SCR	TO-263

### 13. Packing Options

Part Number	Marking	Weight	Packing Mode	M.O.Q
SV6050RA2TP	SV6050RA2	2.2 g	Tube Pack	1000 (50 per tube)
SV6050NA2TP	SV6050NA2	1.6 g	Tube Pack	1000 (50 per tube)
SV6050NA2RP	SV6050NA2	1.6 g	Embossed Carrier	500