

Description

The power distribution system SVS14-10 optimises DC 24 V distribution on the field level in automated process control, industrial production and chemical plants. The system holds an integral ammeter (display 25 A) for the total current and offers ten ways for electronic and thermal-magnetic circuit breakers including group signalling. It allows protection of transformers, actuators, solenoids, peripheral PLCs, intelligent terminals etc. on the field level. Particularly for systems with a great number of sensors/actuators the SVS14 power distribution system enables a space-saving and cost-effective design of protection control cabinets.

Any load circuit which might be disconnected due to overload or short circuit generates a single signal which will be summarised in a group signal directly on the power distribution system and which will be fed back directly to control.

The SVS14 is a track-mountable system and accommodates 10 electronic or thermal-magnetic circuit breakers. All terminals (entry line DC +24 V, GND (-) for self-supply, load outputs L(+) and group signalling are standard screw terminals.

The SVS14 accommodates the following E-T-A types:

Electronic circuit breaker	ESS20-003..
Electronic circuit breaker	ESS30-S003..
Electronic circuit protector	ESX10-103..
Thermal-magnetic circuit breaker	2210-S211 3600-P10, 3900-P10

Ordering information

Type

- SVS14** Power distribution system for ESS20-003, ESS30-S003, ESX10-103
- Short circuit limited DC 24 V applications
 - Max. 25 A cont. load
 - Integral group signalling terminals S2 S1, DC 24 V / max. 0.5 A to be protected separately
 - Integral Si contact (per way) for free slots, Si circuit can be closed
 - Including 2 end pieces X 222 004 01

Version, max. number of circuit breakers

10 10 circuit breakers (F1...F10)

Population option, load output

C22 Fully populated with pcb screw terminals (double level) (max. 4 mm², without wire end ferrule)

Integral ammeter

A01 Ammeter 90° to rail (vertical mounting position) (25 A / class 1.5 % / 48x48)

A02 Ammeter 0° to rail (horizontal mounting position) (25 A / class 1.5 % / 48x48)

Special version

Sxxx

SVS14 - 10 - C22 - A01 Ordering example

Accessories: external jumper and end piece see page "Accessories"



SVS14-10-C22-A01

Technical data (T_{amb} = 25 °C, U_B = DC 24 V)

Application

Modular power distribution system for **current limited** DC 24 V - applications. In the event of current supply rated higher than 25 A and with battery-buffered supplies please use a 25 A protection with medium delay trip curve (e.g. E-T-A type 2210-T).

Supply

Rated voltage:	DC 24 V (18...32 V)
Total current:	max. 25 A
	DC 24 V (+) terminal block X21 2+/1+
	DC 24 V (-) terminal block X21 2-/1-
Terminals:	4-pole screw terminals cable cross section max. 16 mm ² (with and without wire end ferrule)
Gauge:	Ammeter DIN 48, current rating 25 A (moving-iron instrument, 1.5 %)

F ways

Ten ways for circuit breaker, prepared for types ESS20-003, ESS30-S003, ESX10-103, 2210-S211, 3600-P10, 3900-P10
SVS14-10 / 10-way / F1... F10 = terminal X1+/X1-...X10+/X10-

Load outputs per way (F1...F10)

Rated voltage:	DC 24 V (18...32 V)
Current:	max. 8 A per way ¹⁾
Number:	1 protected load output L(+) (at way F1 on terminal X1+) 1 minus return load (at way F1 on terminal X1-)
Terminals:	2-pole double level terminal with screw terminal cable cross section max. 4 mm ² (with and without wire end ferrule)

Signalling

Signal terminal X31 (S2, S1) for group signal	
Rated voltage:	DC 24 V (18...28 V)
Total current:	max. 0.5 A
S1	(Caution: use external protection 0.5 A/fast) External supply possible + DC 24 V for signalling
S2	Signal output, group signal of ways F1...F10
Terminals:	2-pole double level terminal with screw terminal cable cross section max. 4 mm ² (with and without wire end ferrule)

¹⁾ When mounted side-by-side and full population with circuit breakers type ESS20, ESS30, ESX10, 2210, 3600 and 3900 with current rating 10 A, each device should carry only 80 % of its rating.

Technical data ($T_{amb} = 25\text{ °C}$, $U_B = \text{DC } 24\text{ V}$)

Termination

C22	Supply terminal X21: screw terminals max. 16 mm ² - with and without wire end ferrule - stripped length - screw terminals - tightening torque	0.5 - 16 mm ² 10 mm M4 1.2 - 1.5 Nm
	Load outputs terminal X1... X10: double level screw terminals - with and without wire end ferrule - stripped length - screw terminals - tightening torque	max. 4 mm ² 0.25 - 4 mm ² 8 mm M3 0.5 - 0.6 Nm
	Signalling terminal X31: screw terminals max. - with and without wire end ferrule - stripped length - screw terminals - tightening torque	2.5 mm ² 0.25 - 2.5 mm ² 7 mm M3 0.5 - 0.6 Nm

General data

- Mounting: DIN rail to EN 50022 - 35 x 7.5
- Temperature range: 0...50 °C (without condensation)
- Storage temperature: -20...55 °C (-4...+131 °F)
- Housing material: Plastic
- Protection class:
 - Terminals IP20 DIN 40050
 - Pcb IP00 DIN 40050 (double coating)
- Insulation voltage: DC 250 V (pcb)
- Dimensions: see drawings
(tolerances to DIN ISO 286 part 1 IT13)
- Mass: SVS14-10-C22-xxx approx. 600 g

Reference notes

- The power distribution system must be installed by qualified personnel only.
- Only after expert installation may the device be connected to a power supply.
- The device is only suitable for use in safety extra-low voltage (DC 24 V).
- Connection to higher or not reliable disconnected voltages may cause perilous conditions or damages.
- The max. total current of the SVS14 system must not be exceeded.
- In each load circuit the cable cross sections and the current rating of the protective element have to be adjusted to the rating of the connected load.
- The technical data of the circuit breakers used have to be observed.
- According to the "Machinery Directive 2006/42/EG and the norm EN 60204-1, Machine Safety" special precautions have to be taken in machinery (e.g. use of a safety PLC) to prevent inadvertent start-up of machinery parts. In the event of a failure (short circuit/overload) the load circuit will be disconnected by the circuit breaker.
- After tripping of the circuit breaker and before reset the trip cause (short circuit or overload) has to be remedied.
- The international standards (e.g. DIN VDE 0100 for Germany) have to be observed with installation and selection of cables.

Features

- Systematic integration of power distribution, protection and signalling functions
- Power distribution and selective protection of DC 24 V loads from a single source
- Group signalling pre-wired
- Integral Si contact (per way) for free slots, Si circuit can be closed.

Schematic diagram SVS14-10

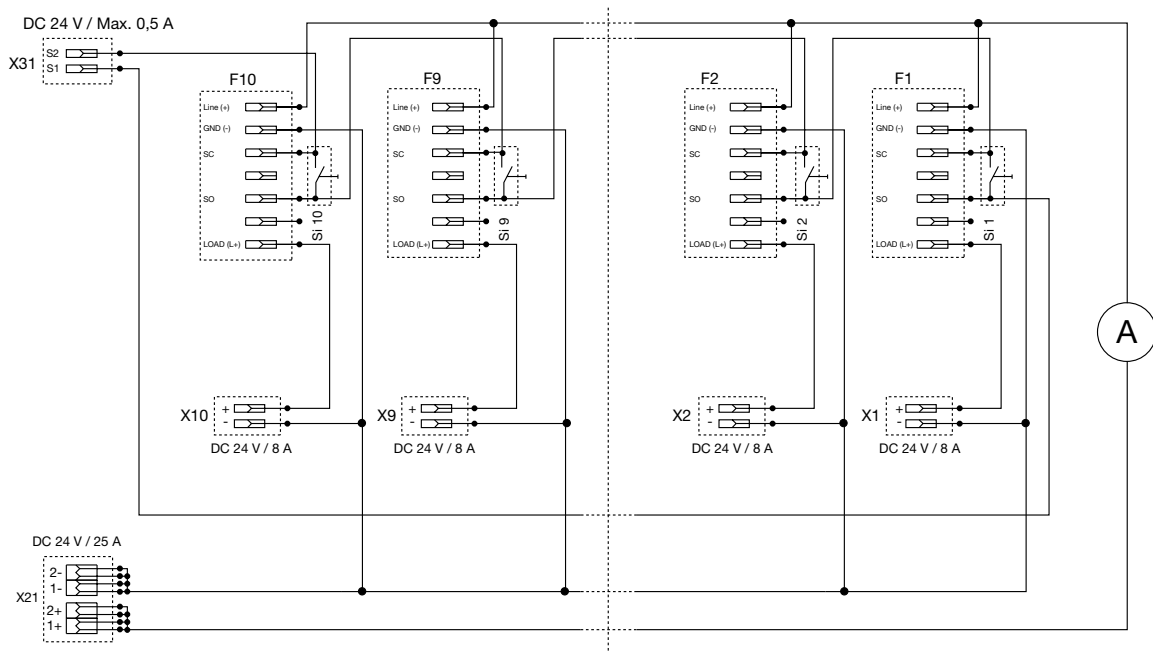

6

Dimensions SVS14-10-C22-A01 (vertical mounting position)

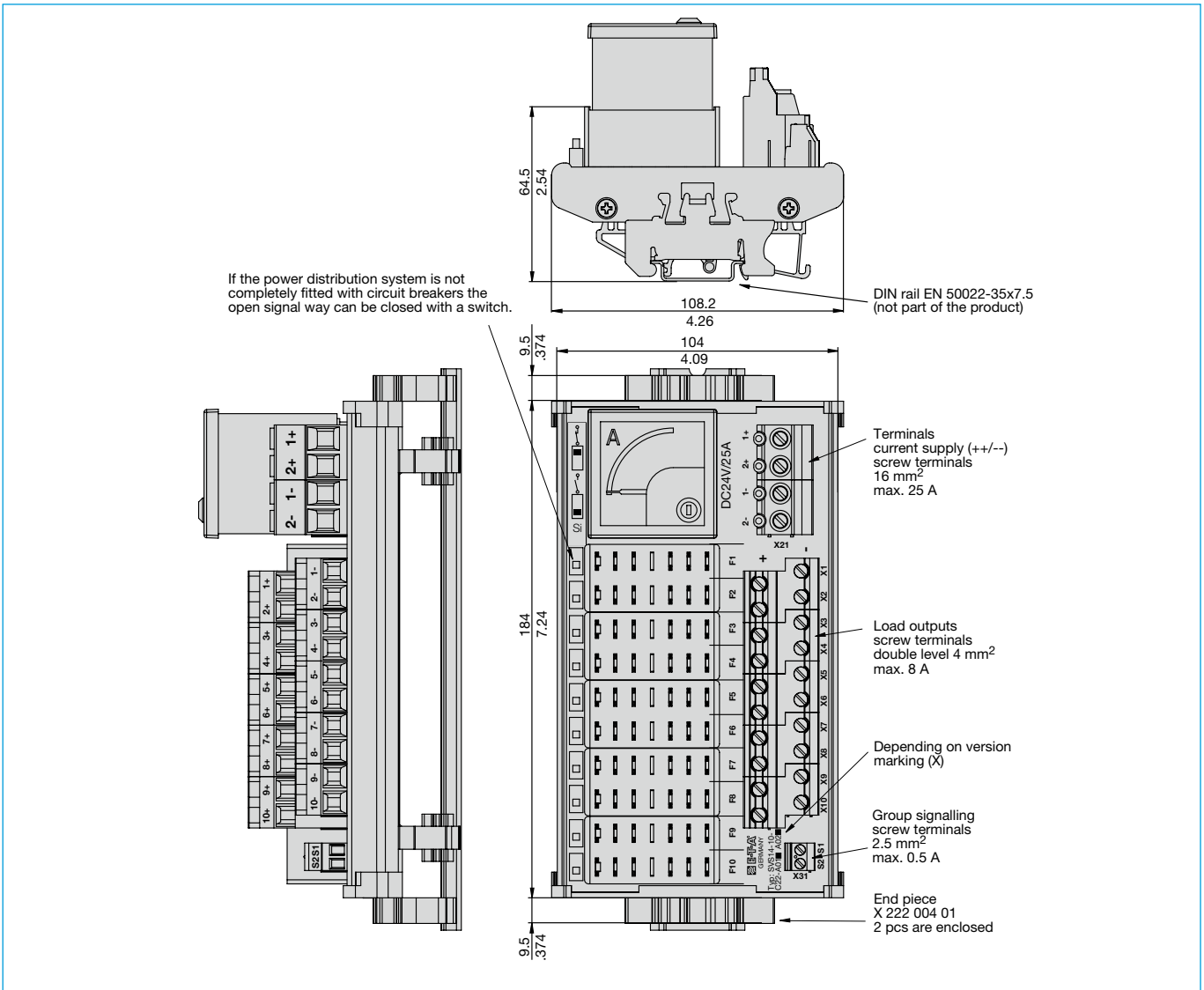

Mounting position SVS14-10-C22-A01 (vertical mounting position)

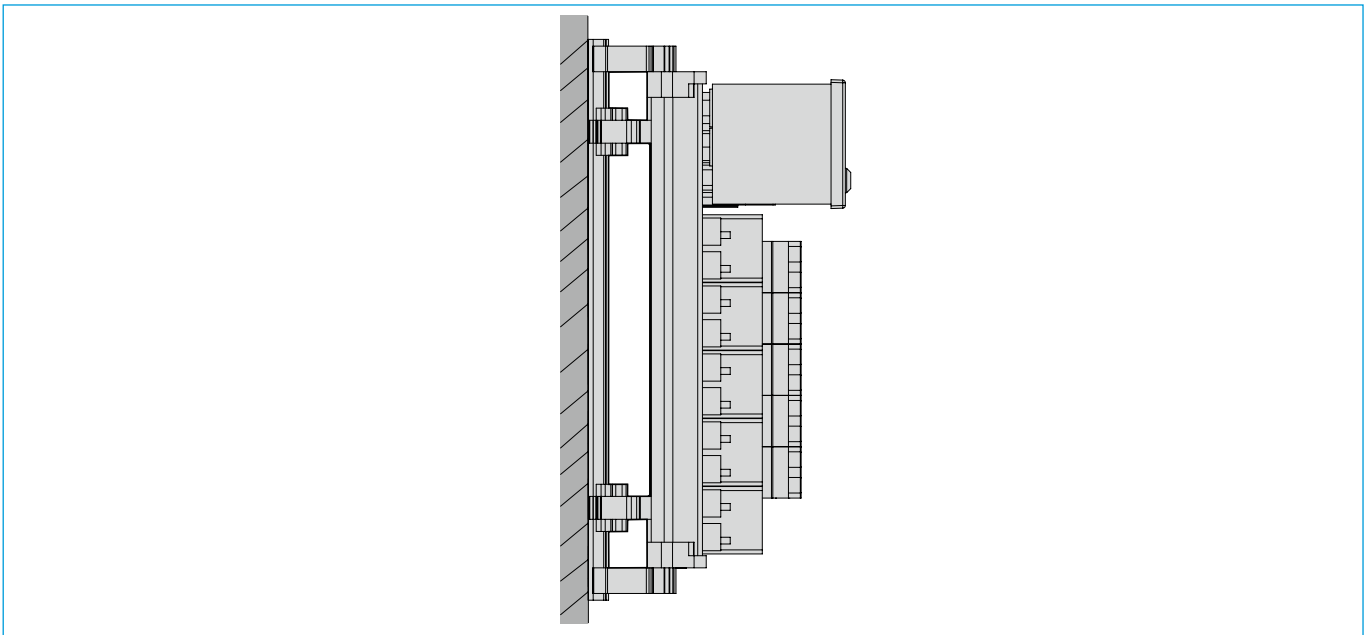

Application example SVS14-10-C22-A01 fitted with ESX10-103

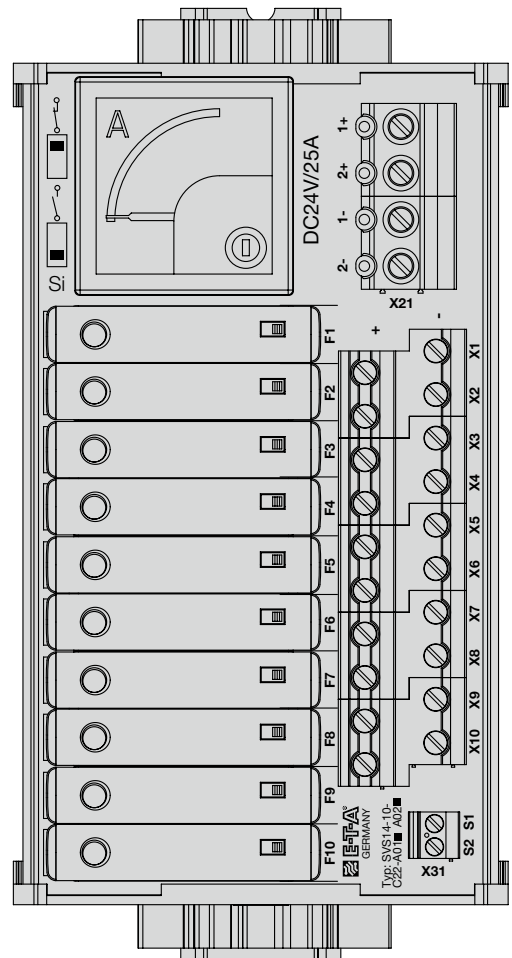
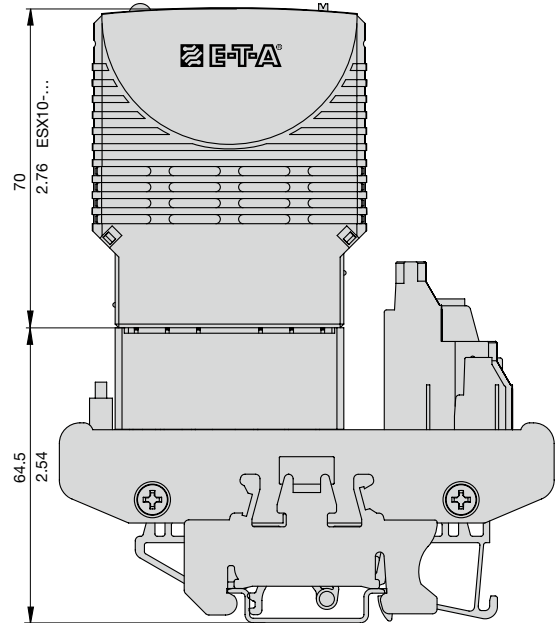
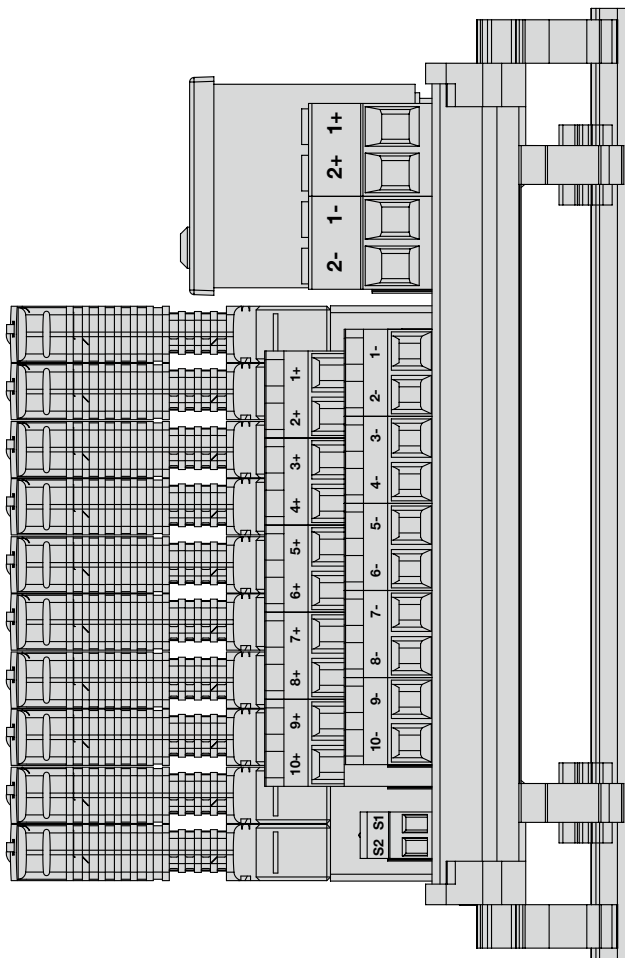

Please order the required population option separately.

Dimensions SVS14-10-C22-A02 (horizontal mounting position)

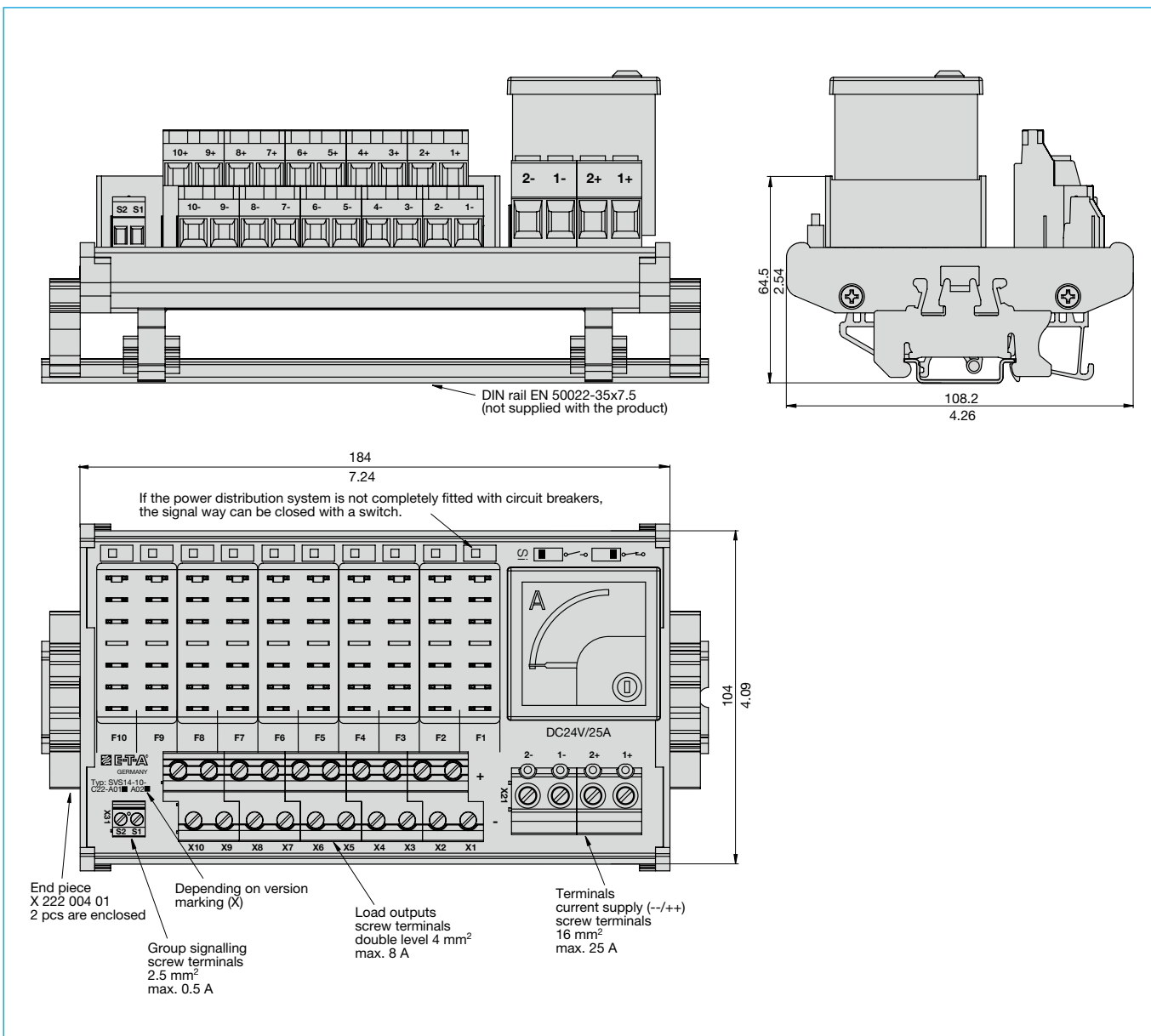

Mounting position SVS14-10-C22-A02 (horizontal mounting position)

