

SX1276 Development Kit

USER GUIDE



Table of Contents

Table of Contents	2
Index of Figures	3
1 Preamble.....	4
2 Introduction	4
3 Getting Started.....	5
3.1 Evaluation Kit Contents.....	5
3.2 Ordering information	6
3.3 Updating the firmware.....	6
4 Eiger Platform Presentation.....	6
4.1 Platform Description.....	10
4.2 SX1276 Module Hardware.....	11
4.2.1 SX1276RF1IAS.....	11
4.2.2 SX1276RF1JAS.....	12
4.2.3 SX1276RF1KAS.....	13
4.2.4 Module Antenna	14
5 Eiger platform for PER Testing.....	15
5.1 Menu Description	15
5.2 Using the Eiger platform.....	15
5.2.1 System Window.....	16
5.2.2 PER Demo Window	19
5.2.3 PER Rx Bar-graph	28
6 SX1276SKA Software Description.....	29
6.1 SX1276SKA Quick start Guide	29
6.2 LoRa Mode.....	32
6.2.1 LoRa Menu.....	32
6.2.2 LoRa Common Window	33
6.2.3 LoRa Parameters Window	34
6.3 FSK Mode	35
6.3.1 FSK Menu	35
6.3.2 Common window.....	36
6.3.3 Transmitter window	37
6.3.4 Receiver window	38
6.3.5 IRQ and Map window.....	39
6.3.6 Packet Handler window.....	40
6.3.7 Sequencer window.....	41
6.3.8 Temperature window.....	42
7 How to.....	43
7.1 ... perform a simple transmission / reception in LoRa	43
7.2 ... perform a simple transmission / reception in FSK.....	45
7.3 ... perform Continuous transmission and Reception in LoRa.....	49
7.4 ... Log the Transmitted or Received packets.....	50
7.5 ... perform a CW or PN9 Tx test on the SX1276	51
7.6 ... check the frequency accuracy of the SX1276 module	51
8 Troubleshooting	52
8.1 The Eiger platform indicates very high PER even in short range	52
8.2 The communication range in Lora is very poor.....	52
8.3 The SX1276SKA do not detect the device through the USB.....	52
8.4 The Eiger platform does not seem to work anymore	52
8.5 The Eiger platform touch screen is not accurate	52

Index of Figures

Figure 1: SX1276 Development Kit.....	5
Figure 2: Eiger platform description	10
Figure 3: SX1276RF1IAS Module Schematic.....	11
Figure 4: SX1276RF1JAS Module Schematic.....	12
Figure 5: SX1276RF1KAS Module Schematic	13
Figure 6: LF and HF Antenna Connection	14
Figure 7: Frequency Band Targeted Antenna.....	14
Figure 8: Connect both USB ports to use the SX1276SKA	29
Figure 9: SX1276 window organization	30
Figure 10: Register table.....	31
Figure 11: SX1276SKA Boot-up windows	33
Figure 12: LoRa Radio parameters window.....	34
Figure 13: FSK window structure	35
Figure 14: FSK Common window	36
Figure 15: FSK Transmitter window.....	37
Figure 16: FSK Receiver window.....	38
Figure 17: FSK IRQ and Map window	39
Figure 18: FSK Packet Handler window	40
Figure 19: FSK Sequencer window	41
Figure 20: FSK Temperature window	42

1 Preamble

This document describes how to use the SX1276 Evaluation kit. This document describes especially the SX1276 Eiger platform and the SX1276SKA User Interface. We strongly recommend for the user to read thoroughly the datasheet of the SX1276 prior to start working on the device. Most of this document assumes a general knowledge on the SX1276 and modern RF communications.

2 Introduction

The SX1276 is a single-chip integrated circuit ideally suited for today's high performance ISM band RF applications. Added to the renowned, high-performance and low-cost, FSK / OOK RF transceiver modem, the SX1276 is also equipped with the LoRa proprietary transceiver modem. This advanced feature set, including a state of the art packet engine, greatly simplifies system design whilst the high level of integration reduces the external BOM to a handful of passive decoupling and matching components. It is intended for use as high-performance, long range, half-duplex bi-directional RF links, and where stable and constant RF performances are required over the full operating range of the device down to 1.8V.

The SX1276 is intended for applications over a wide frequency range and it is covering all available sub-1GHz frequency bands (168MHz, 434MHz, 470MHz, 868MHz and 902MHz). Coupled with a link budget in excess of 135 dB in FSK in excess of 155 dB in LoRa, the SX1276 really offers the possibility of two modems in one single package. The SX1276 complies with both ETSI and FCC regulatory requirements and is available in a 5x5 mm QFN 28 lead free package.

The SX1276 Evaluation kit, based around the Eiger platform, allows the user to test every aspect of the radio, both from the system and RF point of view.

On one hand, the Eiger platform is a touch screen portable device which has been design to enable quick and easy testing of the PER performances of the SX1276. On the other hand, the SX1276SKA is a PC based evaluation tool which allows in depth testing of the radio.

This document is therefore divided in two parts: the first part present the SX1276 Eiger module and how to perform PER test in LoRa and FSK; the second part of this document present the SX1276 SKA and how it can be used to test every single aspect of the radio.

3 Getting Started

3.1 Evaluation Kit Contents

The SX1276DVK1 Development Kit consists of:

- 2 x SX1276RF1 modules
- 2 x Eiger platforms
- 2 x dipole antennas for LF frequency band
- 2 x dipole antennas for HF frequency band
- 2 x Mini-USB cables
- 2 x Touch Screen Styluses
- Disclaimer Note



Figure 1: SX1276 Development Kit

3.2 Ordering information

Each of part of the SX1276 Evaluation kit can be ordered as a single entity or in a whole package. When ordering, please refer to the following parts numbers:

SX1276DVK1IAS	SX1276 Development Kit - 169/868MHz version with TCXO
SX1276DVK1JAS	SX1276 Development Kit - 433/868MHz version with XTAL
SX1276DVK1KAS	SX1276 Development Kit - 490/915MHz version with XTAL
SX1276RF1IAS	SX1276 Evaluation Module - 169/868MHz version with TCXO + Antennas
SX1276RF1JAS	SX1276 Evaluation Module - 433/868MHz version with XTAL + Antennas
SX1276RF1KAS	SX1276 Evaluation Module - 490/915MHz version with XTAL + Antennas

For more information on each of the options available, please, contact your local Semtech representative. The SX1276SKA evaluation software, the firmware, drivers and all SX1276 related materials are available on the Semtech website: <http://www.semtech.com/wireless-rf/rf-transceivers/>

3.3 Updating the firmware

Updating the Eiger platform firmware is straight forward given that the user follows some simple steps. The first step is to install the Eiger platform drivers on the PC used to update the firmware. These drivers, called RLink USB drivers are located in the folder RLinkDrv given with every version of the firmware. To install the driver, simply launch the file RLinkUSBInstall.exe.

Once the RLink drivers are installed, the firmware upgrade is done through the update.bat file which will upload the correct version of the firmware depending on several options related to the Eiger platform or module being used. When launching the application, the following window opens:

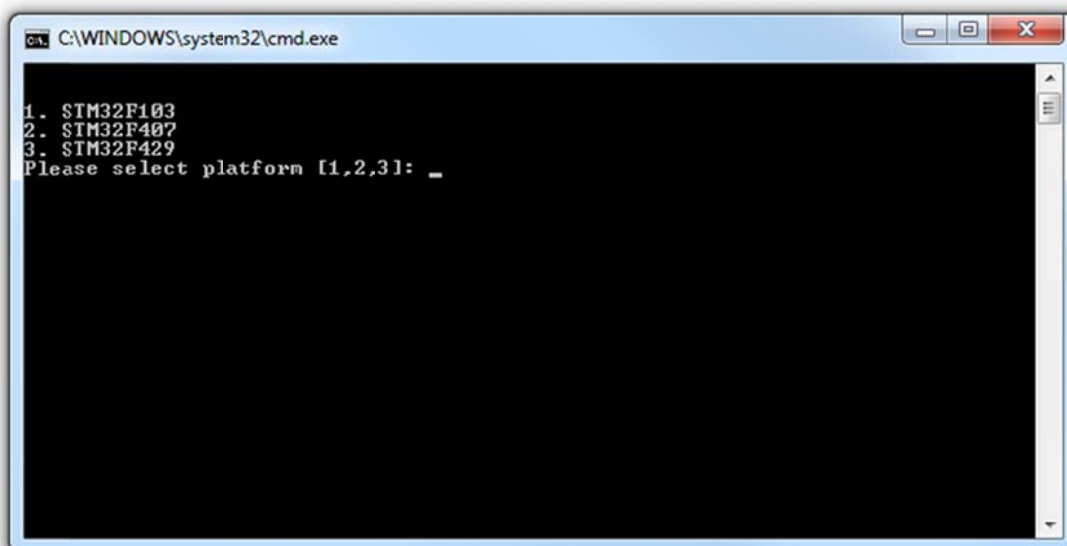

This window invites the user to select the STM32 daughter board fitted on the Eiger platform. The pictures below should help the user to recognize which daughter board is which. Added to this, the STM32F407 daughter board is equipped with a small camera clearly visible at the back of the module. To finish, the STM32F429 is easily identifiable thanks to the size of its MCU.



STM32F103 Module



STM32F407 Module



STM32F429 Module

If the Eiger platform is not powered up, is wrongly connected or if the RLink drivers are not installed, the following message will be displayed on the screen:

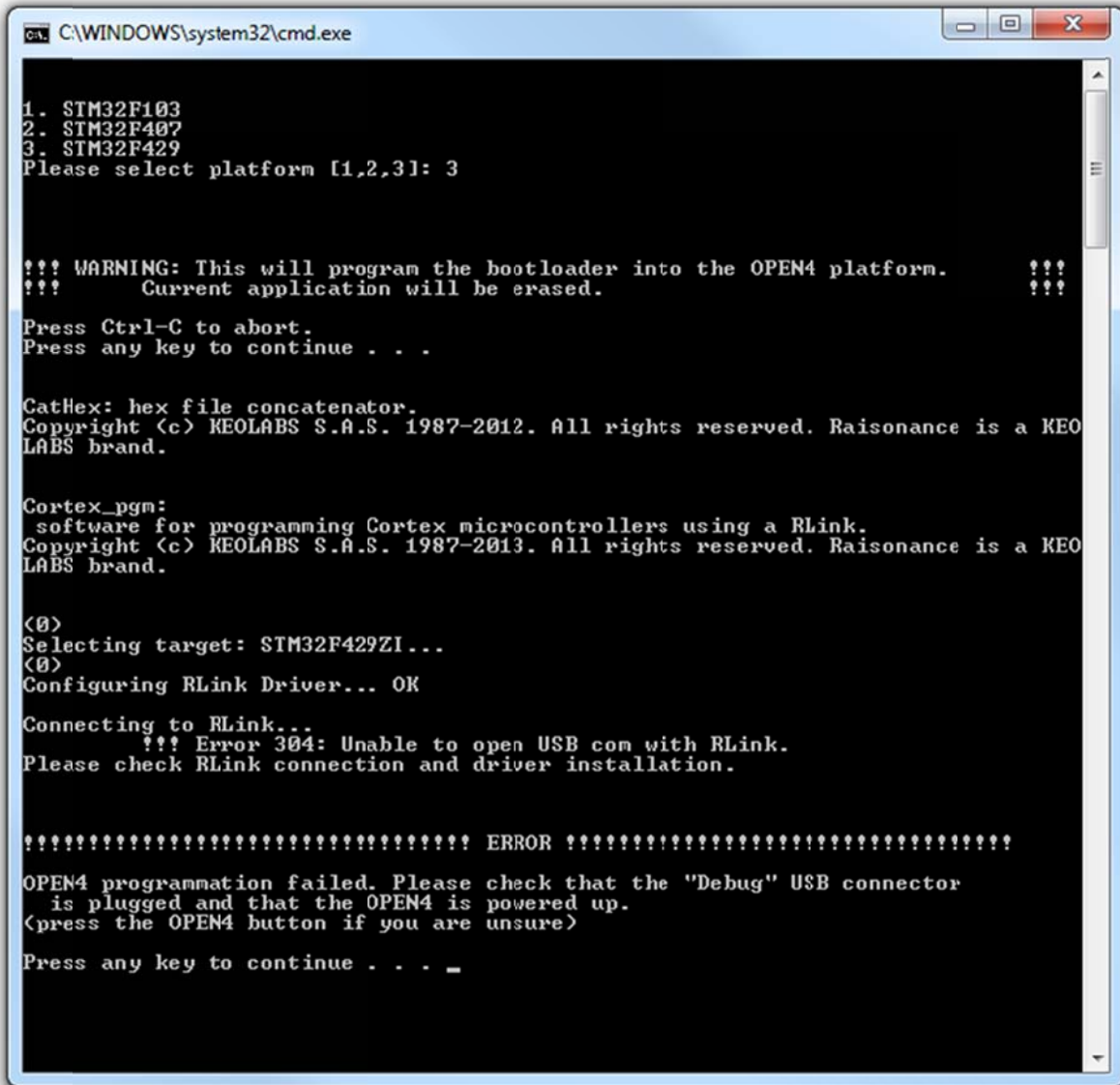

```
C:\WINDOWS\system32\cmd.exe

1. STM32F103
2. STM32F407
3. STM32F429
Please select platform [1,2,3]: 3

!!! WARNING: This will program the bootloader into the OPEN4 platform.     !!!
!!! Current application will be erased.                                     !!!

Press Ctrl-C to abort.
Press any key to continue . . .

CatHex: hex file concatenator.
Copyright (c) KEOLABS S.A.S. 1987-2012. All rights reserved. Raisonance is a KEO
LABS brand.

Cortex_pgm:
 software for programming Cortex microcontrollers using a RLink.
Copyright (c) KEOLABS S.A.S. 1987-2013. All rights reserved. Raisonance is a KEO
LABS brand.

<0>
Selecting target: STM32F429ZI...
<0>
Configuring RLink Driver... OK

Connecting to RLink...
      !!! Error 304: Unable to open USB com with RLink.
Please check RLink connection and driver installation.

!!!!!!!!!!!!!!!!!!!!!!!!!!!!!!!!!!!!!!!!!!!!!!!!!!!!!! ERROR !!!!!!!!!!!!!!!!!!!!!!!!!!!!!!!!!!!!!!!!!!!!!!!!!!!!!!!

OPEN4 programmation failed. Please check that the "Debug" USB connector
 is plugged and that the OPEN4 is powered up.
<press the OPEN4 button if you are unsure>

Press any key to continue . . . _
```

In this situation, the user need to make sure the device is correctly powered and turned on. Please, refer to section 4.1 of this document for more information.

This is what the full upgrader should look like at the end of the software update.

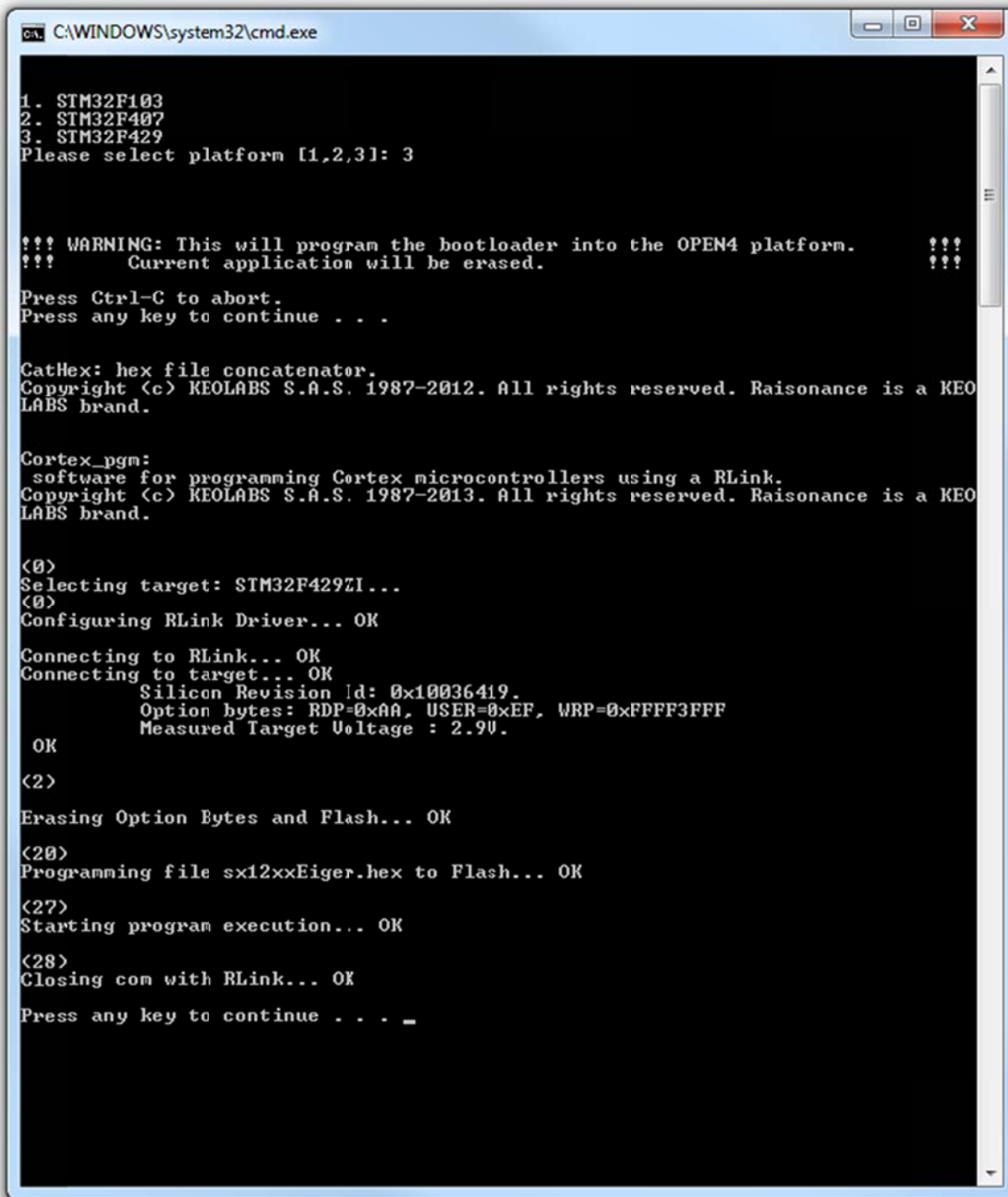

```
C:\WINDOWS\system32\cmd.exe
1. STM32F103
2. STM32F407
3. STM32F429
Please select platform [1,2,3]: 3

!!! WARNING: This will program the bootloader into the OPEN4 platform.   !!!
!!! Current application will be erased.                                 !!!

Press Ctrl-C to abort.
Press any key to continue . . .

CatHex: hex file concatenator.
Copyright (c) KEOLABS S.A.S. 1987-2012. All rights reserved. Raisonance is a KEO
LABS brand.

Cortex_pgm:
software for programming Cortex microcontrollers using a RLink.
Copyright (c) KEOLABS S.A.S. 1987-2013. All rights reserved. Raisonance is a KEO
LABS brand.

<0>
Selecting target: STM32F429ZI...
<0>
Configuring RLink Driver... OK

Connecting to RLink... OK
Connecting to target... OK
Silicon Revision Id: 0x10036419.
Option bytes: RDP=0xAA, USER=0xEF, WRP=0xFFFF3FFF
Measured Target Voltage : 2.9V.

OK

<2>
Erasing Option Bytes and Flash... OK

<20>
Programming file sx12xxEiger.hex to Flash... OK

<27>
Starting program execution... OK

<28>
Closing com with RLink... OK

Press any key to continue . . . _
```

Once the software has been upgraded, it is recommended to reset all the internal settings on the Eiger platform. For more information on how to achieve this, please, refer to section 5.2.1.1 of this document.

4 Eiger Platform Presentation

4.1 Platform Description

The Eiger platform is intended to enable a quick and easy range test of the sx1276 module. Here most of the modem parameters are pre-configured and the user only needs to set some RF parameters.

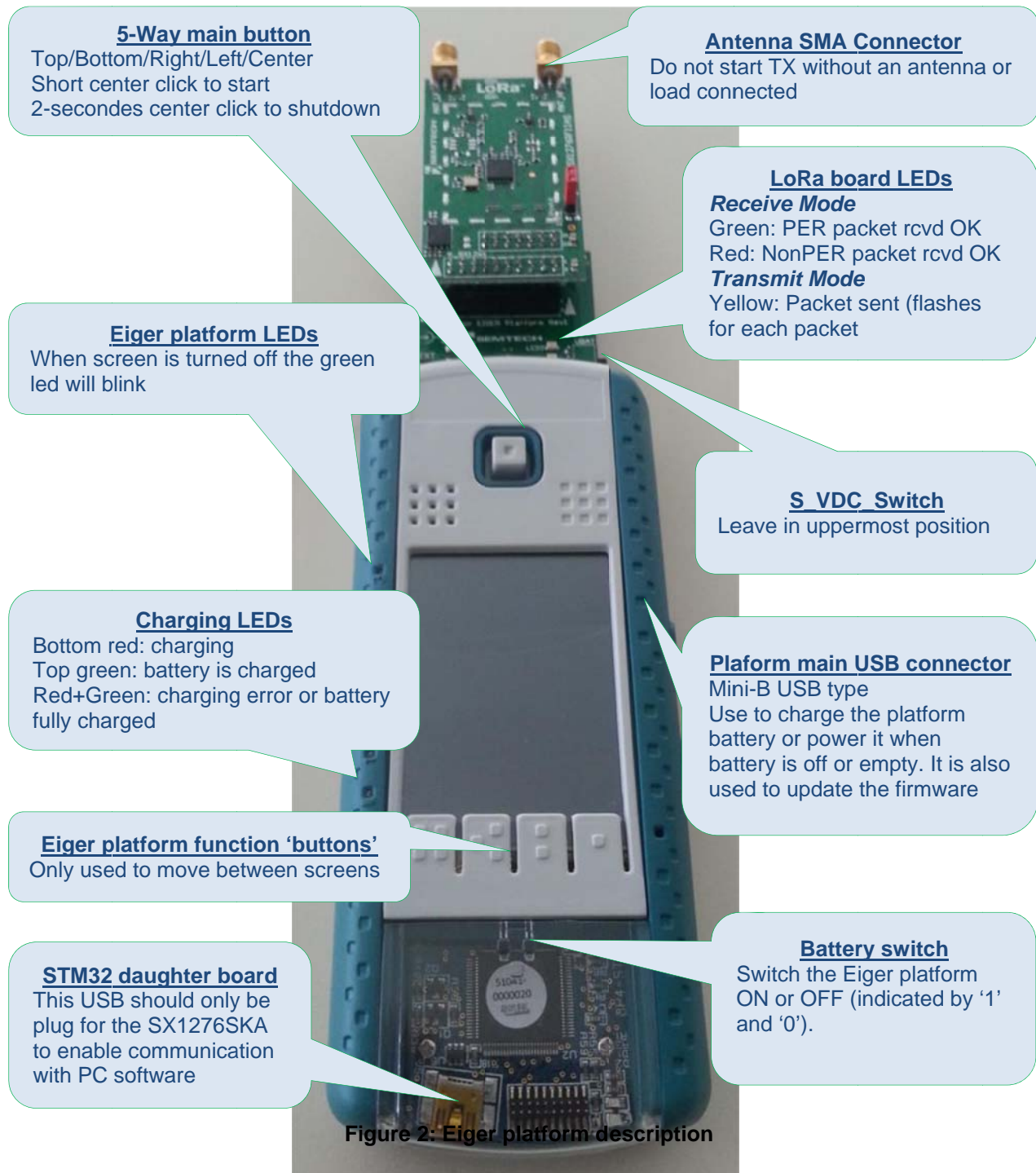

Figure 2: Eiger platform description

4.2 SX1276 Module Hardware

The SX1276DKV is a USB based evaluation software designed to allow simple and easy evaluation of the suitability of the SX1276 for a given application. There are three evaluation module developed around the SX1276 and each module is targeted to specific RF Bands.

4.2.1 SX1276RF1IAS

The SX1276RF1IAS is targeted to the 169MHz and 868MHz frequency bands.

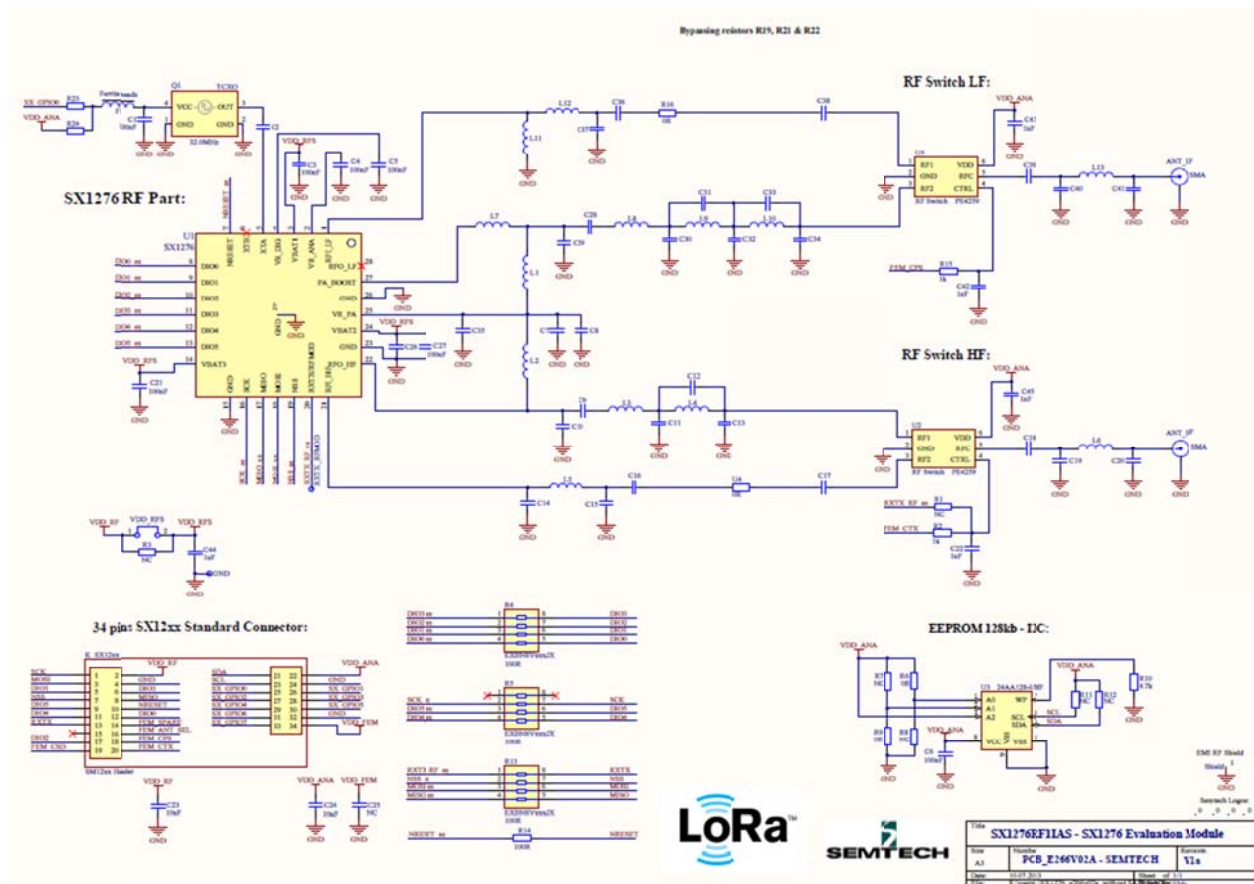

Figure 3: SX1276RF1IAS Module Schematic

4.2.2 SX1276RF1JAS

The SX1276RF1JAS is targeted to the 433MHz and 868MHz frequency bands.

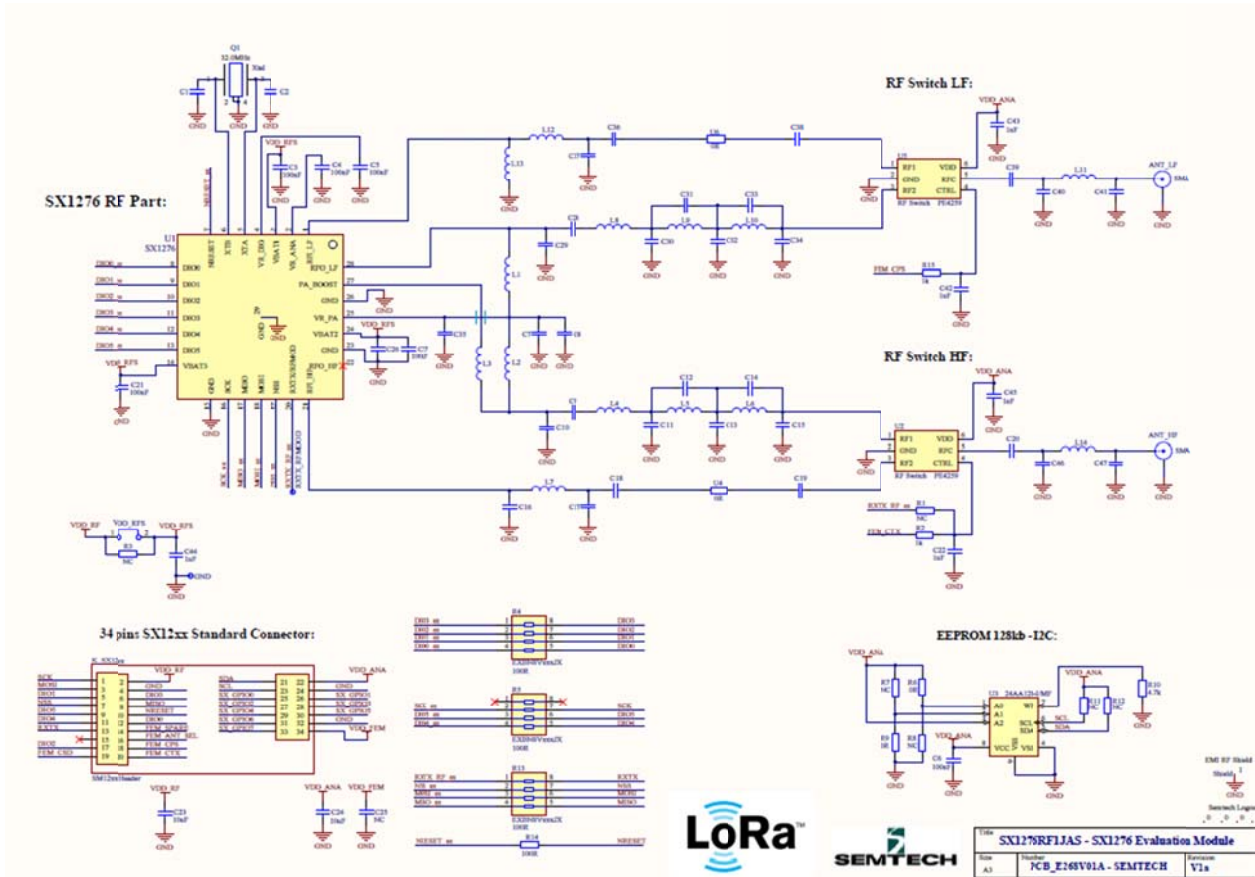

Figure 4: SX1276RF1JAS Module Schematic

4.2.3 SX1276RF1KAS

The SX1276RF1KAS is targeted to the 490MHz and 915MHz frequency bands.

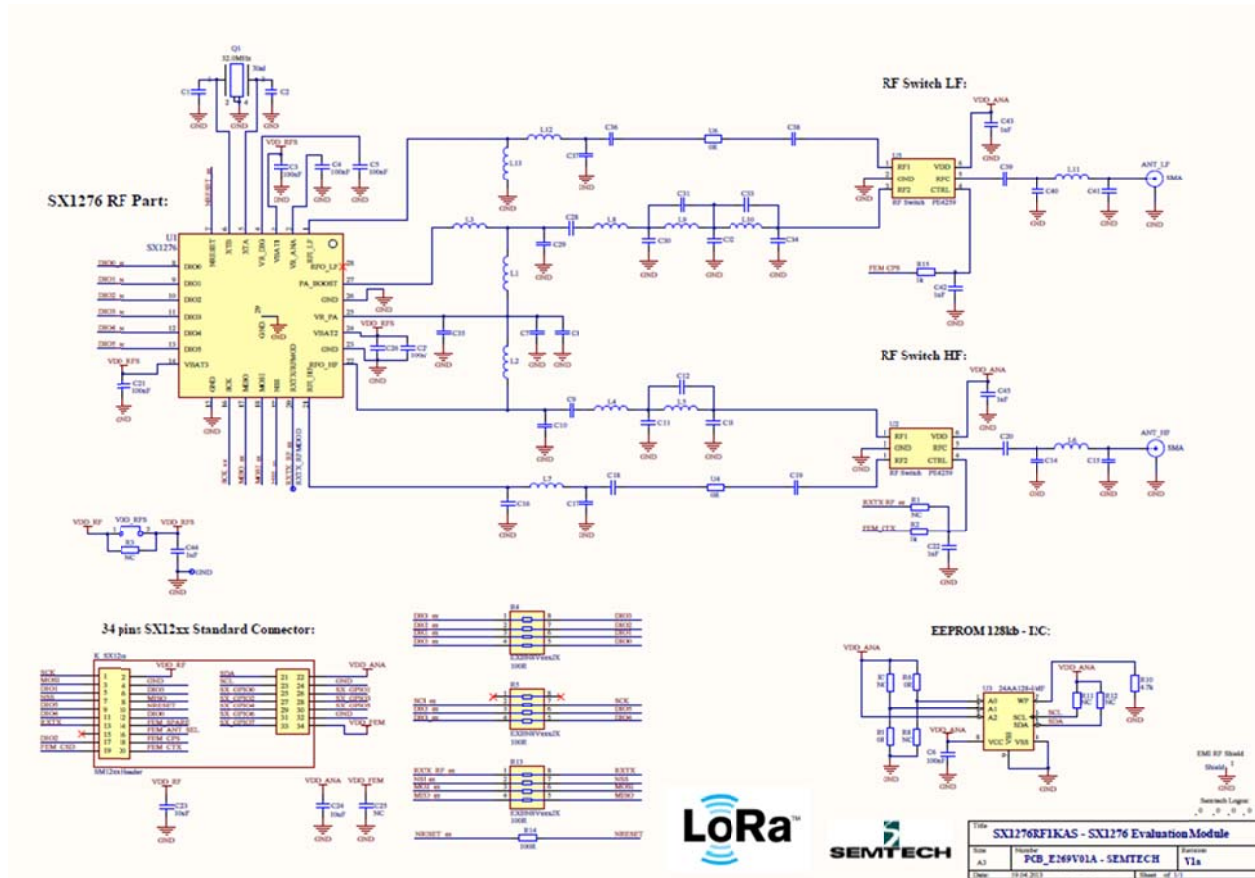

Figure 5: SX1276RF1KAS Module Schematic

4.2.4 Module Antenna

The SX1276RF1 modules are fitted with 2 RF antenna SMA connectors. Each antenna connection has been specifically designed to offer the best RF matching to a specific frequency band.



Figure 6: LF and HF Antenna Connection

Five antennas types could be delivered with kits. The antennas can be identified through their color dedicated or shape, to a specific frequency band (LF=169, 433 or 490MHz, HF=868 and 915 MHz). Antenna types and part numbers are subject to be changed.

[Do not connect both antenna types at the same time on the module.](#)



Figure 7: Frequency Band Targeted Antenna

5 Eiger platform for PER Testing

5.1 Menu Description

The Eiger menu is organized around the touch screen which allows the user to set on the fly a limited number of parameters. We will here describe each menu window so that the user can quickly start doing PER testing.

The idea behind the PER demo is to set one of the Eiger platform as a transmitter and the other one as a receiver. Then both platforms can be moved away one from the other, in an urban or in an open field environment, to easily capture the PER between the transmitter and the receiver.

The PER demo operates in FSK or in LoRa modes so that the advantages and drawbacks of each modulation can be seen easily.

5.2 Using the Eiger platform

When booting up, the Eiger application will detect the hardware module connected to configure the RF parameters dedicated to each module. Each hardware module is fitted with an EEPROM which is programmed at manufacturing. However, if for any reasons, the EEPROM cannot be read or has not been programmed, the following window is shown.

In case of doubt, the exact part number of the hardware module connected is written on the right side of the module.

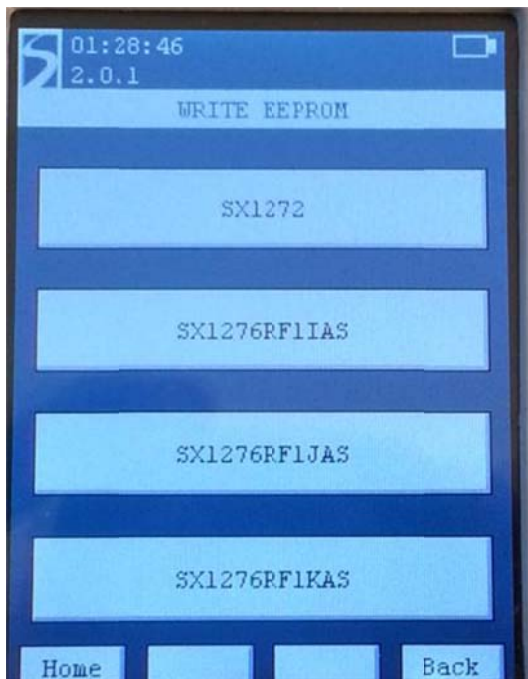

WIRELESS, SENSING & TIMING PRODUCTS

When the module is successfully detected, the home screen is the first window displayed on the control touch screen.

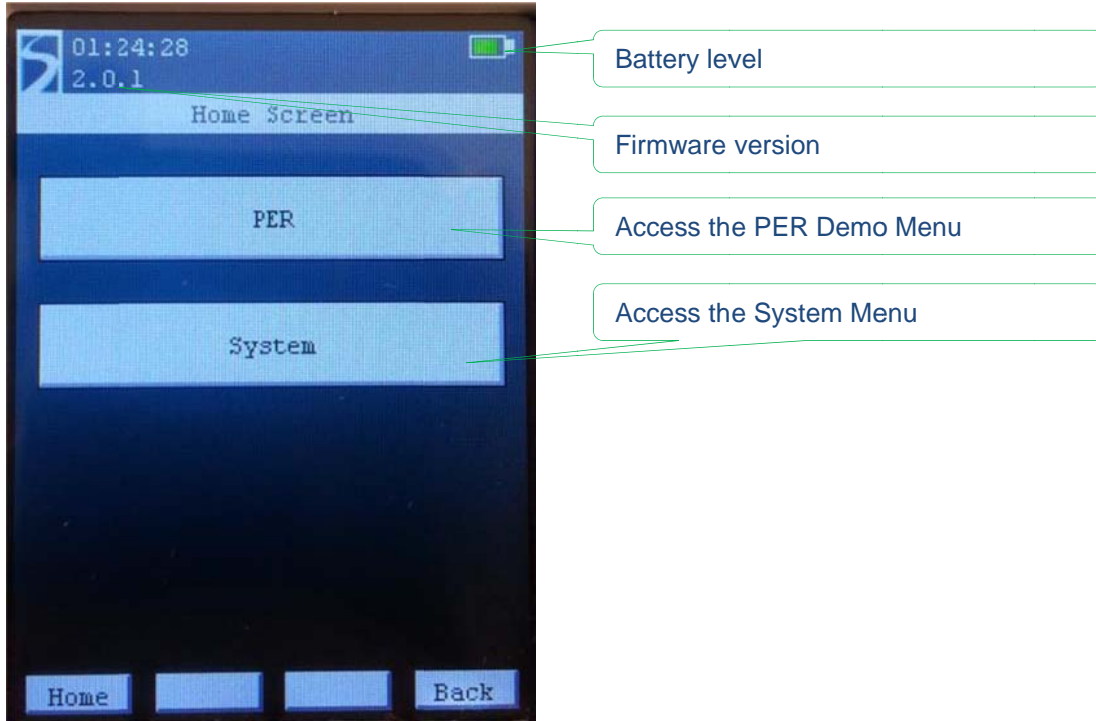

5.2.1 System Window

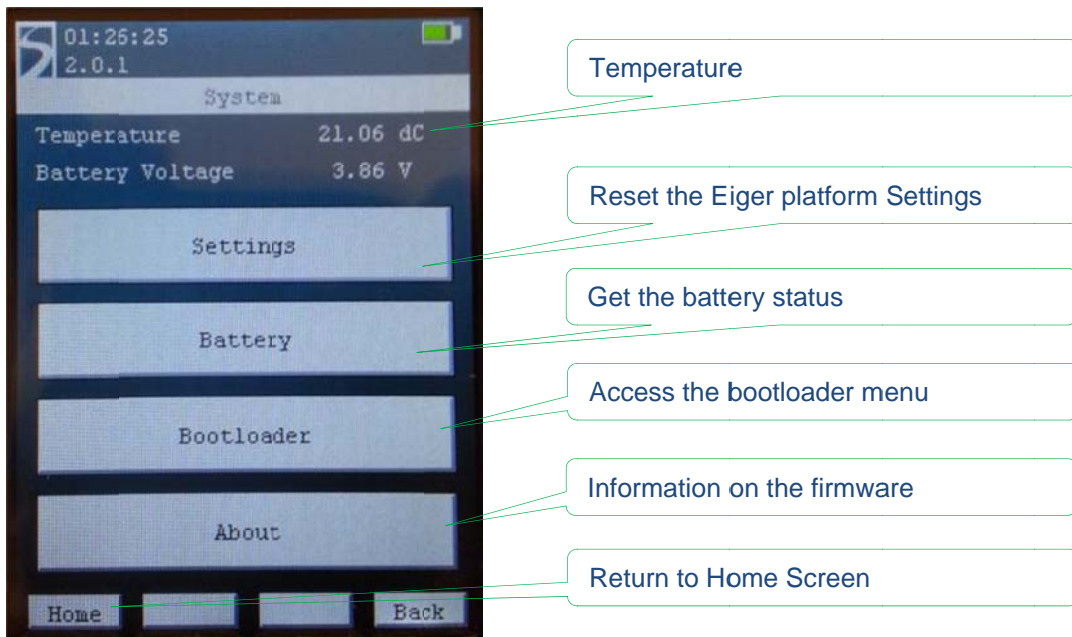

WIRELESS, SENSING & TIMING PRODUCTS

In case of miss-operation or to simply reset the Eiger module into a known state, it is possible the reset the touch screen parameters or to reset the device parameters to their default parameters.

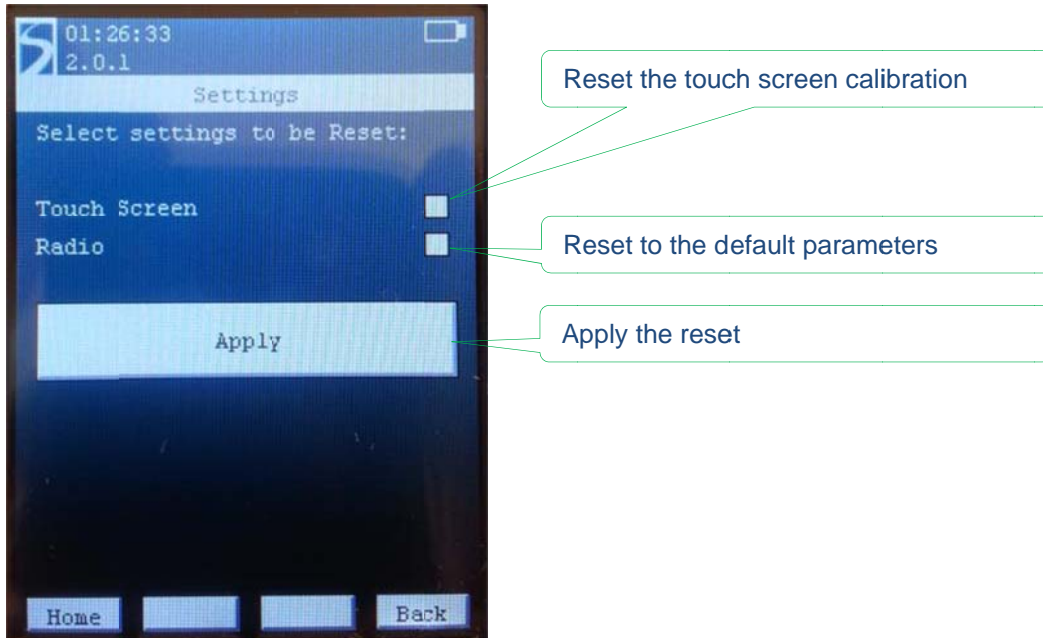

Once a box is ticked, “clicking” on the Apply button will reset the selected parameters. The ticked box will then go un-ticked.

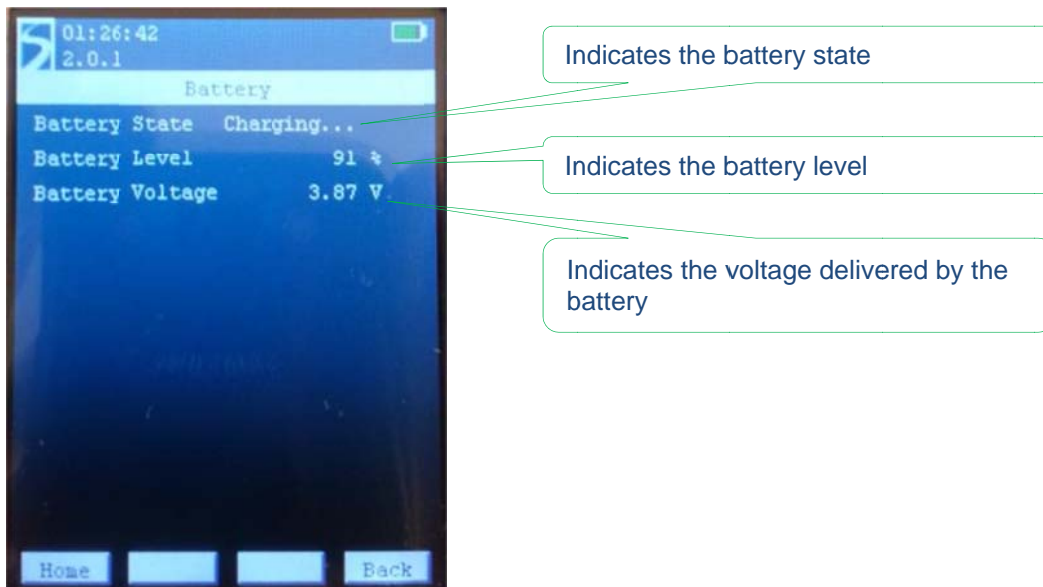
5.2.1.2 Battery

5.2.1.3 Bootloader

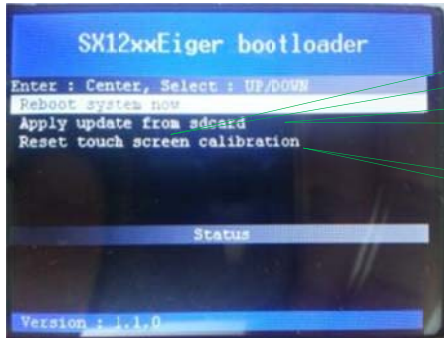

Reboot the system

Update the firmware through an SD card

Reset touch screen calibration

5.2.1.4 About

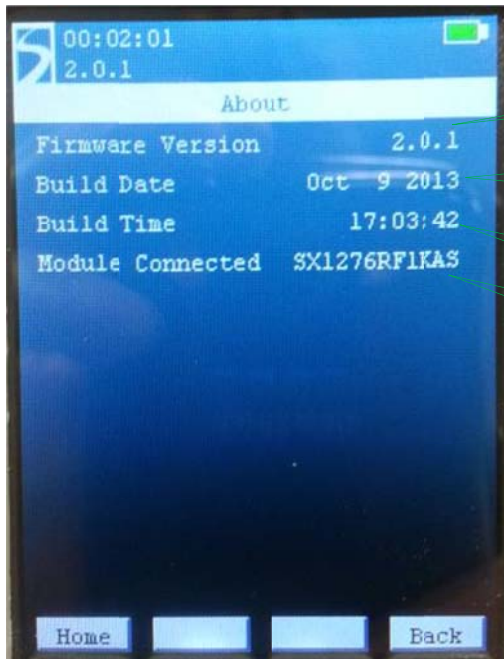

Indicates the Firmware version

Indicates the Build date

Indicates the Build time

Indicates the Module Connected

5.2.2 PER Demo Window

When entering the PER Demo Windows, the EEPROM on the module type is read so that the module connected can be used. If the EEPROM is faulty, not present or damaged, the following windows is displayed.

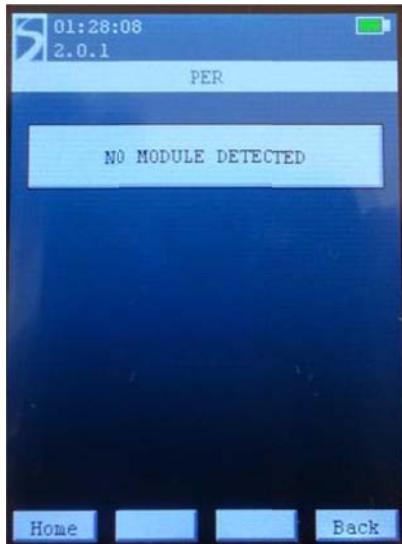

If the module is detected correctly, the PER demo is accessed and the following window is displayed.

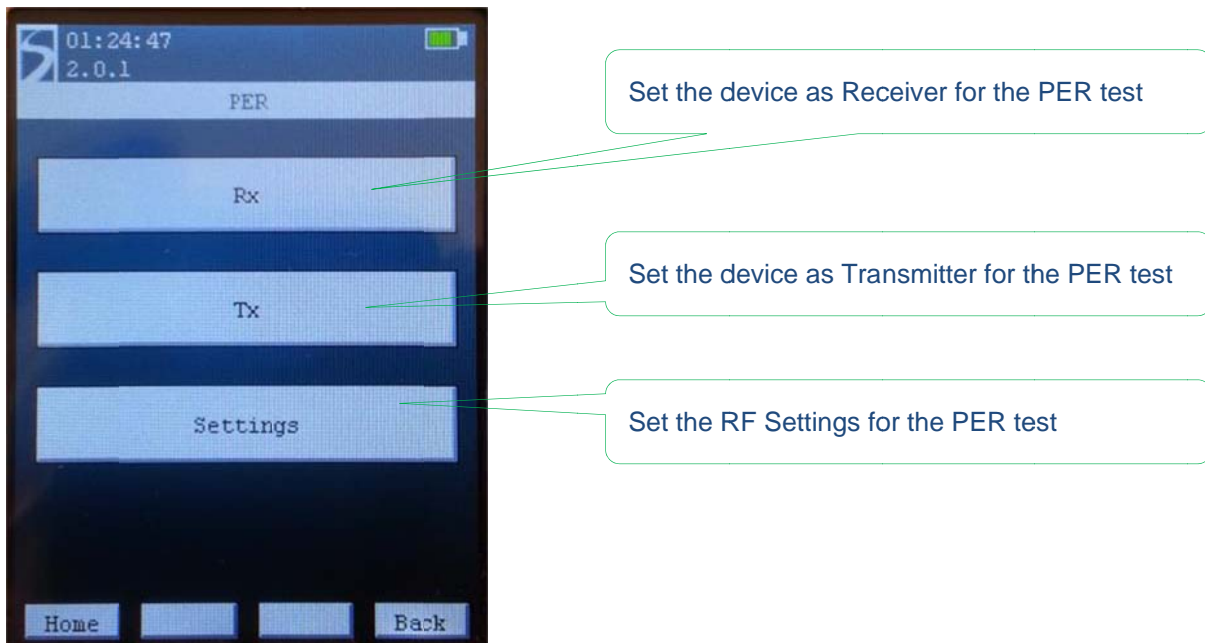

The PER Demo menu is the core of the Eiger platform testing. The menu is divided in three main areas, Tx, Rx and Settings. The PER Settings menu allows the user to set several parameters of the Radio for Tx and Rx.

A text in green indicates that the value can be changed. For example, on the first window of the PER Setting screen, you will see:

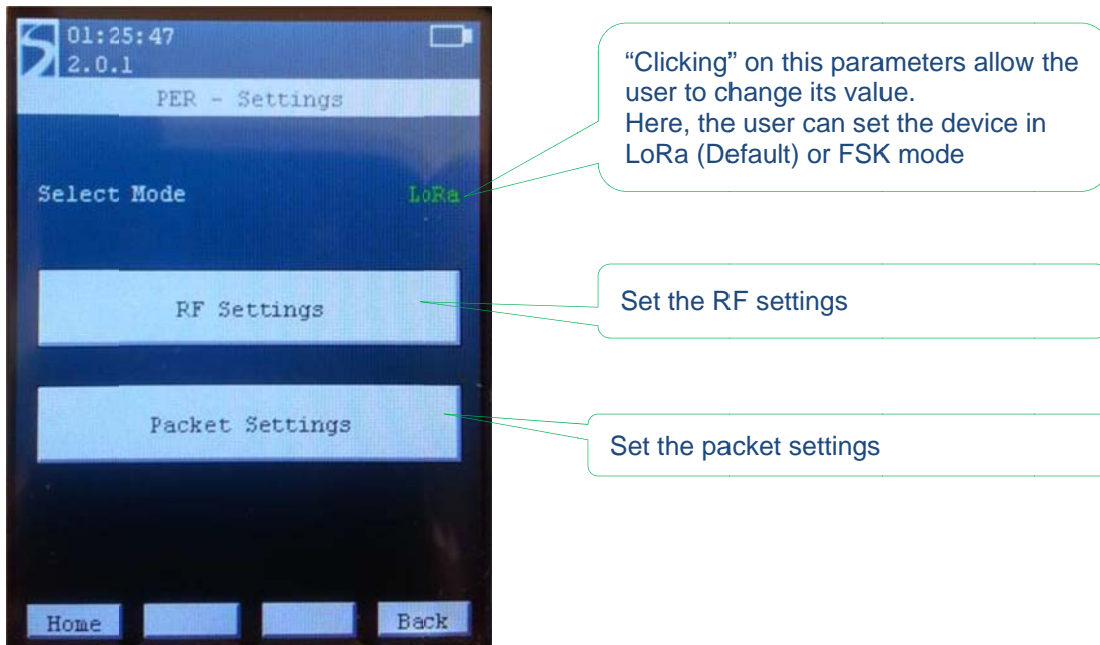

5.2.2.1 PER Settings Menu running in FSK mode

For a given modulation, there is only a limited set of parameters that can be set by the user. Most of the parameters are set automatically in the software to keep the interface user friendly.

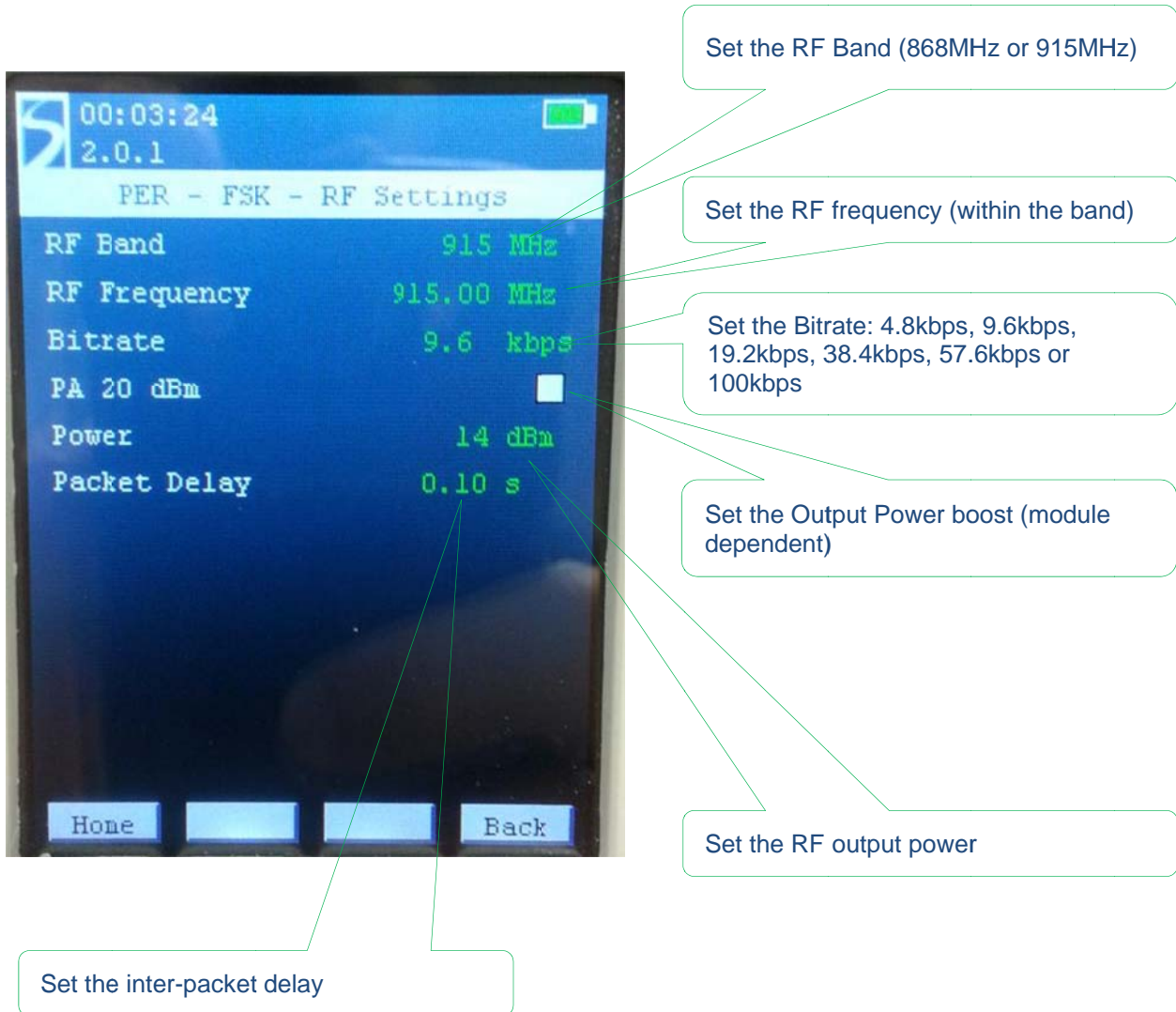

Parameter	Value	Description
RF Band	915 MHz	Set the RF Band (868MHz or 915MHz)
RF Frequency	915.00 MHz	Set the RF frequency (within the band)
Bitrate	9.6 kbps	Set the Bitrate: 4.8kbps, 9.6kbps, 19.2kbps, 38.4kbps, 57.6kbps or 100kbps
PA 20 dBm	<input type="checkbox"/>	Set the Output Power boost (module dependent)
Power	14 dBm	Set the RF output power
Packet Delay	0.10 s	Set the inter-packet delay

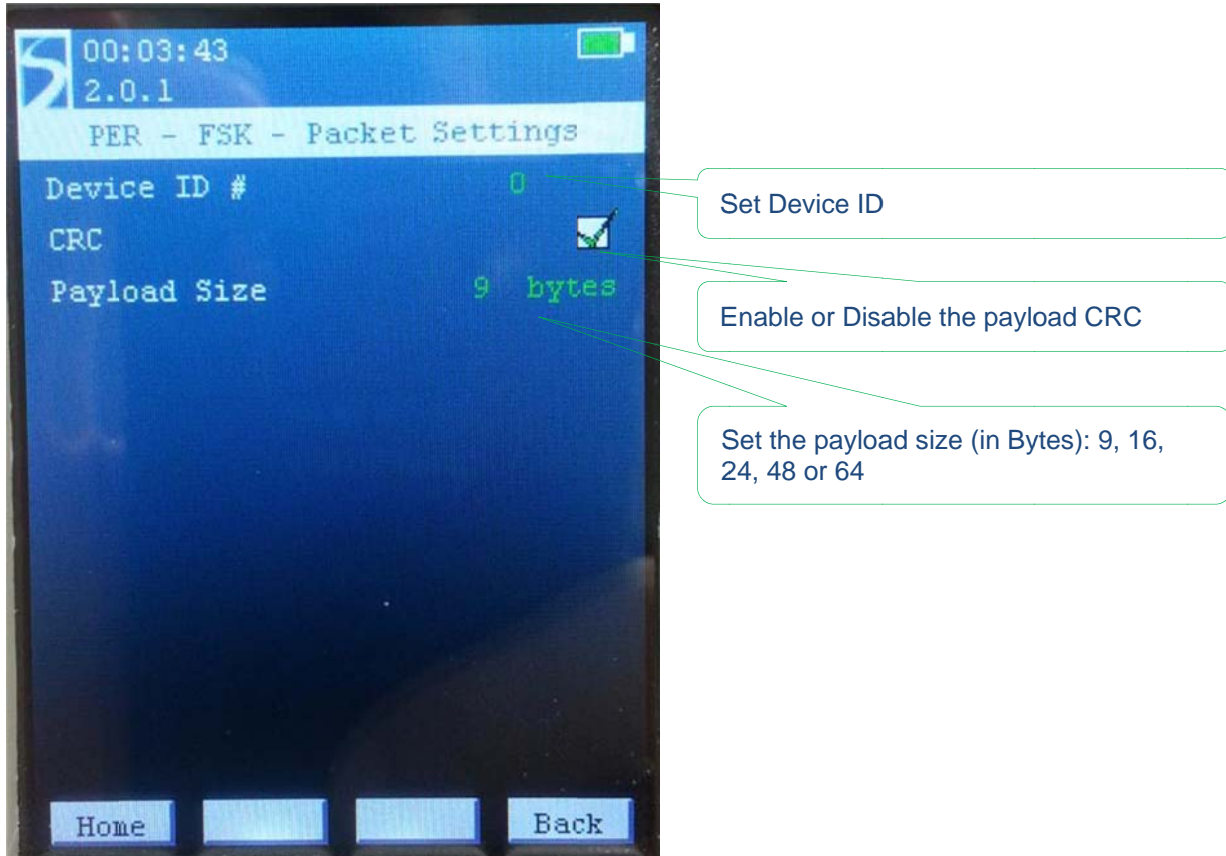
5.2.2.2 PER Packet Settings Menu running in FSK mode

In FSK mode, the payload is built in the following way:

Preamble (8 Bytes)	SyncWord (0x69-0x81-0x7E-0x96)	Payload length (1 Byte)	...	Payload (Platform ID, 32-bit packet cnt, 'P', 'E', 'R', FCS, 'Padding [xx Bytes]')	CRC (2 Bytes)
-----------------------	-----------------------------------	-------------------------------	-----	---	------------------

The preamble length, the SyncWord and the basic payload structure cannot be changed by the user. However, the payload length is adjustable and the 'Padding' field will increase or decrease depending of the payload size. The CRC can also be enabled or disabled from the packet settings menu. All in all the smallest packet will be 22 bytes long and the longest packet will be 78 bytes long in total.

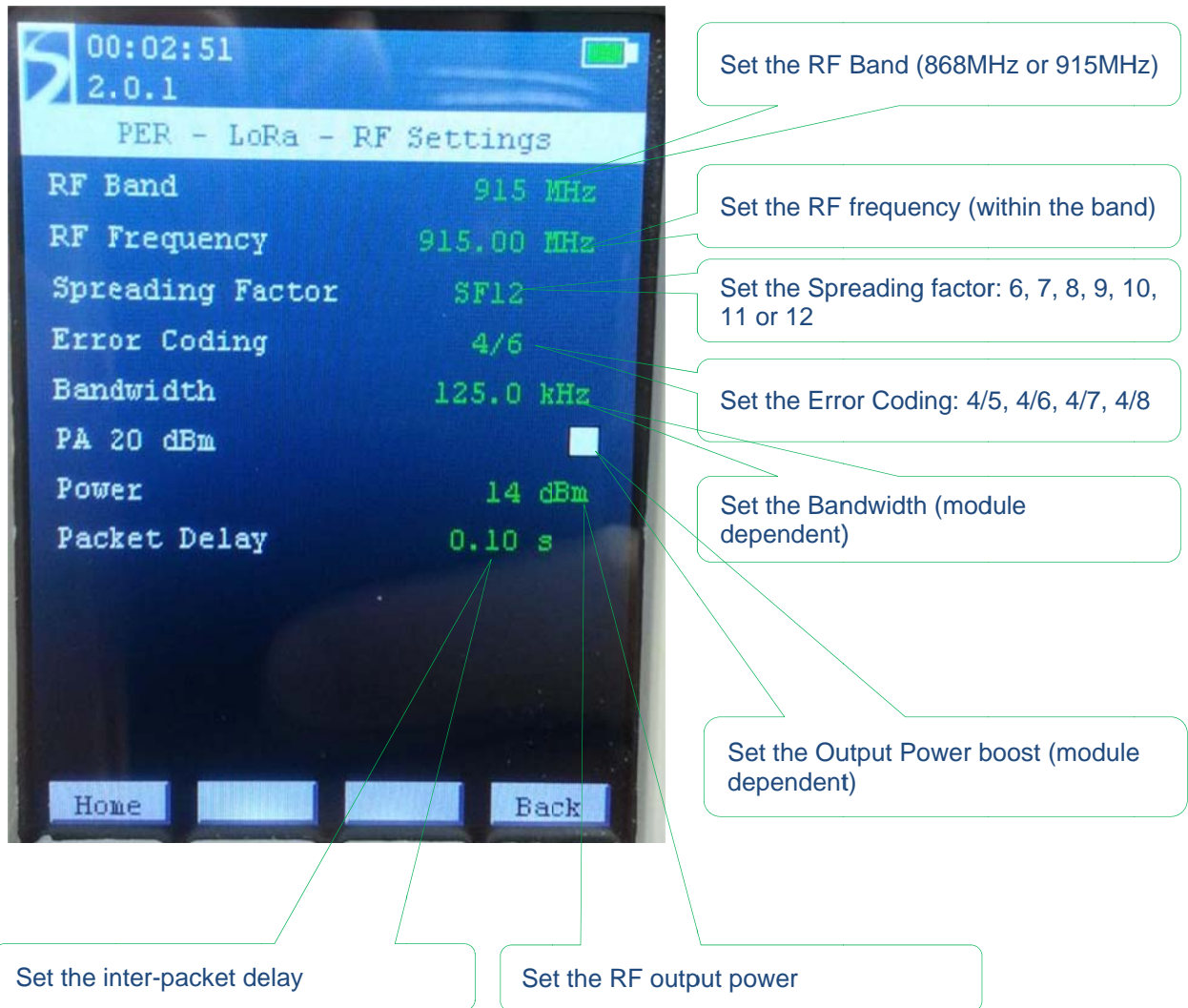
5.2.2.3 PER Settings Menu running in LoRa mode

00:02:51
2.0.1

PER - LoRa - RF Settings

RF Band	915 MHz	Set the RF Band (868MHz or 915MHz)
RF Frequency	915.00 MHz	Set the RF frequency (within the band)
Spreading Factor	SF12	Set the Spreading factor: 6, 7, 8, 9, 10, 11 or 12
Error Coding	4/6	Set the Error Coding: 4/5, 4/6, 4/7, 4/8
Bandwidth	125.0 kHz	Set the Bandwidth (module dependent)
PA 20 dBm	<input type="checkbox"/>	Set the Output Power boost (module dependent)
Power	14 dBm	Set the RF output power
Packet Delay	0.10 s	Set the inter-packet delay

Home [] [] [] Back

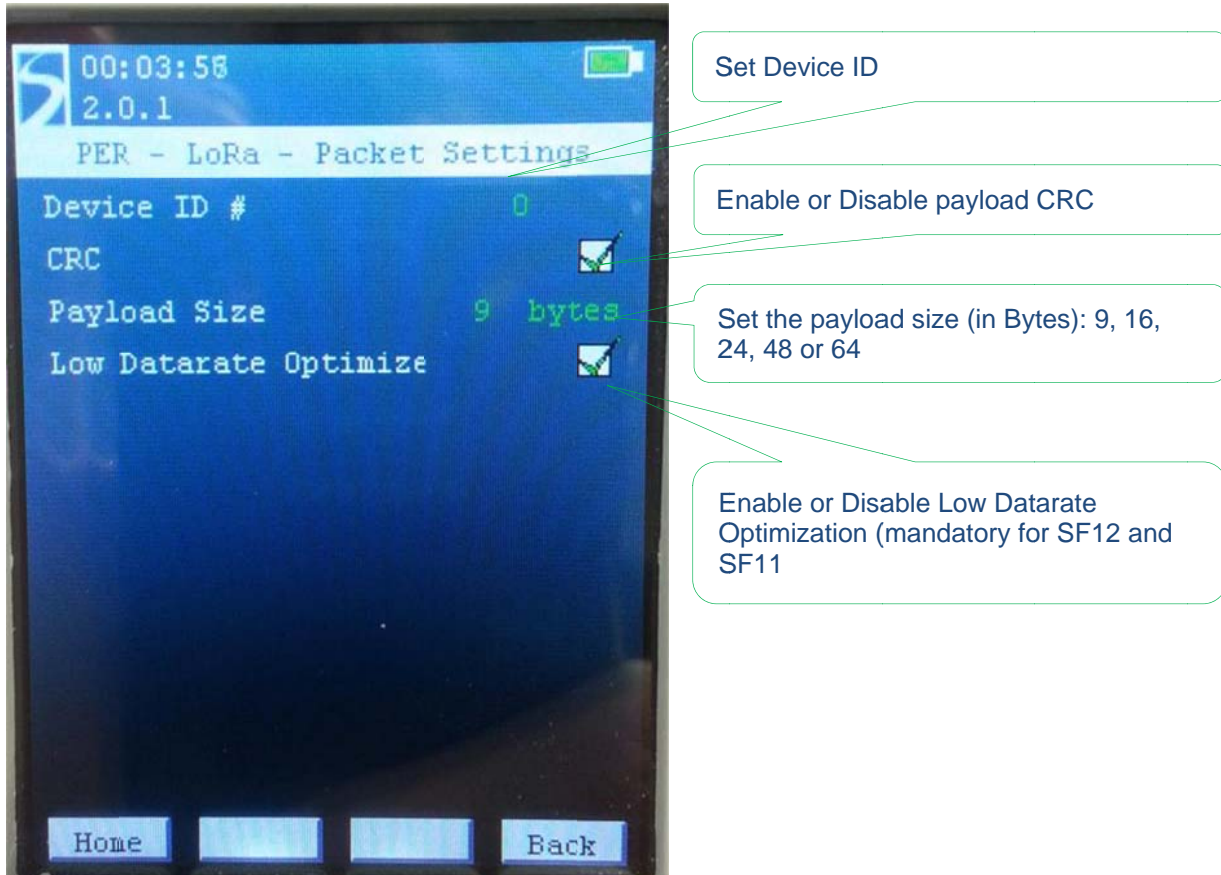
5.2.2.4 PER Packet Settings Menu running in LoRa mode

In LoRa mode, the payload is built in the following way:

Preamble (8 Symb.)	Header (8 Symb.)	Payload (Platform ID, 32-bit packet cnt, 'P', 'E', 'R', FCS, 'Padding [xx Bytes]')	CRC (2 Bytes)
-----------------------	---------------------	---	------------------

The preamble length, the Header and the basic payload structure cannot be changed by the user. However, the payload length is adjustable and the 'Padding' field will increase or decrease depending of the payload size. The CRC can also be enabled or disabled from the packet settings menu.

5.2.2.5 PER TX Mode

Once the RF parameters are set, putting the Eiger module in TX mode will initiate the packet transmission. The TX window displays the RF parameters and the number of packet sent since the beginning of the test.

PER Tx window in Lora mode:

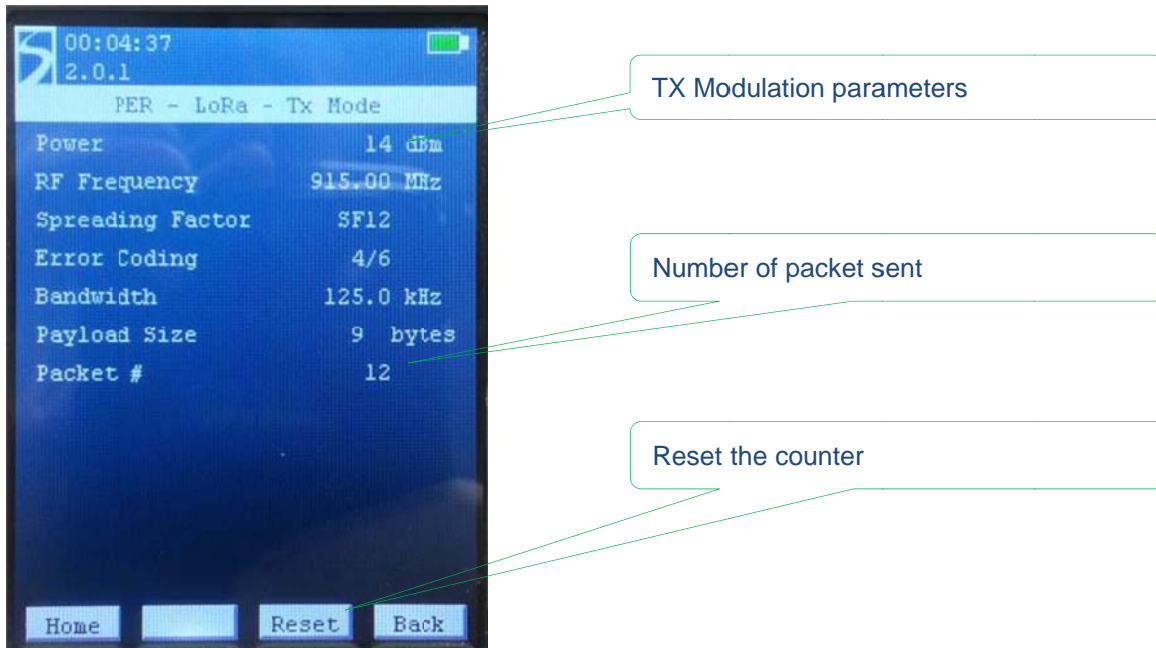

PER Tx window in FSK mode:

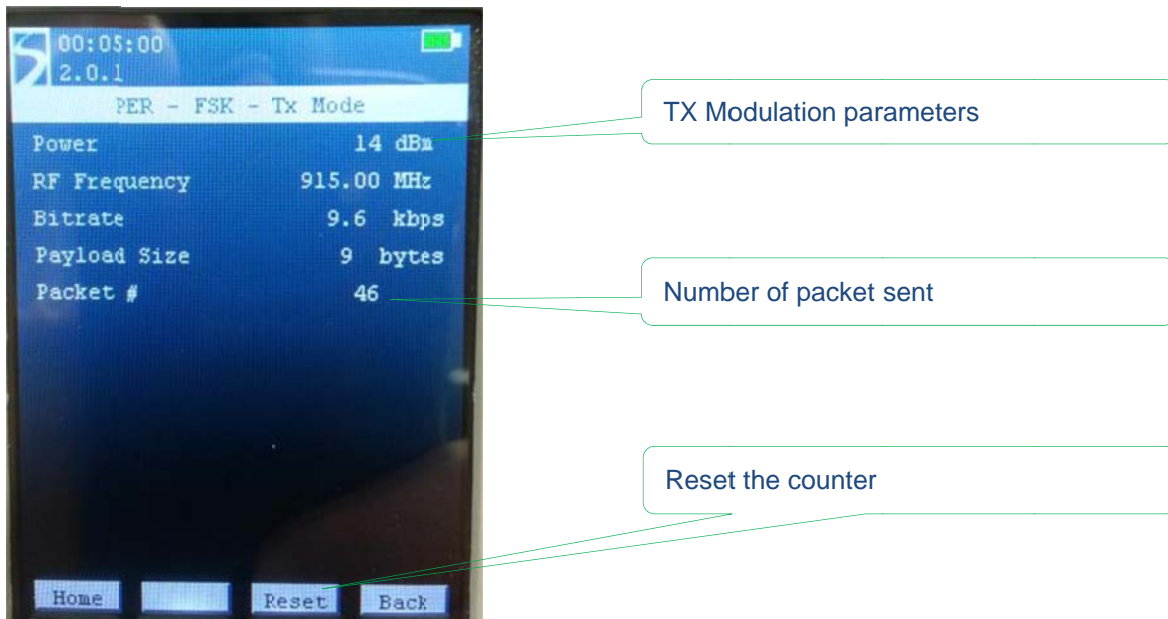

5.2.2.6 PER RX Mode

PER Rx window in Lora mode:

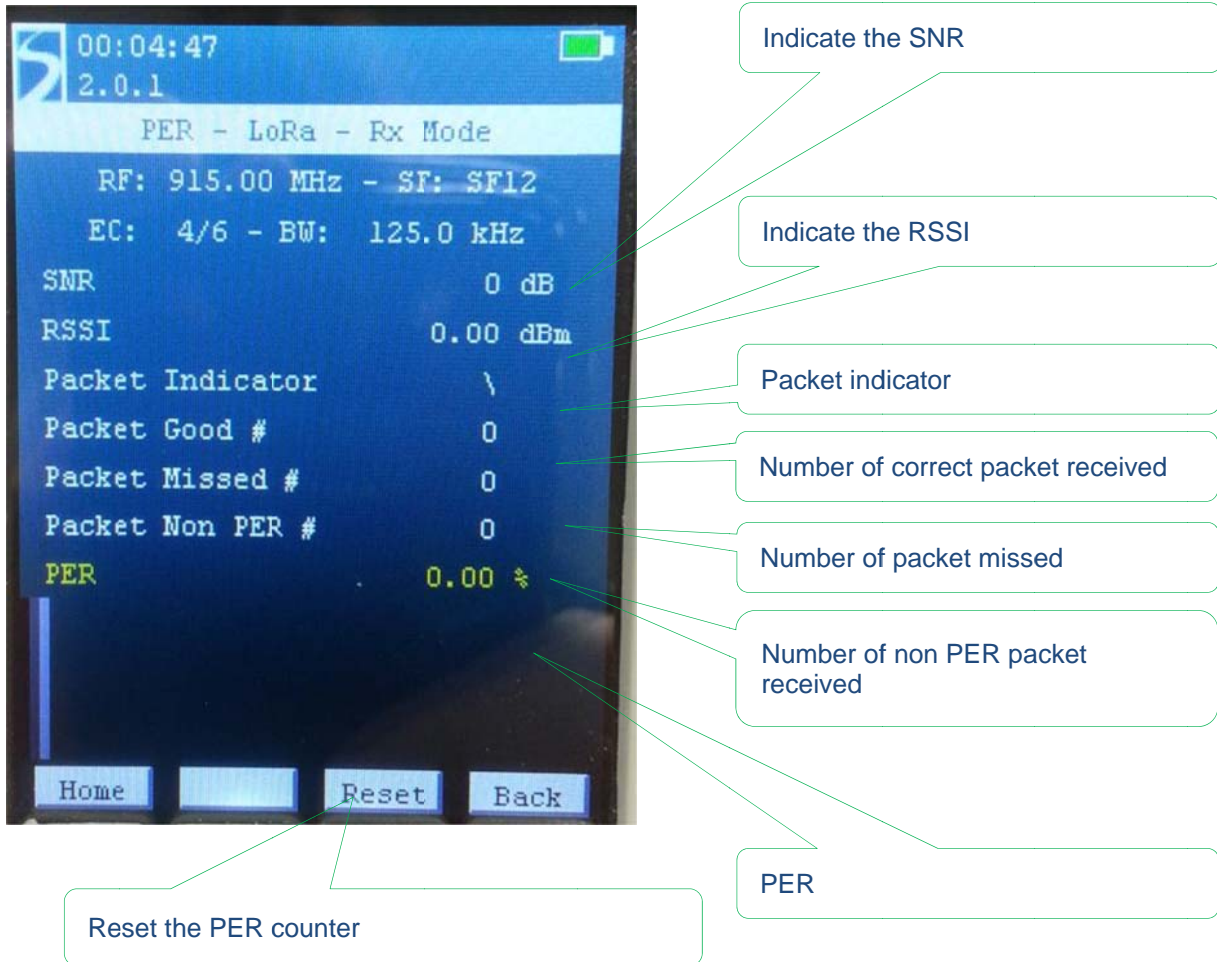

In LoRa mode, when sub-noise reception is occurring (SNR < 0), the displayed RSSI value is extrapolated using the SNR indicator. When the SNR > 0, the actual SNR is not computed and the value is clamped.

WIRELESS, SENSING & TIMING PRODUCTS

PER Rx window in FSK mode:

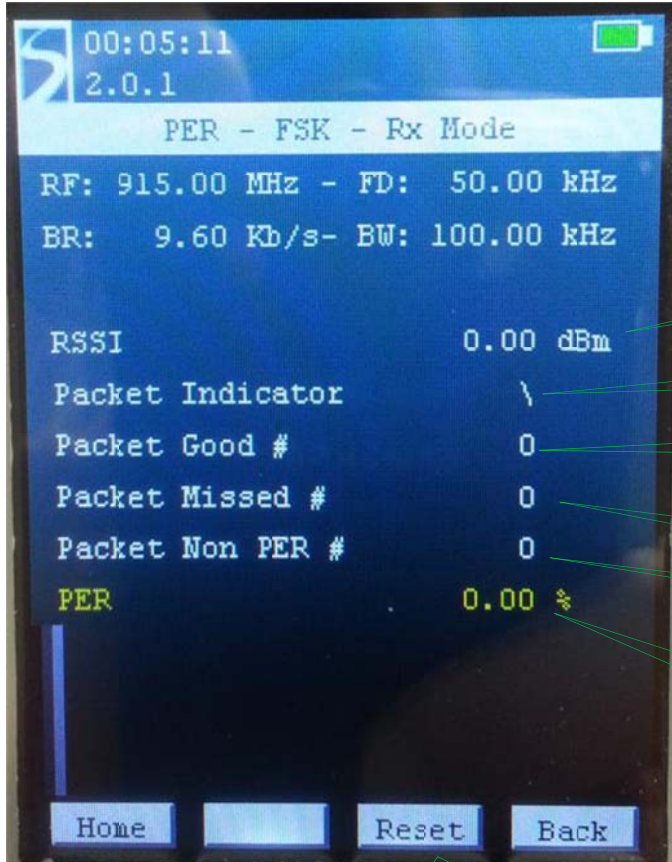

Indicate the RSSI

Packet indicator

Number of correct packet received

Number of packet missed

Number of non PER packet received

PER

Reset the PER counter

5.2.3 PER Rx Bar-graph

In Rx mode, a bar-graph indicates the distribution of the error over time. This is especially useful to detect the cause of the error, whether a burst of noise in the frequency band or if the device is in the limit of reception range. The examples below highlight what each case looks like:

Here, the device is at the limit of the reception range



Blue: the reception is good and we are receiving every packet sent

Yellow: We have some disturbance in the frequency band or we are arriving at the limit range of reception and we start missing packets.

As we can see in the picture below, the device lost many packets in a short amount of time.

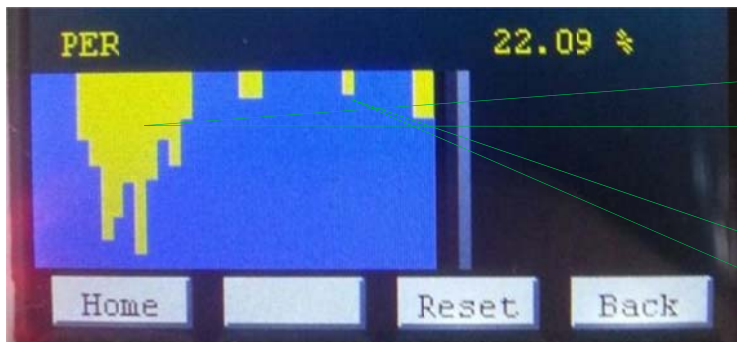

Yellow: We have had a strong burst of noise in the band and we have missed most of the packet during a small amount of time

The link has improved and we are only missing a few packets after the original noise burst.

6 SX1276SKA Software Description

The SX1276SKA is organized on a PC software GUI communicating through USB with the Eiger platforms. In this situation, the Eiger platforms are only used as a gateway to communicate with the SX1276.

6.1 SX1276SKA Quick start Guide

It is recommended that this user guide is read in conjunction with the SX1276 datasheet.

1. Plug the Eiger Platform USB ports to the computer (one USB is used to power the platform while the other USB is used for communication).
2. Run the SX1276 User Interface software: Start > All Programs > SX1276SKA > SX1276SKA
3. The SX1276SKA should connect automatically to the User Interface Software. If not, click on the USB connect button, located in the top left hand corner of the window toolbar.
4. Once connected the SX1276SKA shows the default configuration of the SX1276 register settings upon power-up. If the EVK is not connected, the GUI screen is grayed out and an error message is displayed in the bottom left hand corner of the status bar.

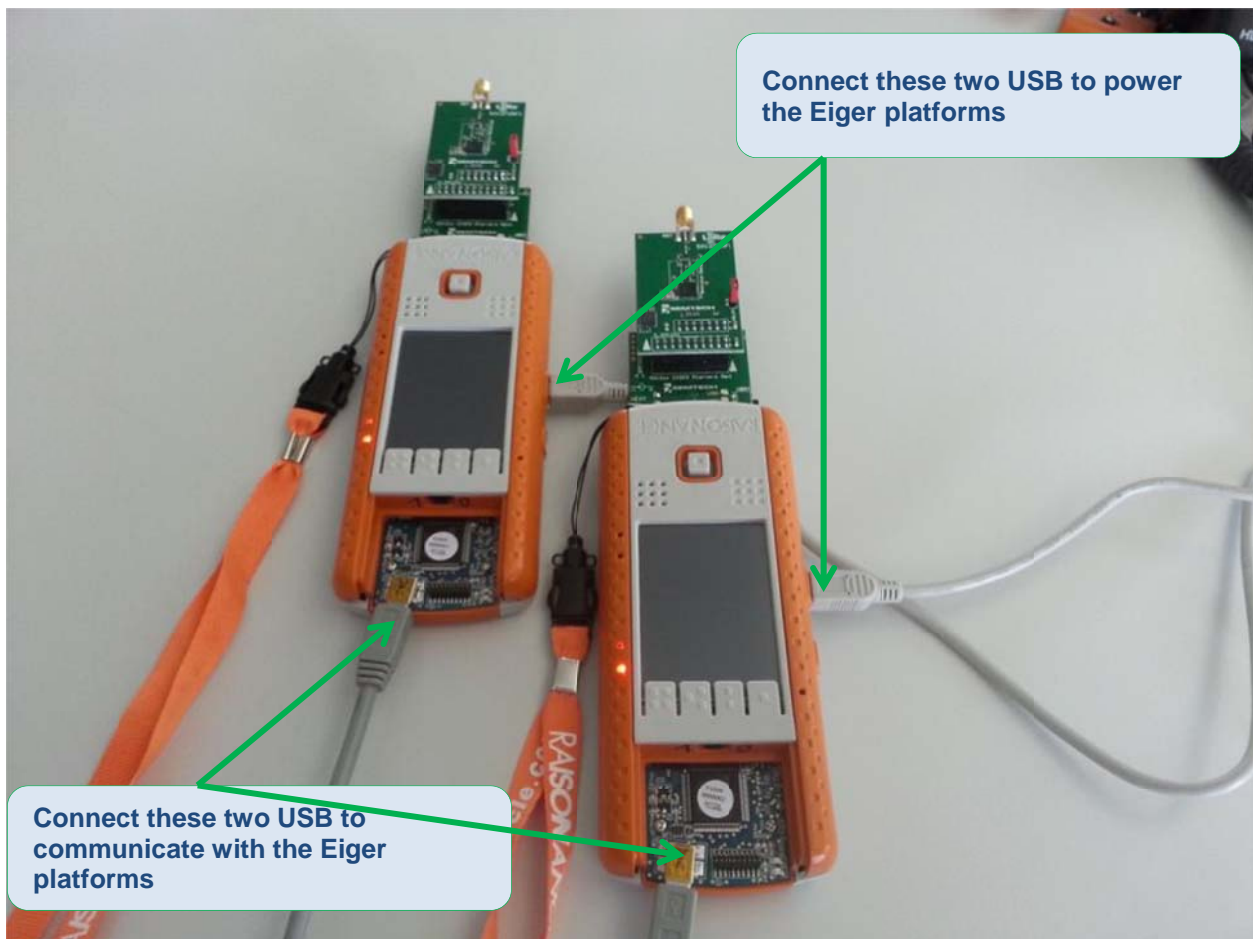

Figure 8: Connect both USB ports to use the SX1276SKA

WIRELESS, SENSING & TIMING PRODUCTS

The SX1276SKA has been developed to test all the capabilities and features of the FSK and LoRa modems present in the device. However, both modems have different control commands and must be operated independently.

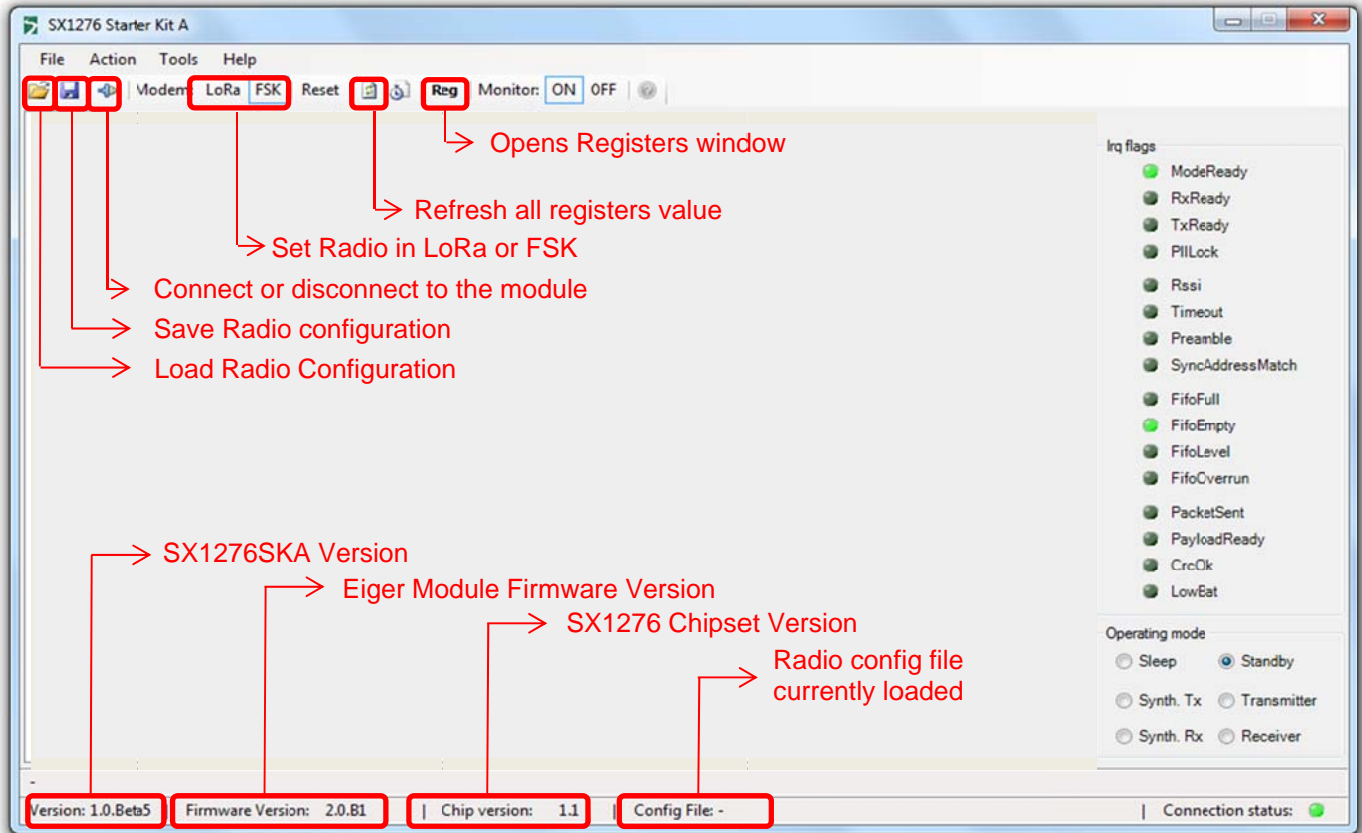

Figure 9: SX1276 window organization

While this approach has limitation on testing the system capability of the device, it allows the user to thoroughly evaluate the device from the radio point of view

This chapter is presenting the various windows and field that controls the radio operations. While some controls can be obvious, some others may need the user to refer to the datasheet to get a full description of the commands.

A load radio configuration is implemented and allows the opening of SX1276SKA configuration files (.cfg). This is implemented through a standard Windows file dialog box and may also be accessed through the short cut buttons of the Window Toolbar.

In the same way, it is possible to save the SX1276SKA configuration files (.cfg). This is implemented through a standard Windows file dialog box. The default file name is the last configuration file saved.

For reference purposes, it is possible to display the register map of the device. This can help the user to refer to the datasheet register when testing the device.

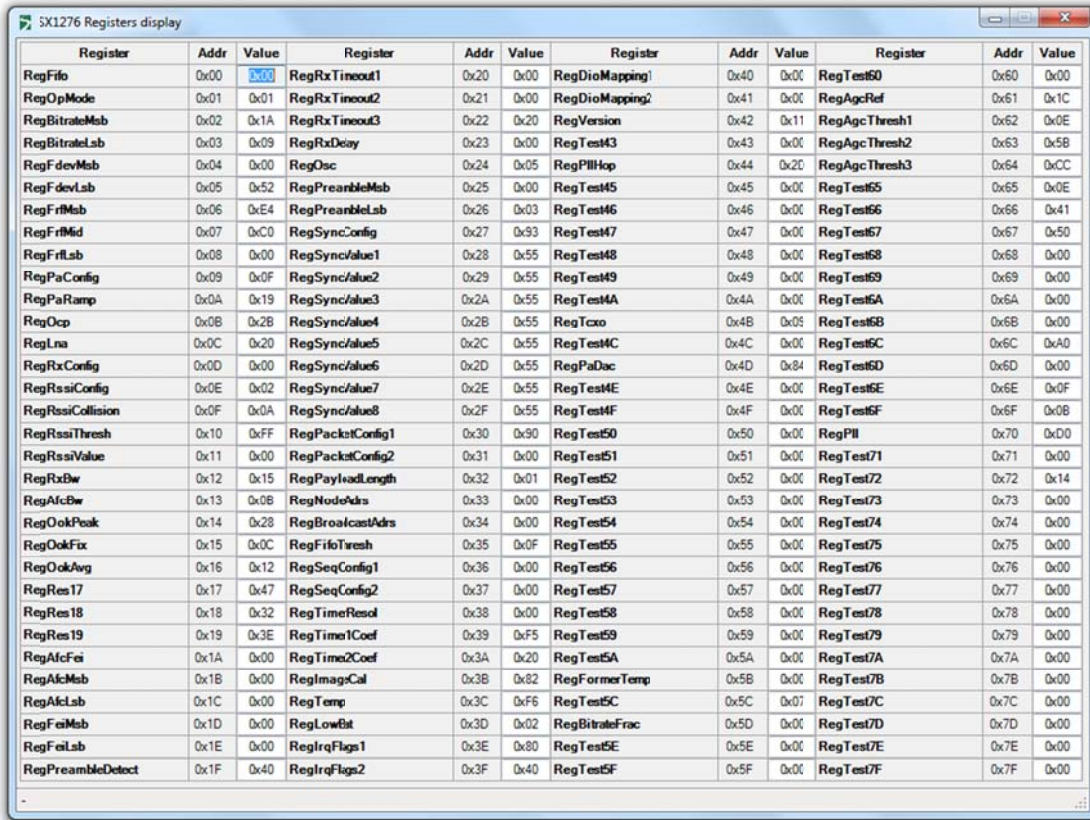

Register	Addr	Value	Register	Addr	Value	Register	Addr	Value	Register	Addr	Value
RegFifo	0x00	0x00	RegRxTimeout1	0x20	0x00	RegDioMapping1	0x40	0x00	RegTest60	0x60	0x00
RegOpMode	0x01	0x01	RegRxTimeout2	0x21	0x00	RegDioMapping2	0x41	0x00	RegAgcRef	0x61	0x1C
RegBitrateMsb	0x02	0x1A	RegRxTimeout3	0x22	0x20	RegVersion	0x42	0x11	RegAgcThresh1	0x62	0x0E
RegBitrateLsb	0x03	0x09	RegRxDelay	0x23	0x00	RegTest43	0x43	0x00	RegAgcThresh2	0x63	0x5B
RegFdevMsb	0x04	0x00	RegOsc	0x24	0x05	RegPllHop	0x44	0x20	RegAgcThresh3	0x64	0xCC
RegFdevLsb	0x05	0x52	RegPreambleMsb	0x25	0x00	RegTest45	0x45	0x00	RegTest65	0x65	0x0E
RegFrmMsb	0x06	0xE4	RegPreambleLsb	0x26	0x03	RegTest46	0x46	0x00	RegTest66	0x66	0x41
RegFrmMid	0x07	0xC0	RegSyncConfig	0x27	0x93	RegTest47	0x47	0x00	RegTest67	0x67	0x50
RegFrmLsb	0x08	0x00	RegSync/alue1	0x28	0x55	RegTest48	0x48	0x00	RegTest68	0x68	0x00
RegPaConfig	0x09	0x0F	RegSync/alue2	0x29	0x55	RegTest49	0x49	0x00	RegTest69	0x69	0x00
RegPaRamp	0x0A	0x19	RegSync/alue3	0x2A	0x55	RegTest4A	0x4A	0x00	RegTest6A	0x6A	0x00
RegOcp	0x0B	0x2B	RegSync/alue4	0x2B	0x55	RegTcxo	0x4B	0x05	RegTest6B	0x6B	0x00
RegLna	0x0C	0x20	RegSync/alue5	0x2C	0x55	RegTest4C	0x4C	0x00	RegTest6C	0x6C	0xA0
RegRxConfig	0x0D	0x00	RegSync/alue6	0x2D	0x55	RegPaDac	0x4D	0x84	RegTest6D	0x6D	0x00
RegRssiConfig	0x0E	0x02	RegSync/alue7	0x2E	0x55	RegTest4E	0x4E	0x00	RegTest6E	0x6E	0x0F
RegRssiCollision	0x0F	0x0A	RegSync/alue8	0x2F	0x55	RegTest4F	0x4F	0x00	RegTest6F	0x6F	0x0B
RegRssiThresh	0x10	0xFF	RegPacketConfig1	0x30	0x90	RegTest50	0x50	0x00	RegPll	0x70	0xD0
RegRssiValue	0x11	0x00	RegPacketConfig2	0x31	0x00	RegTest51	0x51	0x00	RegTest71	0x71	0x00
RegRxBw	0x12	0x15	RegPayloadLength	0x32	0x01	RegTest52	0x52	0x00	RegTest72	0x72	0x14
RegAfcBw	0x13	0x0B	RegNodeAdrs	0x33	0x00	RegTest53	0x53	0x00	RegTest73	0x73	0x00
RegOokPeak	0x14	0x28	RegBroadcastAdrs	0x34	0x00	RegTest54	0x54	0x00	RegTest74	0x74	0x00
RegOokFix	0x15	0x0C	RegFifoThresh	0x35	0x0F	RegTest55	0x55	0x00	RegTest75	0x75	0x00
RegOokAvg	0x16	0x12	RegSeqConfig1	0x36	0x00	RegTest56	0x56	0x00	RegTest76	0x76	0x00
RegRes17	0x17	0x47	RegSeqConfig2	0x37	0x00	RegTest57	0x57	0x00	RegTest77	0x77	0x00
RegRes18	0x18	0x32	RegTimeResol	0x38	0x00	RegTest58	0x58	0x00	RegTest78	0x78	0x00
RegRes19	0x19	0x3E	RegTime1Coef	0x39	0xF5	RegTest59	0x59	0x00	RegTest79	0x79	0x00
RegAfcFei	0x1A	0x00	RegTime2Coef	0x3A	0x20	RegTest5A	0x5A	0x00	RegTest7A	0x7A	0x00
RegAfcMsb	0x1B	0x00	RegImagCal	0x3B	0x82	RegFormerTemp	0x5B	0x00	RegTest7B	0x7B	0x00
RegAfcLsb	0x1C	0x00	RegTemp	0x3C	0xF6	RegTest5C	0x5C	0x07	RegTest7C	0x7C	0x00
RegFaiMsb	0x1D	0x00	RegLowBat	0x3D	0x02	RegBitrateFrac	0x5D	0x00	RegTest7D	0x7D	0x00
RegFaiLsb	0x1E	0x00	RegIrfFlags1	0x3E	0x80	RegTest5E	0x5E	0x00	RegTest7E	0x7E	0x00
RegPreambleDetect	0x1F	0x40	RegIrfFlags2	0x3F	0x40	RegTest5F	0x5F	0x00	RegTest7F	0x7F	0x00

Figure 10: Register table

For advance user only, it is also possible to read or write the register directly by pressing the <CTRL>+<ALT>+<T> keys of the PC keyboard simultaneously.

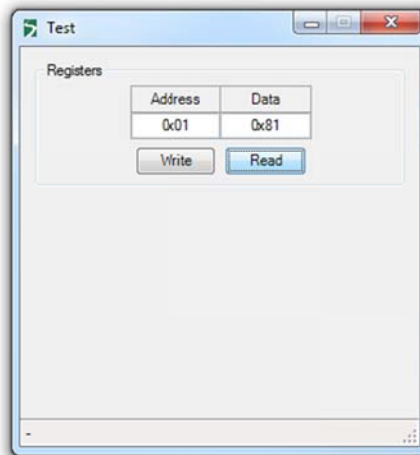

This window allows the user to write to and read from the contents of individual configuration register addresses. Note that address and data are entered in hexadecimal format.

6.2 LoRa Mode

6.2.1 LoRa Menu

By default, when the application is launched, the SX1276SKA is configured in LoRa.

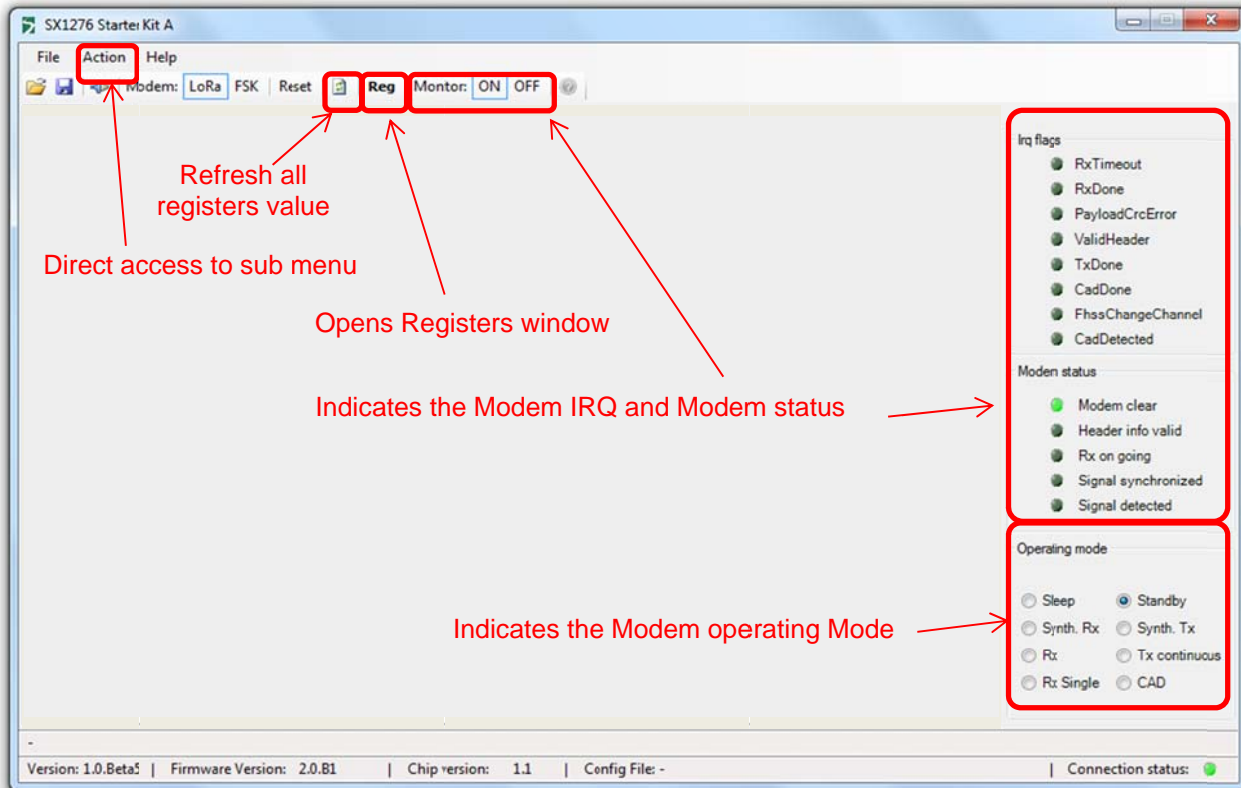

6.2.2 LoRa Common Window

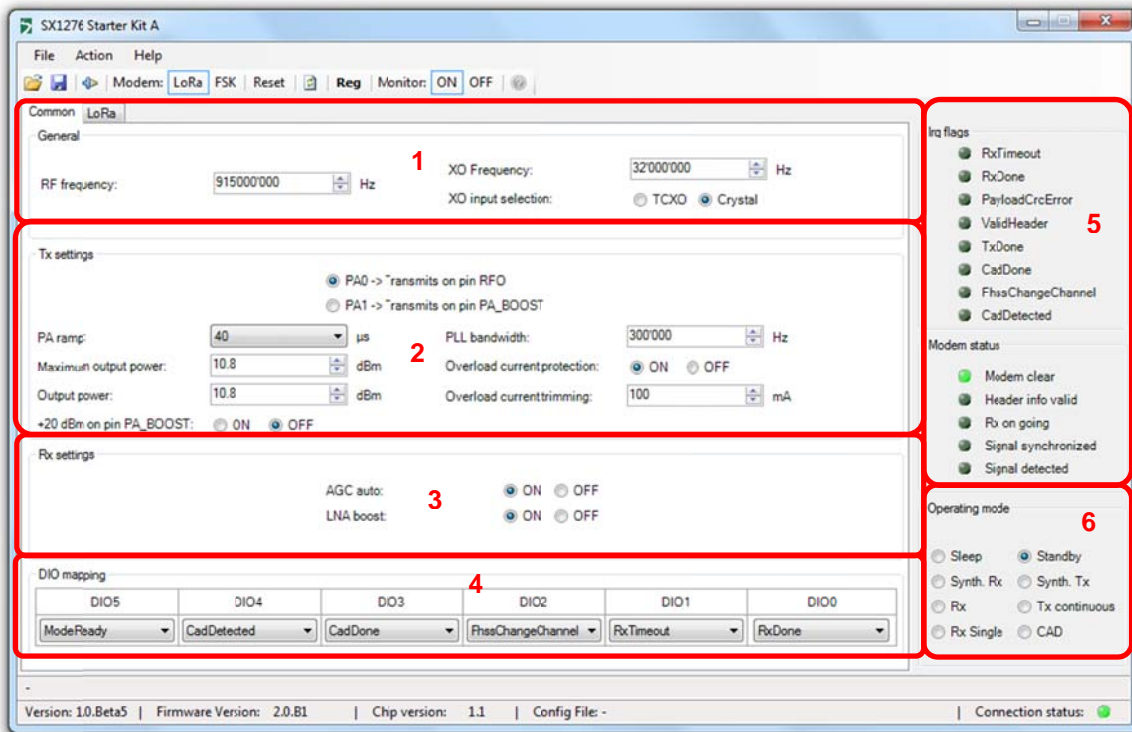

Figure 11: SX1276SKA Boot-up windows

- 1: Set the default basic parameters for the Radio.
- 2: Set the parameters related to the transmission of the data such as output power.
- 3: Set the parameters related to the reception of the data such as AGC or LNA boost settings.
- 4: Set the mapping for the device IO pins. The Status of the IO is then displayed over time in the section 5 of the window.
- 5: This section indicates the modem and DIOs status
- 6: Set the operating mode of the device.

6.2.3 LoRa Parameters Window

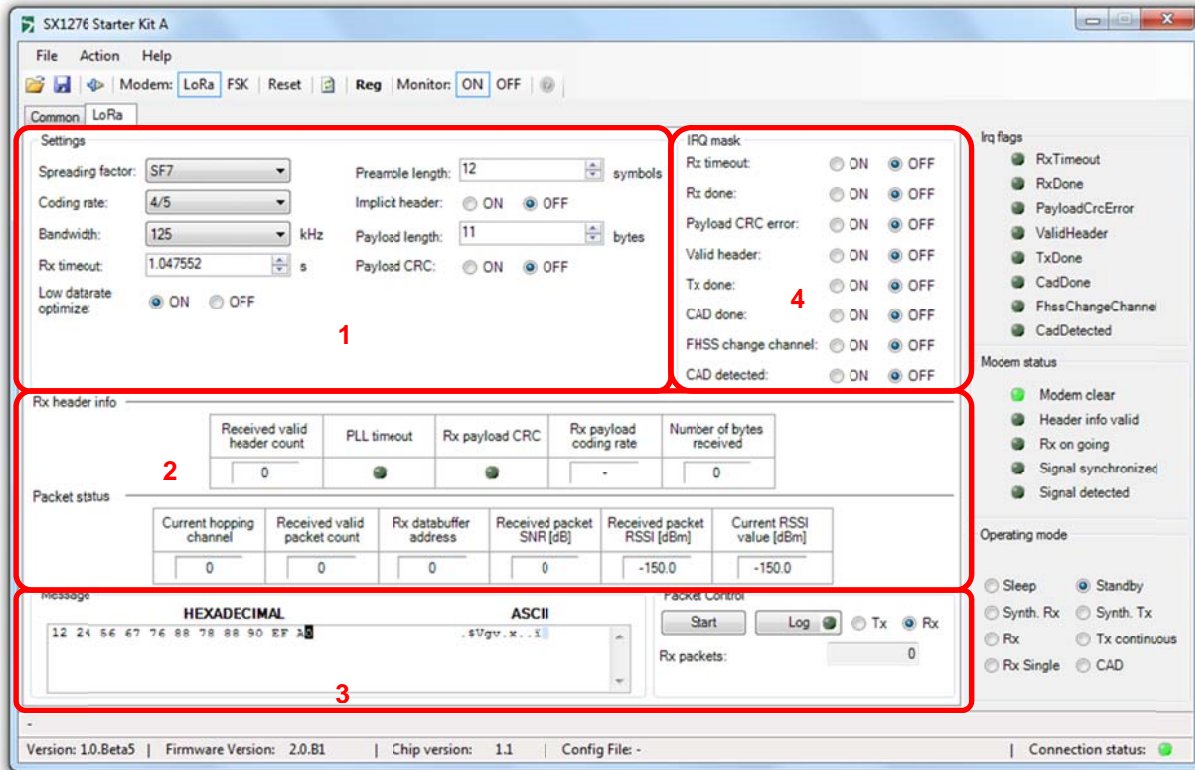

Figure 12: LoRa Radio parameters window

- 1: Set the Radio settings for the LoRa modulation
- 2: Details status of the reception
- 3: Set the payload to be transmitted control the emission or reception of the radio
- 4: Enable or disable the IRQ related to the LoRa modulation

6.3 FSK Mode

6.3.1 FSK Menu

The FSK menu is organized around several windows allowing the user to set the radio step by step. The detail of each window is described from section 5.2.1.1 onward.

Some information are however global to the FSK radio operation and are thus displayed on every window as shown on figure 9.

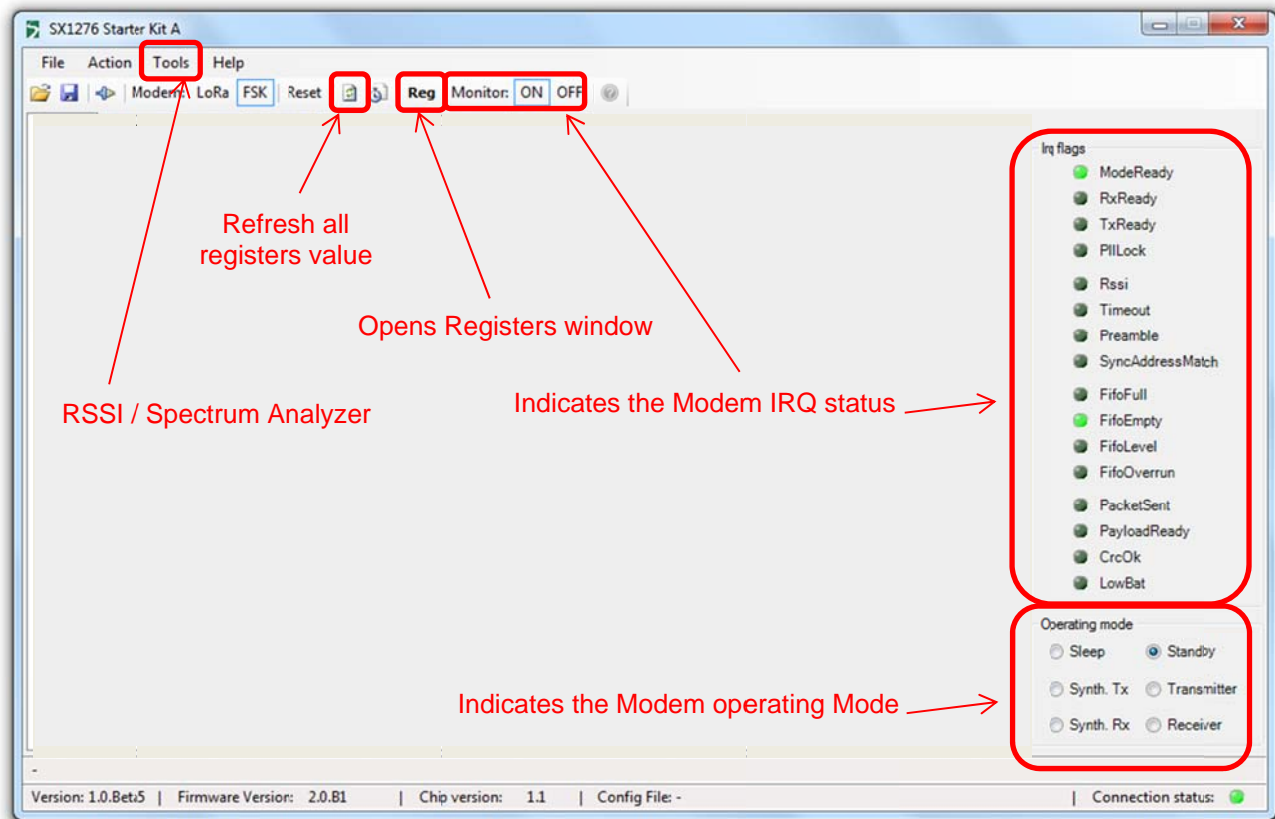

Figure 13: FSK window structure

In FSK mode, it is possible to perform a quantitative spectrum analysis but reading the RSSI value across a range of Frequency. It is also possible to have a qualitative measurement of the RSSI as it is detected by the chipsets. This tool is especially useful when a more expensive spectrum analyzer is not at hand reach.

When Monitor is set to ON, the GUI will constantly scan the status of the FSK IRQ register and displays the status on the right hand side of the GUI. Setting Monitor to OFF disables this features.

6.3.2 Common window

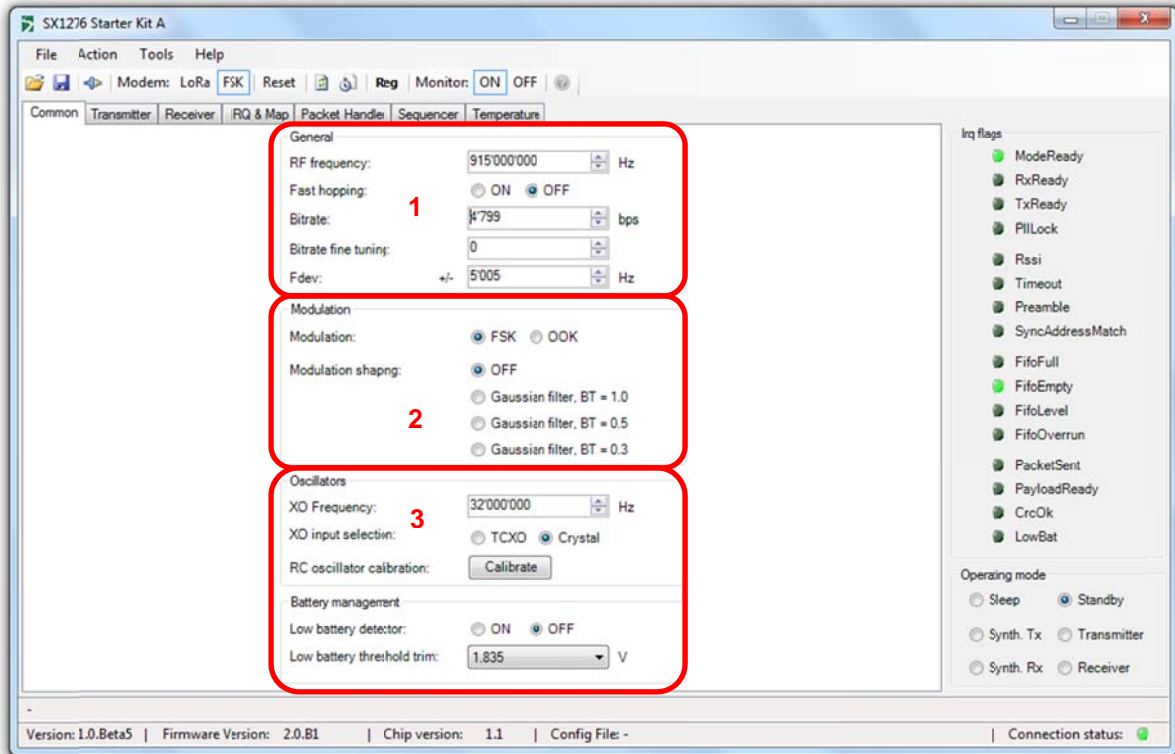

Figure 14: FSK Common window

The Common window allows the user to set the common Tx/Rx parameters for the modulation. Parameters such as the modulation type (FSK or OOK), Frequency, Bitrate, frequency deviation or the oscillator details can be entered in this window.

When Frequency Hopping is used, the control bit “Fast Hoping” need to be set so that the internal PLL can optimize to jump from one frequency to the next in the smallest amount of time.

It is also in this window that the Gaussian Filter parameter is set for the transmission. A general description would be:

- 1: Set the general parameters for the modulation
- 2: Set the modulation Type and the Gaussian filter parameter (Tx Only)
- 3: Set the oscillators parameters

6.3.3 Transmitter window

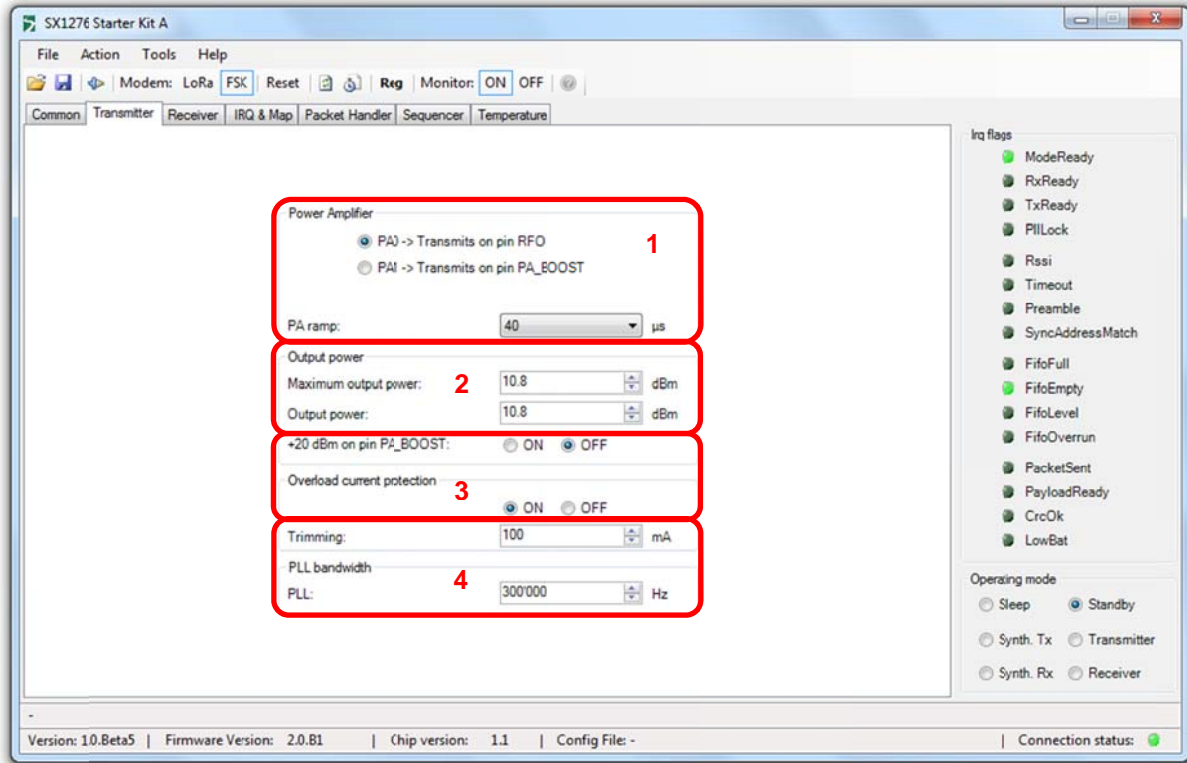

Figure 15: FSK Transmitter window

As indicated through its name, the transmitter window groups the configuration parameters related to the transmission:

- 1: This field allows the user to select the radio output pin. Depending of the SX1276 module version, it may or may not be possible to select the RFO pin as output.
- 2: Set the output power of the radio. The maximum output power is 20dBm.
- 3: Overload current protection
- 4: PLL Bandwidth

6.3.4 Receiver window

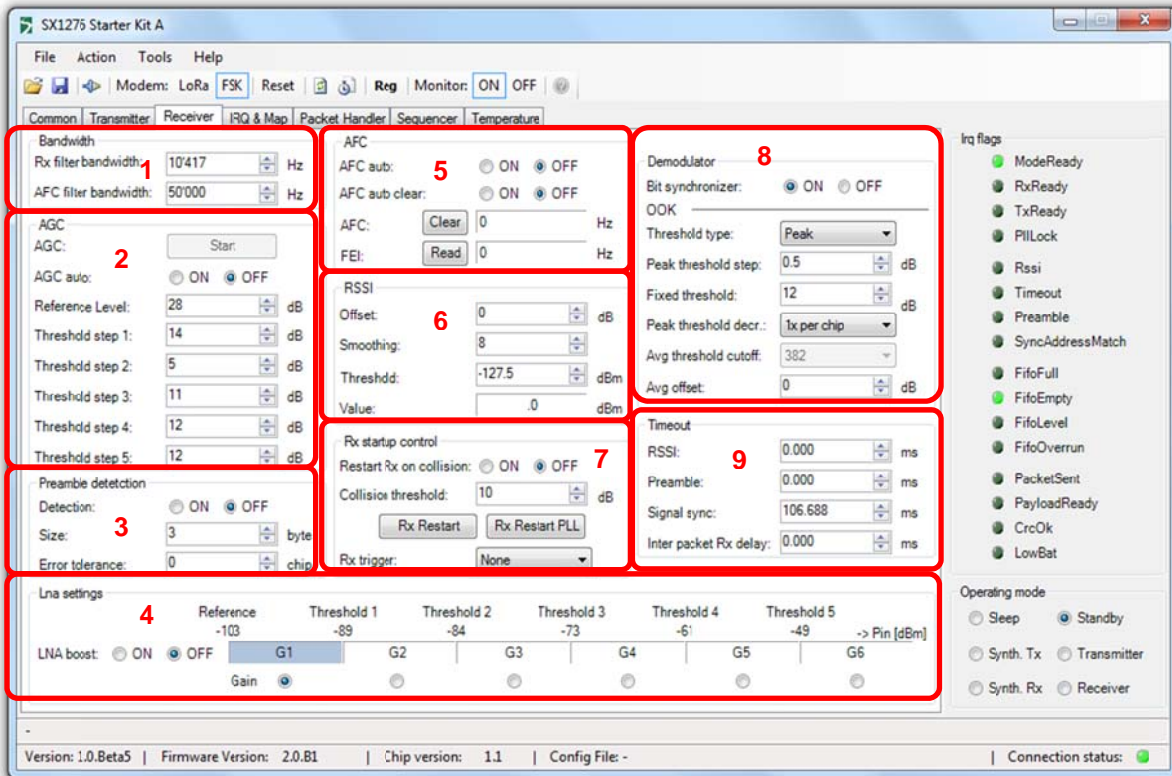

Figure 16: FSK Receiver window

This window allows the user to set the parameters for the packet reception:

- 1: Set the reception bandwidth filter and set the AFC reception bandwidth filter. Please, note that the AFC bandwidth filter is disregarded if AFC Auto is set to OFF.
- 2: Enable or disable the AGC and set the step threshold (I am not sure what it does actually).
- 3: Enable or disable the preamble detector and set the preamble detector parameters. Please, note that the preamble detector must be enabled if the reception is triggered on preamble detection.
- 4: Enable or disable the LNA boost.
- 5: Enable or disable the AFC and read the FEI.
- 6: Control the RSSI detection. If the reception is triggered on the RSSI detection, these parameters allow controlling the level of RSSI triggering the reception and smoothing the peak detector to avoid false detection in case of random peak in the frequency band.
- 7: These parameters control the events that trigger a reception and the behavior of the receiver in case of collision.
- 8: Enable or Disable the bit synchronizer and configure the OOK demodulator.
- 9: Set internal timing between events.

6.3.5 IRQ and Map window

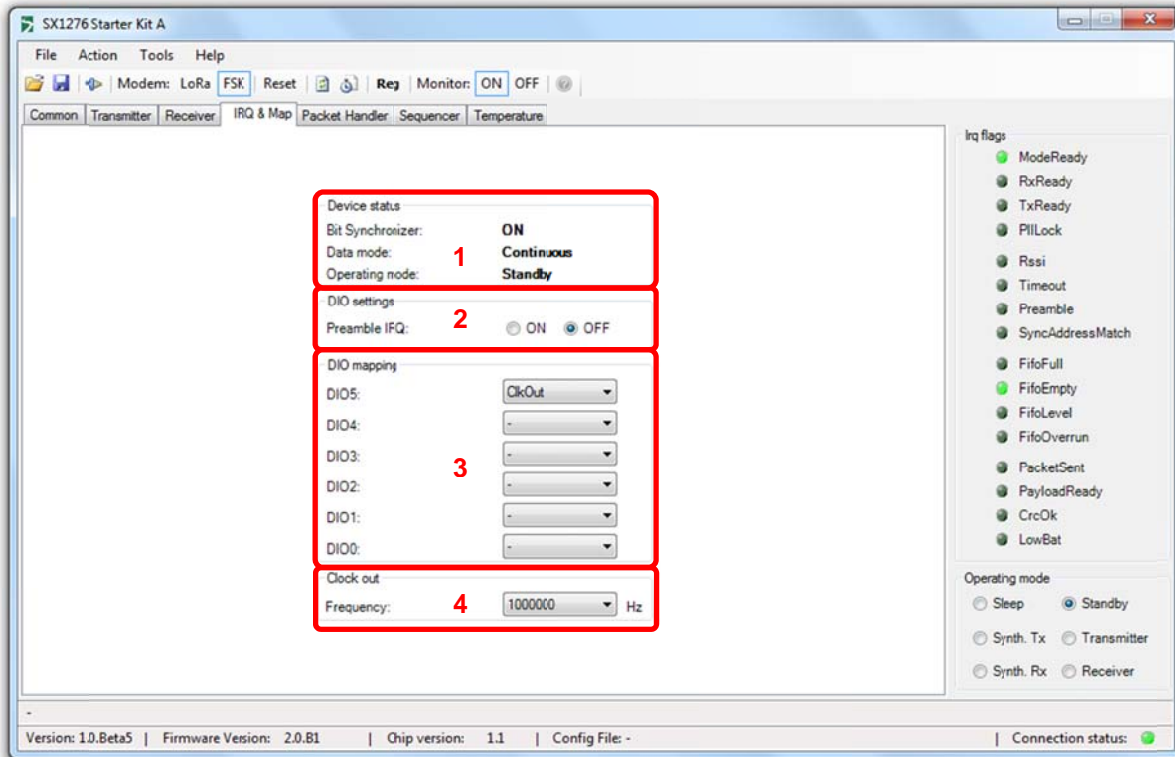

Figure 17: FSK IRQ and Map window

The IRQ and Mapping window is used to set and control the IRQs in the device:

- 1: Indicates the current status of the device
- 2: Enable or disable the preamble detection IRQ (when starting on RSSI detection)
- 3: Configures the IRQ and how they are mapped with the DIOs of the device.
- 4: Disable or Enable and set the clock out of the device

6.3.6 Packet Handler window

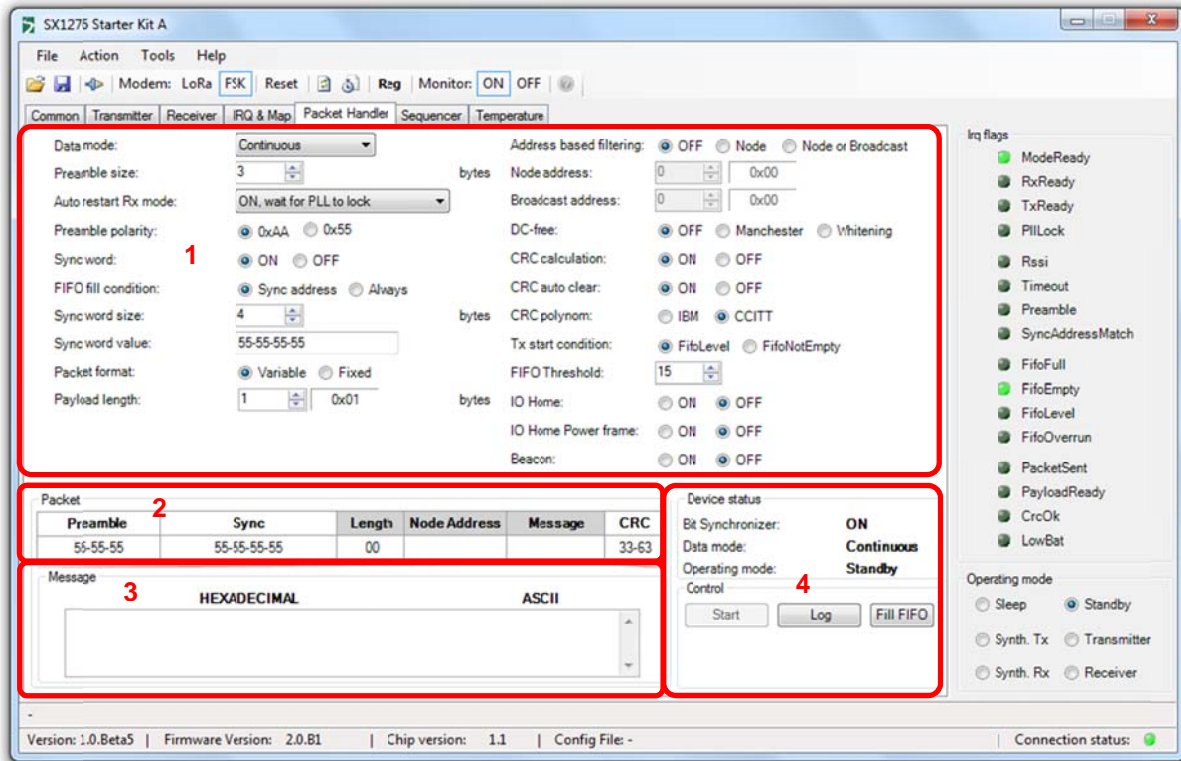

Figure 18: FSK Packet Handler window

The packet handler is the main interface windows to control the transmission or reception of packets once the radio has been setup. Whether in transmission or reception, this window allow the user to defined the packet to be transmitted or to be received

- 1: This field allows the user to define the packet structure.
- 2: Once the packet structure has been defined, this view allows the user that all each field of the packet structure is set correctly.
- 3: Enter the payload to be transmitted or display the payload received.
- 4: Control the packet handler transmission or reception.

6.3.7 Sequencer window

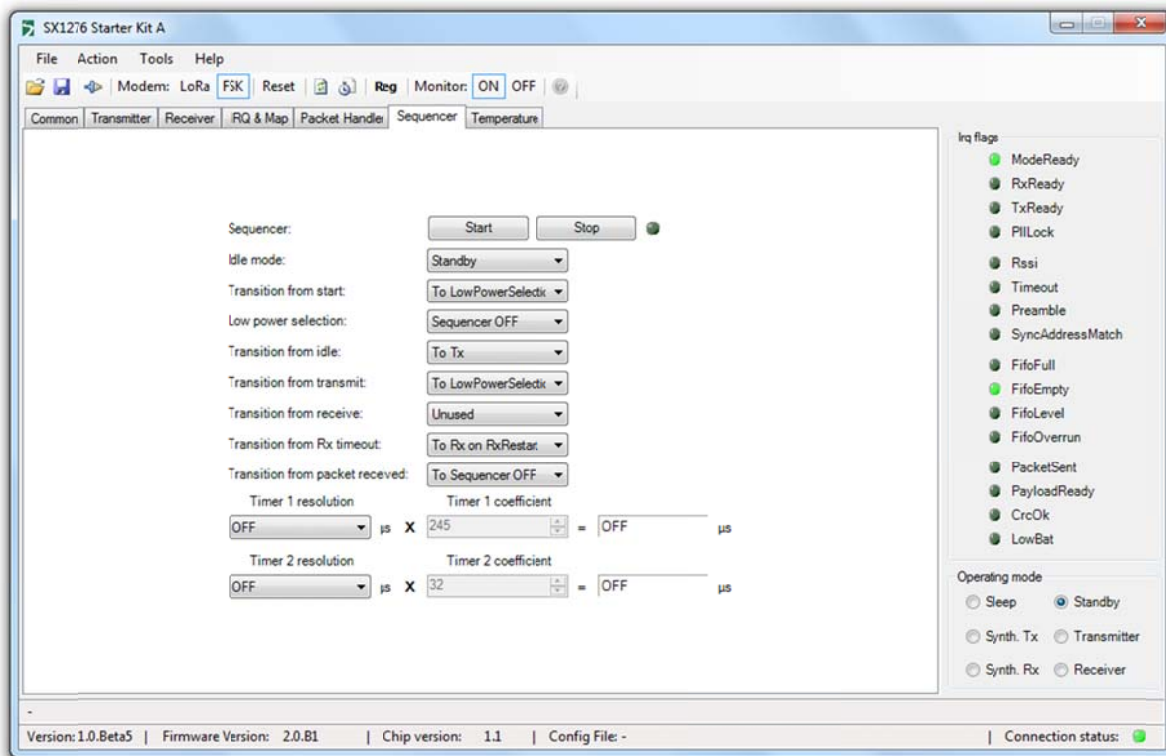

Figure 19: FSK Sequencer window

The sequencer window allows the user to setup the internal state machine of the device and control how the device will react following an event. For more information on the FSK internal state machine, please, refer to the datasheet.

6.3.8 Temperature window

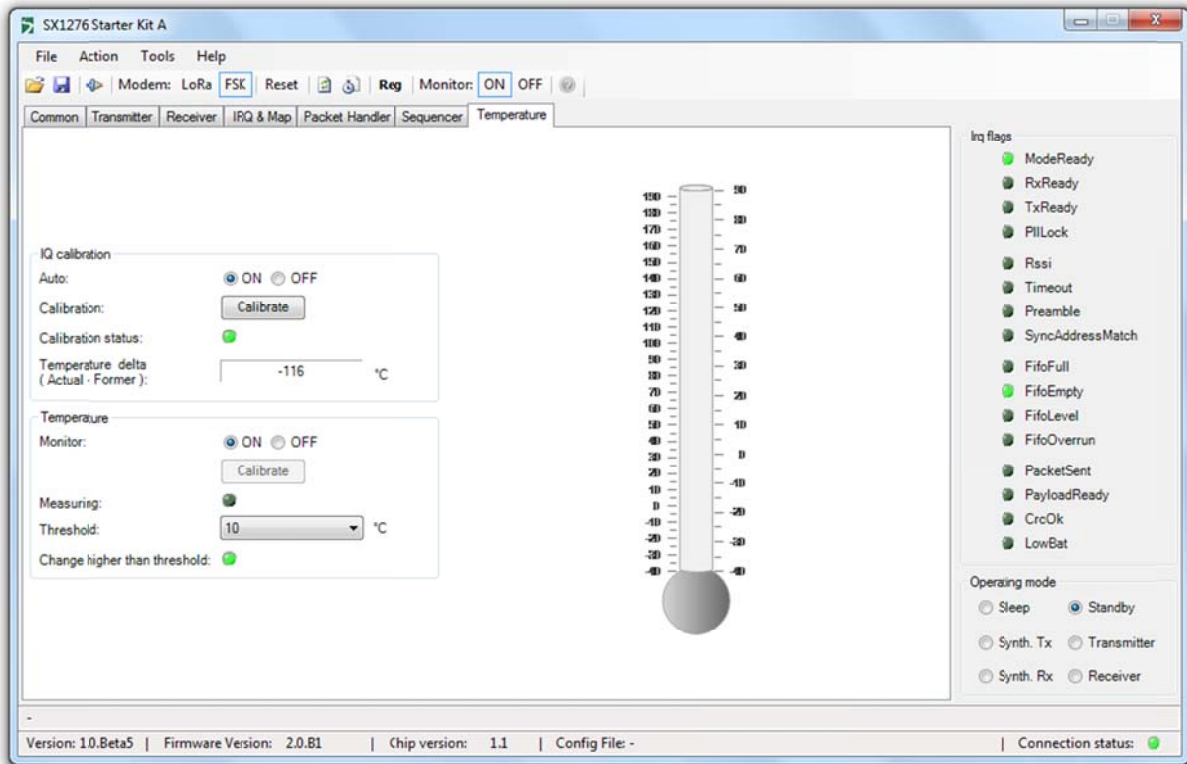

Figure 20: FSK Temperature window

The SX1276 is fitted with an internal temperature sensor. Note that user is prompted to calibrate the SX1276 temperature sensor by clicking on the Calibrate button to access the temperature calibration dialog box. If auto calibration is set, a new calibration will be performed at every temperature change that exceeds the threshold. Threshold value could be set to 5, 10, 15 and 20°C.

7 How to...

7.1 ... perform a simple transmission / reception in LoRa

Performing a simple Transmission – Reception in LoRa is fairly straight forward. First, the user needs to set the RF transmission parameters:

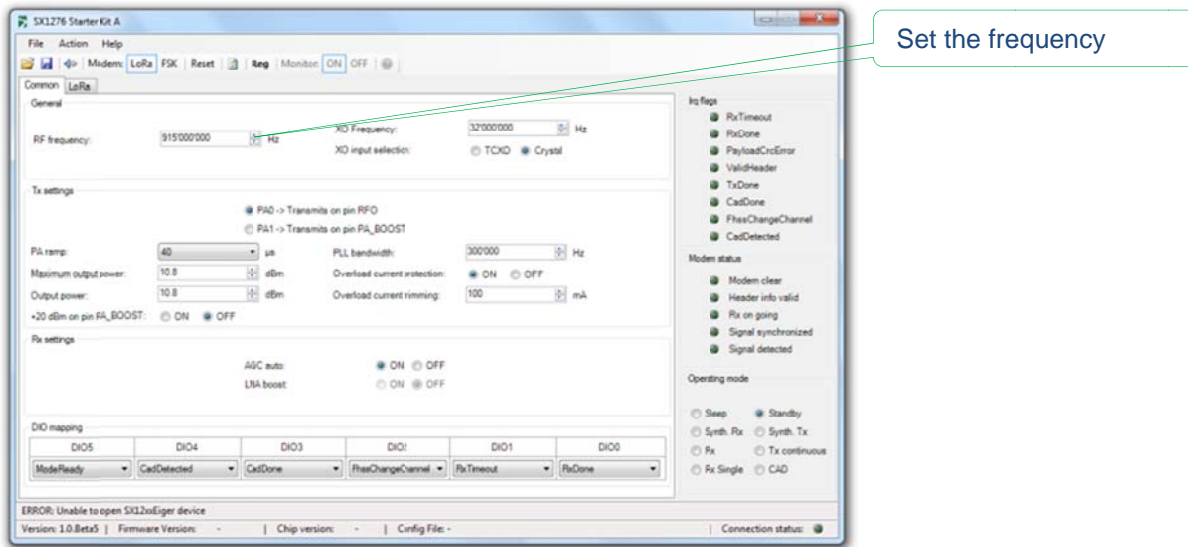

Second, the user needs to set the LoRa modulation parameters:

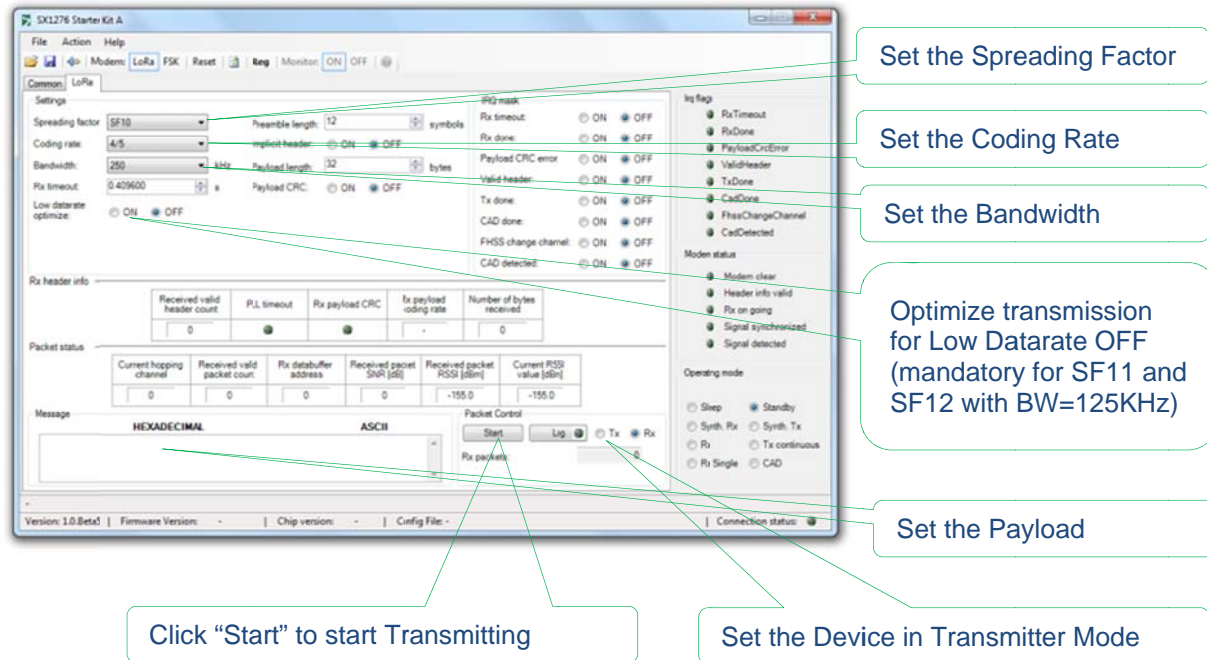

It is important to notice that the device mode of operation is standby between packets, this is why the Operating mode is left in "Standby".

On the Reception side, the principle is exactly the same. We first need to set the basic radio parameters:

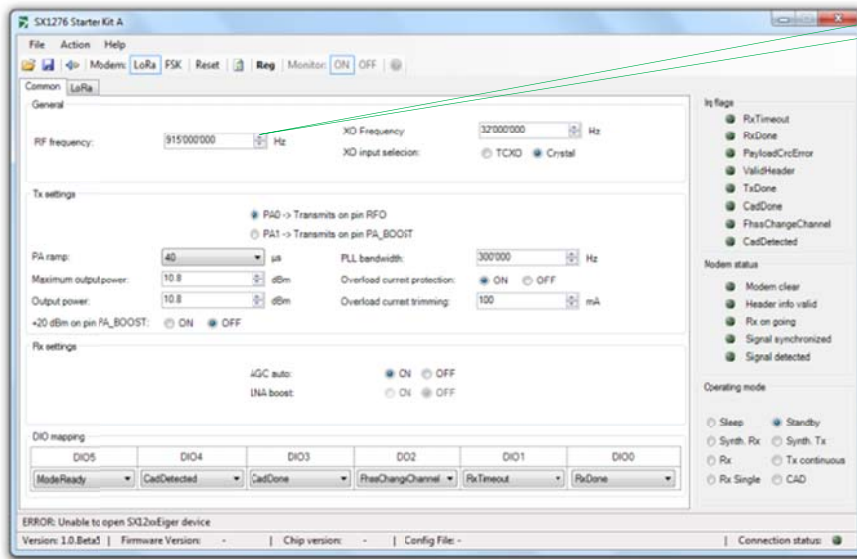

Set the frequency

Then we need to set the device in reception after setting the Lora modulation parameters.

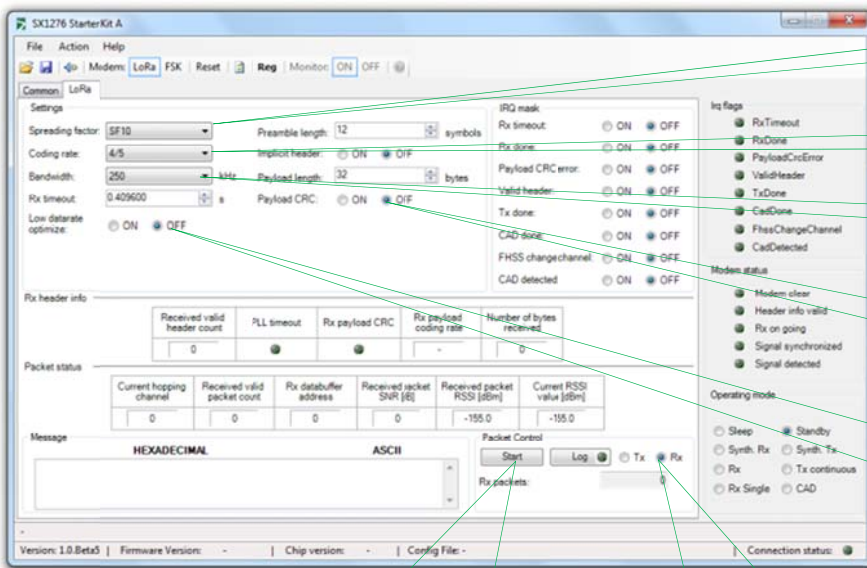

Set the Spreading Factor

Set the Coding Rate

Set the Bandwidth

Enable the payload CRC check

Optimize transmission for Low datarate OFF (mandatory for SF11 and SF12)

Click "Start" to start Receiving

Set the Device in Receiver

At this stage, the transmission – reception should be complete and the user should see the LEDs blinking on the Eiger platforms.

7.2 ... perform a simple transmission / reception in FSK

First, you need to set the RF parameters for the transmission:

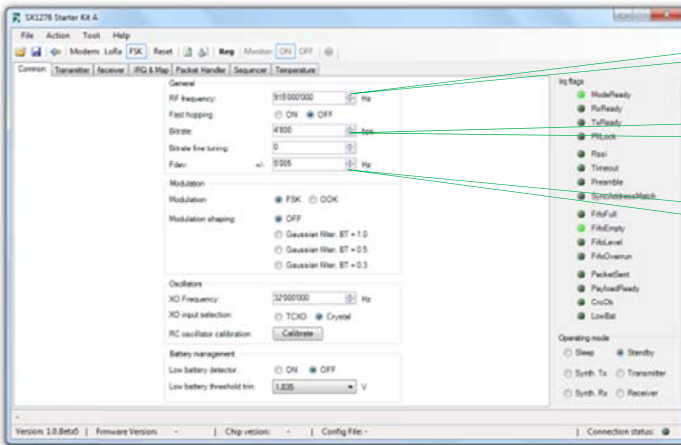

Set the frequency: 915,000,000 Hz

Set the bitrate: 19,200 bps

Set the Frequency deviation: 50,000 Hz

In the transmitter, receiver and IRQ windows, all the parameters can be left at their default values and then we simply need to set our packet structure.

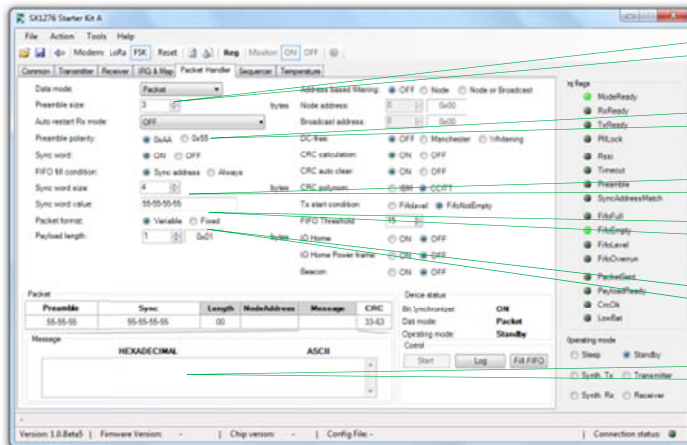

Set the preamble size: 5

Set the preamble polarity: 0x55

Set the Sync Word size: 4

Set the Sync Word: 0x69- 0x81-...

Set the packet length: variable

Set the payload: 0xA1-0xA2-...

WIRELESS, SENSING & TIMING PRODUCTS

At this stage the radio is fully configured on the transmitter side. We can now set the device in Transmitter mode so that packets are ready to be sent from the device.

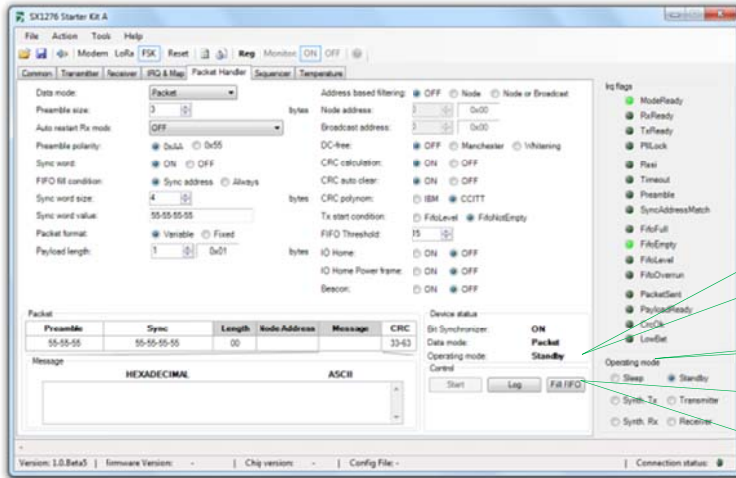

Tx Packets: Indicates the number of packets sent

Set the Device in Transmitter Mode

A small control window appears allowing the user to set the number of packets to be sent. Setting the value to '0' will make the device transmitting indefinitely.

To start sending packets, simply click on the “Start” button.

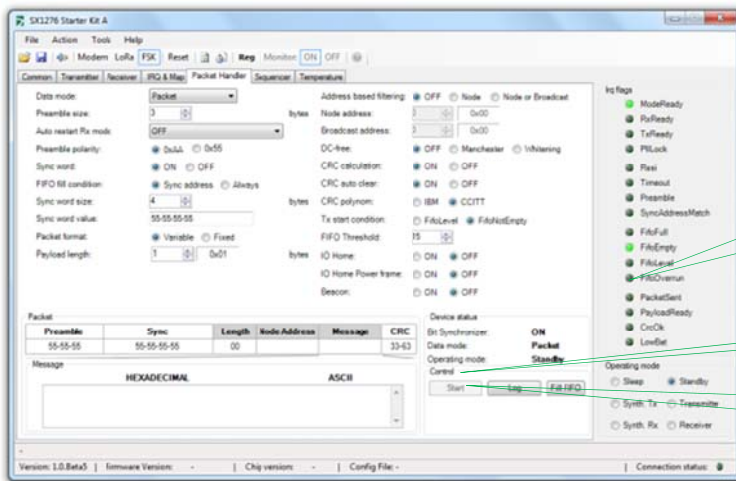

Notice the green LED indicating when a packet is sent

Press “Start” to start sending packets

Press “Stop” to stop sending packets

The device is now sending packet. You can also see the Yellow LED flashing on the Eiger modules to indicate that the device is currently transmitting.

WIRELESS, SENSING & TIMING PRODUCTS

We must now configure the receiver side. Open a new window of the SX1276SKA and configure the radio as done for the transmitter side. The process is identical:

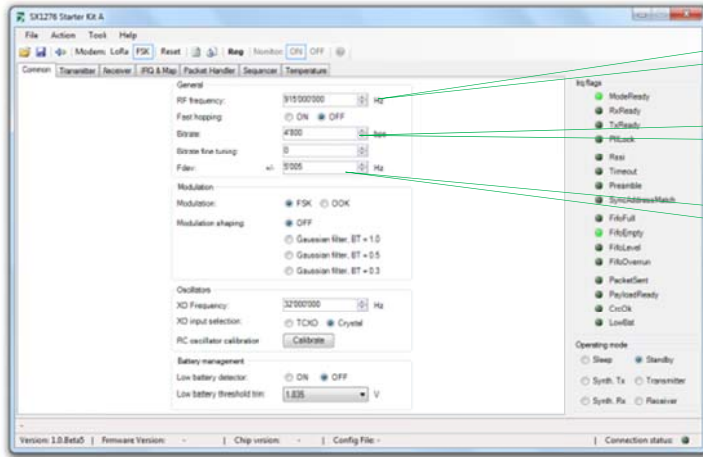

Set the frequency: 915,000,000 Hz

Set the bitrate: 19,200 bps

Set the Frequency deviation: 50,000 Hz

In the receiver, it is necessary to set some parameters to configure the receiver.

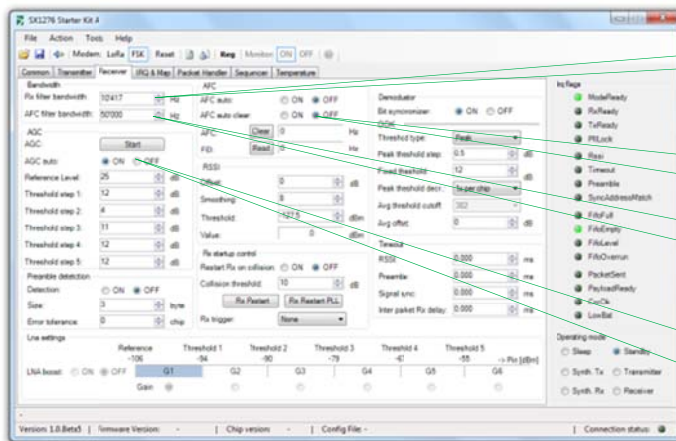

Set the Rx Bandwidth: 100,000 Hz

Set the AFC Auto: ON
Set the AFC Auto clear: ON

Set the Frequency deviation: 50,000 Hz

Set AGC Auto: ON

WIRELESS, SENSING & TIMING PRODUCTS

To finish, the user must simply set the packet handler parameters as in Tx:

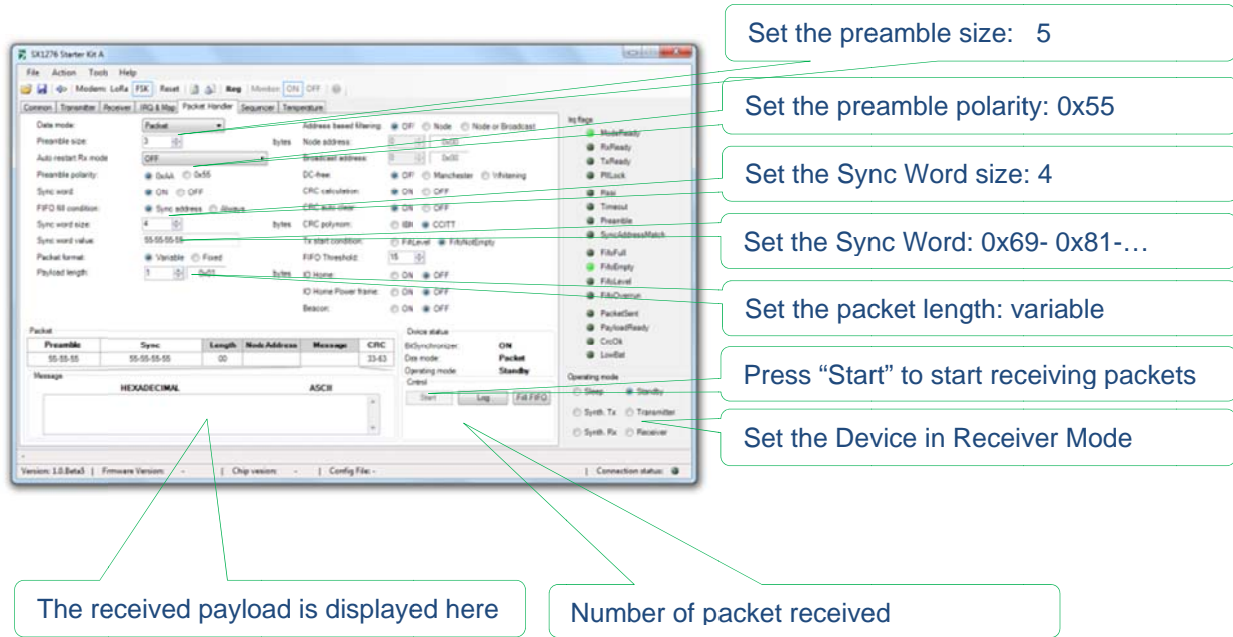

The screenshot shows the 'Packet Handler' configuration window of the SX1276 Starter Kit A software. The interface includes various settings for data mode, preamble, sync word, and packet length. A table at the bottom shows the received packet details, and a 'Start' button is visible in the bottom right corner.

Configuration steps indicated by callouts:

- Set the preamble size: 5
- Set the preamble polarity: 0x55
- Set the Sync Word size: 4
- Set the Sync Word: 0x69- 0x81-...
- Set the packet length: variable
- Press "Start" to start receiving packets
- Set the Device in Receiver Mode

Additional callouts:

- The received payload is displayed here
- Number of packet received

Preamble	Sync	Length	Node Address	Message	CRC
55-55-55	55-55-55-55	00			33-43

7.3 ... perform Continuous transmission and Reception in LoRa

It is possible to set the SX1276 in Continuous Tx mode to perform a spectral evaluation of the LoRa modulation. In this mode, the SX1276 will be going through the FiFo and send whatever data are present in the RAM.

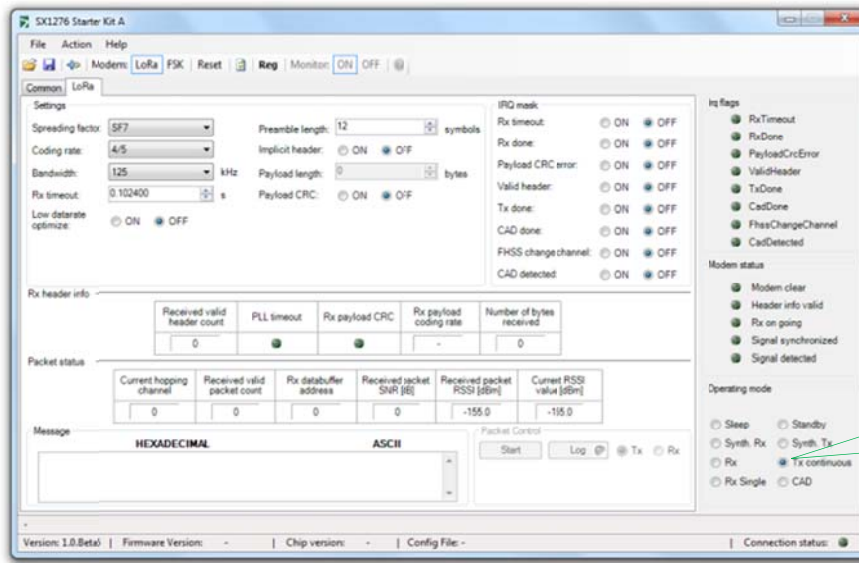

It is also possible to set the device in Continuous Rx mode. In this mode, the device is continuously receiving the packet sent from the transmitter.

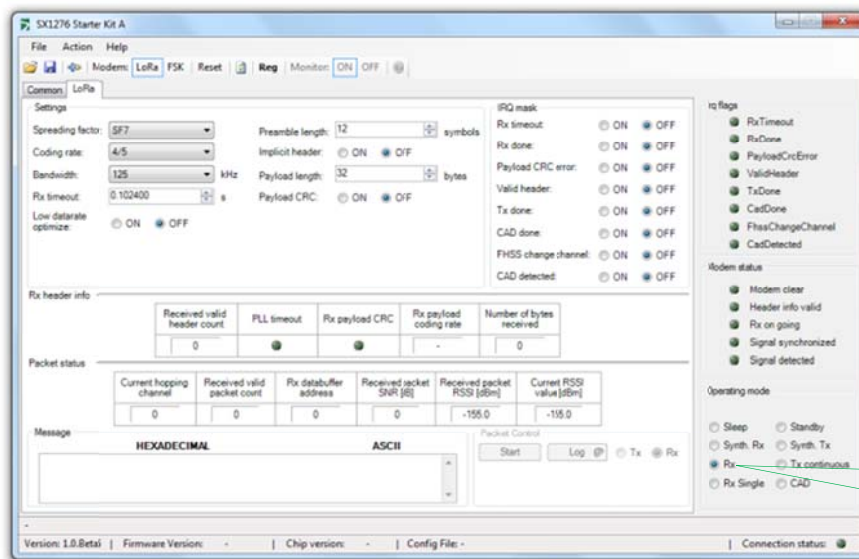

7.4 ... Log the Transmitted or Received packets

The SX1276SKA has a logging facility which allows the user to get the exact time stamps at which a packet has been sent or received and with all the information related to this packet.

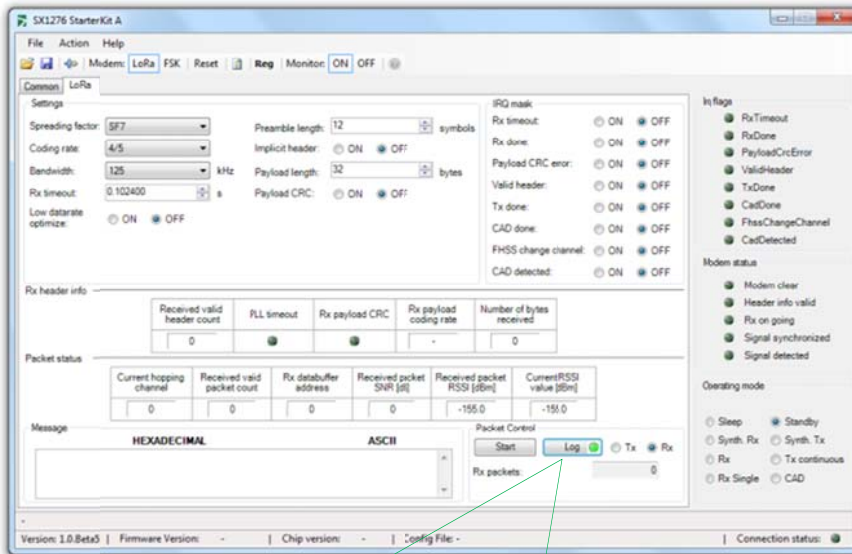

Start the Logging of the transmitted or received packets

Depending if you are in FSK mode or in LoRa mode, a different pop-up window will appear:

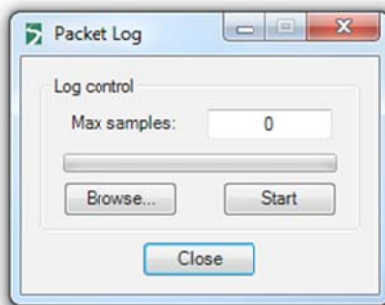

In FSK mode, the packet logger allows to the user to only log a limited amount of packet (indicated by the value "Max Samples"). Then, when the packets are being transmitted or received, the number of desired packets will be logged in the file selected.

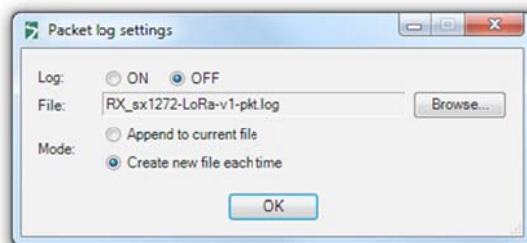

In LoRa mode, the packet logger is enabled or disabled. Once enabled, all transmitted or received packets will be logged in the selected file until the packet logger is disabled.

When enabling the packet logger, it is possible to start a complete new log in a new file or to append an existing file.

7.5 ... perform a CW or PN9 Tx test on the SX1276

The SX1276 does not have a dedicated CW or PN9 Tx test mode implemented. However, it is possible to perform this test manually by setting the device in Tx continuous mode, and feed PN9/15 data stream to the DATA pin (DIO2/DATA), from a signal generator.

7.6 ... check the frequency accuracy of the SX1276 module

There is a very simple way to get the frequency error of the sx1276 modules. The core idea is to set the device in FSK and to set the frequency deviation to 0. In this case, the device will only emit a signal at the center frequency. The difference between the measured value and the set value gives you the frequency error.

8 Troubleshooting

Each Eiger platform, radio module or software kit has been thoroughly tested before to be released for customer evaluation. The section below highlights some of the common issues faced by users and how it can be fixed.

8.1 The Eiger platform indicates very high PER even in short range

There are several reasons which can have a dramatic influence over the performance of the platform. One of the common reasons is that the frequency selected is in the GSM or in another already used frequency band. If the frequency you have selected is already used by another RF system, the communication will obviously be affected. We therefore recommend to the user to check the RF band usage in his location before to start any PER testing.

8.2 The communication range in Lora is very poor

There are two aspects which can limit the LoRa performances: the emission power and the antenna. Please, make sure that we are using enough power to reach the distance you want to achieve. The Eiger platform can output up to 20dBm signals. The other aspect is the antenna, please, make sure the antenna you are using is designed to operate at the frequency region you are transmitting in.

8.3 The SX1276SKA do not detect the device through the USB

This issue is usually caused by a wrong connection of the USB
The step below should fix the issue.

- 1- Make sure the Eiger Platform is powered down (Battery switch set to 0) and is not connected to the PC through the USB.
- 2- Reconnect the side USB to the PC, the red LED on the left side should light up
- 3- Connect the bottom USB to the PC.
- 4- Power the device up (Battery switch set to 1)
- 5- Press the five-way central push button until the screen light up.
- 6- Launch the SX1276SKA on the PC

8.4 The Eiger platform does not seem to work anymore

The battery is probably empty and you should connect the device through the side USB to a computer for a few hours, time for the battery to charge.

8.5 The Eiger platform touch screen is not accurate

This is probably due to a miss-calibration of the touch screen. In this situation, the user should reset the touch screen calibration and perform an accurate calibration using the stylus provided.