

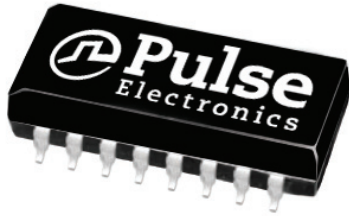





Copperhead™ High Speed Dual Transformers



-  Compliant with ANSI X3T111, Fiber Channel, FC-PH-3 for quarter/full speed applications, SMPTE, IEEE1394 Firewire
-  Moisture sensitivity Level 3
-  Pick and place compatible
-  Peak temperature profile 250°C; NL parts peak temperature is 245°C.
-  AS9100 Certified (Based on and including ISO 9001:2000)

Electrical Specifications @ 25°C - Operating Temperature -55°C to +125°C

Part Number	Turns Ratio (±5%)	Primary Inductance (μH MIN)	Rise Time @ 20 & 80% (pS MAX)	DC Resistance (ΩMAX)	Hi-Pot (Vrms MIN)	Insertion Loss (dB MAX)	Application Nominal Bit Rate (Mbaud)
T-330SCT	1CT : 1CT	26 @ 1 Vrms, 100kHz	350	0.2	1,500	-1.5 @ 15-165MHz	265.6 (1/4 speed)
T-531SCT	1CT : 1CT	7.5 @ 1 Vrms, 100kHz	325	0.2	1,500	-2.0 @ 50-265MHz	531 (half speed)
T-1062SCT	1CT : 1CT	3.75 @ 1 Vrms, 100kHz	280	0.2	1,500	-2.0 @ 100-531MHz	1,062.5 (full speed)
T-1250SCT	1CT : 1CT	3.75 @ 1 Vrms, 100kHz	280	0.2	1,500	-2.0 @ 125-650MHz	1,250
T-1485SCT	1CT : 1CT	3.75 @ 1 Vrms, 100kHz	280	0.2	1,500	-2.0	1,485 (SMTPE)
T-3200SCT	1 : 1	0.70	200	0.2	1,500	-4.5	3,200

Notes:

1. To order a RoHS compliant part, add the suffix "NL" to the part number, i.e. T-330SCT becomes T-330SCTNL.
2. Add suffix "T" to part number for Tape & Reel package (i.e. T-330SCTT).

Mechanical

Schematic

T-330SCT, T-531SCT, T-1062SCT, T1250SCT and T-1485SCT

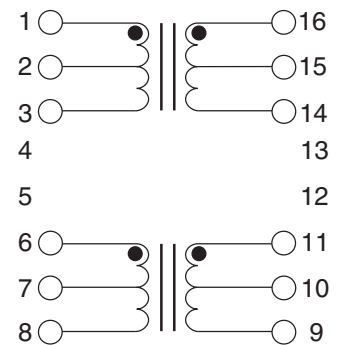
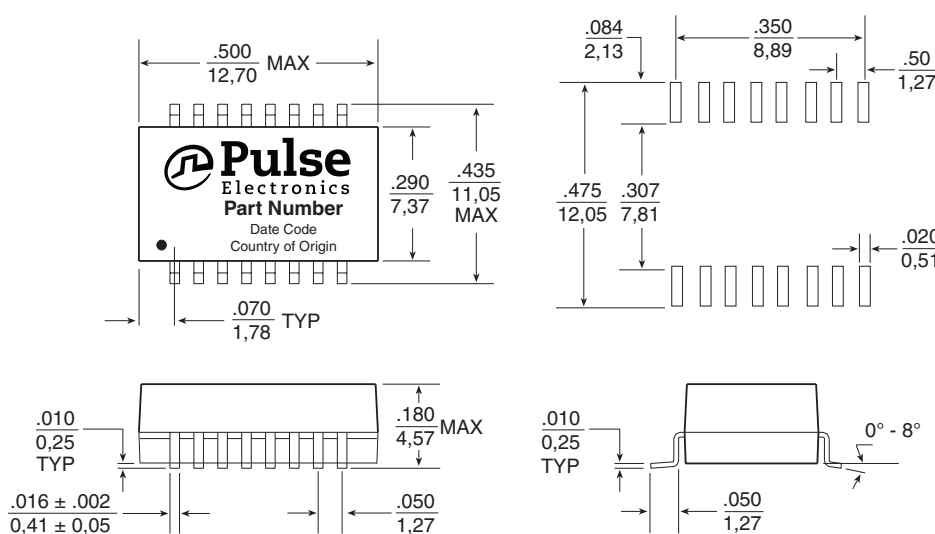

Weight 1.0 grams
 Tape & Reel 400/reel
 Dimensions: $\frac{\text{Inches}}{\text{mm}}$
 Unless otherwise specified,
 all tolerances are $\pm \frac{.005}{0,13}$

Copperhead™ High Speed Dual Transformers

Mechanical

Schematic

T-3200SCT

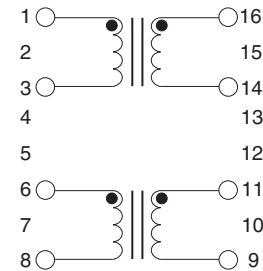
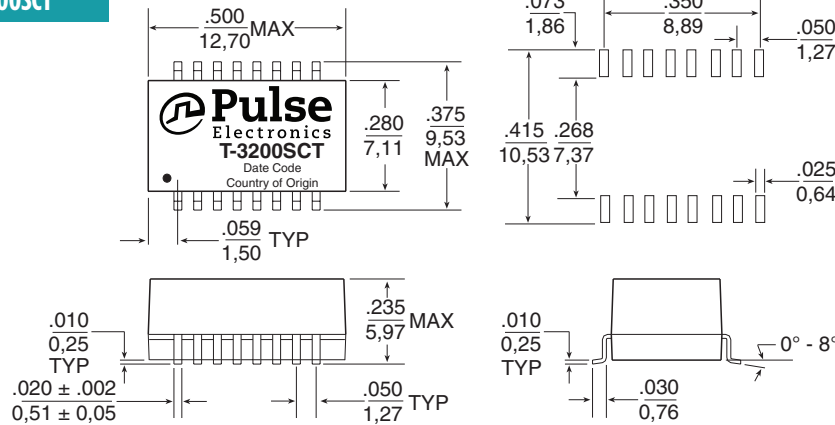

Weight 1.0 grams
Tape & Reel 600/reel
Dimensions: Inches
mm
Unless otherwise specified,
all tolerances are ± .005
0,13

Application

Pulse Specialty Components has designed Fibre Channel dual transformers specifically for point to point coupling to 150 twinax cable. The isolation transformers protect the station from static charges that may develop on the cable, and prevents ground loop currents from being transferred between stations. The devices have also been designed to provide common mode rejection within the transmission band and thus reduce EMI. The wide bandwidth of these

devices minimizes data dependent jitter by providing fast signal rise times. Low-end bandwidth also minimizes base-line wander, another contributor to jitter. The dual package allows connection of both transmit and receive channels, as shown in the application circuit below. Surface-mount packaging also allows a cost-effective solution.

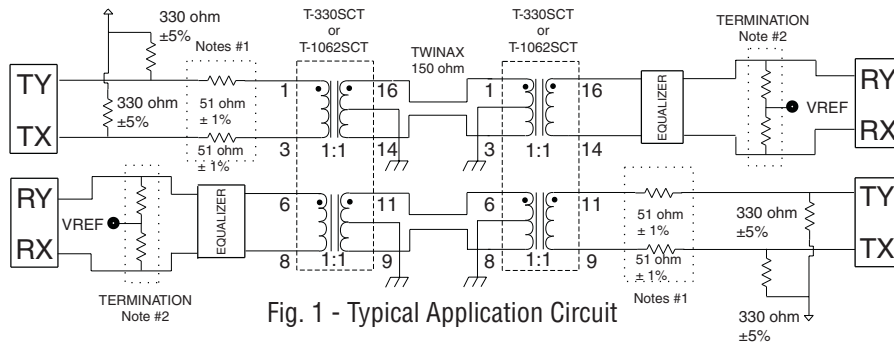

1. The transformer, 51 Ω resistors, and the impedance of the driver are matched to achieve the best return loss (S11) for the transmitter of the 150 Ω system.
2. The total impedance of termination resistor network is 150 Ω.
3. When laying out PCB, transmission line methods must be utilized to maintain return loss and signal integrity. Transformer must be located within .50 of the DB9

4. It is recommended that the center tap (CT) of transformer(s), cable side, be connected to earth/chassis (cable shield) ground either directly or via a transient voltage suppressor (TVS) type component and earth/chassis ground should be "AC-coupled" to signal (digital) ground through a 0.27uF, 500v capacitor.

For More Information

Pulse Worldwide Headquarters
12220 World Trade Drive
San Diego, CA
92128
U.S.A.

Pulse Europe
Einsteinstrasse 1
D-71083 Herrenberg
Germany

Pulse China Headquarters
B402, Shenzhen Academy of
Aerospace Technology Bldg.
10th Kejinan Road
High-Tech Zone
Nanshan District
Shenzhen, PR China
518057

Pulse North China
Room 2704/2705
Super Ocean Finance
Ctr.
2067 Yan An Road
West
Shanghai 200336
China

Pulse South Asia
135 Joo Seng Road
#03-02
PM Industrial Bldg.
Singapore 368363

Pulse North Asia
3F, No. 198
Zhongyuan Road
Zhongli City
Taoyuan County 320
Taiwan R. O. C.
Tel: 886 3 4356768
Fax: 886 3 4356823
(Pulse)

Tel: 858 674 8100

Tel: 49 7032 7806

Tel: 65 6287 8998
Fax: 65 6287 8998

Performance warranty of products offered on this data sheet is limited to the parameters specified. Data is subject to change without notice. Other brand and product names mentioned herein may be trademarks or registered trademarks of their respective owners. © Copyright, 2014. Pulse Electronics, Inc. All rights reserved.