

10A, 600V - 1000V Standard Bridge Rectifier

FEATURES

- Glass passivated chip junction
- Ideal for printed circuit board
- High surge current capability
- UL Recognized File # E-326243
- RoHS Compliant
- Halogen-free according to IEC 61249-2-21

APPLICATIONS

- Switching mode power supply (SMPS)
- Adapters
- Lighting application

MECHANICAL DATA

- Case: TS-6PL
- Molding compound meets UL 94V-0 flammability rating
- Terminal: Matte tin plated leads, solderable per J-STD-002
- Meet JESD 201 class 1 whisker test
- Mounting torque: 0.78 N·m maximum
- Polarity: As marked
- Weight: 4.40g (approximately)

KEY PARAMETERS		
PARAMETER	VALUE	UNIT
I_F	10	A
V_{RRM}	600 - 1000	V
I_{FSM}	144	A
$T_{J\ MAX}$	150	°C
Package	TS-6PL	
Configuration	Quad	

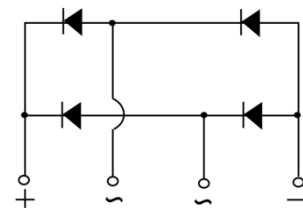
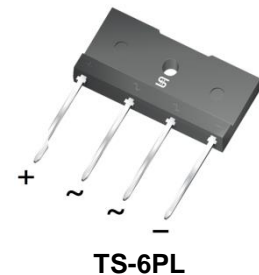

ABSOLUTE MAXIMUM RATINGS ($T_A = 25^\circ\text{C}$ unless otherwise noted)					
PARAMETER	SYMBOL	T10JA05G-K	T10JA06G-K	T10JA07G-K	UNIT
Marking code on the device		T10JA05G	T10JA06G	T10JA07G	
Repetitive peak reverse voltage	V_{RRM}	600	800	1000	V
Reverse voltage, total rms value	$V_{R(RMS)}$	420	560	700	V
Forward current	I_F	10			A
Peak forward surge current, single half sine-wave superimposed on rated load	$t = 8.3\text{ms}$	144			A
	$t = 1.0\text{ms}$	436			A
Rating of fusing ($t < 8.3\text{ms}$)	I^2t	86			A^2s
Junction temperature	T_J	- 55 to +150			°C
Storage temperature	T_{STG}	- 55 to +150			°C

THERMAL PERFORMANCE			
PARAMETER	SYMBOL	TYP	UNIT
Junction-to-lead thermal resistance	$R_{\theta JL}$	11	°C/W
Junction-to-ambient thermal resistance	$R_{\theta JA}$	17	°C/W
Junction-to-case thermal resistance	$R_{\theta JC}$	6	°C/W

Thermal Performance Note: Mounted on heat sink size of 4" x 6" x 0.25" Al-plate

ELECTRICAL SPECIFICATIONS ($T_A = 25^\circ\text{C}$ unless otherwise noted)					
PARAMETER	CONDITIONS	SYMBOL	TYP	MAX	UNIT
Forward voltage per diode ⁽¹⁾	$I_F = 5\text{A}, T_J = 25^\circ\text{C}$	V_F	0.93	-	V
	$I_F = 10\text{A}, T_J = 25^\circ\text{C}$		1.01	1.10	V
	$I_F = 5\text{A}, T_J = 125^\circ\text{C}$		0.83	-	V
	$I_F = 10\text{A}, T_J = 125^\circ\text{C}$		0.92	1.03	V
Reverse current @ rated V_R per diode ⁽²⁾	$T_J = 25^\circ\text{C}$	I_R	-	5	μA
	$T_J = 125^\circ\text{C}$		-	300	μA
Junction capacitance per diode	1MHz, $V_R = 4.0\text{V}$	C_J	43.9	-	pF

Notes:

1. Pulse test with PW = 0.3ms
2. Pulse test with PW = 30ms

ORDERING INFORMATION		
ORDERING CODE⁽¹⁾	PACKAGE	PACKING
T10JA0xG-K	TS-6PL	15 / Tube

Notes:

1. "x" defines voltage from 600V(T10JA05G-K) to 1000V(T10JA07G-K)

CHARACTERISTICS CURVES

($T_A = 25^\circ\text{C}$ unless otherwise noted)

Fig.1 Forward Current Derating Curve

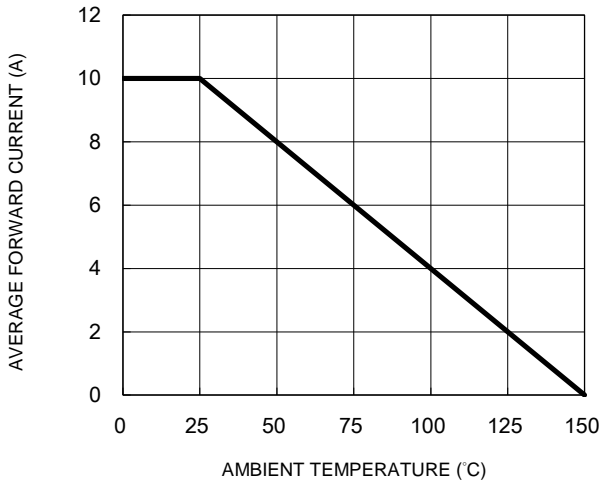

Fig.2 Typical Junction Capacitance

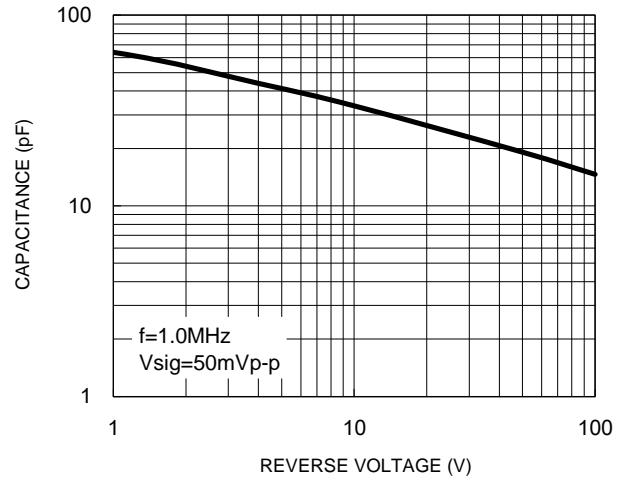

Fig.3 Typical Reverse Characteristics

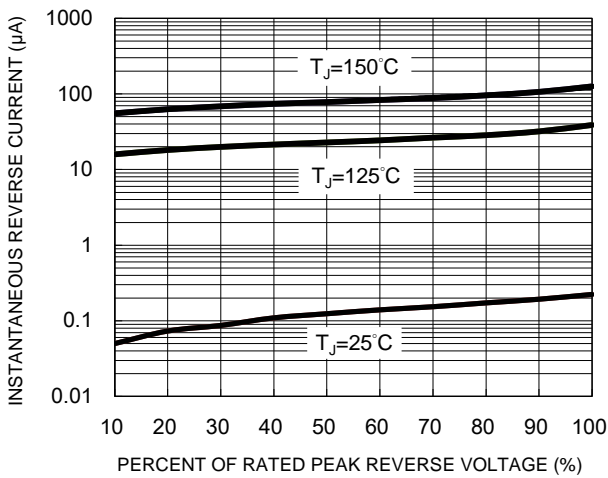
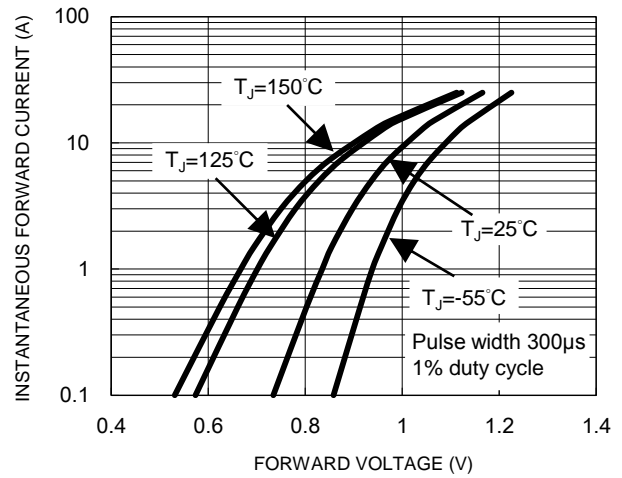
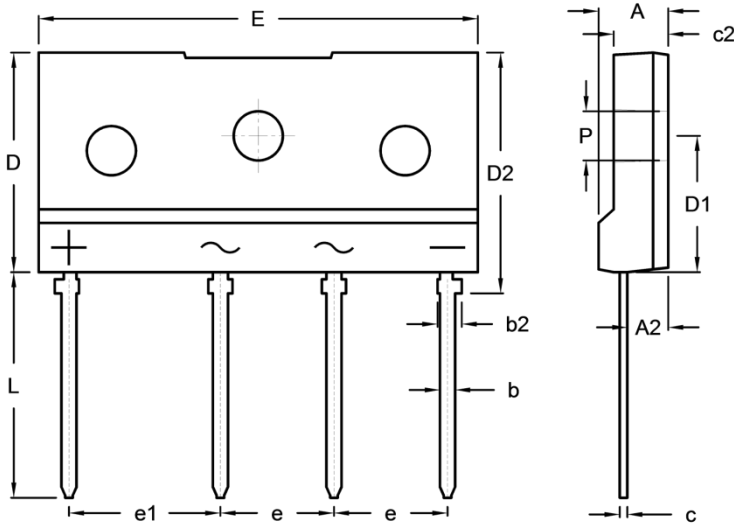

Fig.4 Typical Forward Characteristics



PACKAGE OUTLINE DIMENSIONS

TS-6PL



DIM.	Unit (mm)		Unit (inch)	
	Min.	Max.	Min.	Max.
A	4.30	4.90	0.169	0.193
A2	2.50	2.90	0.098	0.114
b	0.90	1.10	0.035	0.043
b2	1.50	1.70	0.059	0.067
c	0.40	0.60	0.016	0.024
c2	3.30	3.90	0.130	0.154
D	14.20	14.80	0.559	0.583
D1	8.70	9.30	0.343	0.366
D2	15.60	16.20	0.614	0.638
E	28.70	29.30	1.130	1.154
e	7.30	7.70	0.287	0.303
e1	9.80	10.20	0.386	0.402
L	14.60	15.20	0.575	0.598
P	3.10	3.40	0.122	0.134

MARKING DIAGRAM

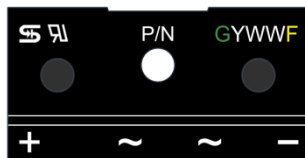

- P/N = Marking Code
- G = Green Compound
- YWW = Date Code
- F = Factory Code