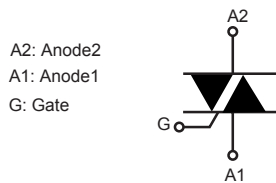
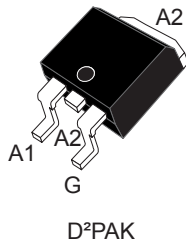

12 A - 800 V logic level T-series Triac in D<sup>2</sup>PAK

## Product status link

[T1210T-8G](#)

## Product summary

$I_{T(RMS)}$	12 A
$V_{DRM}/V_{RRM}$	800 V
$V_{DSM}/V_{RSM}$	900 V
$I_{GT}$	10 mA

## Features

- 150 °C maximum junction temperature
- Three quadrants
- High commutation on resistive loads
- Surge capability  $V_{DSM}$ ,  $V_{RSM} = 900$  V
- Benefits:
  - Easy direct control by MCU thanks to low 10 mA  $I_{GT}$
  - Increase of thermal margin due to extended working  $T_j$  up to 150 °C
  - Ability to turn off resistive surges of 28 A

## Applications

- General purpose AC line load switching
- Small home appliances with resistive loads
- Hybrid relays
- Inrush current limiting circuits
- Overvoltage crowbar protection

## Description

The SMD T1210T-8G Triac can be used for the on/off or phase angle control function in general purpose AC switching with resistive loads. A Logic level T-series Triac, the T1210T-8G can be controlled directly from an MCU with a simplified circuit.

T-series triacs are optimized for high EMI constraints. The surface mount D<sup>2</sup>PAK package enables compact SMT designs for automated manufacturing.

D<sup>2</sup>PAK package's molding compound resin is halogen-free and meets UL94 flammability standard level V0.

Package environmentally friendly **Ecopack2** graded (RoHS and Halogen Free compliance).

# 1 Characteristics

**Table 1. Absolute maximum ratings (limiting values),  $T_j = 25\text{ °C}$  unless otherwise specified**

Symbol	Parameter		Value	Unit
$V_{DRM}/V_{RRM}$	Repetitive peak off-state voltage (50-60 Hz)	$T_j = 125\text{ °C}$	800	V
		$T_j = 150\text{ °C}$	600	V
$V_{DSM}/V_{RSM}$	Non Repetitive peak off-state voltage	$t_p = 10\text{ ms}$ , $T_j = 25\text{ °C}$	900	V
$I_{T(RMS)}$	RMS on-state current (full sine wave)	$T_c = 131\text{ °C}$	12	A
$I_{TSM}$	Non repetitive surge peak on-state current (full cycle, $T_j$ initial = $25\text{ °C}$ )	$t = 16.7\text{ ms}$	105	A
		$t = 20\text{ ms}$	100	
$I^2t$	$I^2t$ value for fusing	$t_p = 10\text{ ms}$	66	$A^2s$
$di/dt$	Critical rate of rise of on-state current, $I_G = 2 \times I_{GT}$ , $tr \leq 100\text{ ns}$	$f = 100\text{ Hz}$	100	$A/\mu s$
$I_{GM}$	Peak gate current	$t_p = 20\text{ }\mu s$ , $T_j = 150\text{ °C}$	4	A
$V_{GM}$	Peak Gate Voltage		5	V
$P_{G(AV)}$	Average gate power dissipation	$T_j = 150\text{ °C}$	1	W
$T_{stg}$	Storage junction temperature range		-40 to +150	$^{\circ}C$
$T_j$	Operating junction temperature range		-40 to +150	$^{\circ}C$

**Table 2. Electrical characteristics ( $T_j = 25\text{ °C}$ , unless otherwise specified)**

Symbol	Test conditions	Quadrants; $T_j$		Value	Unit
$I_{GT}^{(1)}$	$V_D = 12\text{ V}$ , $R_L = 30\text{ }\Omega$	I - II - III	Max.	10	mA
$V_{GT}$	$V_D = 12\text{ V}$ , $R_L = 30\text{ }\Omega$	I - II - III	Max.	1	V
$V_{GD}$	$V_D = 800\text{ V}$ , $R_L = 3.3\text{ k}\Omega$ $T_j = 125\text{ °C}$	I - II - III	Min.	0.15	V
$I_L$	$I_G = 1.2 \times I_{GT}$	I - III	Max.	30	mA
	$I_G = 1.2 \times I_{GT}$	II	Max.	35	mA
$I_H^{(2)}$	$I_T = 500\text{ mA}$ , gate open		Max.	25	mA
$dV/dt^{(2)}$	$V_D = 536\text{ V}$ , gate open	$T_j = 125\text{ °C}$	Min.	200	$V/\mu s$
	$V_D = 402\text{ V}$ , gate open	$T_j = 150\text{ °C}$	Min.	150	$V/\mu s$
$(di/dt)_c^{(2)}$	$(dV/dt)_c = 0.1\text{ V}/\mu s$	$T_j = 125\text{ °C}$	Min.	20	A/ms
		$T_j = 150\text{ °C}$		14.4	
	$(dV/dt)_c = 10\text{ V}/\mu s$	$T_j = 125\text{ °C}$	Min.	6	A/ms
		$T_j = 150\text{ °C}$		3.8	

1. Minimum  $I_{GT}$  is guaranteed at 5% of  $I_{GT\text{ max}}$
2. For both polarities of A2 referenced to A1.

**Table 3. Static characteristics**

Symbol	Test conditions	$T_j$		Value	Unit
$V_{TM}^{(1)}$	$I_T = 16.9\text{ A}$ , $t_p = 380\ \mu\text{s}$	25 °C	Max.	1.55	V
$V_{TO}^{(1)}$	Threshold on-state voltage	150 °C	Max.	0.81	V
$R_D^{(1)}$	Dynamic resistance	150 °C	Max.	40	m $\Omega$
$I_{DRM}/I_{RRM}$	$V_{DRM} = V_{RRM} = 800\text{ V}$	25 °C	Max.	7.5	$\mu\text{A}$
		125 °C		1.0	mA
	$V_{DRM} = V_{RRM} = 600\text{ V}$	150 °C	Max.	3.3	mA

1. For both polarities of A2 referenced to A1.

**Table 4. Thermal resistance**

Symbol	Parameter			Value	Unit
$R_{th(j-c)}$	Junction to case (AC)	D <sup>2</sup> PAK	Max.	1.3	°C/W
$R_{th(j-a)}$	Junction to ambient ( $S_{CU}^{(1)} = 2\text{ cm}^2$ )		Typ.	45	°C/W

1.  $S_{cu}$  : copper pad surface under tab, 35  $\mu\text{m}$  copper thickness on FR4 PCB.

### 1.1 Characteristics (curves)

**Figure 1. Maximum power dissipation versus on-state RMS current**

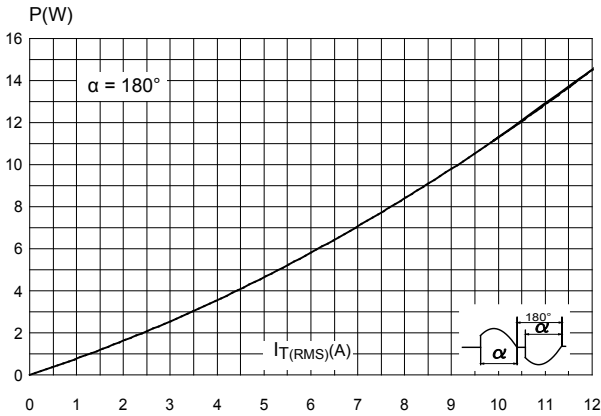

**Figure 2. On-state RMS current versus case temperature**

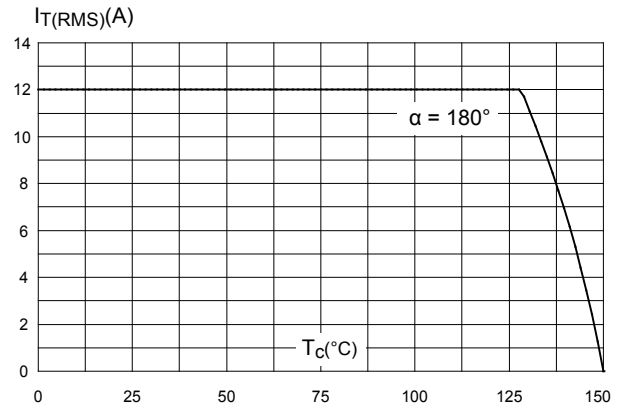

**Figure 3. On-state RMS current versus ambient temperature (free air convection)**

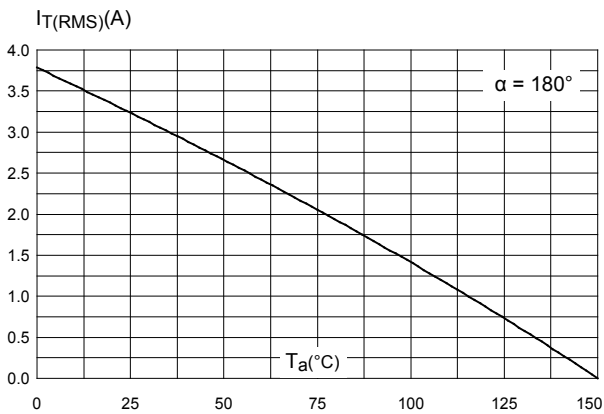

**Figure 4. Relative variation of thermal impedance versus pulse duration**

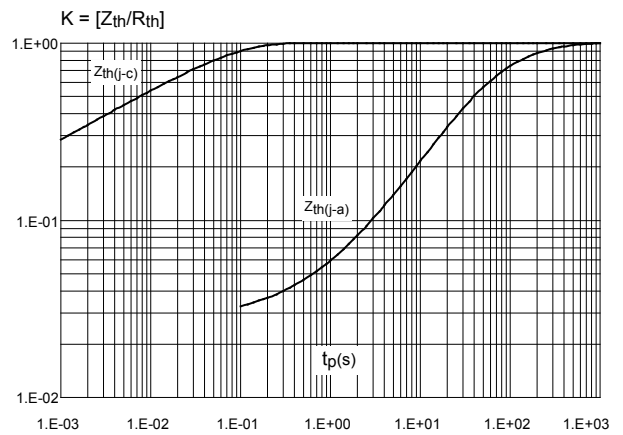

**Figure 5. Relative variation of gate trigger voltage and current versus junction temperature (typical values)**

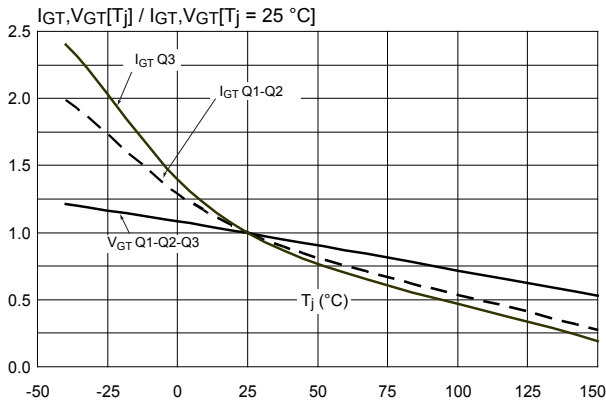

**Figure 6. Relative variation of holding current and latching current versus junction temperature (typical values)**

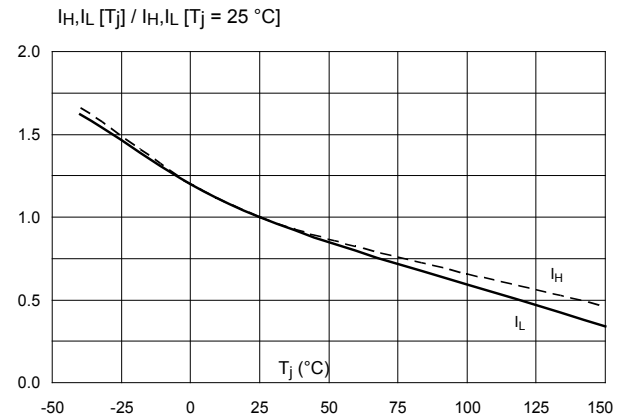

**Figure 7. Surge peak on-state current versus number of cycles**

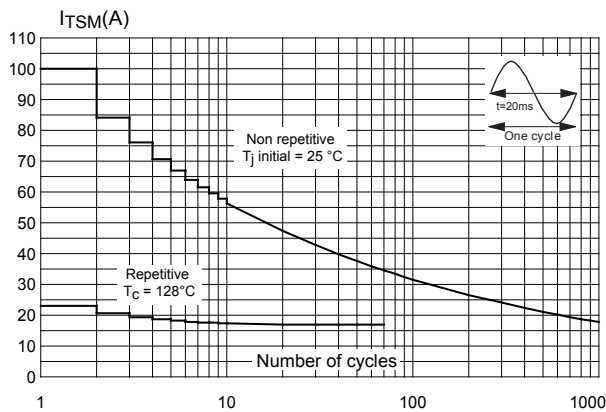

**Figure 8. Non repetitive surge peak on-state current for a sinusoidal pulse with width  $t_p < 10$  ms**

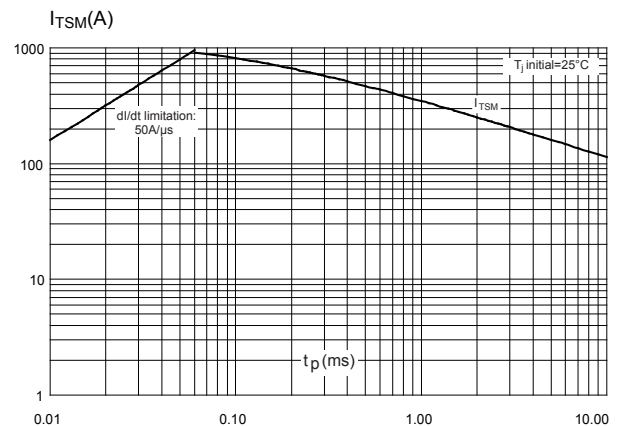

**Figure 9. On-state characteristics (maximum values)**

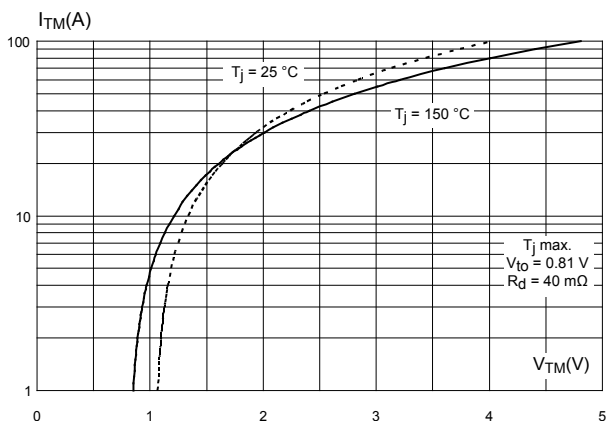

**Figure 10. Relative variation of critical rate of decrease of main voltage versus junction temperature**

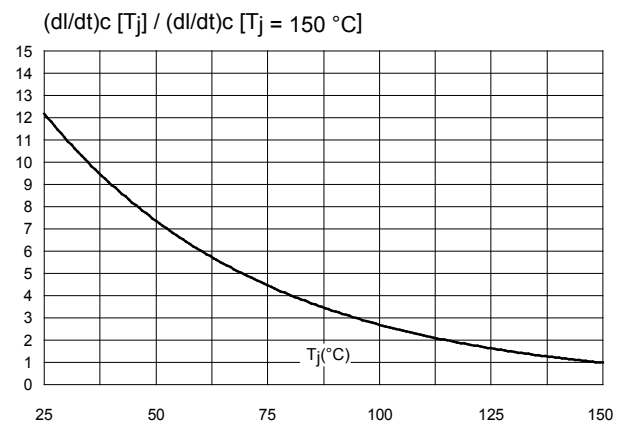

**Figure 11. Relative variation of critical rate of decrease of main current versus reapplied dV/dt (typical values)**

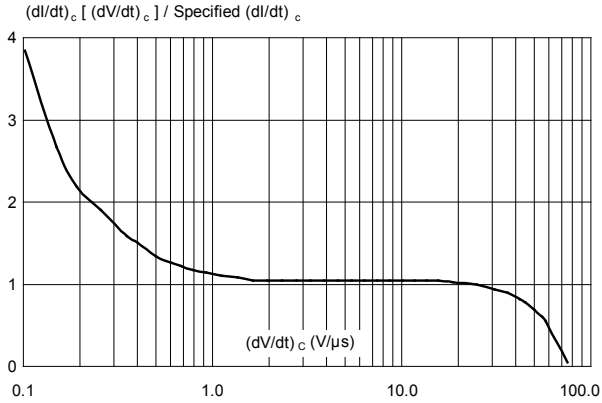

**Figure 12. Relative variation of static dV/dt immunity versus junction temperature**

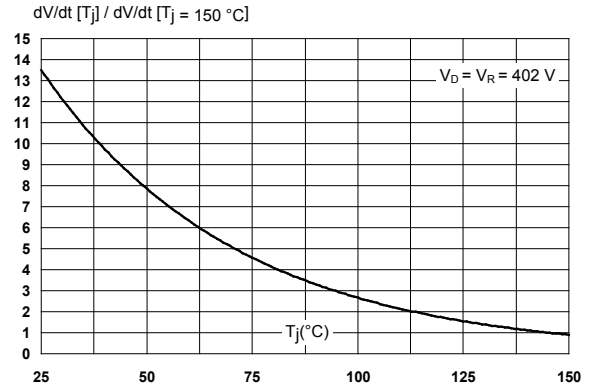

**Figure 13. Relative variation of leakage current versus junction temperature for different values of blocking voltage (typical values)**

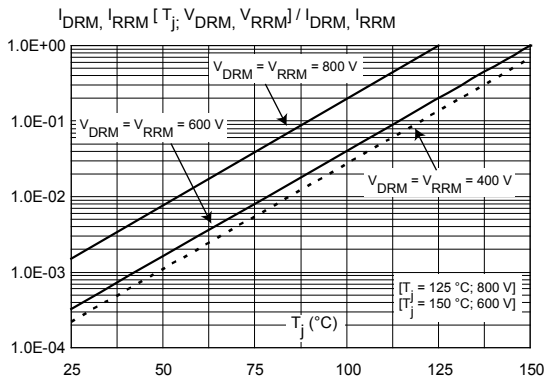

**Figure 14. Thermal resistance junction to ambient versus copper surface under tab**

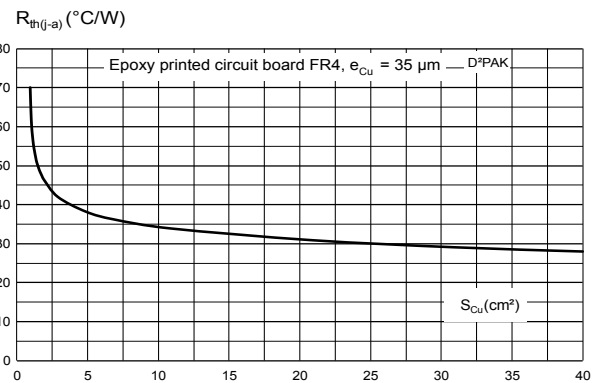

## 2 Package information

In order to meet environmental requirements, ST offers these devices in different grades of **ECOPACK** packages, depending on their level of environmental compliance. ECOPACK specifications, grade definitions and product status are available at: [www.st.com](http://www.st.com). ECOPACK is an ST trademark.

### 2.1 D<sup>2</sup>PAK package information

- ECOPACK2 compliant
- Lead-free package leads finishing
- Molding compound resin is halogen-free and meets UL standard level V0

Figure 15. D<sup>2</sup>PAK package outline

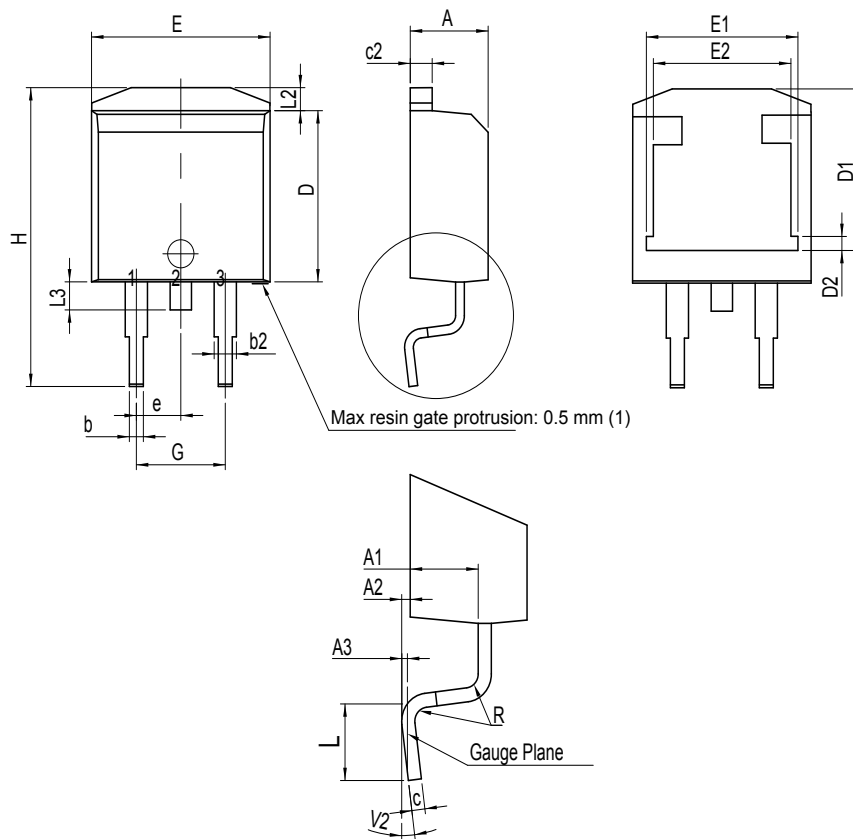

(1) Resin gate is accepted in each of position shown on the drawing, or their symmetrical.

Table 5. D<sup>2</sup>PAK package mechanical data

Ref.	Dimensions					
	Millimeters			Inches <sup>(1)</sup>		
	Min.	Typ.	Max.	Min.	Typ.	Max.
A	4.30		4.60	0.1693		0.1811
A1	2.49		2.69	0.0980		0.1059
A2	0.03		0.23	0.0012		0.0091
A3		0.25			0.0098	
b	0.70		0.93	0.0276		0.0366
b2	1.25		1.7	0.0492		0.0669
c	0.45		0.60	0.0177		0.0236
c2	1.21		1.36	0.0476		0.0535
D	8.95		9.35	0.3524		0.3681
D1	7.50		8.00	0.2953		0.3150
D2	1.30		1.70	0.0512		0.0669
e		2.54			0.1	
E	10.00		10.28	0.3937		0.4047
E1	8.30		8.70	0.3268		0.3425
E2	6.85		7.25	0.2697		0.2854
G	4.88		5.28	0.1921		0.2079
H	15		15.85	0.5906		0.6240
L	1.78		2.28	0.0701		0.0898
L2	1.19		1.40	0.0468		0.0551
L3	1.40		1.75	0.0551		0.0689
R		0.40			0.0157	
V2 <sup>(2)</sup>	0°		8°	0°		8°

1. Dimensions in inches are given for reference only

2. Degrees



Figure 16. D<sup>2</sup>PAK recommended footprint (dimensions are in mm)

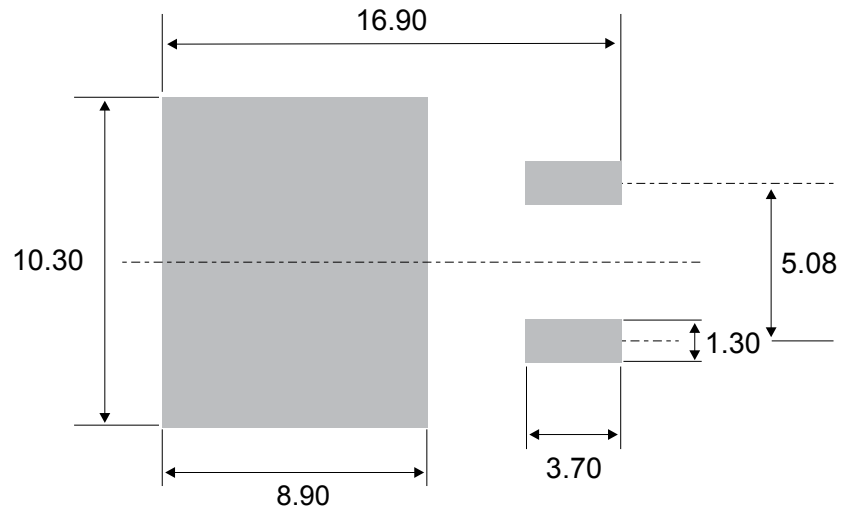
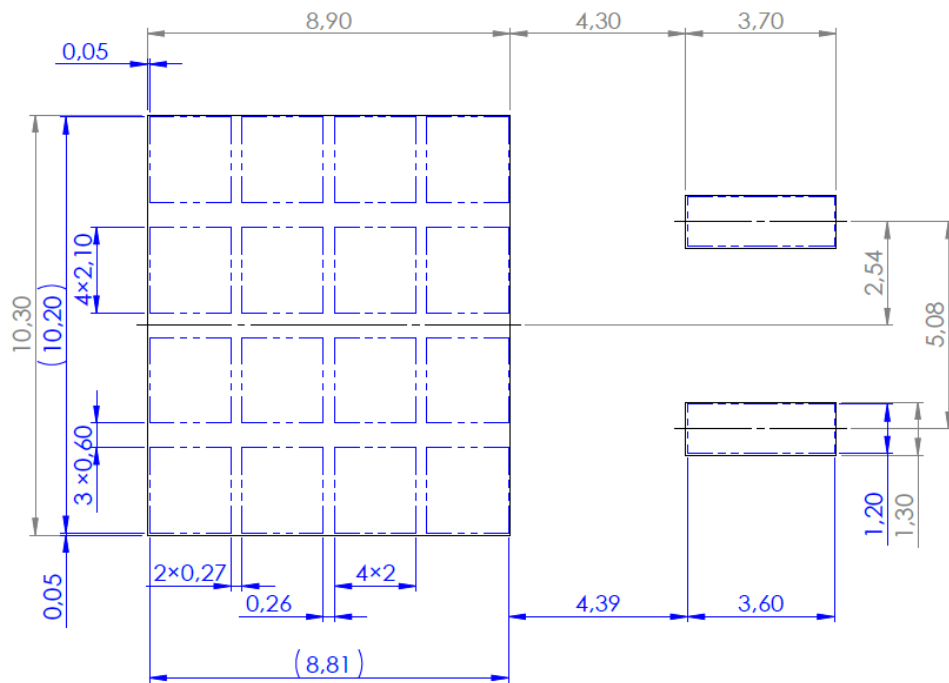

Figure 17. D<sup>2</sup>PAK stencil definitions (dimensions are in mm)



### 3 Ordering information

Figure 18. Ordering information scheme

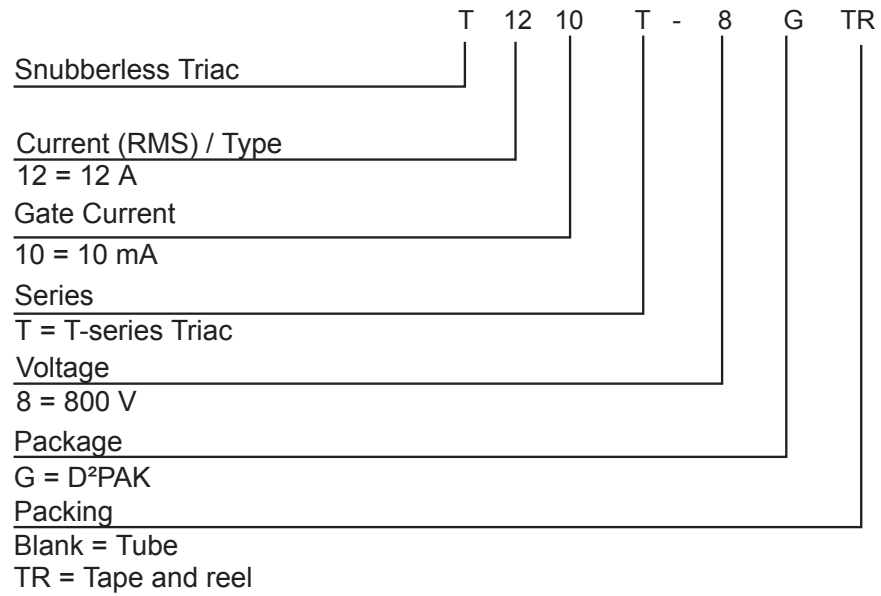

Table 6. Ordering information

Order code	Marking	Package	Weight	Base qty.	Delivery mode
T1210T-8G-TR	T1210T-8G	D <sup>2</sup> PAK	1.6 g	1000	Tape and reel
T1210T-8G				50	Tube

## Revision history

**Table 7. Document revision history**

Date	Version	Changes
05-Aug-2019	1	Initial release.
01-Oct-2019	2	Updated Table 1. Absolute maximum ratings (limiting values), $T_j = 25\text{ }^\circ\text{C}$ unless otherwise specified and Table 4. Thermal resistance.
29-Oct-2020	3	Updated Table 5. D <sup>2</sup> PAK package mechanical data. Minor text changes.