

## 15A, 600V - 1000V Standard Bridge Rectifier

### FEATURES

- Glass passivated chip junction
- Ideal for printed circuit board
- High surge current capability
- UL Recognized File # E-326243
- RoHS Compliant
- Halogen-free according to IEC 61249-2-21

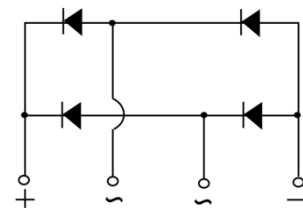
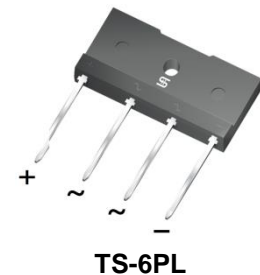
### APPLICATIONS

- Switching mode power supply (SMPS)
- Adapters
- Lighting application

### MECHANICAL DATA

- Case: TS-6PL
- Molding compound meets UL 94V-0 flammability rating
- Terminal: Matte tin plated leads, solderable per J-STD-002
- Meet JESD 201 class 1 whisker test
- Mounting torque: 0.78 N·m maximum
- Polarity: As marked
- Weight: 4.40g (approximately)

KEY PARAMETERS		
PARAMETER	VALUE	UNIT
$I_F$	15	A
$V_{RRM}$	600 - 1000	V
$I_{FSM}$	208	A
$T_{J\ MAX}$	150	°C
Package	TS-6PL	
Configuration	Quad	



ABSOLUTE MAXIMUM RATINGS ( $T_A = 25^\circ\text{C}$ unless otherwise noted)					
PARAMETER	SYMBOL	T15JA05G-K	T15JA06G-K	T15JA07G-K	UNIT
Marking code on the device		T15JA05G	T15JA06G	T15JA07G	
Repetitive peak reverse voltage	$V_{RRM}$	600	800	1000	V
Reverse voltage, total rms value	$V_{R(RMS)}$	420	560	700	V
Forward current	$I_F$	15			A
Peak forward surge current, single half sine-wave superimposed on rated load	$t = 8.3\text{ms}$	208			A
	$t = 1.0\text{ms}$	620			A
Rating of fusing ( $t < 8.3\text{ms}$ )	$I^2t$	180			$\text{A}^2\text{s}$
Junction temperature	$T_J$	- 55 to +150			°C
Storage temperature	$T_{STG}$	- 55 to +150			°C

<b>THERMAL PERFORMANCE</b>			
<b>PARAMETER</b>	<b>SYMBOL</b>	<b>TYP</b>	<b>UNIT</b>
Junction-to-lead thermal resistance	$R_{\theta JL}$	9	°C/W
Junction-to-ambient thermal resistance	$R_{\theta JA}$	14	°C/W
Junction-to-case thermal resistance	$R_{\theta JC}$	5	°C/W

**Thermal Performance Note:** Mounted on heat sink size of 4" x 6" x 0.25" Al-plate

<b>ELECTRICAL SPECIFICATIONS</b> ( $T_A = 25^\circ\text{C}$ unless otherwise noted)					
<b>PARAMETER</b>	<b>CONDITIONS</b>	<b>SYMBOL</b>	<b>TYP</b>	<b>MAX</b>	<b>UNIT</b>
Forward voltage per diode <sup>(1)</sup>	$I_F = 7.5\text{A}, T_J = 25^\circ\text{C}$	$V_F$	0.92	-	V
	$I_F = 15.0\text{A}, T_J = 25^\circ\text{C}$		0.97	1.10	V
	$I_F = 7.5\text{A}, T_J = 125^\circ\text{C}$		0.84	-	V
	$I_F = 15.0\text{A}, T_J = 125^\circ\text{C}$		0.87	0.97	V
Reverse current @ rated $V_R$ per diode <sup>(2)</sup>	$T_J = 25^\circ\text{C}$	$I_R$	-	5	$\mu\text{A}$
	$T_J = 125^\circ\text{C}$		-	275	$\mu\text{A}$
Junction capacitance per diode	1MHz, $V_R = 4.0\text{V}$	$C_J$	61.8	-	pF

**Notes:**

1. Pulse test with PW = 0.3ms
2. Pulse test with PW = 30ms

<b>ORDERING INFORMATION</b>		
<b>ORDERING CODE<sup>(1)</sup></b>	<b>PACKAGE</b>	<b>PACKING</b>
T15JA0xG-K	TS-6PL	15 / Tube

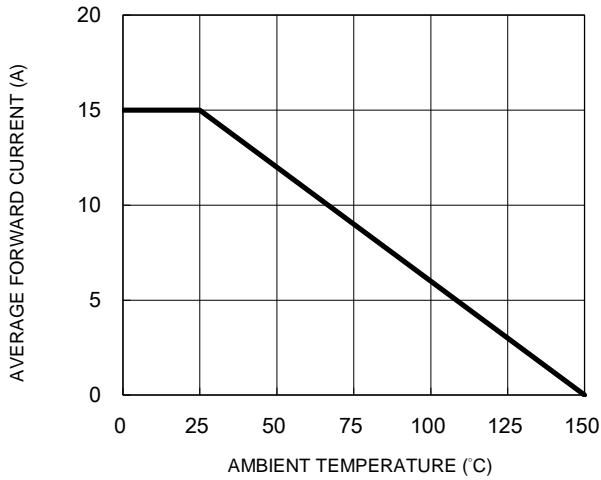
**Notes:**

1. "x" defines voltage from 600V(T15JA05G-K) to 1000V(T15JA07G-K)

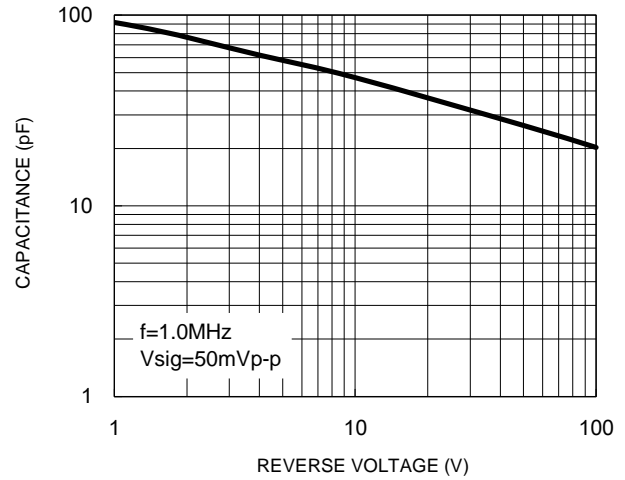
**CHARACTERISTICS CURVES**

( $T_A = 25^\circ\text{C}$  unless otherwise noted)

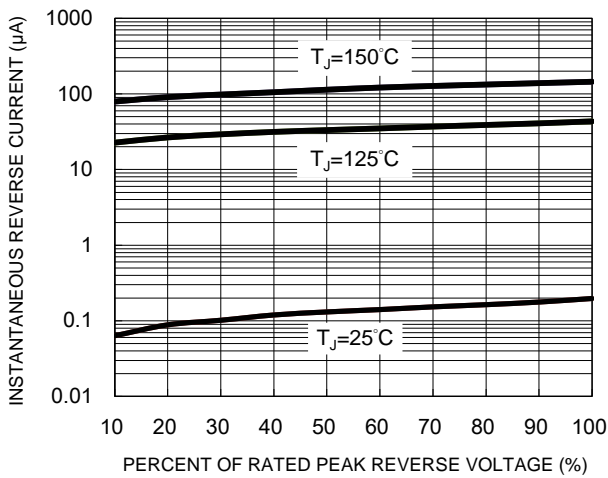
**Fig.1 Forward Current Derating Curve**



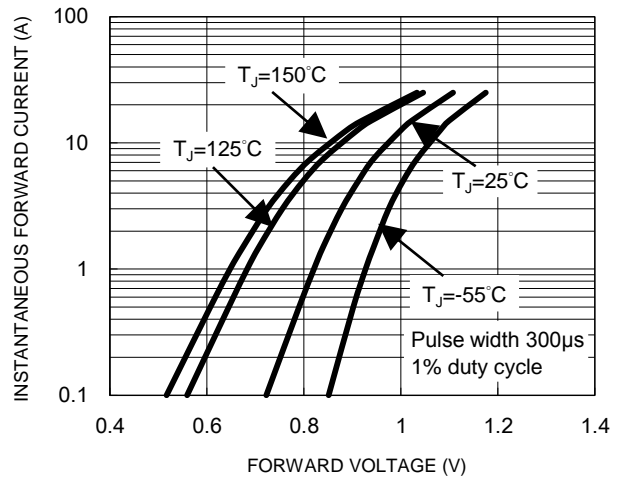
**Fig.2 Typical Junction Capacitance**



**Fig.3 Typical Reverse Characteristics**

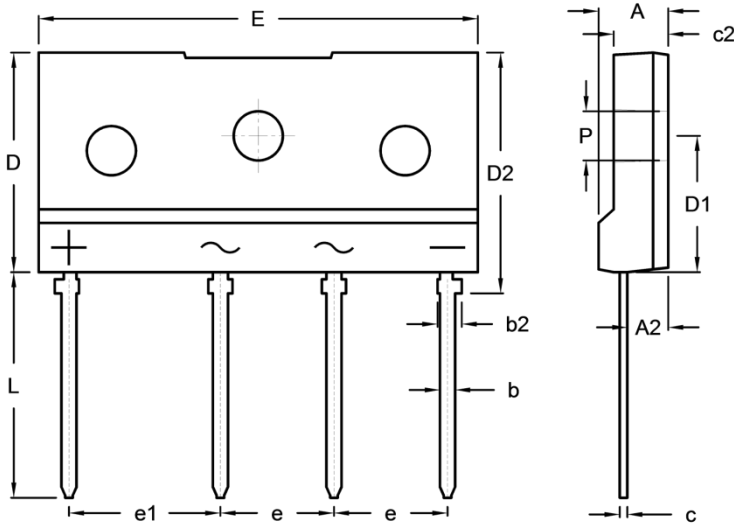


**Fig.4 Typical Forward Characteristics**



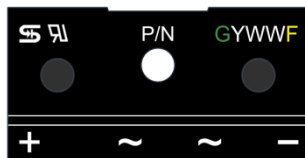
**PACKAGE OUTLINE DIMENSIONS**

TS-6PL



DIM.	Unit (mm)		Unit (inch)	
	Min.	Max.	Min.	Max.
A	4.30	4.90	0.169	0.193
A2	2.50	2.90	0.098	0.114
b	0.90	1.10	0.035	0.043
b2	1.50	1.70	0.059	0.067
c	0.40	0.60	0.016	0.024
c2	3.30	3.90	0.130	0.154
D	14.20	14.80	0.559	0.583
D1	8.70	9.30	0.343	0.366
D2	15.60	16.20	0.614	0.638
E	28.70	29.30	1.130	1.154
e	7.30	7.70	0.287	0.303
e1	9.80	10.20	0.386	0.402
L	14.60	15.20	0.575	0.598
P	3.10	3.40	0.122	0.134

**MARKING DIAGRAM**



- P/N = Marking Code
- G = Green Compound
- YWW = Date Code
- F = Factory Code